



**Committee of Experts on the Transport of Dangerous Goods
and on the Globally Harmonized System of Classification
and Labelling of Chemicals****Sub-Committee of Experts on the Globally Harmonized
System of Classification and Labelling of Chemicals****Thirty-third session**

Geneva, 10-12 July 2017

Item 3 (a) of the provisional agenda

Hazard communication: labelling of small packagings**Labelling of sets or kits****Transmitted by the European Chemical Industry Council (CEFIC) on
behalf of the informal correspondence group*****Introduction**

1. At its thirty-second session, the Sub-Committee noted that the correspondence group suggested some amendments to the proposed third examples illustrating some of the general principles applicable to the labelling of small packagings which have been proposed for inclusion in Annex 7 of the GHS.

**Development of examples for sets or kits (combination
packages)**

2. All recommendations/amendments have been taken into account in the examples, as requested.

Proposal

3. Add two new examples “Labelling of sets or kits” in annex 7 of the GHS as set out hereafter.

* In accordance with the programme of work of the Sub-Committee for 2017–2018 approved by the Committee at its eighth session (see ST/SG/AC.10/C.3/100, paragraph 98 and ST/SG/AC.10/44, para. 14).

Annex

“Examples 10 and 11: Labelling of small packagings - sets or kits

A set or kit is a combination packaging, intended for defined applications. Generally a set or kit contains two or more individual, small removable inner packagings or single compartments. Each inner packaging or compartment could contain different hazardous substances or mixtures.

The number of the inner packagings or single compartments contained within the set or kit relative to the physical size of the outer packaging is an important first step in determining the feasibility of labelling.

Example 10:

The label of the outer packaging of the set or kit has to be divided into as many pieces as are necessary for enabling a presentation of all required labeling elements of each inner packaging containing hazardous substances or mixtures.

The supplier information need only appear once.

Cardboard box containing 4 glass ampoules, each ampoule filled with 3.5 ml of the same substance or mixture, and two bottles each filled with 5 ml of another substance or mixture

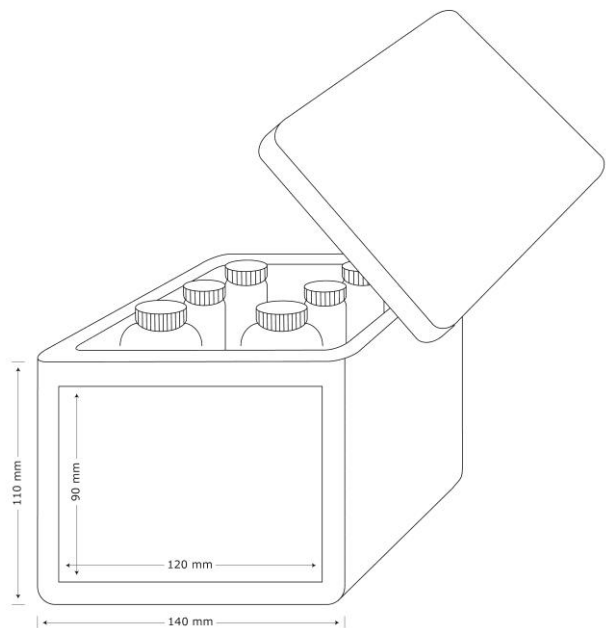
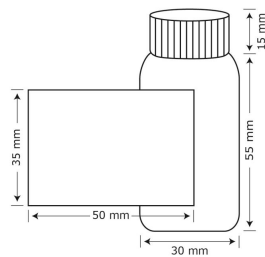
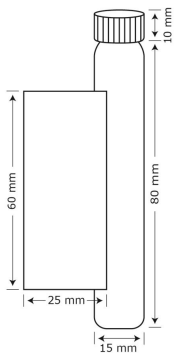

The area available on the outer packaging of the set or kit label is large enough to carry the required GHS label elements:

- set or kit identifier (name of the set or kit)
- supplier information
- storage conditions for the set or kit as a whole
- product identifier of each hazardous substance or mixture
- pictograms of each hazardous substance or mixture
- supplemental information of each hazardous substance or mixture
- precautionary statements of each hazardous single component substance or mixture

If the area available for a label on the different inner packaging is not sufficient to include all required label elements the following minimum required information should be included:

- supplier information
- product identifier
- hazard pictogram(s)
- signal word

“Read outer packaging label”

Inner kit-label

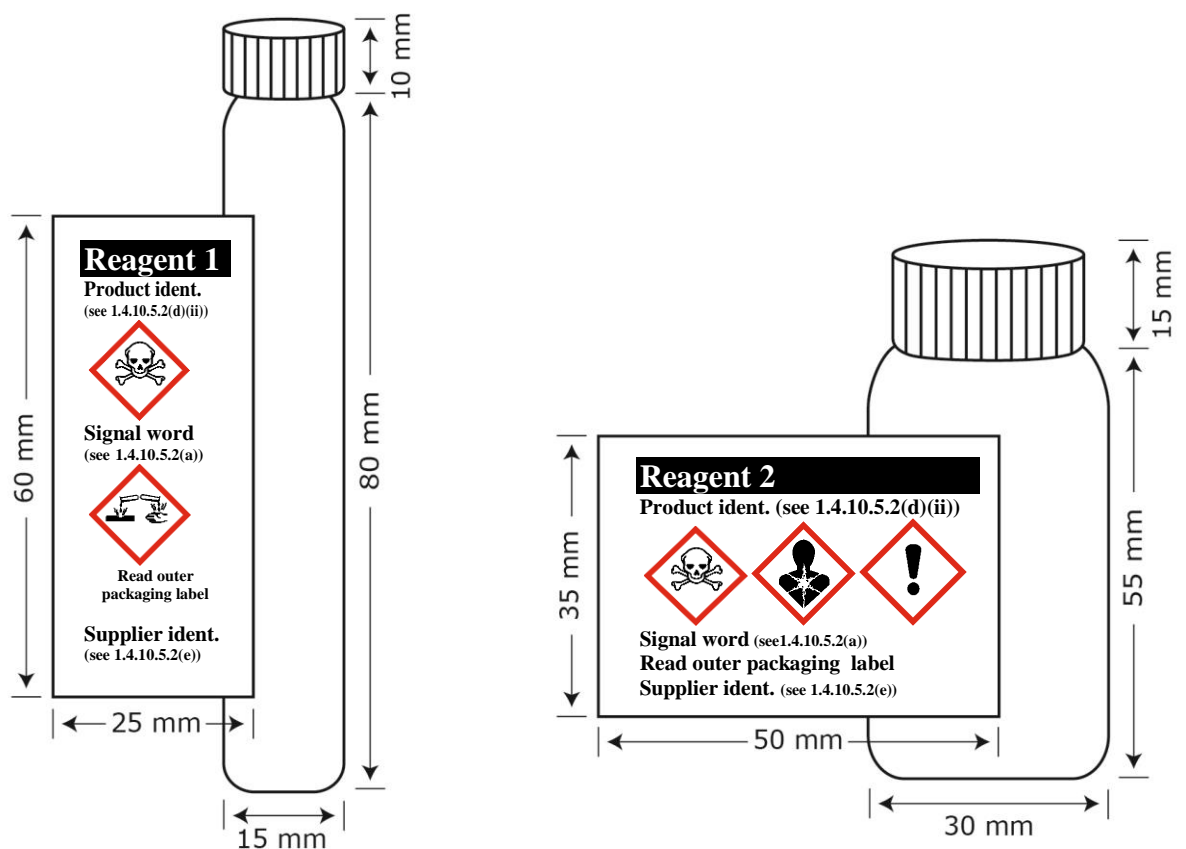

Outer kit label

All required GHS label elements of each hazardous substance or mixture appear on the outside packaging. To maintain readability, it might, in individual cases, for example if a lot of precautionary statements are required, be necessary to locate the precautionary statements separately. They should be displayed on a surface that is visible under normal conditions of use. Redundant precautionary statements need, when clearly recognizable, only appear once.

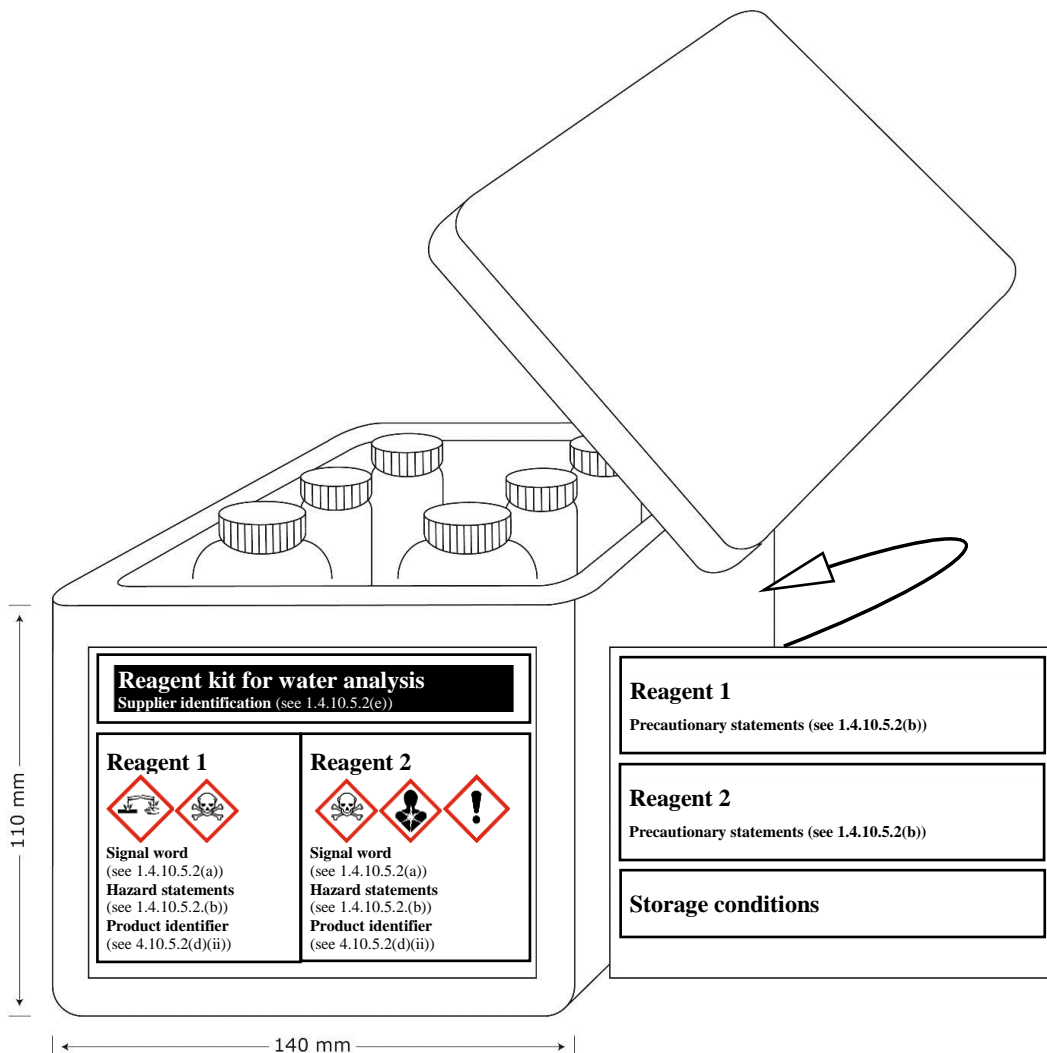

Example 11:

If it is not possible to affix all appropriate labelling elements for each hazardous substance or mixture directly on the outer packaging label (due to technical reasons such as the size and shape) additional options, always carried out with maximum care and with regard to the nature of the set or kit, can be chosen, one option might be to include fixed slip sheets.

Sample kit: Used for marketing purposes and consisting of 156 different substances or mixtures in individual 10 ml bottles presented in an outer packaging. The inner bottles are stored in the outer packaging throughout the lifecycle of the sample kit. Customers may select individual bottles and remove them from the box to check clarity, colour or odour and then replace it into the open slot within the outer box.

Each sample kit is made up of a plastic outer box containing 156 bottles. Depending upon the contents of each bottle, some or all of the 156 different substances or mixtures may be classified as hazardous.

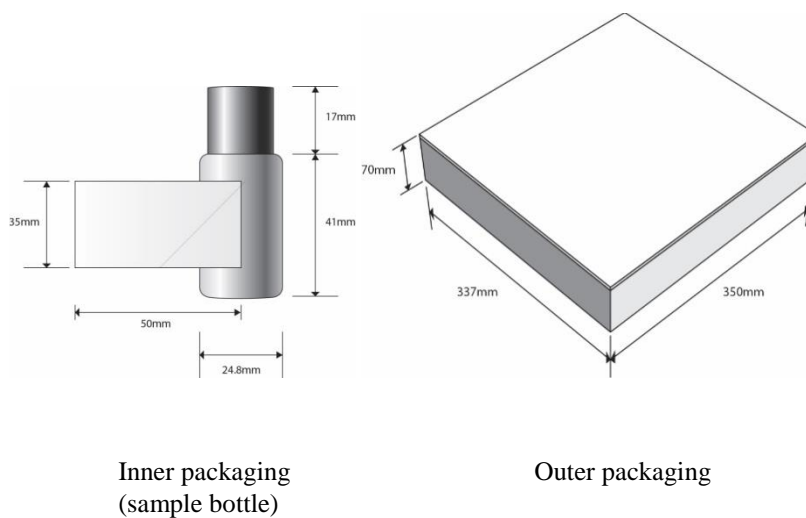
**Inner kit-label**

Each inner packaging label contains the following minimum required information:

- supplier information
- product identifier
- pictogram
- “Read full labelling information”



Full label information

Attached to the inside of the kit is the full GHS label information for each individual inner packaging. The individual product identifiers align with the product identifier on the inner packaging label. The content of the full label information is as shown below.

Product identifier (see 1.4.10.5.2 (d) (ii))	Pictogram(s) (see 1.4.10.4)	Signal word (see 1.4.10.5.2 (a))	Hazard statement(s) (see 1.4.10.5.2 (b))	Precautionary statement(s) (see 1.4.10.5.2 (c))	Supplemental information (see 1.4.10.5.4.2)
---	--------------------------------	-------------------------------------	---	--	--

Although the contents of each inner packaging may not be classified as hazardous, and thus would not need to be identified, it may be identified with a statement such as “Not classified” so as to eliminate confusion on the part of the user if the contents of an inner packaging is omitted from the full label information.

As shown to the right, full label information regarding each inner packaging is contained within the outer packaging.

The sheets of full label information are permanently connected to the inside of the combination packaging using a secure method of attachment (e.g. fold out label adhered to box tie on tag as shown)

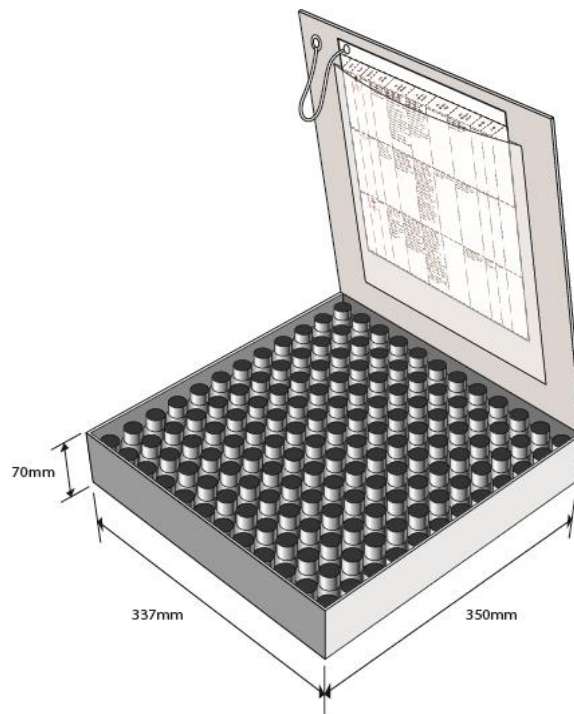

Outer kit label

The outer box, given the limited area for labelling, will display:

- kit identifier (name of kit)
- supplier identification
- storage conditions for the kit as a whole
- pictograms of each single hazardous substance or mixture without duplication
- signal word

