



## Economic and Social Council

Distr.: General  
22 December 2015

Original: English

---

### Economic Commission for Europe

#### Inland Transport Committee

#### World Forum for Harmonization of Vehicle Regulations

##### 168<sup>th</sup> session

Geneva, 8-11 March 2016

Item 4.13.1 of the provisional agenda

**1958 Agreement – Consideration of proposals for new Regulations  
submitted by the Working Parties subsidiary to the World Forum**

### **Proposal for a new Regulation concerning the approval of quiet road transport vehicles (QRTV)**

#### **Submitted by the Working Party on Noise\***

The text reproduced below was adopted by the Working Party on Noise (GRB) at its sixty-second session (ECE/TRANS/WP.29/GRB/60, para. 22. It is based on ECE/TRANS/WP.29/GRB/2015/9. It is submitted to the World Forum for Harmonization of Vehicle Regulations (WP.29) and to the Administrative Committee AC.1 for consideration at their March 2016 sessions.

---

\* In accordance with the programme of work of the Inland Transport Committee for 2014–2018 (ECE/TRANS/240, para. 105 and ECE/TRANS/2014/26, programme activity 02.4), the World Forum will develop, harmonize and update Regulations in order to enhance the performance of vehicles. The present document is submitted in conformity with that mandate.

Adopt a new Regulation No. XX to read:

**"Uniform provisions concerning the approval of Quiet Road Transport Vehicles with regard to their reduced audibility**

**Contents**

	<i>Page</i>
1. Scope.....	3
2. Definitions .....	3
3. Application for approval .....	5
4. Markings .....	5
5. Approval .....	6
6. Specifications .....	6
7. Modification and extension of approval of a vehicle type .....	9
8. Conformity of production.....	10
9. Penalties for non-conformity of production .....	10
10. Production definitively discontinued.....	10
11. Transitional provisions.....	10
12. Names and addresses of Technical Services responsible for conducting approval tests and of Type Approval Authorities.....	10
<b>Annexes</b>	
1. Communication.....	11
Addendum to the Communication Form (Technical Information document) .....	13
2. Arrangements of the approval mark.....	17
3. Methods and instruments for measuring the sound made by motor vehicles .....	18
Appendix: Figures and Flowcharts.....	30

## 1. Scope

This Regulation applies to electrified vehicles of categories M and N which can travel in the normal mode, in reverse or at least one forward drive gear, without an internal combustion engine operating<sup>1</sup> in respect to their audibility.

## 2. Definitions

For the purpose of this Regulation,

- 2.1. "*Approval of a vehicle*" means the approval of a vehicle type with regard to sound;
- 2.2. "*Acoustic Vehicle Alerting System*" (AVAS) means a component or set of components installed in vehicles with the primary purpose to fulfil the requirements of this Regulation;
- 2.3. "*Vehicle type*" means a category of motor vehicles which does not differ essentially in such respects as:
  - 2.3.1. The shape and the materials of the bodywork of the vehicle which affect the sound level emitted.
  - 2.3.2. The principle of the drivetrain (from the batteries to the wheels). Notwithstanding the provisions of 2.3.2. vehicles which differ with respect to overall gear ratios, battery type or the fitment of a range extender may be considered vehicles of the same type;
  - 2.3.3. If applicable, the number and type(s) of sound emitting devices (hardware) of AVAS fitted on the vehicle;
  - 2.3.4. If applicable, the position of the AVAS on the vehicle.
- 2.4. "*Frequency Shift*" means the variation of the frequency content of the AVAS sound as a function of the vehicle speed.
- 2.5. "*Electrified vehicle*" means a vehicle with a powertrain containing at least one electric motor or electric motor-generator.
  - 2.5.1. "*Pure Electric Vehicle*" (PEV) means a motor vehicle with an electric motor as its sole mean of propulsion.
  - 2.5.2. "*Hybrid Electric Vehicle*" (HEV) means a vehicle with a powertrain containing at least one electric motor or electric motor generator and at least one internal combustion engine as propulsion energy converters.
  - 2.5.3. "*Fuel Cell vehicle*" (FCV) means a vehicle with a fuel cell and an electric machine as propulsion energy converters.

---

<sup>1</sup> At this stage, only acoustic measures shall be developed in order to overcome the concern of reduced audible signals from electrified vehicles. After finalisation, the appropriate GR shall be assigned with the enhancement of the Regulation in order to develop alternative, non-acoustic measures, taking into account active safety systems such as, but not limited to, pedestrian detection systems. To provide for environmental protection, this Regulation specifies also maximum limits.

- 2.5.4. "Fuel Cell Hybrid Vehicle" (FCHV) means a vehicle with at least one fuel storage system and at least one Rechargeable Electric Energy Storage System (REESS) as propulsion energy storage system.
- 2.6. "Mass in running order" means the mass of the vehicle, with its fuel tank(s) filled to at least 90% of its or their capacity/ies, including the mass of the driver (75 kg), of the fuel and liquids, fitted with the standard equipment in accordance with the manufacturer's specifications and, when they are fitted, the mass of the bodywork, the cabin, the coupling and the spare wheel(s) as well as the tools.
- 2.7. "Pause function" means a mechanism to halt temporarily the operation of an AVAS.
- 2.8. "Front plane of the vehicle" means a vertical plane tangent to the leading edge of the vehicle.
- 2.9. "Rear plane of the vehicle" means a vertical plane tangent to the trailing edge of the vehicle.
- 2.10. Symbols and abbreviated terms and the paragraph in which they are first used.

Table 1  
Symbols and Abbreviations

Symbol	Unit	Paragraph	Explanation
ICE	-	6.2.	Internal Combustion Engine
AA'	-	Annex 3 para.3	Line perpendicular to vehicle travel which indicates the beginning of the zone to record sound pressure level during test
BB'	-	Annex 3 para.3	Line perpendicular to vehicle travel which indicates end of the zone to record sound pressure level during test
PP'	-	Annex 3 para.3	Line perpendicular to vehicle travel which indicates location of microphones
CC'	-	Annex 3 para.3	Centreline of vehicle travel
$v_{test}$	km/h	Annex 3 para.3	Target vehicle test velocity
j	-	Annex 3 para.3	Index for single test run within standstill or constant speed test conditions
$L_{reverse}$	dB(A)	Annex 3 para.3	Vehicle A-weighted sound pressure level for reversing test
$L_{crs,10}$	dB(A)	Annex 3 para.3	Vehicle A-weighted sound pressure level for constant speed test at 10 km/h.
$L_{crs,20}$	dB(A)	Annex 3 para.3	Vehicle A-weighted sound pressure level for constant speed test at 20 km/h.
$L_{corr}$	dB(A)	Annex 3 para.2.3.2	Background noise correction
$L_{test,j}$	dB(A)	Annex 3 para.2.3.2	A-weighted sound pressure level result of $j^{th}$ test run
$L_{testcorr,j}$	dB(A)	Annex 3 para.2.3.2	A-weighted sound pressure level result of $j^{th}$ test run corrected for background noise
$L_{bgn}$	dB(A)	Annex 3 para.2.3.1	Background A-weighted sound pressure level.

<i>Symbol</i>	<i>Unit</i>	<i>Paragraph</i>	<i>Explanation</i>
$\Delta L_{\text{bgn, p-p}}$	dB(A)	Annex 3 para.2.3.2	Range of maximum to minimum value of the representative background noise A-weighted sound pressure level over a defined time period.
$\Delta L$	dB(A)	Annex 3 para.2.3.2	A-weighted sound pressure level of $j^{\text{th}}$ test result minus the A-weighted background noise level ( $\Delta L = L_{\text{test},j} - L_{\text{bgn}}$ )
$v_{\text{ref}}$	km/h	Annex 3 para.4	Reference vehicle velocity used for calculating frequency shift percentage.
$f_{j, \text{speed}}$	Hz	Annex 3 para.4	Single frequency component at a given vehicle speed per sample segment, e.g. $f_{1,5}$
$f_{\text{ref}}$	Hz	Annex 3 para.4	Single frequency component at reference vehicle speed
$f_{\text{speed}}$	Hz	Annex 3 para.4	Single frequency component at a given vehicle speed, e.g. $f_5$
$l_{\text{veh}}$	m	Annex 3, Appendix	Length of vehicle

### 3. Application for approval

- 3.1. The application for approval of a vehicle type with regard to reduced audibility shall be submitted by its manufacturer or by a duly accredited representative.
- 3.2. It shall be accompanied by the undermentioned documents and the following particulars:
  - 3.2.1. A description of the vehicle type with regard to the items mentioned in paragraph 2.3. above;
  - 3.2.2. A description of the engine(s) as mentioned in Annex 1, Addendum;
  - 3.2.3. If applicable, a list of the components constituting the AVAS;
  - 3.2.4. If applicable, a drawing of the assembled AVAS and an indication of its position on the vehicle.
- 3.3. In the case of paragraph 2.3., the single vehicle, representative of the type in question, will be selected by the Technical Service conducting approval tests, in accordance with the vehicle manufacturer.
- 3.4. The Type Approval Authority shall verify the existence of satisfactory arrangements for ensuring effective control of the conformity of production before type approval is granted.

### 4. Markings

- 4.1. The components of the AVAS (if applicable) shall bear:
  - 4.1.1. The trade name or mark of the manufacturer(s) of the AVAS components;
  - 4.1.2. A designated identification number(s).
- 4.2. These markings shall be clearly legible and be indelible.

## **5. Approval**

- 5.1. Type approval shall only be granted if the vehicle type meets the requirements of paragraphs 6 and 7 below.
- 5.2. An approval number shall be assigned to each type approved. Its first two digits (at present 00 corresponding to the 00 series of amendments) shall indicate the series of amendments incorporating the most recent major technical amendments made to the Regulation at the time of issue of the approval. The same Contracting Party shall not assign the same number to another vehicle type.
- 5.3. Notice of approval or of extension or of refusal or withdrawal of approval or of production definitively discontinued of a vehicle type pursuant to this Regulation shall be communicated to the Parties to the Agreement applying this Regulation by means of a form conforming to the model in Annex 1 to this Regulation.
- 5.4. There shall be affixed to every vehicle conforming to a vehicle type approved under this Regulation, conspicuously and in a readily accessible place specified on the approval form, an international approval mark consisting of:
  - 5.4.1. A circle surrounding the letter "E" followed by the distinguishing number of the country which has granted approval;
  - 5.4.2. The number of this Regulation, followed by the letter "R", a dash and the approval number to the right of the circle prescribed in paragraph 5.4.1.
- 5.5. If the vehicle conforms to a vehicle type approved, under one or more other Regulations annexed to the Agreement, in the country which has granted approval under this Regulation, the symbol prescribed in paragraph 5.4.1. need not be repeated. In such a case the regulation and approval numbers and the additional symbols of all the Regulations under which approval has been granted in the country which has granted approval under this Regulation shall be placed in vertical columns to the right of the symbol prescribed in paragraph 5.4.1.
- 5.6. The approval mark shall be clearly legible and indelible.
- 5.7. The approval mark shall be placed close to or on the vehicle data plate affixed by the manufacturer.
- 5.8. Annex 2 to this Regulation gives examples of arrangements of the approval mark.

## **6. Specifications**

- 6.1. General specifications

For the purpose of this Regulation, the vehicle shall fulfil the following requirements:
- 6.2. Acoustics characteristics

The sound emitted by the vehicle type submitted for approval shall be measured by the methods described in Annex 3 to this Regulation. The speed range for operation is the range of greater than 0 km/h up to and inclusive 20 km/h.

If the vehicle that is not equipped with an AVAS fulfils the overall levels as specified in table 2 below with a margin of +3 dB(A), the specification for one-third octave bands and the frequency shift do not apply.

- 6.2.1. Constant speed tests
- 6.2.1.1. The test speeds for approval are 10 km/h and 20 km/h.
- 6.2.1.2. When tested under the conditions of Annex 3 paragraph 3.3.2, the vehicle shall emit a sound
- (a) That has a minimum overall sound pressure level for the applicable test speed according to Table 2 of paragraph 6.2.8.;
  - (b) That has at least two of the one-third octave bands according to Table 2 of paragraph 6.2.8. At least one of these bands shall be below or within the 1,600 Hz one-third octave band;
  - (c) With minimum sound pressure levels in the chosen bands for the applicable test speed according to Table 2 of paragraph 6.2.8., column 3 or column 4.
- 6.2.1.3. If after a vehicle is tested in accordance with Annex 3 paragraph 3.3.2., for ten consecutive times within a series of measurements without recording a valid measurement because the vehicle's internal combustion engine (ICE) remains active or restarts and interferes with the measurements, the vehicle is exempted from this particular test.
- 6.2.2. Reversing test
- 6.2.2.1. When tested under the conditions of Annex 3 paragraph 3.3.3. the vehicle must emit a sound that has a minimum overall sound pressure level according to Table 2 of paragraph 6.2.8., column 5.
- 6.2.2.2. If after a vehicle is tested in accordance with Annex 3, paragraph 3.3.3., for ten consecutive times within a series of measurements without recording a valid measurement because the vehicle's ICE remains active or restarts and interferes with the measurements, the vehicle is exempted from this particular test.
- 6.2.3. Frequency shift to signify acceleration and deceleration
- 6.2.3.1. The intention of frequency shift is to acoustically inform road users about the change in vehicle speed.
- 6.2.3.2. When tested under the conditions of Annex 3 paragraph 4, at least one tone within the frequency range as specified in paragraph 6.2.8. emitted by the vehicle shall vary proportionally with speed within each individual gear ratio by an average of at least 0.8 % per 1 km/h in the speed range from 5 km/h to 20 km/h inclusive when driving in forward direction. In case more than one frequency is shifted, only one frequency shift needs to fulfil the requirements.
- 6.2.4. Stationary sound
- The vehicle may emit a sound when stationary.
- 6.2.5. Driver selectable sounds
- The vehicle manufacturer may define alternative sounds which can be selected by the driver; each of these sounds shall be in compliance and approved with the provisions in paragraphs 6.2.1. to 6.2.3.

- 6.2.6. Pause function
- The manufacturer may install a function for temporary deactivation of the AVAS. Any other deactivation function, which does not satisfy the specification below, is prohibited.
- 6.2.6.1. The function shall be located so that it is operable by the driver in a normal seating position.
- 6.2.6.2. In the case when the pause function is activated, the suspension of AVAS has to be clearly indicated to the driver.
- 6.2.6.3. The AVAS shall be reactivated when the vehicle is started upon each vehicle turn-off.
- 6.2.6.4. Owner's manual information
- If a pause function is installed, the manufacturer shall provide the owner with information (e.g. in the owner's manual) on its effect:
- "The pause function of the Acoustic Vehicle Alerting System (AVAS) shall not be used unless for an obvious lack of necessity to emit sound for alert in the surrounding area and that it is certain that there are no pedestrians within the short distance."
- 6.2.7. Specifications on maximum sound level for AVAS
- When tested under the conditions of Annex 3 paragraph 3.3.2, a vehicle which is equipped with an AVAS, shall not emit an overall sound level of more than 75 dB(A), if driving in forward direction.<sup>2</sup>
- 6.2.8. Minimum sound levels
- The sound level measured in accordance with the provisions of Annex 3 to this Regulation, mathematically rounded to the nearest integer value, shall have at least the followings values:

---

<sup>2</sup> The maximum overall sound pressure level of 75 dB(A) measured at a distance of 2 m is corresponding to the overall sound pressure level of 66 dB(A) measured at a distance of 7,5 m. The limit value of 66 dB(A) at a distance of 7,5 m is the lowest permitted maximum value in Regulations established under the 1958 Agreement.



Table 2  
**Minimum Sound Level Requirements in dB(A)**

Frequency in Hz		Constant Speed Test paragraph 3.3.2. (10 km/h)	Constant Speed Test paragraph 3.3.2. (20 km/h)	Reversing Test paragraph 3.3.3.
Column 1	Column 2	Column 3	Column 4	Column 5
Overall		50	56	47
1/3 <sup>rd</sup> Octave Bands	160	45	50	X
	200	44	49	
	250	43	48	
	315	44	49	
	400	45	50	
	500	45	50	
	630	46	51	
	800	46	51	
	1,000	46	51	
	1,250	46	51	
	1,600	44	49	
	2,000	42	47	
	2,500	39	44	
	3,150	36	41	
4,000	34	39		
5,000	31	36		

## 7. Modification and extension of approval of a vehicle type

- 7.1. Every modification of the vehicle type shall be notified to the Type Approval Authority which approved the vehicle type. The Type Approval Authority may then either:
- 7.1.1. consider that the modifications made are unlikely to have an appreciable adverse effect and that in any case the vehicle still complies with the requirements, or
- 7.1.2. require a further test report from the Technical Service responsible for conducting the tests.
- 7.2. Confirmation or refusal of approval, specifying the alterations shall be communicated by the procedure specified in paragraph 5.3. above to the Parties to the Agreement applying this Regulation.
- 7.3. The Type Approval Authority issuing the extension of approval shall assign a series number for such an extension and inform thereof the other Parties to the 1958 Agreement applying this Regulation by means of a communication form conforming to the model in Annex 1 to this Regulation.

## **8. Conformity of production**

The conformity of production procedures shall comply with those set out in the Agreement, Appendix 2 (E/ECE/324-E/ECE/TRANS/505/Rev.2) with the following requirements:

- 8.1. Vehicles approved according to this Regulation shall be manufactured so as to conform to the type approved and satisfy the requirements set forth in paragraph 6.2. above.
- 8.2. The authority which has granted type approval may at any time verify the conformity control methods applied in each production facility. The normal frequency of these verifications shall be one every two years.

## **9. Penalties for non-conformity of production**

- 9.1. The approval granted in respect of a vehicle type pursuant to this Regulation may be withdrawn if the requirements set forth above are not met.
- 9.2. If a Contracting Party to the Agreement applying this Regulation withdraws an approval it has previously granted, it shall forthwith so notify the other Contracting Parties applying this Regulation, by means of a communication form conforming to the model in Annex 1 to this Regulation.

## **10. Production definitively discontinued**

If the holder of the approval completely ceases to manufacture a vehicle type approved in accordance with this Regulation, he shall so inform the authority which granted the approval. Upon receiving the relevant communication that authority shall inform thereof the other Parties to the 1958 Agreement applying this Regulation by means of a communication form conforming to the model in Annex 1 to this Regulation.

## **11. Transitional provisions**

Until 30 June 2019 ISO 10844:1994 may be applied as an alternative to ISO 10844:2014 to check compliance of the test track as described in Annex 3, paragraph 2.1.2. of this Regulation.

## **12. Names and addresses of Technical Services responsible for conducting approval tests and of Type Approval Authorities**

The Contracting Parties to the 1958 Agreement applying this Regulation shall communicate to the United Nations Secretariat the names and addresses of the Technical Services responsible for conducting approval tests and of the Type Approval Authorities which grant approval and to which forms certifying approval or extension or refusal or withdrawal of approval, issued in other countries, are to be sent.

## Annex 1

### Communication

(maximum format: A4 (210 x 297 mm))

issued by: Name of administration:



.....  
 .....  
 .....

- concerning:<sup>2</sup>
- Approval granted
  - Approval extended
  - Approval refused
  - Approval withdrawn
  - Production definitively discontinued

of a vehicle type with regard to its sound emission pursuant to Regulation No. XX

Approval No. .... Extension No. ....

#### SECTION I

- 0.1. Make (trade name of manufacturer): .....
- 0.2. Vehicle Type: .....
- 0.3. Means of identification of type if marked on the vehicle:<sup>3</sup> .....
- 0.3.1. Location of that marking: .....
- 0.4. Category of vehicle:<sup>4</sup> .....
- 0.5. Propulsion principle (PEV/HEV/FCV/FCHV): .....
- 0.6. Company name and address of manufacturer: .....
- 0.7. Names and Address(es) of assembly plant(s): .....
- 0.8. Name and address of the manufacturer's representative (if any): .....

<sup>1</sup> Distinguishing number of the country which has granted/extended/refused/withdrawn approval (see approval provisions in the Regulation).

<sup>2</sup> Delete what does not apply.

<sup>3</sup> If the means of identification of type contains characters not relevant to describe the vehicle, types covered by the type-approval certificate such characters shall be represented in the documentation by the symbol: '?' (e.g. ABC??123??).

<sup>4</sup> As defined in R.E.3.

SECTION II

1. Additional information (where applicable): See Addendum
2. Technical service responsible for carrying out the tests: .....
3. Date of test report: .....
4. Number of test report: .....
5. Remarks (if any): See Addendum
6. Place: .....
7. Date: .....
8. Signature: .....
9. Reasons for Extensions  
Attachments:  
Information package  
Test report(s)

## Addendum to the communication form No ...

### Technical Information

- 0. General
  - 0.1. Make (trade name of manufacturer):
  - 0.2. Means of identification of type, if marked on the vehicle:<sup>5</sup>
    - 0.2.1. Location of that marking:
  - 0.3. Category of vehicle:<sup>6</sup>
  - 0.4. Company name and address of manufacturer:
  - 0.5. Name and address of the manufacturer's representative (if any):
  - 0.6. Name(s) and Address(es) of assembly plant(s):
- 1. Additional information
  - 1.1. Power plant
    - 1.1.1. Propulsion principle (PEV/HEV/FCV/FCHV) :
    - 1.1.2. Manufacturer of the engine(s):
    - 1.1.3. Manufacturer's engine code(s):
  - 1.2. Description of AVAS (if applicable): .....
    - 1.2.1. Pause switch (yes/no)
    - 1.2.2. Sound at Stationary (yes/no)
    - 1.2.3. No. of driver selectable sounds (1/2/3/...)
- 2. Test results
  - 2.1. Sound level of moving vehicle: ..... dB(A) at 10 km/h
  - 2.2. Sound level of moving vehicle: ..... dB(A) at 20 km/h
  - 2.3. Sound level of moving vehicle: ..... dB(A) in reversing
  - 2.4. Frequency shift: ..... % /km/h
- 3. Remarks

<sup>5</sup> If the means of identification of type contains characters not relevant to describe the vehicle, types covered by the type-approval certificate such characters shall be represented in the documentation by the symbol: '?' (e.g. ABC??123??).

<sup>6</sup> As defined in R.E.3.

## Technical Information Document<sup>7</sup>

0. General
  - 0.1. Make (trade name of manufacturer): .....
  - 0.2. Type
  - 0.3. Means of identification of type, if marked on the vehicle:<sup>8</sup>
    - 0.3.1. Location of that marking: .....
  - 0.4. Category of vehicle:<sup>9</sup> .....
  - 0.5. Company name and address of manufacturer: .....
  - 0.6. Name and address of the manufacturer's representative (if any): .....
  - 0.8. Name(s) and Address(es) of assembly plant(s): .....
1. General construction characteristics of the vehicle
  - 1.1. Photographs and/or drawings of a representative vehicle: .....
  - 1.3. Number of axles and wheels:<sup>10</sup> .....
  - 1.3.3. Powered axles (number, position, interconnection): .....
  - 1.6. Position and arrangement of the engine(s): .....
2. Masses and dimensions<sup>11</sup> (in kg and mm) (Refer to drawing where applicable): .....
- 2.4. Range of vehicle dimensions (overall): .....
- 2.4.1 For chassis without bodywork: .....
- 2.4.1.1. Length: .....
- 2.4.1.2. Width: .....
- 2.4.2. For chassis with bodywork
  - 2.4.2.1. Length: .....
  - 2.4.2.2. Width: .....

<sup>7</sup> Manufactures may automatically create this Technical Information Document by selecting the relevant items from the commonly agreed matrix. These items will appear in the Technical Information Document under the same numbers as in the matrix. Thus, the numbering of items in the Technical Information Document may not necessarily be continuous.

<sup>8</sup> If the means of identification of type contains characters not relevant to describe the vehicle, types covered by the type-approval certificate such characters shall be represented in the documentation by the symbol: '?' (e.g. ABC??123??).

<sup>9</sup> As defined in R.E.3.

<sup>10</sup> Only for the purpose of defining "off-road vehicles".

<sup>11</sup> (a) Standard ISO 612: 1978 — Road vehicles — Dimensions of motor vehicles and towed vehicles - terms and definitions.

(b) Where there is one version with a normal cab and another with a sleeper cab, both sets of masses and dimensions are to be stated.

(c) Optional equipment that affects the dimensions of the vehicle shall be specified.

- 
- 2.6. Mass in running order
    - minimum and maximum: .....
  - 3. Power plant<sup>12</sup>
    - 3.1. Manufacturer of the engine(s):
      - 3.1.1. Manufacturer's engine code(s) (as marked on the engine(s), or other means of identification): .....
    - 3.3. Electric motor
      - 3.3.1. Type of the electric motor (winding, excitation):
    - 3.4. Engine or motor combination:
      - 3.4.4. Electric motor (describe each type of electric motor separately)
        - 3.4.4.1. Make: .....
        - 3.4.4.2. Type: .....
        - 3.4.4.3. Maximum power: .....kW
  - 6. Suspension
    - 6.6. Tyre size
      - 6.6.2. Upper and lower limits of rolling radii
        - 6.6.2.1. Axle 1: .....
        - 6.6.2.2. Axle 2: .....
        - 6.6.2.3. Axle 3: .....
        - 6.6.2.4. Axle 4: .....
    - etc.
  - 9. Bodywork
    - 9.1. Type of bodywork:
    - 9.2. Materials used and methods of construction:
  - 12. Miscellaneous
    - 12.5. Details of materials and components influencing the sound emission of the vehicle (if not covered by other items): .....
  - 17. AVAS (if applicable)
    - 17.1. Type of the AVAS (loudspeaker ...): .....
    - 17.1.1. Make: .....
    - 17.1.2. Type: .....
    - 17.1.3. Geometrical characteristics (internal length and diameter)
    - 17.2. The following documents are annexed to this communication:

---

<sup>12</sup> In the case of a vehicle that can run either on petrol, diesel, etc., or also in combination with another fuel, items shall be repeated. In the case of non-conventional engines and systems, particulars equivalent to those referred here shall be supplied by the manufacturer.

- 17.2.1. drawings of the mountings of the sound emitting device(s),
- 17.2.2. ... drawings and diagrams giving the mounting positions and characteristics of the parts of the structure on which the devices are fitted.
- 17.2.3. ... over-all views of the front of the vehicle and of the compartment in which the device is situated and description of the component materials.

Signed: .....

Position in company: .....

Date: .....



## Annex 2

### Arrangements of the approval mark

Model A  
(See paragraph 5.4. of this Regulation)



$a = 8 \text{ mm min.}$

The above approval mark affixed to a vehicle shows that the vehicle type concerned has, with regard to its audibility, been approved in the Netherlands (E 4) pursuant to Regulation No. XXX under approval No. 002439.

The first two digits of the approval number indicate that Regulation No. XX already included the 00 series of amendments when the approval was granted.

Model B  
(See paragraph 5.5. of this Regulation)

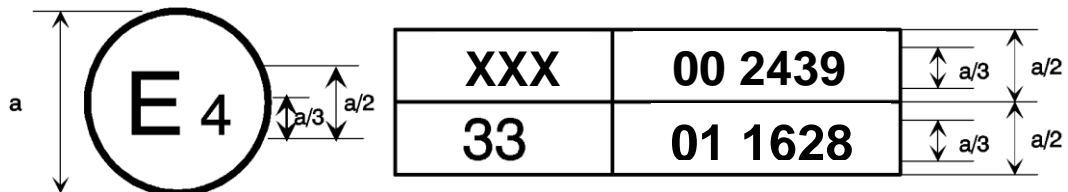

$a = 8 \text{ mm min.}$

The above approval mark affixed to a vehicle shows that the vehicle type concerned has been approved in the Netherlands (E 4) pursuant to Regulations Nos. XXX and 33.<sup>1</sup> The approval numbers indicate that, at the dates when the respective approvals were granted, Regulation No. XXX included the 00 series of amendments while Regulation No. 33 included the 01 series of amendments.

<sup>1</sup> The latter number is given as an example only.

## Annex 3

### Methods and instruments for measuring the sound made by motor vehicles

#### 1. Instrumentation

##### 1.1. Instruments for acoustic measurement

##### 1.1.1. General

The apparatus used for measuring the sound pressure level shall be a sound level meter or equivalent measurement system meeting the requirements of Class 1 instruments (inclusive of the recommended windscreen, if used). These requirements are described in IEC 61672-1-2013.

The entire measurement system shall be checked by means of a sound calibrator that fulfils the requirements of Class 1 sound calibrators in accordance with IEC 60942-2003.

Measurements shall be carried out using the time weighting "F" of the acoustic measurement instrument and the "A" frequency weighting also described in IEC 61672-1-2013. When using a system that includes a periodic monitoring of the A-weighted sound pressure level, a reading should be made at a time interval not greater than 30 ms.

When measurements are carried out for one-third octaves, the instrumentation shall meet all requirements of IEC 61260-1-2014, class 1. When measurements are carried out for frequency shift, the digital sound recording system shall have at least a 16 bit quantization. The sampling rate and the dynamic range shall be appropriate to the signal of interest.

The instruments shall be maintained and calibrated in accordance with the instructions of the instrument manufacturer.

##### 1.1.2. Calibration

At the beginning and at the end of every measurement session, the entire acoustic measurement system shall be checked by means of a sound calibrator as described in paragraph 1.1.1. Without any further adjustment, the difference between the readings shall be less than or equal to 0,5 dB(A). If this value is exceeded, the results of the measurements obtained after the previous satisfactory check shall be discarded.

##### 1.1.3. Compliance with requirements

Compliance of the sound calibrator with the requirements of IEC 60942-2003 shall be verified once a year. Compliance of the instrumentation system with the requirements of IEC 61672-3-2013 shall be verified at least every 2 years. All compliance testing shall be conducted by a laboratory which is authorized to perform calibrations traceable to the appropriate standards.

##### 1.2. Instrumentation for speed measurements

The road speed of the vehicle shall be measured with instruments meeting specification limits of at least  $\pm 0,5$  km/h when using continuous measuring devices.

If testing uses independent measurements of speed, this instrumentation shall meet specification limits of at least  $\pm 0,2$  km/h.

1.3. Meteorological instrumentation

The meteorological instrumentation used to monitor the environmental conditions during the test shall meet the specifications of:

- (a)  $\pm 1$  °C or less for a temperature measuring device;
- (b)  $\pm 1,0$  m/s for a wind speed-measuring device;
- (c)  $\pm 5$  hPa for a barometric pressure measuring device;
- (d)  $\pm 5$  % for a relative humidity measuring device.

2. Acoustic environment, meteorological conditions, and background noise

2.1. Test site

2.1.1. General

The specifications for the test site provide the necessary acoustic environment to carry out the vehicle tests documented in this regulation. Outdoor and indoor test environments that meet the specifications of this regulation provide equivalent acoustic environments and produce results that are equally valid.

2.1.2. Outdoor testing

The test site shall be substantially level. The test track construction and surface shall meet the requirements of ISO 10844:2014.

Within a radius of 50 m around the centre of the track, the space shall be free of large reflecting objects such as fences, rocks, bridges or buildings. The test track and the surface of the site shall be dry and free from absorbing materials such as powdery snow, or loose debris.

In the vicinity of the microphones, there shall be no obstacle that could influence the acoustic field and no person shall remain between the microphone and the noise source. The meter observer shall be positioned so as not to influence the meter reading. Microphones shall be located as specified in Figures 1.

2.1.3. Indoor hemi anechoic or anechoic testing

This paragraph specifies conditions applicable when testing a vehicle, either operating as it would on the road with all systems operational, or operating in a mode where only the AVAS is operational.

The test facility shall meet requirements of ISO 26101:2012 with the following qualification criteria and measurement requirements appropriate to this test method.

Space to be deemed hemi-anechoic shall be defined as shown in Figure 3.

For qualifying the hemi acoustic space, the following evaluation shall be conducted:

- (a) Sound source location shall be place on the floor in middle of the space deemed to be anechoic;
- (b) Sound source shall provide a broadband input for measurement;

- (c) Evaluation shall be conducted in one-third-octave bands;
- (d) Microphone locations for evaluation shall be on a line from the source location to each position of microphones used for measurement in this Regulation as shown in Figure 3. This is commonly referred to as the microphone transverse;
- (e) A minimum of 10 points shall be used for evaluation on the microphone transverse line;
- (f) The one third octave bands used to establish hemi-anechoic qualification shall be defined to cover the spectral range of interest.

The test facility shall have a cut-off frequency, as defined in ISO 26101:2012, lower than the lowest frequency of interest. The lowest frequency of interest is the frequency below which there is no signal content relevant to the measurement of sound emission for the vehicle under test.

In the vicinity of the microphones, there shall be no obstacle that could influence the acoustic field and no person shall remain between the microphone and the noise source. The meter observer shall be positioned so as not to influence the meter reading. Microphones shall be located as specified in Figures 2.

## 2.2. Meteorological conditions

Metrological conditions are specified to provide a range of normal operating temperatures and to prevent abnormal readings due to extreme environmental conditions.

A value representative of temperature, relative humidity, and barometric pressure shall be recorded during the measurement interval.

The meteorological instrumentation shall deliver data representative for the test site and shall be positioned adjacent to the test area at a height representative of the height of the measuring microphone.

The measurements shall be made when the ambient air temperature is within the range from 5 °C to 40 °C.

The ambient temperature may of necessity be restricted to a narrower temperature range such that all key vehicle functionalities that can reduce vehicle noise emissions (e.g. start/stop, hybrid propulsion, battery propulsion, fuel-cell stack operation) are enabled according to manufacturer's specifications.

The tests shall not be carried out if the wind speed, including gusts, at microphone height exceeds 5 m/s, during the measurement interval.

## 2.3. Background noise

### 2.3.1. Measurement criteria for A-weighted sound pressure level

The background, or ambient noise, shall be measured for a duration of at least 10 seconds. A 10 second sample taken from these measurements shall be used to calculate the reported background noise, ensuring the 10 seconds sample selected is representative of the background noise in absence of any transient disturbance. The measurements shall be made with the same microphones and microphone locations used during the test.

When testing in an indoor facility, the noise emitted by the roller-bench,

chassis dynamometer or other test facility equipment, without the vehicle installed or present, inclusive of the noise caused by air handling of the facility and vehicle cooling, shall be reported as the background noise.

The recorded maximum A-weighted sound pressure level from both microphones during the 10 second sample shall be reported as the background noise,  $L_{bgn}$ , for both left and right microphones.

For each 10 second sample at each microphone, the maximum to minimum range of the background noise,  $\Delta L_{bgn, p-p}$ , shall be reported.

The one-third-octave frequency spectrum, corresponding to the reported maximum level of background noise in the microphone with the highest background level, shall be reported.

As an aid for measurement and reporting of background noises see flowchart in Figure 4 of the Appendix to this annex.

### 2.3.2. Vehicle A-weighted sound pressure level measurement correction criteria

Depending on the level and the range of maximum to minimum value of the representative background noise A-weighted sound pressure level over a defined time period, the measured  $j^{\text{th}}$  test result within a test condition,  $L_{\text{test},j}$ , shall be corrected according to the table below to obtain the background noise corrected level  $L_{\text{testcorr},j}$ . Except where noted,  $L_{\text{testcorr},j} = L_{\text{test},j} - L_{\text{corr}}$ .

Background noise corrections to measurements are only valid when the range of the maximum to minimum background noise A-weighted sound pressure levels are 2 dB(A) or less.

In all cases where the range of the maximum to minimum background noise is greater than 2 dB(A), the maximum level of the background noise shall be 10 dB(A) or greater below the level of the measurement. When the maximum to minimum range of background noise is greater than 2 dB(A) and the level of the background noise is less than 10 dB(A) below the measurement, no valid measurement is possible.

Table 3  
**Correction for level of background noise when measuring vehicle A-weighted sound pressure level**

<i>Correction for background noise</i>		
<i>Range of maximum to minimum value of the representative background noise A-weighted sound pressure level over a defined time period <math>\Delta L_{bgn, p-p}</math> in dB(A)</i>	<i>Sound pressure level of j-th test result minus background noise level <math>\Delta L = L_{\text{test},j} - L_{bgn}</math> in dB(A)</i>	<i>Correction in dB(A) <math>L_{\text{corr}}</math></i>
-	$\Delta L \geq 10$	no correction needed
$\leq 2$	$8 \leq \Delta L < 10$	0,5
	$6 \leq \Delta L < 8$	1,0
	$4.5 \leq \Delta L < 6$	1,5
	$3 \leq \Delta L < 4.5$	2,5
	$\Delta L < 3$	no valid measurement can be reported

If a sound peak obviously out of character with the general sound pressure level is observed, that measurement shall be discarded.

As an aid for measurement correction criteria see flowchart in Figure 4 of the appendix to this annex.

2.3.3. Background noise requirements when analysing in one-third-octave bands

When analysing one-third octaves according to this regulation, the level of background noise in each one-third octave of interest, analysed according to paragraph 2.3.1, shall be at least 6 dB(A) below the measurement of the vehicle or AVAS under test in each one-third-octave band of interest. The A-weighted sound pressure level of the background noise shall be at least 10 dB(A) below the measurement of the vehicle or AVAS under test.

Background compensation is not permitted for one-third octave band measurements.

As an aid for background noise requirements when analysing in one-third-octave bands see flowchart in Figure 6 of the Appendix to this annex.

3. Test procedures for vehicle sound level

3.1. Microphone positions

The distance from the microphone positions on the microphone line PP' to the perpendicular reference line CC' as specified in Figure 1 and 2 on the test track or in an indoor test facility shall be  $2,0 \text{ m} \pm 0,05 \text{ m}$ .

The microphones shall be located  $1,2 \text{ m} \pm 0,02 \text{ m}$  above the ground level. The reference direction for free field conditions as specified in IEC 61672-1:2013 shall be horizontal and directed perpendicularly towards the path of the vehicle line CC'.

3.2. Conditions of the vehicle

3.2.1. General conditions

The vehicle shall be representative of vehicles to be put on the market as specified by the manufacturer in agreement with the technical service to fulfil the requirements of this Regulation.

Measurements shall be made without any trailer, except in the case of non-separable vehicles.

In the case of HEVs/FCHVs, the test shall be carried out in the most energy efficient mode so to avoid the restart of the ICE, e.g. all audio-, entertainment-, communication- and navigation-systems shall be switched off.

Before the measurements are started, the vehicle shall be brought to its normal operating conditions.

3.2.2. Battery state of charge

If so equipped, propulsion batteries shall have a state-of-charge sufficiently high to enable all key functionalities according to the manufacturer's specifications. Propulsion batteries shall be within their component-temperature window to enable all key functionalities that could reduce vehicle sound emissions. Any other type of rechargeable energy storage system shall be ready to operate during the test.

### 3.2.3. Multi-mode operation

If the vehicle is equipped with multiple driver selectable operating modes, the mode which provides the lowest sound emission during the test conditions of paragraph 3.3 shall be selected.

When the vehicle provides multiple operating modes that are automatically selected by the vehicle, it is the responsibility of the manufacturer to determine the correct manner of testing to achieve the minimum sound emission.

In cases where it is not possible to determine the vehicle operating mode providing the lowest sound emission, all modes shall be tested and the mode giving the lowest test result shall be used to report the vehicle sound emission in accordance with this regulation.

### 3.2.4. Test mass of vehicle

Measurements shall be made on vehicles at mass in running order with an allowable tolerance of 15 %.

### 3.2.5. Tyre selection and condition

The tyres fitted to the vehicle during testing are selected by the vehicle manufacturer, and shall correspond to one of the tyre sizes and types designated for the vehicle by the vehicle manufacturer.

The tyres shall be inflated to the pressure recommended by the vehicle manufacturer for the test mass of the vehicle.

## 3.3. Operating conditions

### 3.3.1. General

For each operating condition, the vehicle can be tested either indoor or outdoor.

For constant speed and reversing tests the vehicle may be tested either in motion or in simulated operating condition. For simulated vehicle operation, signals shall be applied to the vehicle to simulate actual in-use operation.

If the vehicle is equipped with an internal combustion engine, it shall be turned off.

### 3.3.2. Constant speed tests

These tests are conducted with the vehicle in forward motion or with the vehicle speed simulated by an external signal to the AVAS with the vehicle in standstill condition.

#### 3.3.2.1. Constant speed tests in forward motion

For a vehicle tested in an outdoor facility, the path of the centreline of the vehicle shall follow line CC' as closely as possible with constant speed  $v_{\text{test}}$  throughout the entire test. The front plane of the vehicle shall pass from the line AA' at the start of the test and the rear plane of the vehicle shall pass from the line BB' at the end of the test, as shown in Figure 1a. Any trailer, which is not readily separable from the towing vehicle, shall be ignored when considering the crossing of the line BB'.

A vehicle tested in an indoor facility, shall be located with the front plane of the vehicle on the PP' line as shown in Figure 2a. The vehicle shall maintain a constant test speed,  $v_{\text{test}}$  for at least 5 seconds.

For constant speed test condition of 10 km/h, the test speed  $v_{\text{test}}$  shall be 10 km/h  $\pm$  2 km/h.

For constant speed test condition of 20 km/h, the test speed  $v_{\text{test}}$  shall be 20 km/h  $\pm$  1 km/h.

For automatic transmission vehicles, the gear selector shall be placed as specified by the manufacturer for normal driving.

For manual transmission vehicles, the gear selector shall be placed in the highest gear which can achieve the target vehicle speed with constant engine speed.

3.3.2.2. Constant speed tests simulated by an external signal to the AVAS with the vehicle in standstill condition

A vehicle tested in an indoor or outdoor facility, shall be located with the front plane of the vehicle on the PP' line as shown in Figure 2b. The vehicle shall maintain a constant simulated test speed,  $v_{\text{test}}$  for at least 5 seconds.

For constant speed test condition of 10 km/h, the simulated test speed  $v_{\text{test}}$  shall be 10 km/h  $\pm$  0,5 km/h.

For constant speed test condition of 20 km/h, the simulated test speed  $v_{\text{test}}$  shall be 20 km/h  $\pm$  0,5 km/h

3.3.3. Reversing tests

These tests may be conducted with the vehicle in rearward motion or with the vehicle speed simulated by an external signal to the AVAS or with the vehicle in standstill condition.

3.3.3.1. Reversing test in motion

For a vehicle tested in an outdoor facility, the path of the centreline of the vehicle shall follow line CC' as closely as possible with constant speed  $v_{\text{test}}$  throughout the entire test. The rear plane of the vehicle shall pass from the line AA' at the start of the test and the front plane of the vehicle shall pass from the line BB' at the end of the test, as shown on Figure 1b. Any trailer, which is not readily separable from the towing vehicle, shall be ignored when considering the crossing of the line BB'.

A vehicle tested in an indoor facility, shall be located with the rear plane of the vehicle on the PP' line as shown in Figure 2b. The vehicle shall maintain a constant test speed,  $v_{\text{test}}$  for at least 5 seconds.

For constant speed test condition of 6 km/h, the test speed  $v_{\text{test}}$  shall be 6 km/h  $\pm$  2 km/h.

For automatic transmission vehicles, the gear selector shall be placed as specified by the manufacturer for normal reverse driving.

For manual transmission vehicles, the gear selector shall be placed in the highest reverse gear which can achieve the target vehicle speed with constant engine speed.

3.3.3.2. Reversing test simulated by an external signal to the AVAS with the vehicle in standstill condition



A vehicle tested in an indoor or outdoor facility, shall be located with the rear plane of the vehicle on the PP' line as shown in Figure 2b. The vehicle shall maintain a constant simulated test speed,  $v_{\text{test}}$  for at least 5 seconds.

For constant test condition of 6 km/h, the simulated test speed  $v_{\text{test}}$  shall be 6 km/h  $\pm$  0,5 km/h.

#### 3.3.3.3. Reversing test in standstill condition

A vehicle tested in an indoor or outdoor facility, shall be located with the rear plane of the vehicle on the PP' line as shown in Figure 2b.

The vehicle's gear selection control shall be in the reverse position and the brake released for the test.

#### 3.4. Measurement readings and reported values

At least four measurements for each test condition shall be made on both sides of the vehicle.

The first four valid consecutive measurement results for each test condition, within 2,0 dB(A) per side, allowing for the deletion of non-valid results, shall be used for the calculation of the intermediate or final result.

If a sound peak obviously out of character with the general sound pressure level is observed, that measurement shall be discarded. For measurement of a vehicle in motion (forward and reversing) outdoor, the maximum A-weighted sound pressure level indicated during each passage of the vehicle between AA' and PP' ( $L_{\text{test},j}$ ) shall be noted for each microphone position, to the first significant digit after the decimal place (for example XX,X). For measurement of a vehicle in motion indoor and in standstill (forward and reversing), the maximum A-weighted sound pressure level indicated during each period of 5 seconds for each microphone position,  $L_{\text{test},j}$ , shall be noted, to the first significant digit after the decimal place (for example XX,X).

$L_{\text{test},j}$  shall be corrected according to paragraph 2.3.2 to obtain  $L_{\text{testcorr},j}$ .

For each maximum A-weighted sound pressure level, the corresponding one-third-octave spectrum shall be reported for each microphone position. No background correction shall be applied to any measured one-third octave result.

#### 3.5. Data compilation and reported results

For each test condition described in paragraph 3.3., the background corrected results,  $L_{\text{testcorr},j}$ , and the corresponding one third octave spectra of both sides of the vehicle individually shall be arithmetically averaged and rounded to the first decimal place.

The final A-weighted sound pressure level results  $L_{\text{crs } 10}$ ,  $L_{\text{crs } 20}$  and  $L_{\text{reverse}}$  to be reported are the lower values of the two averages of both sides, rounded to the nearest integer. The final one third octave spectra to be reported are the spectra corresponding to the same side as the reported A-weighted sound pressure level.

4. Test procedures for frequency shift

4.1. General

The provisions on frequency shift outlined in 6.2.3 of the main body shall be checked using one of the following test methods to be selected by the manufacturer:

Method (A) Test of the complete vehicle in motion on an outdoor test track

Method (B) Test of the complete vehicle in standstill condition on an outdoor test track with simulation of the vehicle movement to the AVAS by an external signal generator

Method (C) Test of the complete vehicle in motion in an indoor facility on a chassis dynamometer

Method (D) Test of the complete vehicle in standstill condition in an indoor facility with simulation of the vehicle movement to the AVAS by an external signal generator

Method (E) Test of the AVAS without a vehicle in an indoor facility with simulation of the vehicle movement to the AVAS by an external signal generator

The facility requirements as well as the vehicle and test setup specifications are the same as given in paragraphs 1, 2, 3.1 and 3.2 of this annex according to the selected test method unless the following paragraphs below provide different or additional specifications.

No background noise correction shall be applied to any measurement. Special care must be given for outdoor measurements. Any interference of the background noise shall be avoided. If a sound peak obviously out of character with the general signal is observed, that measurement shall be discarded.

4.2. Instrumentation and signal processing

Analyser settings shall be agreed between the manufacturer and the technical service to provide data according to these requirements.

The sound analysis system shall be capable of performing spectral analysis at a sampling rate and over a frequency range containing all frequencies of interest. The frequency resolution shall be sufficiently precise to differentiate between the frequencies of the various test conditions.

4.3. Test methods

4.3.1. Method (A) – Outdoor facility and vehicle in motion

The vehicle shall be operated in the same outdoor test facility and according to the same general operating condition as for the vehicle constant speed testing (paragraph 3.3.2).

The vehicle sound emission shall be measured at target speeds of 5 km/h to 20 km/h in steps of 5 km/h with a tolerance of +/- 2 km/h for the speed of 10 km/h or less and of +/- 1 km/h for any other speeds. The speed of 5 km/h is the lowest target speed. If the vehicle cannot be operated at this speed within the given precision, the lowest possible speed below 10 km/h shall be used instead.

4.3.2. Method (B) and Method (D) – Outdoor/Indoor facility and vehicle in standstill

The vehicle shall be operated in a test facility where the vehicle can accept an external vehicle speed signal to the AVAS simulating vehicle operation. The microphone locations shall be as for the complete vehicle test conditions as specified in Figure 2a. The front plane of the vehicle shall be placed on line PP'.

The vehicle sound emission shall be measured at simulated speeds of 5 km/h to 20 km/h in steps of 5 km/h with a tolerance of +/- 0.5 km/h for each test speed.

4.3.3. Method (C) – Indoor facility and vehicle in motion

The vehicle shall be installed in an indoor test facility where the vehicle can operate on a chassis dynamometer in the same manner as outdoors. All microphone locations shall be as for the vehicle test conditions as specified in Figure 2a. The front plane of the vehicle shall be placed on line PP'.

The vehicle sound emission shall be measured at target speeds of 5 km/h to 20 km/h in steps of 5 km/h with a tolerance of +/- 2 km/h for the speed of 10 km/h or less and of +/- 1 km/h for any other speeds. The speed of 5 km/h is the lowest target speed. If the vehicle cannot be operated at this speed within the given precision, the lowest possible speed below 10 km/h shall be used instead.

4.3.4. Method (E)

The AVAS shall be mounted rigidly in an indoor facility, by means of the equipment indicated by the manufacturer. The microphone of the measuring instrument shall be placed at 1 m distance from the AVAS in the direction where the subjective sound level is greatest and placed at a height of approximately the same level as the sound radiation of the AVAS.

The sound emission shall be measured at simulated speeds of 5 km/h to 20 km/h in steps of 5 km/h with a tolerance of +/- 0.5 km/h for each test speed.

4.4. Measurement Readings

4.4.1. Test Method (A)

At least four measurements shall be made at every speed specified in paragraph 4.3.1. The emitted sound shall be recorded during each passage of the vehicle between AA' and BB' for each microphone position. From each measurement sample a segment taken from AA until -1 meter before PP' shall be cut out for further analysis.

4.4.2. Test Methods (B), (C), (D) and (E)

The emitted sound shall be measured at every speed specified in correlated paragraphs above for at least 5 seconds.

4.5. Signal Processing

For each recorded sample the average auto power spectrum shall be determined, using a Hanning window and at least 66.6% overlap averages. The frequency resolution shall be chosen to be sufficiently narrow as to allow a separation of the frequency shift per target condition. The reported speed per sample segment is the average vehicle speed over the time of the sample segment rounded to the first decimal place.

In case of test method (A) the frequency that is intended to be changed with the speed shall be determined per sample segment. The reported frequency per target condition  $f_{\text{speed}}$  shall be the mathematical average of the frequencies determined per measurement sample and rounded to the nearest integer. The reported speed per target condition shall be the mathematical average of the four sample segments.

Table 4  
Analysis of the shifted frequency per target condition per side

<i>Target speed</i>	<i>Test run per target condition</i>	<i>Reported speed (average per sample segment)</i>	<i>Determined frequency of interest (<math>f_{j, \text{speed}}</math>)</i>	<i>Reported Speed per target condition (average of the reported speeds)</i>	<i>Reported frequency of interest per target condition (<math>f_{\text{speed}}</math>)</i>
<i>km/h</i>	<i>No</i>	<i>km/h</i>	<i>Hz</i>	<i>km/h</i>	<i>Hz</i>
5	1				
	2				
	3				
	4				
10	1				
	2				
	3				
	4				
15	1				
	2				
	3				
	4				
20	1				
	2				
	3				
	4				

For all other test methods the derived frequency spectrum shall directly be used for the further calculation.

#### 4.5.1. Data compilation and reported results

The frequency intended to be shifted shall be used for the further calculation. The frequency of the lowest reported test speed rounded to the nearest integer is taken as the reference frequency  $f_{\text{ref}}$ .

For the other vehicle speeds, the corresponding shifted frequencies  $f_{\text{speed}}$  rounded to the nearest integer shall be taken from the spectra analysis. Calculate  $\Delta f$ , the frequency shift of the signal according to equation (1):

$$\Delta f = \left\{ \frac{(f_{\text{speed}} - f_{\text{ref}}) \cdot (v_{\text{test}} - v_{\text{ref}})}{f_{\text{ref}} \cdot v_{\text{ref}}} \right\} \cdot 100 \quad \text{equation (1)}$$

where

$f_{\text{speed}}$  is the frequency at a given speed value;

$f_{\text{ref}}$  is the frequency at the reference speed of 5 km/h or the lowest reported speed;

$v_{\text{test}}$  is the vehicle speed, actual or simulated, corresponding to the frequency  $f_{\text{speed}}$ ;

$v_{\text{ref}}$  is the vehicle speed, actual or simulated, corresponding to the frequency  $f_{\text{ref}}$ ;

The results shall be reported using the following table:

Table 5

**Report table, to be completed for each frequency analysed**

		<i>Test Results at Target Speeds</i>			
		<i>5 km/h (Reference)</i>	<i>10 km/h</i>	<i>15 km/h</i>	<i>20 km/h</i>
Reported Speed	km/h				
Frequency, $f_{\text{speed}}$ , Left Side	Hz				
Frequency, $f_{\text{speed}}$ , Right Side	Hz				
Frequency Shift, Left Side	%	n.a.			
Frequency Shift, Right Side	%	n.a.			

## Annex 3 – Appendix

### Figures and flowcharts

Figures 1a and 1b  
Measuring positions for vehicles in motion outdoor

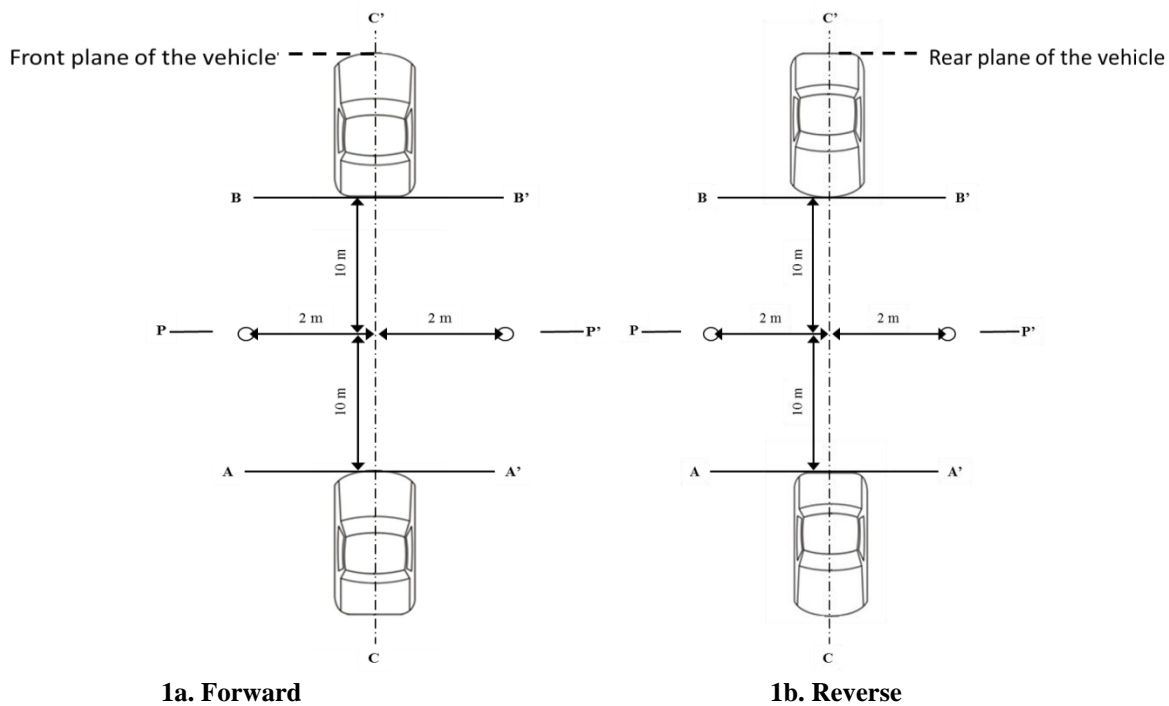

Figures 2a and 2b  
Measuring positions for vehicles in motion indoor and in standstill

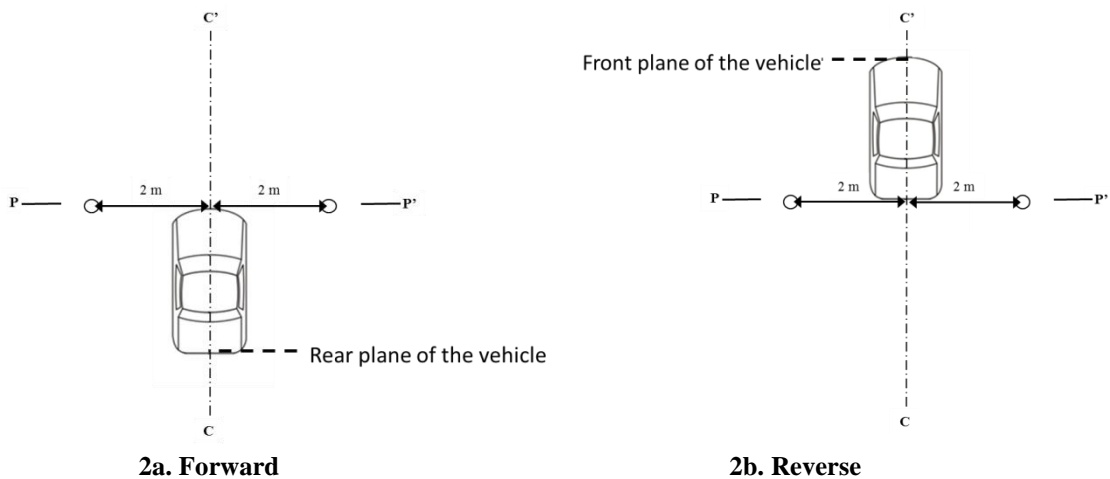

Figure 3  
Minimum space to be qualified as Semi-Anechoic chamber

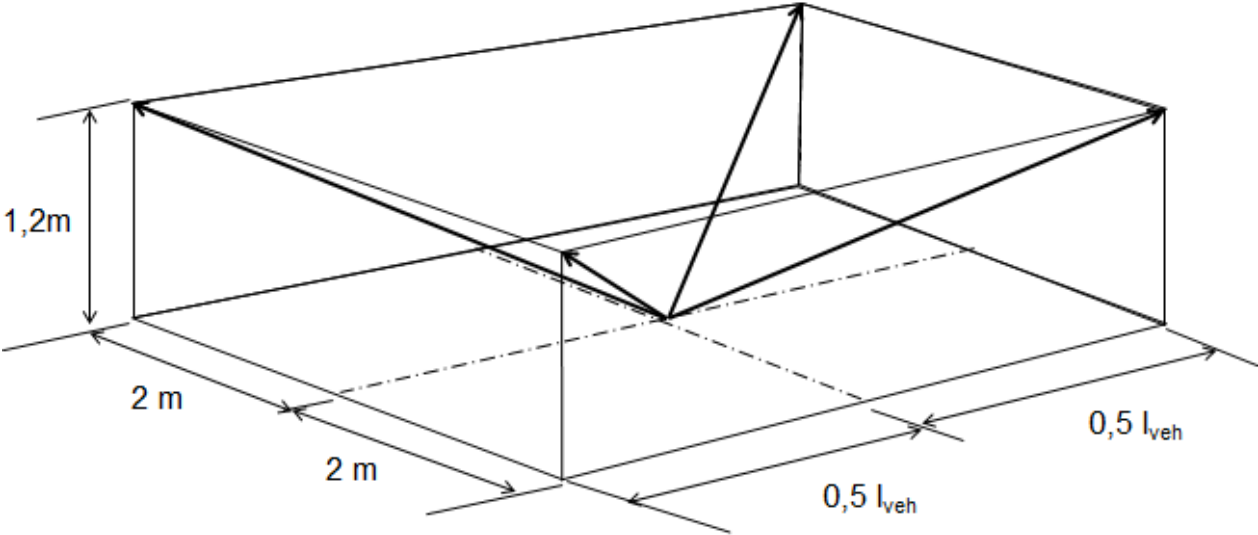

Figure 4  
**Determination of the range of background noise**

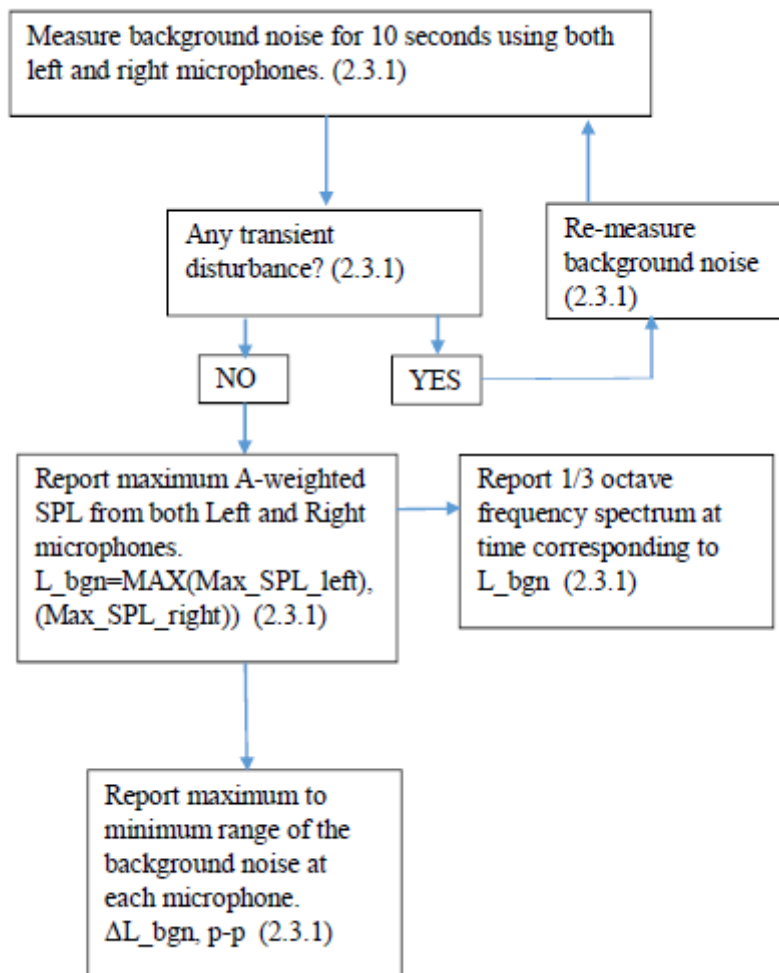



Figure 5  
Vehicle A-Weighted sound pressure level measurement correction criteria

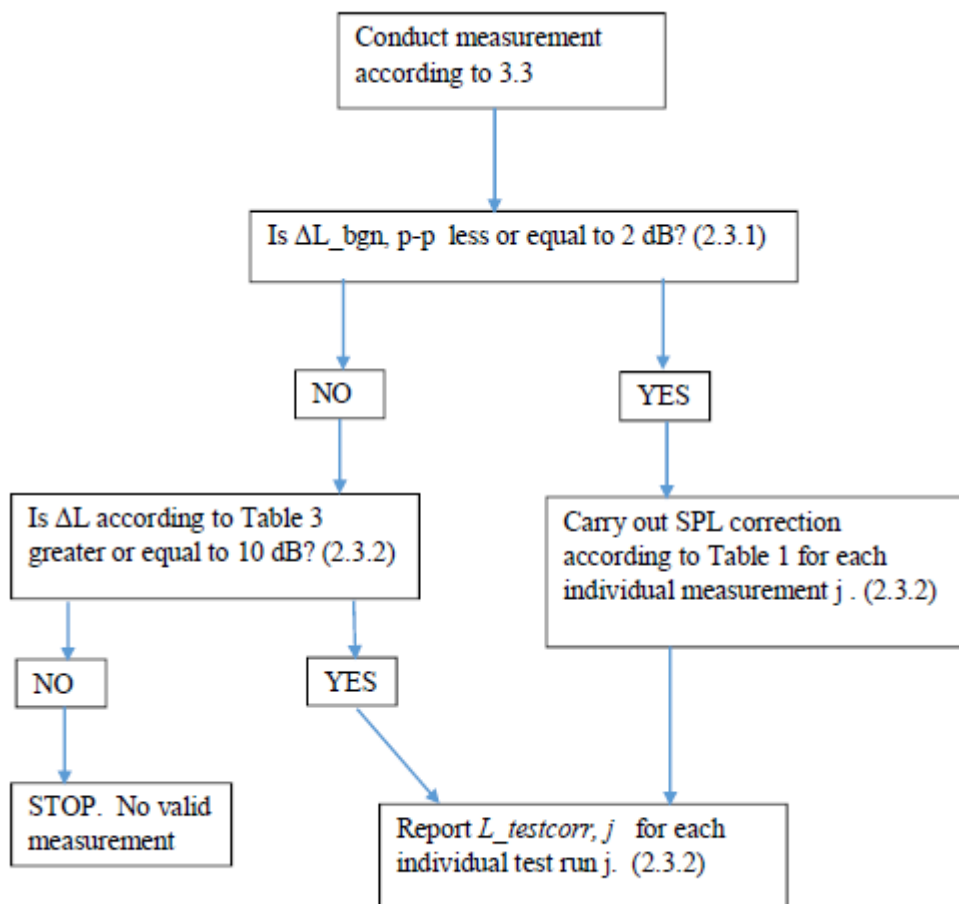

Figure 6  
Background noise requirements for analysis in one-third-octave bands

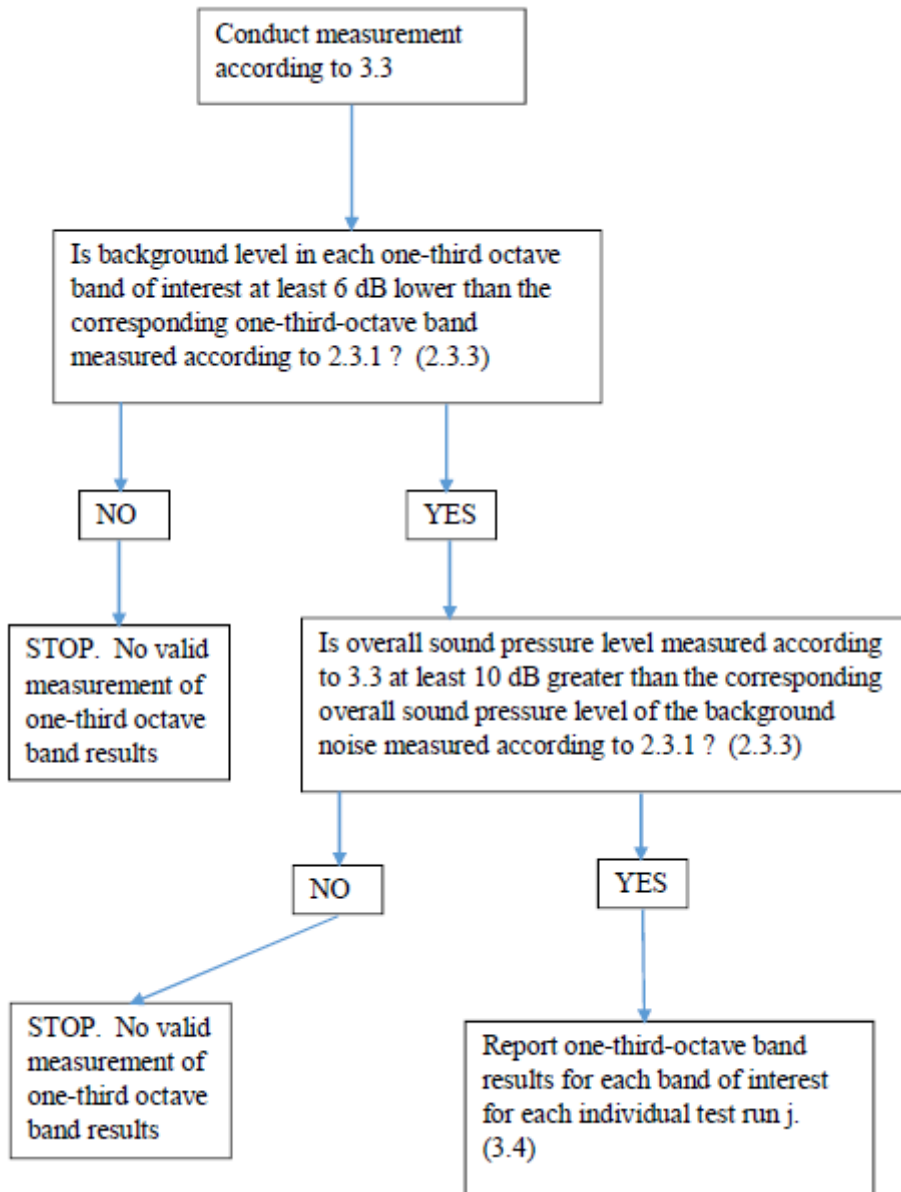

Figure 7a  
Test procedures for measurement of frequency shift

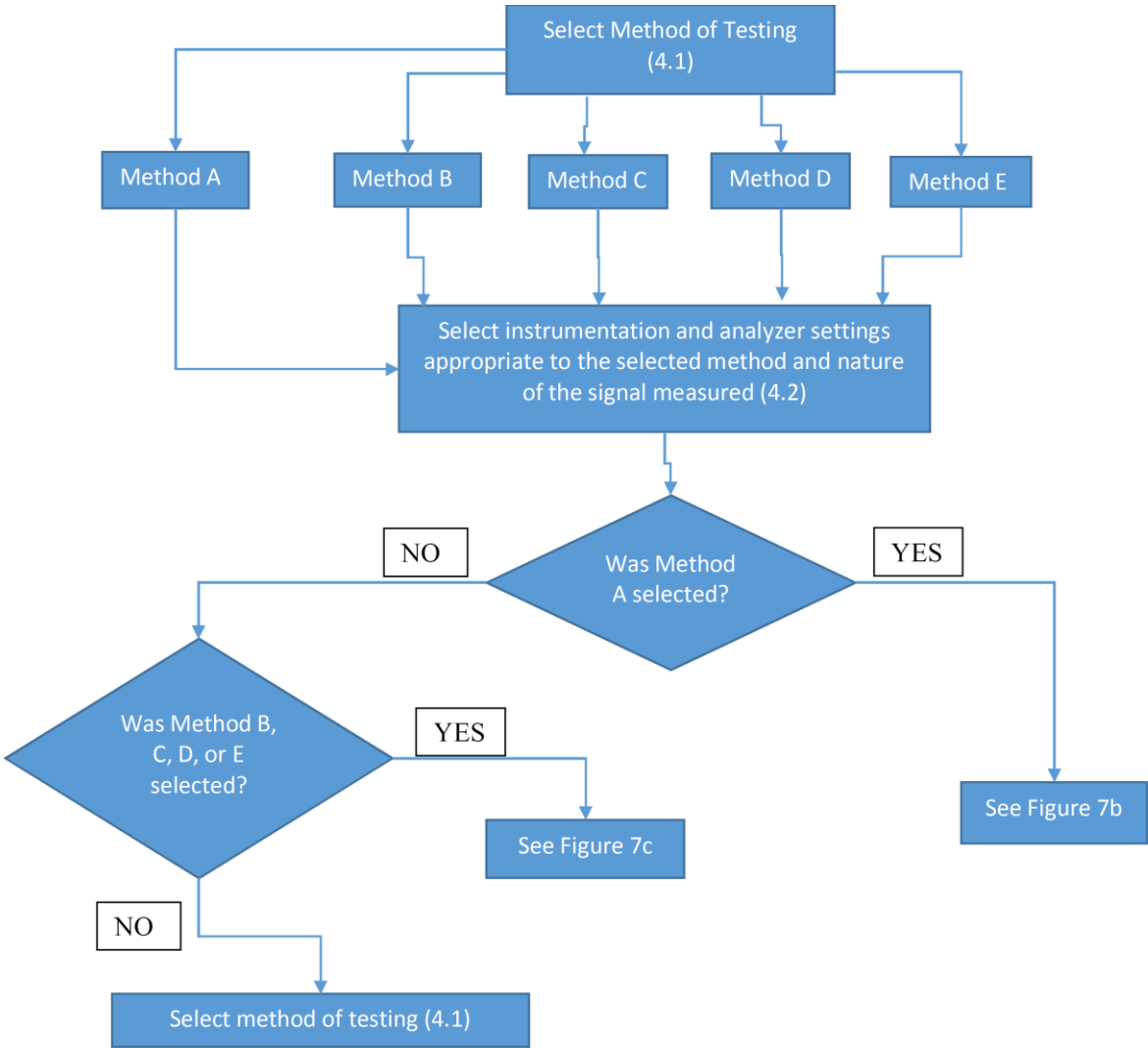

Figure 7b  
Test procedures for measurement of frequency shift, Method A

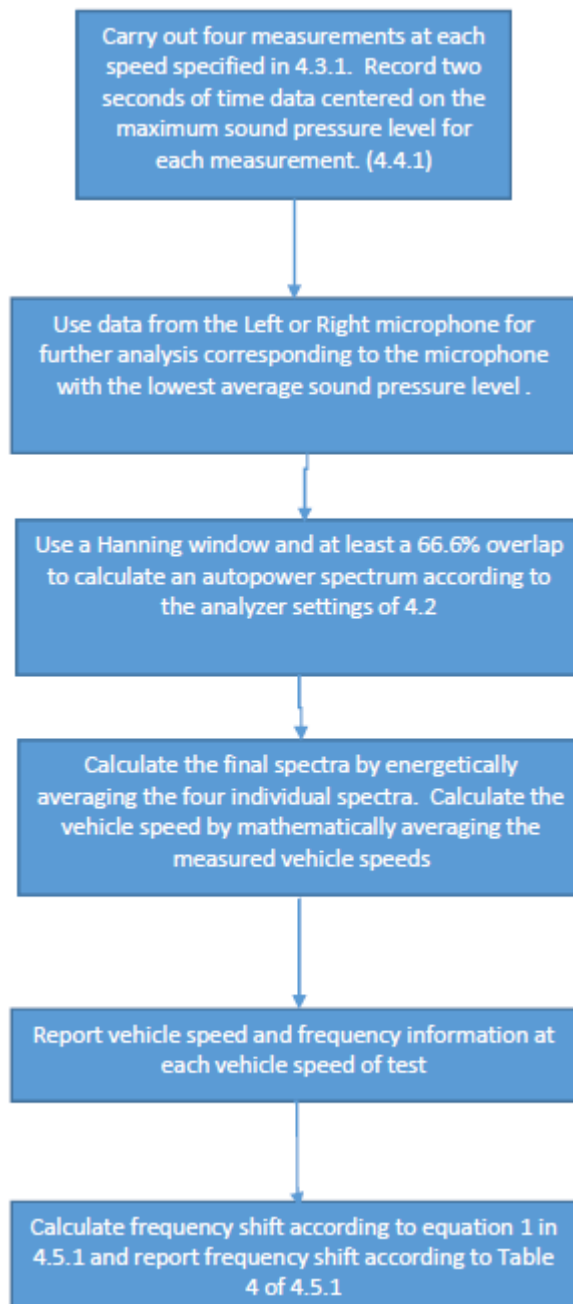

Figure 7c  
Test procedures for measurement of frequency shift, Methods B, C, D, and E

