



Economic and Social Council

Distr.: General
2 July 2012

Original: English

Economic Commission for Europe

Inland Transport Committee

World Forum for Harmonization of Vehicle Regulations

Working Party on General Safety Provisions

102nd session

Geneva, 16–20 April 2012

Report of the Working Party on General Safety Provisions on its 102nd session (16–20 April 2012)

Contents

	<i>Paragraphs</i>	<i>Page</i>
I. Attendance	1	3
II. Adoption of the agenda (agenda item 1)	2–4	3
III. Regulation No. 107 (M ₂ and M ₃ vehicles) (agenda item 2)	5–11	4
A. Proposals for further amendments (agenda item 2(a)).....	5–8	4
B. Requirements for service doors, windows and emergency exits (agenda item 2(b)).....	9–11	4
IV. Regulation No. 26 (External projections of passenger cars) (agenda item 3)	12	5
V. Regulation No. 43 (Safety glazing) (agenda item 4).....	13–14	5
VI. Regulation No. 46 (Devices for indirect vision) (agenda item 5).....	15–17	6
VII. Regulation No. 58 (Rear underrun protection) (agenda item 6).....	18–20	6
VIII. Regulation No. 61 (External projections of cab's rear panel) (agenda item 7).....	21	7
IX. Regulation No. 67 (Equipment for liquefied petroleum gases (LPG)) (agenda item 8)	22–23	7
X. Regulation No. 110 (Specific equipment for CNG) (agenda item 9).....	24–25	8
XI. Regulation No. 121 (Identification of controls, tell-tales and indicators) (agenda item 10)	26	8
XII. Regulation No. 125 (Forward field of vision of drivers) (agenda item 11)	27–28	9

XIII.	Proposal to update, in Regulation Nos. 97 (Vehicle alarm systems) and 116 (Anti-theft and alarm systems), the reference to Regulation No. 10 (agenda item 12)	29	9
XIV.	Revisions and extensions of approvals (agenda item 13).....	30–32	9
XV.	Consolidated Resolution on the Construction of Vehicles (R.E.3) (agenda item 14)	33	10
XVI.	Other business (agenda item 15)	34–38	10
	A. Controls, tell-tales and indicators for two-wheeled vehicles (agenda item 15(a)).....	34–35	10
	B. Regulation No. 118 (Burning behaviour of materials) (agenda item 15(b))...	36	11
	C. International Whole Vehicle Type Approval (agenda item 15(c))	37–38	11
XVII.	Provisional agenda for the 103 rd session	39	11
Annexes			
I.	List of informal documents considered during the session		13
II.	Draft amendments to Regulation No. 26.....		15
III.	Draft amendments to Regulation No. 46.....		17
IV.	Draft amendments to Regulation No. 58.....		19
V.	Draft amendments to Regulation No. 61.....		21
VI.	Draft amendments to Regulation No. 67.....		24
VII.	Draft amendments to Regulation No. 110.....		25
VIII.	Draft amendments to Regulation No. 121.....		28
IX.	Draft amendments to Regulation No. 125.....		29
X.	Draft amendments to Regulation Nos. 97 and 116.....		32
XI.	GRSG informal groups		34

I. Attendance

1. The Working Party on General Safety Provisions (GRSG) held its 102nd session from 16 (afternoon) to 20 April 2012 (morning) in Geneva. The meeting was chaired by Mr. A. Erario (Italy). Experts from the following countries participated in the work, following Rule 1(a) of the Rules of Procedure of the World Forum for Harmonization of Vehicle Regulations (WP.29) (TRANS/WP.29/690 and TRANS/WP.29/690/Amend.1): Canada, China, Czech Republic, Finland, France, Germany, Hungary, India, Italy, Japan, Luxembourg, Netherlands, Norway, Poland, Republic of Korea, Russian Federation, South Africa, Spain, Sweden, Switzerland, Turkey, United Kingdom of Great Britain and Northern Ireland, and United States of America. An expert from the European Commission (EC) also participated. Experts from the following non-governmental organizations participated: European Association of Automobile Suppliers (CLEPA), European Liquefied Petroleum Gas Association (AEGPL), International Motorcycle Manufacturers Association (IMMA), International Organization of Motor Vehicle Manufacturers (OICA), International Road Transport Union (IRU) and Natural Gas Vehicles Association Europe (NGVA Europe). Upon the special invitation of the Chair, an expert from the International Association of the Body and Trailer Building Industry (CLCCR) participated.

II. Adoption of the agenda (agenda item 1)

Documentation: ECE/TRANS/WP.29/GRSG/2012/1
Informal document GRSG-102-01

2. GRSG considered and adopted the agenda proposed for the 102nd session (ECE/TRANS/WP.29/GRSG/2012/1) with the addition of the following agenda items:

15(a) Controls, tell-tales and indicators for two-wheeled vehicles

15(b) Regulation No. 118 (Burning behaviour of materials)

15(c) International Whole Vehicle Type Approval

3. GRSG also adopted the running order for the session as proposed in GRSG-102-01.

4. The informal documents distributed during the session are listed in Annex I to this report.

III. Regulation No. 107 (M₂ and M₃ vehicles) (agenda item 2)

A. Proposals for further amendments (agenda item 2(a))

Documentation: ECE/TRANS/WP.29/GRSG/2010/33
ECE/TRANS/WP.29/GRSG/2012/2
ECE/TRANS/WP.29/GRSG/2012/12
Informal documents GRSG-100-06, GRSG-100-16, GRSG-102-12 and GRSG-102-27

5. The expert from EC reiterated his position on the need for an improved accessibility of prams as indicated at the previous session on the basis of GRSG-100-06 and ECE/TRANS/WP.29/GRSG/2010/33. The expert from OICA proposed alternative provisions (ECE/TRANS/WP.29/GRSG/2012/2) to provide a specific area in vehicles of Class I. The expert from France suggested differentiating between small and larger vehicles of Class I as the latter vehicles allow additional space for special area dedicated for a pram or pushchair. GRSG supported in general that proposal, but noted a number of study reservations. The expert the EC volunteered to prepare a revised proposal for consideration at the next GRSG taking into account the comments received. GRSG agreed to resume consideration of this matter at its October 2012 session and to keep ECE/TRANS/WP.29/GRSG/2012/2 on the agenda as a reference document.

6. Recalling the discussion at the previous GRSG session on GRSG-100-16, the expert from CLCCR introduced GRSG-102-12 on the lateral stability of rearward facing wheelchairs. GRSG welcomed the proposal and agreed to reconsider this matter at its next session. The secretariat was requested to distribute GRSG-102-12 with an official symbol.

7. The expert from IRU presented ECE/TRANS/WP.29/GRSG/2012/12 proposing to install in urban buses of Class I driver seats without suspension systems. GRSG noted that the choice of driver seats with or without suspension should be made by the manufacturer and operator. The expert from France and Germany raised study reservations. GRSG could not find an agreement on the proposal and agreed to resume consideration of this subject at its next session.

8. The expert from the United States of America presented the status of the motor coach safety action plan in his country (GRSG-102-27). GRSG welcomed the presentation and noted the priorities of the action plan for new requirements on the installation of safety belts, stability control systems and the roof crush performance.

B. Requirements for service doors, windows and emergency exits (agenda item 2(b))

Documentation: Informal documents GRSG-102-02, GRSG-102-03 and GRSG-102-23

9. The Chair of the informal group on Service Doors, Windows and Emergency Exits in buses and coaches (SDWEE) reported on the progress made by the group at its meeting held in Bonn on 24-25 January 2012. As a result of the informal group's activities, he introduced GRSG-102-02 proposing to insert into UN Regulation No. 107 new requirements for service doors, windows and emergency exits. He also presented GRSG-102-23 aligning the proposed text of

the transitional provisions with the guidelines recently adopted by the World Forum WP.29.

10. GRSG acknowledged the work done by the informal group and noted a number of comments especially on the new provisions to add a film on the glazing of emergency exits as proposed in new paragraph 7.6.8.7. of Annex 3. The expert from Germany preferred to insert only a reference to UN Regulation No. 43. Following the discussion, GRSG agreed to resume consideration of the proposals at its next session in October 2012. The secretariat was requested to distribute GRSG-102-02 and GRSG-102-23 with an official symbol.

11. The expert from Hungary reported on the conclusions of a severe accident in Egypt (GRSG-102-03). GRSG welcomed the information and agreed on the need to find a better compromise of the glazing material used for emergency exits and study the effectiveness of safety belts in case of rollover accidents. The expert from Hungary volunteered to prepare a concrete proposal for amendments to UN Regulation No. 107.

IV. Regulation No. 26 (External projections of passenger cars) (agenda item 3)

Documentation: ECE/TRANS/WP.29/GRSG/2012/3
Informal document GRSG-102-15

12. The expert from France introduced ECE/TRANS/WP.29/GRSG/2012/3 proposing to align the provisions for bumpers of certain vehicle types with the performance requirements of the new UN Regulation No. 128 on pedestrian safety. The expert from Germany presented GRSG-102-15 proposing to amend the definitions of bumpers. GRSG adopted ECE/TRANS/WP.29/GRSG/2012/3, as reproduced in Annex II to this report, and requested the secretariat to submit it to WP.29 and AC.1 for consideration at their November 2012 sessions, as draft Supplement 2 to the 03 series of amendments of UN Regulation No. 26.

V. Regulation No. 43 (Safety glazing) (agenda item 4)

Documentation: Informal documents GRSG-102-14 and GRSG-102-24

13. The expert from Germany reported on the work progress made by the informal group on plastic glazing (GRSG-102-14). He added that the group was still waiting for the results of the abrasion test still under discussion by the International Standard Organization (ISO) working group, especially with respect to the influence of the quality of the abrasion wheels. GRSG welcomed the information and noted some comments.

14. The expert from Germany introduced GRSG-102-24 proposing to amend UN Regulation No. 43 to allow type approval of multiple-glazed units having more than two glass panes. GRSG noted a number of comments. The expert from CLEPA raised a study reservation and underlined the need to also align UN Global Technical Regulation (UN GTR) No. 6 on safety glazing. GRSG agreed to resume consideration of this subject at its next session in October 2012 on the basis of an official document. GRSG invited the expert from Germany to transmit in due time to the secretariat an updated proposal taking into account the comments received and a proposal for transitional provisions, if necessary.

VI. Regulation No. 46 (Devices for indirect vision) (agenda item 5)

Documentation: ECE/TRANS/WP.29/GRSG/2010/29/Rev.1
ECE/TRANS/WP.29/GRSG/2011/23
ECE/TRANS/WP.29/GRSG/2012/4
Informal documents GRSG-102-04, GRSG-102-16, GRSG-102-29-Rev.1 and GRSG-102-31

15. Referring to the discussion at the previous session of GRSG on ECE/TRANS/WP.29/GRSG/2010/29/Rev.1, the expert from the United Kingdom introduced GRSG-102-29 proposing to reduce the blind spot on the passenger side of N₂ and N₃ vehicles. GRSG noted a number of concerns by the experts from the Netherlands, France and OICA. Following the discussion, the expert from the United Kingdom presented a revised proposal (GRSG-102-29-Rev.1). GRSG adopted the proposal, as reproduced in Annex III, and requested the secretariat to submit it to WP.29 and AC.1 for consideration at their November 2012 sessions, as draft 04 series of amendments to UN Regulation No. 46.

16. The expert from OICA presented GRSG-102-16 proposing the installation of a new generation of exterior and interior mirrors enclosed in a protective housing or holder. The proposal received a number of comments. GRSG agreed to resume consideration of the proposal at its next session in October 2012 on the basis of an official document.

17. Recalling the purpose of ECE/TRANS/WP.29/GRSG/2011/23, the expert from CLEPA introduced ECE/TRANS/WP.29/GRSG/2012/4 and GRSG-102-04 improving the provisions on camera-monitor systems. GRSG noted a number of concerns on the approval marking. The expert from the EC underlined the importance of replacing all mirrors by camera-monitor systems. He volunteered to prepare for the next GRSG session a presentation on the impact of such systems on road safety. The expert from Germany reported (GRSG-102-31) on the work progress made by the ISO working group on the standardization of camera monitoring systems (ISO 16505). The expert from the Netherlands volunteered to prepare for the next session of GRSG a revised proposal taking into account the comments received and the outcome of the ISO working group.

VII. Regulation No. 58 (Rear underrun protection) (agenda item 6)

Documentation: ECE/TRANS/WP.29/GRSG/2011/19
ECE/TRANS/WP.29/GRSG/2012/5
Informal documents GRSG-102-26, GRSG-102-32-Rev.1, GRSG-102-34 and GRSG-102-35

18. The expert from Germany recalled the discussion at the previous session of GRSG on ECE/TRANS/WP.29/GRSG/2011/19 proposing to introduce, into UN Regulation No. 58, more stringent requirements for rear underrun protection devices. He reported on the outcome of the ad hoc expert meeting held in Bonn on 23 January 2012. As a result, he introduced GRSG-102-26 superseding ECE/TRANS/WP.29/GRSG/2011/19. The expert from OICA presented GRSG-102-32-Rev.1 containing preliminary comments to GRSG-102-26. GRSG welcomed the proposals and noted a number of comments, especially on the need to clarify the scope of the proposed amendments. The expert from France raised

concerns on the interpretation of the text of the Regulation. He underlined the need to clarify the current provisions of the measurement method (static test). The expert from Japan introduced GRSG-102-34 commenting the proposal tabled by OICA.

19. Following the discussion, GRSG invited the interested experts to discuss, at a further meeting, the open issues taking into account the comments received. GRSG agreed to resume consideration on this subject at its next session in October 2012 on the basis of a revised proposal to be submitted by Germany as the outcome of the ad hoc expert group meeting. The expert from Germany volunteered to organize that event and invited all GRSG experts to attend the meeting.

20. The expert from Japan presented ECE/TRANS/WP.29/GRSG/2012/5 clarifying the requirements on rear underrun protection devices. GRSG noted a number of amendments (GRSG-102-35) and adopted the proposal as reproduced in Annex IV to this report. GRSG requested the secretariat to submit it to WP.29 and AC.1 for consideration at their November 2012 sessions, as draft Supplement 3 to the 02 series of amendments to UN Regulation No. 58.

VIII. Regulation No. 61 (External projections of cab's rear panel) (agenda item 7)

Documentation: ECE/TRANS/WP.29/GRSG/2012/6
Informal document GRSG-102-17

21. The expert from France introduced ECE/TRANS/WP.29/GRSG/2012/6 proposing to insert into UN Regulation No. 61 an exemption from the geometric provisions for bumpers, when the vehicle comply with the performance requirements specified in the new UN Regulation No. 128 on pedestrian safety. The expert from Germany proposed further clarifications to the definitions in the Regulation (GRSG-102-17). GRSG adopted ECE/TRANS/WP.29/GRSG/2012/6, as reproduced in Annex V to this report, and requested the secretariat to submit it to WP.29 and AC.1 for consideration at their November 2012 sessions, as draft Supplement 2 to UN Regulation No. 61.

IX. Regulation No. 67 (Equipment for liquefied petroleum gases (LPG)) (agenda item 8)

Documentation: ECE/TRANS/WP.29/GRSG/2011/26
ECE/TRANS/WP.29/GRSG/2012/7
ECE/TRANS/WP.29/GRSG/2012/8
Informal documents GRSG-102-13, GRSG-102-18-Rev.1,
GRSG-102-19, GRSG-102-20 and GRSG-102-33

22. The expert from Germany proposed to clarify the provisions of UN Regulation No. 67 and introduced GRSG-102-20 superseding ECE/TRANS/WP.29/GRSG/2011/26. The expert from AEGPL presented GRSG-102-33 and GRSG-102-13 containing additional amendments to the Regulation. The proposals received a number of comments. GRSG agreed to resume consideration of this subject at its next session and requested the secretariat to distribute GRSG-102-13, GRSG-102-20 and GRSG-102-33 with official symbols.

23. The expert from OICA presented GRSG-102-18-Rev.1 superseding ECE/TRANS/WP.29/GRSG/2012/7 aimed at correcting some erroneous prescriptions in UN Regulation No. 67. For the same purpose, he introduced GRSG-102-19 amending ECE/TRANS/WP.29/GRSG/2012/8. GRSG adopted both documents, as reproduced in Annex VI to this report, and requested the secretariat to submit it to WP.29 and AC.1 for consideration at their November 2012 sessions, as draft Supplement 11 to the 01 series of amendments to UN Regulation No. 67.

X. Regulation No. 110 (Specific equipment for CNG) (agenda item 9)

Documentation: ECE/TRANS/WP.29/GRSG/2012/9
Informal documents GRSG-102-21 and GRSG-102-25

24. The expert from the Czech Republic introduced ECE/TRANS/WP.29/GRSG/2012/9 proposing to clarify, in UN Regulation No. 110, the general test provisions on fuel rail. The expert from OICA welcomed the new provisions, but underlined the need to also insert transitional provisions as specified in GRSG-102-21. GRSG adopted ECE/TRANS/WP.29/GRSG/2012/9, as amended in Annex VII to this report, and requested the secretariat to submit it to WP.29 and AC.1 for consideration at their November 2012 sessions, as a new draft 01 series of amendments to UN Regulation No. 110.

25. The expert from AEGPL reported on the outcome of the most recent expert meetings of the task force on Liquefied Natural Gas vehicles (LNG), held in Brussels in November 2011, February and March 2012. GRSG welcome the information presented in GRSG-102-25 and noted that the next LNG meeting was scheduled to be held in Geneva, on 6 June 2012. The expert from AEGPL announced the intention of the LNG task force to prepare a concrete proposal for amendments to UN Regulation No. 110, for consideration at the next GRSG session in October 2012. He added that more detailed informal were made available at: <http://www.unece.org/trans/main/wp29/wp29wgs/wp29grpe/gfv-lng04.html>.

XI. Regulation No. 121 (Identification of controls, tell-tales and indicators) (agenda item 10)

Documentation: ECE/TRANS/WP.29/GRSG/2010/20
ECE/TRANS/WP.29/GRSG/2011/32
ECE/TRANS/WP.29/GRSG/2012/11
Informal document GRSG-102-22

26. Recalling the discussion on UN Regulation No. 121 at its previous session, GRSG agreed to remove ECE/TRANS/WP.29/GRSG/2010/20 from the agenda. GRSG considered generic provisions for symbols of automatic systems and agreed on ECE/TRANS/WP.29/GRSG/2012/11. The expert from OICA introduced GRSG-102-22 superseding ECE/TRANS/WP.29/GRSG/2011/32 and proposing to extend symbol Nos. 25 and 28 to the logics of the ISO colour coding and its hierarchy of alerts to the danger. GRSG adopted both documents, as reproduced in Annex VIII to this report, and requested the secretariat to submit it to WP.29 and AC.1 for consideration at their November 2012 sessions, as draft Supplement 8 to UN Regulation No. 121.

XII. Regulation No. 125 (Forward field of vision of drivers) (agenda item 11)

Documentation: ECE/TRANS/WP.29/GRSG/2011/31
ECE/TRANS/WP.29/GRSG/2012/10
Informal document GRSG-102-30

27. The expert from Japan introduced ECE/TRANS/WP.29/GRSG/2012/10 (superseding ECE/TRANS/WP.29/GRSG/2011/31) improving the perception by the driver of other road users. The expert from the United Kingdom raised concerns on the proposed text of paragraph 5.1.4. with respect to A pillars. Following the discussion, GRSG agreed on the proposal as amended in GRSG-102-30.

28. GRSG adopted ECE/TRANS/WP.29/GRSG/2012/10, as reproduced in Annex IX to this report, and requested the secretariat to submit it to WP.29 and AC.1 for consideration at their November 2012 sessions, as a new draft 01 series of amendments to UN Regulation No. 125.

XIII. Proposal to update, in Regulation Nos. 97 (Vehicle alarm systems) and 116 (Anti-theft and alarm systems), the reference to Regulation No. 10 (agenda item 12)

Documentation: ECE/TRANS/WP.29/GRSG/2011/28
ECE/TRANS/WP.29/GRSG/2011/29
Informal documents GRSG-102-06 and GRSG-102-07

29. Referring to the discussion at the previous session of GRSG on ECE/TRANS/WP.29/GRSG/2011/28 and ECE/TRANS/WP.29/GRSG/2011/29, the expert from Japan introduced GRSG-102-06 and GRSG-102-07, proposing to align, in UN Regulation Nos. 97 and 116, the reference to UN Regulation No. 10. GRSG adopted both documents, as reproduced in Annex X to this report, and requested the secretariat to submit them to WP.29 and AC.1 for consideration at their November 2012 sessions, as draft Supplement 7 to the 01 series of amendments to UN Regulation No. 97 respectively as draft Supplement 4 to UN Regulation No. 116.

XIV. Revisions and extensions of approvals (agenda item 13)

Documentation: ECE/TRANS/WP.29/GRSG/2011/22
Informal documents GRSG-102-05 and GRSG-102-28

30. GRSG noted that the revised general guidelines for UN regulatory procedures and transitional provisions in UN Regulations (ECE/TRANS/WP.29/1044/Rev.1) were now available on the UNECE website at: www.unece.org/trans/main/wp29/wp29wgs/wp29gen/wp29transprov.html

31. The GRSG Chair invited all experts to use this document when preparing future proposals for amendments especially with respect to transitional provisions.

32. Referring to the discussion at the previous session of GRSG on ECE/TRANS/WP.29/GRSG/2011/22, the expert from the Netherlands presented GRSG-102-28 (superseding GRSG-102-05) clarifying in UN Regulation No. 61 the communication form to include withdrawal and extension of approvals. GRSG

adopted the proposal, as reproduced in Annex V to this report, and requested the secretariat to submit it to WP.29 and AC.1 for consideration at their November 2012 sessions, as part (see para. 21 above) of draft Supplement 2 to UN Regulation No. 61. The Chair reminded GRSG experts to include, if appropriate, into their proposals provisions for the withdrawal and extension of approvals, when preparing an amendment to an existing UN Regulation.

XV. Consolidated Resolution on the Construction of Vehicles (R.E.3) (agenda item 14)

Documentation: ECE/TRANS/WP.29/GRSG/2011/30

33. The expert from the Russian Federation recalled the discussion at its previous session on ECE/TRANS/WP.29/GRSG/2011/30 proposing to amend the definition of N₁ vehicles to take into account the special design of electric vehicles. The proposal received a number of concerns. Recognizing the efforts by the Russian Federation to foster new technologies, GRSG noted no support for the proposal and agreed to remove the document from the agenda.

XVI. Other business (agenda item 15)

A. Controls, tell-tales and indicators for two-wheeled vehicles (agenda item 15(a))

Documentation: Informal documents GRSG-102-08, GRSG-102-09 and GRSG-102-10

34. The expert from IMMA presented GRSG-102-08 containing a consolidated version of UN Regulation No. 60 and aligning the text with new UN GTR No. 12 on motorcycle controls, tell-tales and indicators. He introduced GRSG-102-09 and GRSG-102-10 introducing editorial corrections to the revised text of UN Regulation No. 60 respectively UN GTR No. 12. GRSG noted some comments and agreed to resume consideration of this subject at its next session in October 2012. The secretariat was requested to distribute the three informal documents with an official symbol. In this respect, GRSG agreed to merge GRSG-102-08 and GRSG-102-09 in one official document.

35. The expert from Italy volunteered to prepare a proposal to develop Amendment 1 to UN GTR No. 12 for consideration at the next WP.29 and AC.3 sessions in June 2012.

B. Regulation No. 118 (Burning behaviour of materials) (agenda item 15(b))

Documentation: Informal document GRSG-102-11

36. The expert from Germany presented GRSG-102-11 aiming at clarifying the provisions of UN Regulation No. 118 concerning the interior materials which need to be tested. GRSG welcomed the proposals and noted a number of comments. GRSG agreed to resume consideration of this subject at its next session. The secretariat was requested to distribute GRSG-102-11 with an official symbol.

C. International Whole Vehicle Type Approval (agenda item 15(c))

Documentation: Informal document WP.29-156-21

37. The secretariat informed GRSG about the work progress of the WP.29 informal group on International Whole Vehicle Type Approval (IWVTA). GRSG acknowledged the leading role of Japan and the EC on this subject. Referring to WP.29-156-21, GRSG noted the following comments:

- (a) item 55 on "Advance warning triangle" should be listed under the responsibility of the Working Party on Lighting and Light-Signalling (GRE);
- (b) the purpose of item 41 (Engine and power-train system) should be clarified with more detailed information.

38. GRSG agreed to insert on its agenda a new item on IWVTA to discuss in detail future proposals on this subject. The expert from Japan volunteered to prepare concrete proposals on UN Regulation Nos. 34 (Fuel tanks) and 46 (Indirect vision devices) for consideration at the next GRSG session in October 2012. GRSG welcomed the IWVTA concept and the commitment of Mr. O. Fontaine (OICA) ensuring the task of the "IWVTA Ambassador" to GRSG.

XVII. Provisional agenda for the 103rd session

39. The following provisional agenda was adopted for the 103rd session of GRSG, scheduled to be held in Geneva from 2 (starting at 2.30 p.m.) to 5 (concluding at 12.30 p.m.) October 2012 ¹:

1. Adoption of the agenda.
2. Regulation No. 107 (M₂ and M₃ vehicles):
 - (a) Proposals for further amendments;
 - (b) Requirements for service doors, windows and emergency exits.
3. Regulation No. 43 (Safety glazing).
4. Regulation No. 46 (Devices for indirect vision).
5. Regulation No. 58 (Rear underrun protection).

¹ GRSG noted that the deadline for submission of official documents to the UNECE secretariat was 6 July 2012, twelve weeks prior to the session.

6. Regulation No. 67 (Equipment for liquefied petroleum gases (LPG)).
7. Regulation No. 110 (Specific components for CNG).
8. Regulation No. 118 (Burning behaviour).
9. Regulation No. 125 (Forward field of vision of drivers).
10. Revisions and extensions of approvals.
11. Controls, tell-tales and indicators for two-wheeled vehicles
12. International Whole Vehicle Type Approval
13. Election of officers
14. Other business.

Annex I

List of informal documents considered during the session

List of informal documents (GRSG-102-...) distributed during the session (English only)

<i>No.</i>	<i>(Author) Title</i>	<i>Follow-up</i>
1	(GRSG Chairman) Running order of the 102 nd session	(f)
2	(SDWEE) Proposal for amendments to Regulation No. 107	(c)
3	(Hungary) Conclusions of a severe accident	(f)
4- Rev.1	(CLEPA) Proposal for amendments to ECE/TRANS/WP.29/GRSG/2011/25 (Regulation No. 46 (Devices for indirect vision))	(f)
5	(Netherlands) Proposal for amendments to Regulation No. 61	(f)
6- Rev.1	(Japan) Corrigendum to ECE/TRANS/WP.29/GRSG/2011/28	(b)
7	(Japan) Corrigendum to ECE/TRANS/WP.29/GRSG/2011/29	(b)
8	(IMMA) Proposal for amendments to Regulation No. 60 (Motorcycle controls, tell-tales and indicators) - Revision	(c)
9	(IMMA) Proposal for amendments to Regulation No. 60 (Motorcycle controls, tell-tales and indicators) – Amendment to the revision	(c)
10	(IMMA) Proposal for amendments to GTR No. 12 on motorcycle controls, tell-tales and indicators	(c)
11	(Germany) Proposal for Supplement 1 to Regulation No. 118/01 (Burning behaviour of materials)	(c)
12	(CLCCR) Proposal for draft amendments to Regulation No. 107 (M ₂ and M ₃ vehicles)	(c)
13	(AEGPL) Corrigendum to ECE/TRANS/WP.29/GRSG/2011/14 (Regulation No. 67)	(c)
14	(Germany) 3rd progress report of the Informal group on Plastic Glazing	(f)
15	(Germany) Proposal for amendments to Regulation No. 26 (External projections of passenger cars)	(b)
16	(OICA) Proposal to amend ECE/TRANS/WP.29/GRSG/2011/23 (Draft amendments to Regulation No. 46 (Systems for indirect vision))	(c)
17	(OICA) Proposal for amendments to Regulation No. 61 (External projections of cab's rear panel)	(b)
18- Rev.1	(OICA) Adopted proposal for amendments to Regulation No. 67 (LPG equipment)	(a)
19	(OICA) Proposal for amendments to Regulation No. 67 (LPG equipment)	(a)
20	(Germany) Proposal for amendments to Regulation No. 67 (LPG equipment)	(c)
21	(OICA) Proposal for amendments to Regulation No. 110 (Specific equipment for CNG)	(b)
22	(OICA) Proposal for amendments to Regulation No. 121 (Identification of controls)	(b)

<i>No.</i>	<i>(Author) Title</i>	<i>Follow-up</i>
23	(SDWEE) Proposal for amendments to Regulation No. 107 (M2 and M3 vehicles)	(c)
24	(Germany) Draft amendments to the 01 series of amendments to Regulation No. 43 (Safety glazing)	(e)
25	(NGVA Europe) Report of the activities to the GRSG 102nd session	(f)
26	(Germany) Proposal for amendments to Regulation No. 58 (Rear underrun protection)	(f)
27	(USA) Status of NHTSA's motorcoach safety efforts	(f)
28	(Netherlands) Proposal for amendments to Regulation No. 61 (External projections forward of the cab's rear panel)	(b)
29-Rev.1	(United Kingdom) Adopted amendment of ECE/TRANS/WP.29/GRSG/2010/29/Rev.1 (Regulation No. 46)	(b)
30	(Secretariat) Amendments to ECE/TRANS/WP.29/GRSG/2012/10 (Regulation No. 125)	(a)
31	(Germany) 1st Progress report if ISO/TC22/SC17/WG2 (ISO 16505 on Camera Monitoring Systems)	(f)
32-Rev.1	(OICA) Proposal for draft amendments to Regulation No. 58 (RUPD)	(f)
33	(AEGPL) Comments on GRSG-102-20 (Proposal for amendments to Regulation No. 67)	(c)
34	(Japan) Japan's comments on the proposed amendments to Regulation No. 58	(f)
35	(Secretariat) Adopted proposal for amendments to Regulation No. 58 (RUPD)	(a)

Reconsideration of informal documents from the previous sessions of GRSG or other Working Parties (English only)

<i>No.</i>	<i>(Author) Title</i>	<i>Follow-up</i>
GRSG-100-06	(EC) Proposal for an amendment to Regulation No 107 (M ₂ and M ₃ vehicles)	(f)
GRSG-100-16	(CLCCR) Proposal for draft amendments to Regulation No. 107 (M ₂ and M ₃ vehicles)	(f)
WP.29-156-21	(IWVTA) Proposal for "Candidate items for technical regulations applicable to IWVTA" and "Guideline for GRs to review technical regulations applicable to IWVTA"	(d)

Notes:

- (a) Adopted with no change and submitted to WP.29 for consideration.
- (b) Adopted with changes and submitted to WP.29 for consideration.
- (c) Resume consideration on the basis of an official document.
- (d) Kept as reference document/continue consideration.
- (e) Revised proposal for the next session.
- (f) Consideration completed or to be superseded.

Annex II

Draft amendments to Regulation No. 26 (para. 12)

Draft Supplement 2 to the 03 series of amendments to Regulation No. 26 (External projections of passenger cars)

Add new paragraphs 2.11. and 2.12., to read:

- "2.11. "Bumper" means the front or rear, lower, outer structure of a vehicle. It includes all structures that are intended to give protection to a vehicle when involved in a low speed frontal or rear collision and also any attachments to this structure.
- 2.12. "Bumper cover" means the non-rigid outer surface of a bumper, generally extending across the full width of the front or rear of a vehicle."

Add a new paragraph 6.5.4., to read:

- "6.5.4. The requirement of paragraph 6.5.2. does not apply to the bumper cover. The provisions of paragraph 5. of this Regulation remain applicable."

Paragraph 7., amend to read:

- "7. MODIFICATION OF THE VEHICLE TYPE
- 7.1. Every modification to **an existing vehicle type shall be notified to the Type Approval Authority which approved the vehicle type. The Type Approval Authority shall then either:**
- (a) **decide, in consultation with the manufacturer, that a new type-approval is to be granted, or**
 - (b) **apply the procedure contained in paragraph 7.1.1. (Revision) and, if applicable, the procedure contained in paragraph 7.1.2. (Extension).**
- 7.1.1. **Revision**
- When particulars recorded in the information folder have changed and the Type Approval Authority considers that the modifications made are unlikely to have an appreciable adverse effect and that in any case the vehicle still complies with the requirements, the modification shall be designated a "revision".**
- In such a case, the Type Approval Authority shall issue the revised pages of the information folder as necessary, marking each revised page to show clearly the nature of the modification and the date of re-issue. A consolidated updated version of the information folder, accompanied by a detailed description of the modification, shall be deemed to meet this requirement.**
- 7.1.2. **Extension**
- The modification shall be designated an "extension" if, in addition to the change of the particulars recorded in the information folder,**
- (a) **further inspections or tests are required, or**

- (b) any information on the communication document (with the exception of its attachments) has changed, or
- (c) approval to a later series of amendments is requested after its entry into force.

7.2. Confirmation or refusal of approval, specifying the alterations shall be communicated by the procedure specified in paragraph 4.3. above to the Parties to the Agreement which apply this Regulation. **In addition, the index to the information package, attached to the communication document, shall be amended accordingly to show the date of the most recent revision or extension."**

Annex III

Draft amendments to Regulation No. 46 (para. 15)

Draft 04 series of amendments to Regulation No. 46

ECE/TRANS/WP.29/GRSG/2010/29/Rev.1 was adopted as reproduced below:

Insert new paragraphs 15.2.4.5.6. to 15.2.4.5.13. (including new Figures 8c and 8d), to read:

- "15.2.4.5.6. on the passenger side only, the field of vision shall also be such that the driver can see a flat horizontal portion of the road along the side of the vehicle which is outside the field defined in paragraphs 15.2.4.5.1. to 15.2.4.5.4. but within the field bounded by the following vertical planes; the front of this field of vision may be rounded off with a radius of 2,000 mm (see Figures 8c and 8d):
- 15.2.4.5.7. in the transverse direction, the parallel plane passing at a distance of 4.5 m in front of the plane mentioned in paragraph 15.2.4.5.1.
- 15.2.4.5.8. to the rear, the plane parallel to the vertical plane passing through the driver's ocular points and situated at a distance of 1.75 m behind that plane.
- 15.2.4.5.9. to the front, the plane parallel to the vertical plane passing through the driver's ocular points and situated at a distance of 3 m in front of that plane. This field of vision may be partially provided by a front mirror (Class VI).
- 15.2.4.5.10. The field of vision prescribed in paragraphs 15.2.4.5.6. to 15.2.4.5.9. may be partially provided by a 'wide-angle' exterior mirror (Class IV) or a combination of a close-proximity exterior mirror (Class V) and a front mirror (Class VI).
- 15.2.4.5.11. The area prescribed in paragraphs 15.2.4.5.6. to 15.2.4.5.9. may be viewed using a combination of direct view and indirect vision devices.
- 15.2.4.5.12. Paragraphs 15.2.4.5.6. to 15.2.4.5.9. shall not apply to a vehicle where no part of the mirror, or its holder, is less than 2.4 m above the ground, regardless of its position after adjustment.
- 15.2.4.5.13. Paragraphs 15.2.4.5.6. to 15.2.4.5.9. shall not apply to a vehicle of category M₂ or M₃."

Figures 8c and 8d:
Larger field of vision on the passenger side

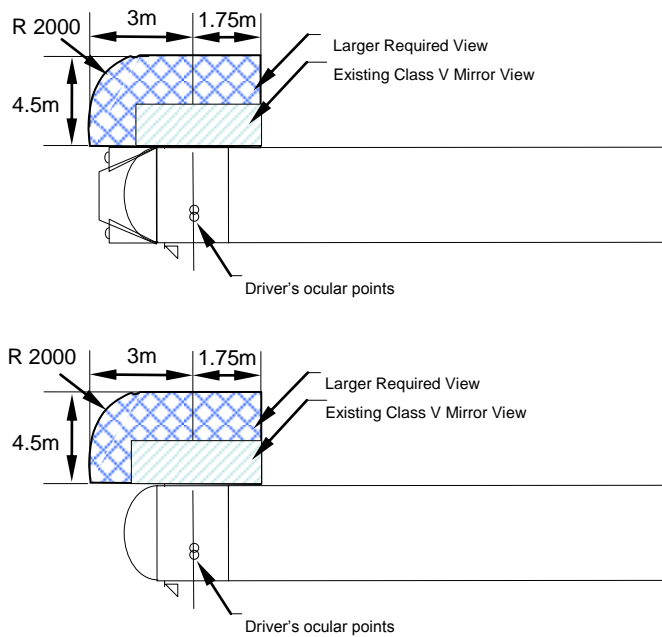

..

Add new paragraphs 21.12. to 21.15., to read:

- 21.12. As from the official date of entry into force of the 04 series of amendments to this Regulation, no Contracting Party applying this Regulation shall refuse an application for approval under this Regulation as amended by the 04 series of amendments.
- 21.13. As from 30 June 2014, Contracting Parties applying this Regulation shall grant approvals to a type of device for indirect vision only if the type of device meets the requirements of this Regulation as amended by the 04 series of amendments.
- 21.14. As from 30 June 2014, Contracting Parties applying this Regulation shall grant approvals to a type of vehicle with regard to the installation of devices for indirect vision only if the type of vehicle meets the requirements of this Regulation as amended by the 04 series of amendments.
- 21.15. As from 30 June 2015, Contracting Parties applying this Regulation shall not be obliged to accept approvals of a type of vehicle or type of device for indirect vision which have not been granted in accordance with the 04 series of amendments to this Regulation.

Annex IV

Draft amendments to Regulation No. 58 (para. 20)

Supplement 3 to the 02 series of amendments to Regulation No. 58

Paragraph 16.2., amend to read:

- "16.2. The width of the rear protective device shall at no point exceed the width of the rear axle measured at the outermost points of the wheels, excluding the bulging of the tyres close to the ground, **nor shall RUPD be more than 100 mm shorter on either side. Where the device is contained in or comprises the vehicle bodywork which itself extends beyond the width of the rear axle, the requirement, that the width of the RUPD shall not exceed that of the rear axle, shall not apply.** However, in case of vehicles of categories O₁ and O₂ where the tyres project for more than half of their width outside the bodywork (excluding the wheel guards) or outside the chassis in the absence of bodywork, the width of the RUPD shall not be less than 100 mm deducted from the distance measured between the innermost points of the tyres, **excluding the bulging of the tyres close to the ground, on either side.** Where there is more than one rear axle, the width to be considered is that of the widest rear axle. In addition the requirements of paragraphs 3.1.2. and 3.1.3. of Annex 5 relating the distance of the points of application of the test forces from the outer edges of the rear wheels (Annex 1, item 7) shall be verified and recorded in the type approval communication form."

Paragraph 25.3., amend to read:

- "25.3. The width of the rear protective device shall at no point exceed the width of the rear axle measured at the outermost points of the wheels, excluding the bulging of the tyres close to the ground, **nor shall RUPD be more than 100 mm shorter on either side. Where the device is contained in or comprises the vehicle bodywork which itself extends beyond the width of the rear axle, the requirement, that the width of the RUPD shall not exceed that of the rear axle, shall not apply.** However, in case of vehicles of categories O₁ and O₂ where the tyres project for more than half of their width outside the bodywork (excluding the wheel guards) or outside the chassis in the absence of bodywork, the width of the RUPD shall not be less than 100 mm deducted from the distance measured between the innermost points of the tyres, excluding the bulging of the tyres close to the ground, on either side. Where there is more than one rear axle shall be verified and recorded in the type approval communication form."

Annex 5, paragraph 3.1.2., amend to read:

- "3.1.2. In the cases defined in paragraphs 1.1.1. and 1.1.2. of this annex a horizontal force of 50 kN or 25 per cent of the force generated by

the maximum mass of the vehicle, whichever is the lesser, shall be applied consecutively to two points located 300 + 25 mm from the longitudinal planes tangential to the outer edges of the wheels on the rear axle **or of the RUPD, if it exceeds the width of the rear axle,** and to a third point located on the line joining these two points, in the median vertical plane of the vehicle."

Annex V

Draft amendments to Regulation No. 61 (paras. 21 and 32)**Supplement 2 to Regulation No. 61**

Add new paragraphs 2.9. and 2.10., to read:

- "2.9. **"Bumper" means the front, lower, outer structure of a vehicle. It includes all structures that are intended to give protection to a vehicle when involved in a low speed frontal collision and also any attachments to this structure.**
- 2.10. **"Bumper cover" means the non-rigid outer surface of a bumper, generally extending across the full width of the front of a vehicle."**

Paragraph 4.1., amend to read:

- "4.1. If the vehicle submitted for approval pursuant to this Regulation meets the requirements of paragraphs 5. and 6. below, approval of that vehicle type shall be granted. **Subject to the acceptance of the Technical Service and to the satisfaction of the Type Approval Authority, a vehicle of category N₁ which is derived from category M₁ may be type approved on the basis of the technical specifications of Regulation No. 26.**"

Paragraph 4.3., amend to read:

- "4.3. Notice of approval or of refusal **or of withdrawal** of approval of a vehicle type pursuant to this Regulation shall be communicated
....."

Paragraph 6.5.2., amend to read:

- "6.5.2. The component of the front protective devices shall be so designed that all rigid surfaces facing outwards have a radius of curvature of not less than 5 mm. **However, if a bumper cover is fitted, it shall have a radius of curvature of not less than 2.5 mm.**"

Paragraphs 7. to 7.2., amend to read:

- "7. MODIFICATION OF VEHICLE TYPE
- 7.1. Every modification to **an existing vehicle type shall be notified to the type approval authority which approved the vehicle type. The type approval authority shall then either:**
- (a) **decide, in consultation with the manufacturer, that a new type-approval is to be granted, or**
 - (b) **apply the procedure contained in paragraph 7.1.1. (Revision) and, if applicable, the procedure contained in paragraph 7.1.2. (Extension).**

7.1.1. **Revision**

When particulars recorded in the information folder have changed and the Type Approval Authority considers that the modifications made are unlikely to have an appreciable adverse effect and that in any case the vehicle still complies with the requirements, the modification shall be designated a "revision".

In such a case, the Type Approval Authority shall issue the revised pages of the information folder as necessary, marking each revised page to show clearly the nature of the modification and the date of re-issue. A consolidated updated version of the information folder, accompanied by a detailed description of the modification, shall be deemed to meet this requirement.

7.1.2. **Extension**

The modification shall be designated an "extension" if, in addition to the change of the particulars recorded in the information folder,

- (a) further inspections or tests are required, or
- (b) any information on the communication document (with the exception of its attachments) has changed, or
- (c) approval to a later series of amendments is requested after its entry into force.

7.2. Confirmation or refusal of approval, specifying the alterations shall be communicated by the procedure specified in paragraph 4.3. above to the Parties to the Agreement which apply this Regulation. **In addition, the index to the information package, attached to the communication document, shall be amended accordingly to show the date of the most recent revision or extension."**

Paragraph 9.2., amend to read:

"9.2. If a Party to the Agreement applying this Regulation withdraws an approval it has previously granted, it shall forthwith so notify the other Contracting Parties applying this Regulation, by means of **communication form conforming to the model in Annex 1 to this Regulation."**

Paragraph 10., amend to read:

"10. **PRODUCTION DEFINITELY DISCONTINUED**

If the holder of the approval completely ceases to manufacture a type of vehicle approved in accordance with this Regulation, he shall so inform the authority which granted the approval. Upon receiving the relevant communication, that authority shall inform thereof the other Parties to the Agreement applying this Regulation by means of a **communication form conforming to the model in Annex 1 to this Regulation."**

Annex 1, amend to read:

"Annex 1

COMMUNICATION
(Maximum format: A4 (210 x 297 mm))



issued by: Name of administration:
.....
.....
.....

concerning: 2/ APPROVAL GRANTED
APPROVAL EXTENDED
APPROVAL REFUSED
APPROVAL WITHDRAWN
PRODUCTION DEFINITELY DISCONTINUED

of a vehicle type with regard its external projections, pursuant to Regulation No. 61

Approval number: Extension number:

- 1. Trade name or mark of the vehicle:
.....
- 9. Approval: granted/**extended**/refused/**withdrawn** 2/
....."

Annex VI

Draft amendments to Regulation No. 67 (para. 23)

Supplement 11 to the 01 series of amendments to Regulation No. 67

Paragraphs 6.15.2.1. and 6.15.2.2., amend to read:

- "6.15.2.1. The electrical connections inside the boot and passengers compartment shall comply with protection degree class IP 40 according to IEC **Standard 60529-1989+A1:1999**.
- 6.15.2.2. All other electrical connections shall comply with protection degree class IP 54 according to IEC **Standard 60529-1989+A1:1999**."

Paragraph 6.15.13.1.1., amend to read:

- "6.15.13.1.1. In case the shall comply with **protection degree** class IP 40 according to IEC **Standard 60529-1989+A1:1999**."

Paragraph 17.11.4., amend to read:

- "17.11.4. Electrical cables shall be shall comply with **protection degree** class IP 40 according to IEC **Standard 60529-1989+A1:1999**. All other electrical connections shall comply with **protection degree** class IP 54 according to IEC **Standard 60529-1989+A1:1999**."

Annex 8,

Insert new paragraphs 4.4.2.1. to 4.4.2.3., to read:

- "4.4.2.1. The test shall be performed in compliance with standard ISO 1431/1-1:2004/Amd 1:2009.
- 4.4.2.2. The test-pieces, which have to be stretched to an elongation of 20 per cent shall be exposed to air of 40 °C and a relative humidity of 50 per cent ± 10 per cent with an ozone concentration of 50 parts per hundred million during 120 hours.
- 4.4.2.3. Cracking of the test pieces is not allowed."

Paragraphs 4.4.3.3.1., 4.4.3.3.2. and 4.4.3.3.3., should be deleted.

Annex 10,

Paragraph 2.1.2.3.1., amend to read:

- "2.1.2.3.1. The bend test shall be carried out in accordance with standards ISO 7438:2005 and ISO 7799:1985 and **ISO 5173:2009 + Amd 1:2011** for welded parts. The bend tests shall be carried out on the inner surface in tension and the outer surface in tension.

Annex VII

Draft amendments to Regulation No. 110 (para. 24)

Adopted amendments to ECE/TRANS/WP.29/GRSG/2012/9

The proposed amendments to Annex 3, Appendix A.15.5., should be removed.

Insert new paragraphs 23. to 23.6., to read:

- "23. TRANSITIONAL PROVISIONS
- 23.1. As from the official date of entry into force of the 01 series of amendments to this Regulation, no Contracting Party applying this Regulation shall refuse to grant or refuse to accept type approval under this Regulation as amended by the 01 series of amendments.
- 23.2. As from 12 months after the date of entry into force of the 01 series of amendments to this Regulation, Contracting Parties applying this Regulation shall grant approvals only if the type of components to be approved meets the requirements of Part I of this Regulation as amended by the 01 series of amendments to this Regulation.
- 23.3. As from 18 months after the date of entry into force of the 01 series of amendments to this Regulation, Contracting Parties applying this Regulation shall grant approvals only if the vehicle type to be approved meets the requirements of Part II of this Regulation as amended by the 01 series of amendments to this Regulation.
- 23.4. Until 12 months after the date of entry into force of the 01 series of amendments to this Regulation, Contracting Parties applying this Regulation can continue to grant type-approvals for the type of components to the original version of this Regulation without taking into account the provisions of the 01 series of amendments.
- 23.5. Until 18 months after the date of entry into force of the 01 series of amendments to this Regulation, Contracting Parties applying this Regulation can continue to grant type-approvals for the vehicle type to the original version of this Regulation without taking into account the provisions of the 01 series of amendments.
- 23.6. Notwithstanding the provisions of paragraphs 23.4. and 23.5., Contracting Parties applying this Regulation shall not refuse to grant extensions of type-approvals for existing types of component or vehicle types which have been issued according to this Regulation without taking into account the provisions of the 01 series of amendments to this Regulation."

Annex 2A, the figure and the text below the figure, amend to read:

"

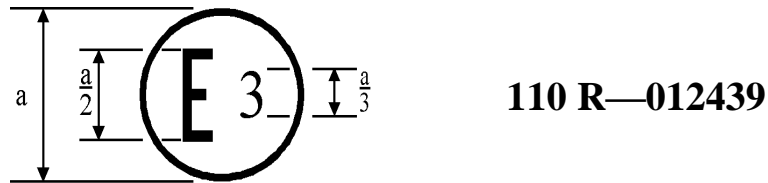

$a \geq 8 \text{ mm}$

The above approval mark affixed to the CNG component shows that this component has been approved in Italy (E3), pursuant to Regulation No. 110 under approval number **012439**. The first two digits of the approval number indicate that the approval was granted in accordance with the requirements of Regulation No. 110 **as amended by the 01 series of amendments.**"

Annex 2C, models A and B, the figure and the text below the figure, amend to read:

"Model A

(See paragraph 16.2. of this Regulation)

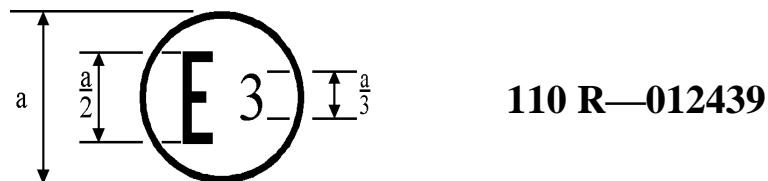

$a \geq 8 \text{ mm}$

The above approval mark affixed to a vehicle shows that the vehicle has, with regard to the installation of CNG system for the use of CNG for propulsion, been approved in Italy (E3), pursuant to Regulation No. 110 under approval number **012439**. The first two digits of the approval number indicate that the approval was granted in accordance with the requirements of Regulation No. 110 **as amended by the 01 series of amendments.**

Model B
(See paragraph 16.2. of this Regulation)

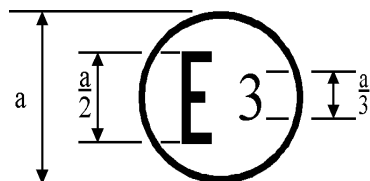

110 012439

83 051628

$a \geq 8 \text{ mm}$

The above approval mark affixed to a vehicle shows that the vehicle has, with regard to the installation of CNG system for the use of CNG for propulsion, been approved in Italy (E3), pursuant to Regulation No. 110 under approval number **012439**. The first two digits of the approval number indicate that at the date the approval was granted in accordance with the requirements of Regulation No. 110 **as amended by the 01 series of amendments** and that Regulation No. 83 included the **05** series of amendments."

Annex VIII

Draft amendments to Regulation No. 121 (para. 26)





Supplement 8 to Regulation No. 121

Insert a new paragraph 5.2.10., to read:

"5.2.10. Automatic functions may be indicated with the symbol relevant for the corresponding item as referred to in Column 1 of Table 1, with the supplementary letter(s) "A" or "AUTO" positioned on or adjacent to its outline."

Table 1, amend to read (including the deletion of footnote 20/):

"

No.	Column 1	Column 2	Column 3	Column 4	Column 5
	Item	Symbol <u>2/</u>	Function	Illumination	Colour
...
3b	Automatic main beam functions	 or  <u>1/, 6/, 13/</u>	Control	No	-
			Tell-tale	Yes	-
...
25.	Brake system malfunction	 <u>8/</u>	Tell-tale	Yes	See Regulation Nos. 13-H and 13 as appropriate
...
28.	Parking brake	 <u>9/</u>	Tell-tale	Yes	See Regulation Nos. 13-H and 13 as appropriate
...

..."

Annex IX

Draft amendments to Regulation No. 125 (para. 28)

01 Series of amendments to Regulation No. 125

The table of contents, amend to read:

"Regulation

1. Scope

...

11. Names and addresses of Technical Services responsible for conducting approval tests, and of **Type Approval Authority**

12. Transitional Provisions"

Paragraph 4.2., amend to read:

"4.2. An approval number shall be assigned to each type approved. Its first two digits (**at present 01** for the Regulation in its **current** form) shall indicate the series of amendments incorporating"

Insert a new paragraph 5.1.4., including new figures 1 and 2, to read:

"5.1.4. In the case where the height of V2 above the ground exceeds 1,650 mm, the following requirement shall be met:

A 1,200 mm tall cylindrical object with a diameter of 300 mm that is situated inside the space bounded by a vertical plane located 2,000 mm in front of the vehicle, a vertical plane located 2,300 mm in front of the vehicle, a vertical plane located 400 mm from the driver's side of the vehicle, and a vertical plane located 600 mm from the opposite side of the vehicle shall be at least partially visible when viewed directly from V2 (see figure 1), regardless of where the object is within that space, unless it is invisible due to a blind spot(s) created by the A pillars, windscreen wipers, or steering wheel.

If the driver's seat is located in the central driving position of the vehicle, the 1,200 mm tall cylindrical object shall be situated inside the space bounded by a vertical plane located 2,000 mm in front of the vehicle, a vertical plane located 2,300 mm in front of the vehicle, a vertical plane located 500 mm from the side of the vehicle (see figure 2).

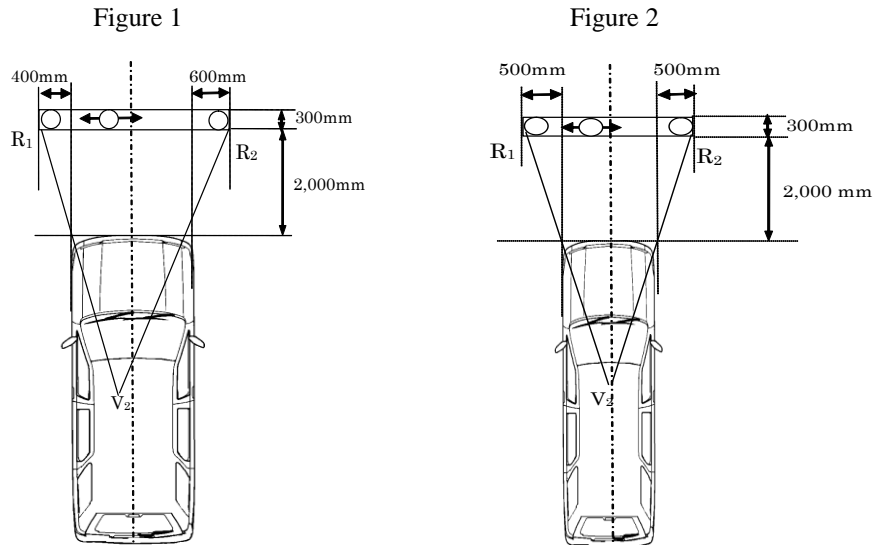

"

Insert new paragraphs 12.1. to 12.5., to read:

- "12. Transitional Provisions
- 12.1. As from the official date of entry into force of the 01 series of amendments, no Contracting Party applying this Regulation shall refuse to grant approval under this Regulation as amended by the 01 series of amendments.
- 12.2. As from 24 months after the date of entry into force of the 01 series of amendments to this Regulation, Contracting Parties applying this Regulation shall grant approvals only if the vehicle type to be approved meets the requirements of this Regulation as amended by the 01 series of amendments.
- 12.3. Contracting Parties applying this Regulation shall not refuse to grant extensions of approvals for existing types which have been granted according to the original version of this Regulation.
- 12.4. Even after the entry into force of the 01 series of amendments to this Regulation, type approvals of the vehicles to the original version of this Regulation shall remain valid. Contracting Parties applying this Regulation shall continue to accept them.
- 12.5. Notwithstanding the transitional provisions above, Contracting Parties whose application of this Regulation comes into force after the date of entry into force of the 01 series of amendments are not obliged to accept approvals which were granted in accordance with the original version of this Regulation."

Annex 2, amend to read:

"Annex 2

Arrangements of approval marks

See paragraphs 4.4. to 4.4.2. of this Regulation

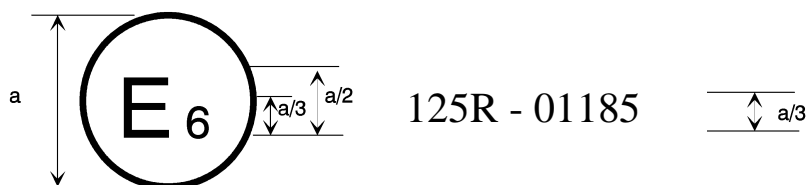

$a = 8 \text{ mm min}$

The above approval mark affixed to a vehicle shows that the vehicle type concerned has been approved in Belgium (E6) with regard to the driver's forward field of vision pursuant to Regulation No. 125. The first two digits of the approval number indicate that the approval was granted in accordance with the requirements of Regulation No. 125 **as amended by the 01 series of amendments.**"

Annex X

Draft amendments to Regulation Nos. 97 and 116 (para. 29)

Supplement 7 to the 01 series of amendments to Regulation No. 97

Annex 9, paragraph 1., amend to read:

"1. Method ISO

.....

Immunity against radiated high frequency disturbances

Testing of the immunity of a VAS/AS in a vehicle may be performed according to **the technical prescriptions and transitional provisions of** Regulation No. 10, **04 series** of amendments and test methods described in Annex 6 for the vehicles and Annex 9 for a separate technical unit.

.....

Radiated emissions

Tests shall be performed according to **the technical prescriptions and transitional provisions of** Regulation No. 10, **04 series** of amendments and according to the test methods described in Annexes 4 and 5 for vehicles or Annexes 7 and 8 for a separate technical unit."

Annex 9, paragraph 2., amend to read:

"2. Method IEC

.....

Radiated emissions

The VAS/AS shall be subjected to testing for the suppression of radio frequency interference according to **the technical prescriptions and transitional provisions of** Regulation No. 10, **04 series** of amendments and according to test methods described in Annexes 4 and 5 for vehicles and Annexes 7 and 8 for a separate technical unit."

Supplement 4 to Regulation No. 116

Annex 9, paragraph 1., amend to read:

"1. Method ISO

.....

Immunity against radiated high frequency disturbances

Testing of the immunity of a VAS/AS in a vehicle may be performed according to **the technical prescriptions and transitional provisions of** Regulation No. 10, **04 series** of amendments and test methods described in Annex 6 for the vehicles and Annex 9 for a separate technical unit.

.....

Radiated emissions

Tests shall be performed according to **the technical prescriptions and transitional provisions of** Regulation No. 10, **04 series** of amendments and according to the test methods described in Annexes 4 and 5 for vehicles or Annexes 7 and 8 for a separate technical unit."

Annex 9, paragraph 2., amend to read:

"2. Method IEC

.....

Radiated emissions

The VAS/AS shall be subjected to testing for the suppression of radio frequency interference according to **the technical prescriptions and transitional provisions of** Regulation No. 10, **04 series** of amendments and according to test methods described in Annexes 4 and 5 for vehicles and Annexes 7 and 8 for a separate technical unit."

Annex XI

GRSG informal groups

<i>Informal group</i>	<i>Chairperson</i>	<i>Secretary</i>
Camera Monitor Systems (CMS)	Mr. H. Jongenelen (Netherlands) Tel: +31 79 3458268 Fax : +31 793458041 Email : hjongenelen@rdw.nl	
Service Doors, Windows and Emergency Exits in Buses and coaches (SDWEE)	Mr. J. Kownacki (Poland) Tel:+48 22 8112510 Fax : +48 22 8114062 Email : jerzy.kownacki@its.waw.pl	Mr. O. Fontaine (OICA) Tel: +33 1-43590013 Fax : +33 1-45638441 Email: ofontaine@oica.net
Plastic glazing	Mr. K. Preusser (Germany) Tel: +49 230443623 Fax : +49 2304467544 Email : dr.klaus.preusser@t-online.de	Mr. O. Fontaine (OICA) Tel: +33 1-43590013 Fax : +33 1-45638441 Email: ofontaine@oica.net
GTR on motorcycle controls, tell-tales and indicators	Mr. A. Erario (Italy) Tel: +39 06 4158 6228 Fax: +39 06 4158 3253 E-mail: antonio.erario@mit.gov.it	Mr. R. Choda (IMMA) Tel: +41 22 920 21 20 Fax: +41 22 920 21 21 E-mail: ravchoda@immamotorcycles.org