



Economic and Social Council

Distr.: General
12 July 2023

Original: English

Economic Commission for Europe

Inland Transport Committee

Global Forum for Road Traffic Safety

Eighty-seventh session

Geneva, 25-29 September 2023

Item 7 of the provisional agenda

Convention on Road Signs and Signals (1968)

Amendment proposals to the 1968 Convention on Road Signs and Signals

Submitted by Lithuania and Luxembourg

This document contains the text of the 1968 Convention on Road Signs and Signals with proposed amendments identified as additions (in bold) and deletions (in strikethrough). It originates in the final report of the Group of Experts on Road Signs and Signals (ECE/TRANS/WP.1/2019/4) and amendment proposals to Annex 1 and 3 (ECE/TRANS/WP.1/2019/5) and their respective revised versions Rev.1 and Rev.2 as well as related Informal documents Nos. 2, 4, and 5 (September 2022) and No. 5 (March 2023). The related amendment proposals to the European Agreement Supplementing the 1968 Convention on Road Signs and Signals and the Protocol on Road markings (additional to the European Agreement) can be found in ECE/TRANS/WP.1/2023/3 and ECE/TRANS/WP.1/2023/4 respectively. Additional information on the amendments to the “European Supplement” and “protocol on Road markings” can be found in Informal documents Nos. 10 and 11 (March 2023).

The final report of the Group of Experts on Road Signs and Signals ECE/TRANS/WP.1/2019/4, Rev.1 and Rev.2 provide detailed explanation on the proposed changes.

CONVENTION ON ROAD SIGNS AND SIGNALS

The Contracting Parties,

Recognizing that international uniformity of road signs, signals and symbols and of road markings is necessary in order to facilitate international road traffic and to increase road safety,

Have agreed upon the following provisions:

Chapter I

GENERAL PROVISIONS

ARTICLE 1

Definitions

For the purpose of this Convention, the following expressions shall have the meanings hereby assigned to them:

(a) The "domestic legislation" of a Contracting Party means the entire body of national or local laws and regulations in force in the territory of that Contracting Party;

(b) "Built-up area" means an area with entries and exits specially ~~sign-posted~~ **signposted** as such, or otherwise defined in domestic legislation;

(b bis) "Residential area" means a specially-designed area where special traffic rules apply and which is signposted as such at its entries and exits;

(c) "Road" means the entire surface of any way or street open to public traffic;

(d) "Carriageway" means the part of a road normally used by vehicular traffic; a road may comprise several carriageways clearly separated from one another by, for example, a dividing strip or a difference of level;

~~(e) bis.~~ **(e bis)** "Cycle lane" means a part of a carriageway designated for cycles. A cycle lane is distinguished from the rest of the carriageway by longitudinal road markings.

~~(e) ter.~~ **(e ter)** "Cycle track" means an independent road or part of a road designated for cycles, signposted as such. A cycle track is separated from other roads or other parts of the same road by structural means.

(f) "Intersection" means any level crossroad, junction or fork, including the open areas formed by such crossroads, junctions or forks;

(g) ~~"Level crossing"~~ **Level crossing** means any level intersection between a road and a railway or tramway track with its own track formation;

(h) "Motorway" means a road specially designed and built for motor traffic, which does not serve properties bordering on it, and which:

(i) Is provided, except at special points or temporarily, with separate carriageways for the two directions of traffic, separated from each other either by a dividing strip not intended for traffic or, exceptionally, by other means;

(ii) Does not cross at level with any road, railway or tramway track, or footpath; and,

(iii) Is specially ~~sign-posted~~ **signposted** as a motorway;

(i) A vehicle is said to be:

(i) "Standing" if it is stationary for the time needed to pick up or set down persons or to load or unload goods; and

(ii) "Parked" if it is stationary for any reason other than the need to avoid interference with another ~~road user~~ **road user** or collision with an obstruction or to comply with traffic regulations, and if the period during which the vehicle is stationary is not limited to the time needed to pick up or set down persons or goods;

Nevertheless, it shall be open to Contracting Parties to regard as "standing" any vehicle which is stationary within the meaning of subparagraph (ii) above for a period not exceeding that fixed by domestic legislation, and to regard as "parked" any vehicle which is stationary within the meaning of subparagraph (i) above for a period exceeding that fixed by domestic legislation;

(j) "Cycle" means any vehicle which has at least two wheels and is propelled solely by the muscular energy of the persons on that vehicle, in particular by means of pedals or hand-cranks;

(k) "Moped" means any two-wheeled or three-wheeled vehicle which is fitted with an internal combustion engine having a cylinder capacity not exceeding 50 cc and a maximum design speed not exceeding 50 km (30 miles) per hour. Contracting Parties are free, however, not to regard as mopeds, under their domestic legislation, vehicles which do not have the characteristics of a cycle with respect to their use, in particular the characteristic that they can be propelled by pedals, or whose maximum design speed, whose ~~mass~~ **mass**, or certain of whose engine characteristics exceed certain limits. Nothing in this definition shall be construed as preventing Contracting Parties from treating mopeds exactly as cycles in applying the provisions of their domestic legislation regarding road traffic;

(l) "Motor cycle" means any two-wheeled vehicle, with or without a side-car, which is equipped with a propelling engine. Contracting Parties may also treat as motor cycles in their domestic legislation three-wheeled vehicles whose unladen ~~mass~~ **mass** does not exceed 400 kg. The term "motor cycle" does not include mopeds, although Contracting Parties may, provided they make a declaration to this effect in conformity with Article 46, paragraph 2, of this Convention, treat mopeds as motor cycles for the purposes of the Convention;

(m) "Power-driven vehicle" means any self-propelled road vehicle, other than a moped in the territories of Contracting Parties which do not treat mopeds as motor cycles, and other than a rail-borne vehicle;

(n) "Motor vehicle" means any power-driven vehicle which is normally used for carrying persons or goods by road or for drawing on the road, vehicles used for the carriage of persons or goods. This term embraces trolley-buses, that is to say, vehicles connected to an electric conductor and not rail-borne. It does not cover vehicles, such as agricultural tractors, which are only incidentally used for carrying persons or goods by road or for drawing, on the road, vehicles used for the carriage of persons or goods;

(o) "Trailer" means any vehicle designed to be drawn by a power-driven vehicle and includes semi-trailers;

(p) "Semi-trailer" means any trailer designed to be coupled to a motor vehicle in such a way that part of it rests on the motor vehicle and that a substantial part of its ~~mass~~ **mass** and of the ~~mass~~ **mass** of its load is borne by the motor vehicle;

(q) "Driver" means any person who drives a motor vehicle or other vehicle (including a cycle), or who guides cattle, singly or in herds, or flocks or draught, pack or saddle animals on a road;

(r) "Permissible maximum ~~mass~~**mass**" means the maximum ~~mass~~**mass** of the laden vehicle declared permissible by the competent authority of the State in which the vehicle is registered;

(s) "Laden ~~mass~~**mass**" means the actual mass~~mass~~ of the vehicle as loaded, with the crew and passengers on board;

(t) "Direction of traffic" and "appropriate to the direction of traffic" mean the right-hand side if, under domestic legislation, the driver of a vehicle must allow an oncoming vehicle to pass on his left; otherwise these expressions mean the left-hand side;

(u) The requirement that a driver shall "give way" to other vehicles means that he must not continue or resume his advance or manoeuvre if by so doing he might compel the drivers of other vehicles to change the direction or speed of their vehicles abruptly.

ARTICLE 2

Annexes to the Convention

~~The annexes to this Convention, namely:~~

Annex 1: Road signs;

Section A: Danger warning signs;

Section B: Priority signs;

Section C: Prohibitory ~~or~~**and** restrictive signs;

Section D: Mandatory signs;

Section E: Special regulation signs;

Section F: Information, facilities or service signs;

Section G: ~~Direction, position or indication signs;~~ **Other information signs;**

Section H: Additional panels;

Annex 2: Road markings;

~~Annex 3: Reproduction in colour of signs, symbols and panels referred to in Annex 1;~~ **and Annex 2** are integral parts of this Convention.

ARTICLE 3

Obligations of the Contracting Parties

1. (a) The Contracting Parties to this Convention accept the system of road signs, signals and symbols and road markings described herein and undertake to adopt it as soon as possible. To this end,

(i) Where this Convention prescribes a sign, symbol or marking for signifying a certain rule or conveying certain information to ~~road users~~**road users**, the Contracting Parties undertake, subject to the time-limits specified in paragraphs 2 and 3 of this Article, not to use any other sign, symbol or marking for signifying that rule or conveying that information;

(ii) Where this Convention does not prescribe a sign, symbol or marking for signifying a certain rule or conveying certain information to ~~road users~~**road users**, it shall be open to the Contracting Parties to use for these purposes any sign, symbol or marking they wish, provided that such sign, symbol or marking is not assigned a different meaning in this Convention and provided that it conforms to the system prescribed by this Convention.

(b) With a view to improving traffic control techniques, and having regard to the usefulness of carrying out experiments before proposing amendments to this Convention, it shall be open to Contracting Parties to derogate from the provisions of this Convention, for experimental purposes and temporarily, on certain sections of road.

2. Contracting Parties undertake to replace or supplement, not later than four years from the date of entry into force of this Convention in their territories, any sign, symbol, installation or marking which, although it has the characteristics of a sign, symbol, installation or marking belonging to the system prescribed by this Convention, is used with a different meaning from that assigned to it in this Convention.

3. Contracting Parties undertake to replace, within 15 years from the date of entry into force of this Convention in their territories, any sign, symbol, installation or marking which does not conform to the system prescribed in this Convention. During this period, in order to familiarize ~~road users~~ **road users** with the system prescribed in this Convention, previous signs and symbols may be retained beside those prescribed in this Convention.

4. Nothing in this Convention may be construed as requiring the Contracting Parties to adopt all the types of sign and marking prescribed in this Convention. On the contrary, Contracting Parties shall limit the number of types of sign or marking they adopt to what is strictly necessary.

ARTICLE 4

The Contracting Parties undertake that it shall be prohibited:

(a) To affix to a sign, to its support or to any other traffic control device anything not related to the purpose of such sign or device; if, however, Contracting Parties or sub-divisions thereof authorize a non-profit-making association to install informative signs, they may permit the emblem of that association to appear on the sign or on its support provided this does not make it less easy to understand the sign;

(b) To install any board, notice, marking or device which might be confused with signs or other traffic control devices, might render them less visible or effective, or might dazzle ~~road users~~ **road users** or distract their attention in a way prejudicial to traffic safety.

Chapter II

ROAD SIGNS

ARTICLE 5

1. The system prescribed in this Convention differentiates between the following classes of road signs:

(a) Danger warning signs: these signs are intended to warn ~~road users~~ **road users** of a danger on the road and to inform them of its nature;

(b) Regulatory signs: these signs are intended to inform ~~road users~~ **road users** of special obligations, restrictions or prohibitions with which they must comply; they are subdivided into:

- (i) Priority signs;
- (ii) Prohibitory ~~or~~ **and** restrictive signs;
- (iii) Mandatory signs;
- (iv) Special regulation signs;

(c) Informative signs: these signs are intended to guide ~~road users~~**road users** while they are travelling or to provide them with other information which may be useful; they are subdivided into:

- (i) Information, facilities or service signs;
- (ii) ~~Direction, position or indication signs;~~**Other information signs:**

Advance direction signs;

Direction signs;

Road identification signs;

Place identification signs;

Confirmatory signs;

Indication signs;

~~(iii) Additional panels.~~

(d) Additional panels: these signs, only used with other signs, provide additional information.

2. Where this Convention allows a choice between several signs, ~~or~~ several symbols, **or several colours,**

(a) Contracting Parties undertake to adopt only one of such signs or symbols for the whole of their territories **and only one of such colours for the permanent signs of Annex 1, section A and Annex 1, section C and the relevant permanent signs of Annex 1, section B for the whole of their territories and only one of such colours for the temporary signs for the whole of their territories;**

(b) Contracting Parties shall endeavour to reach regional agreements on the same choice;

(c) The provisions of Article 3, paragraph 3, of this Convention shall apply to signs and symbols of the types which are not chosen.

ARTICLE 6

1. Signs shall be so placed that the drivers for whom they are intended can recognize them easily and in time. They shall normally be placed on the side of the road appropriate to the direction of traffic; they may, however, be placed or repeated above the carriageway. Any sign placed on the side of the road appropriate to the direction of traffic shall be repeated above or on the other side of the carriageway if local conditions are such that it might not be seen in time by the drivers for whom it is intended.

2. All signs shall apply to the drivers ~~from~~**for** whom they are intended over the whole width of the carriageway open to traffic. However, signs may be made to apply to only one or to several lanes of the carriageway when lanes are defined by longitudinal markings.

In this case, one of the following three options shall be used:

(a) The sign with, if necessary, the addition of a vertical arrow shall be placed above the lane concerned, or

(b) The sign will be placed on the nearside edge of the carriageway when the road markings indicate without doubt that the sign applies solely to the traffic lane on the nearside of the carriageway and that the only purpose of this sign is to confirm a local regulation already indicated by means of road markings, or

(c) Signs ~~E, 1 or E, 2~~ described in Annex 1, section E, subsection II, paragraphs 1 (**REGULATION OR DANGER WARNING APPLYING TO A LANE**) and 2 (**LANE RESERVED FOR BUSES and LANE RESERVED FOR OTHER CATEGORIES OF VEHICLES**) to this Convention or signs ~~G, 11 and G, 12~~ described in Annex 1, section G, subsection ~~VII~~, paragraphs ~~1 and 2~~ **6 A (DIRECTION OF LANES) and B (END OR CLOSURE OF A LANE)** will be placed on the edge of the carriageway.

3. Where in the opinion of competent authorities a sign would be ineffective if placed on the verge of a road with separated carriageways, it may be placed on the dividing strip and in this case need not be repeated on the verge.

4. It is recommended that domestic legislation should provide:

(a) That signs shall be so placed that they do not obstruct vehicular traffic on the carriageway, and, if placed on the verges, obstruct pedestrians as little as possible. The difference in level between the carriageway on the side where a sign is placed and the lower edge of the sign shall be as uniform as possible for signs of the same class on the same route;

(b) That the dimensions of sign panels shall be such that the sign is easily visible for a distance and can be easily understood by a person approaching it; subject to the provisions of subparagraph (c) of this paragraph, these dimensions shall be adapted to the normal speed of vehicles;

(c) That the dimensions of danger warning signs and of regulatory signs (except special regulation signs) shall be standardized in the territory of each Contracting Party.

As a general rule, there shall be four sizes for each type of sign: small, normal, large and very large. Small signs shall be used where conditions do not permit the use of normal signs or where traffic can only move slowly; they may also be used to repeat a preceding sign. Large signs shall be used on very wide roads carrying high-speed traffic. Very large signs shall be used on roads carrying very high-speed traffic, such as motorways.

ARTICLE 7

1. It is recommended that domestic legislation provide that, in order to make them more visible and legible at night, road signs, in particular danger warning signs, regulatory signs and direction signs shall be lighted or retroreflective, provided that this does not result in road users being dazzled.

2. Contracting Parties may also allow the use of fluorescent materials; in this case they shall define which signs may make use of these materials.

3. Domestic legislation should draw up rules for the use of lighted, retroreflective and fluorescent signs. It should also specify the situations in which each class of retroreflective materials shall be used.

4. Dark or light graphic elements of different colours in the signs ~~may~~ **should preferably** be differentiated by means of contrasting ~~light or dark white or yellow and black or dark blue~~-narrow strips respectively.

4 bis. White or yellow and black or dark blue rims may be used at the edge to enhance conspicuity of signs. For additional panels, it is possible to replace a black or a dark blue rim with a red rim.

5. Nothing in this Convention shall prohibit the use, for conveying information, warnings or rules applying only at certain times or on certain days, of signs which are visible only when the information they convey is relevant.

ARTICLE 8

1. In order to facilitate international understanding of signs, the system of signs and signals prescribed in this Convention is based on the use of shapes, and colours characteristic of each class of sign and, wherever possible, on the use of graphic symbols rather than inscriptions. Where Contracting Parties consider it necessary to modify the symbols prescribed, the modifications made shall not alter their essential characteristics.

~~4-bis.~~ **1 bis.** In cases where variable message signs are used, the inscriptions and symbols reproduced on them must also conform to the system of signs and signals prescribed in this Convention. When, however, the technical requirements of a given type of system of signs and signals so warrant, particularly so as to ensure satisfactory legibility, and provided that no error of interpretation is possible, the prescribed dark-coloured signs or symbols may appear in a light colour, light-coloured backgrounds then being replaced by dark backgrounds. The red colour of the symbol of a sign and its border shall not be changed.

2. Contracting Parties wishing to adopt, in accordance with Article 3, paragraph 1 (a) (ii), of this Convention, any sign or symbol not prescribed in this Convention shall endeavour to secure regional agreement on such new sign or symbol.

3. Nothing in this Convention shall prohibit the addition, ~~mainly~~ in order to facilitate the interpretation of signs, of an inscription in ~~a rectangular~~ **an additional** panel ~~below the sign or in a rectangular panel containing the sign;~~ such an inscription may also be placed on the sign itself, if this does not make the sign more difficult to understand for drivers who cannot understand the inscription.

4. Where the competent authorities consider it advisable to make the meaning of a sign or symbol more explicit or to limit the application of a sign to certain periods, this can be done by inscriptions on the sign as provided in Annex 1 to this Convention or on an additional panel. If regulatory signs are to be restricted to ~~certain road users~~ **road users** or if certain ~~road users~~ **road users** are to be exempt from the regulation, this is done through additional panels according to Annex 1, section H, **subsection II**, paragraph **4 3 (ROAD USER PANEL)** and **4 (PERSON WITH DISABILITIES PANEL)** (~~panels H, 5a; H, 5b; and H, 6~~).

5. The inscriptions referred to in paragraphs 3 and 4 of this Article shall be in the national language or in one or more of the national languages, and also, if the Contracting Party concerned considers it advisable, in other languages, in particular official languages of the United Nations.

DANGER WARNING SIGNS

ARTICLE 9

1. Section A, ~~subsection I~~ of Annex 1 to this Convention ~~indicates~~ **provides** the models for danger warning signs; **describes the danger warning signs and gives their meaning.** Section A, subsection II indicates the symbols to be placed on these signs and gives some instructions for their use. In conformity with Article 46, paragraph 2 of this Convention, each State shall notify the Secretary-General whether it has selected ~~A^a or A^b as the model~~ **for one (equilateral triangle) or model two (square with one diagonal vertical)** for danger warning signs.

2. The number of danger warning signs shall not be increased unnecessarily, but such signs shall be sited to give warning of possible road hazards which are difficult for a driver proceeding with due caution to perceive in time.

3. Danger warning signs shall be placed at such distance from the danger point as will make them most effective both by day and by night, having regard to road and traffic conditions, including the normal speed of vehicles and the distance at which the sign is visible.

4. The distance between the sign and the beginning of a dangerous section of road ~~may be shown in an additional panel H, 1 of Annex 1, section H to this Convention and placed in accordance with the provisions of that section; this information must~~ **shall** be given when the distance between the sign and the beginning of the dangerous section of road cannot be judged by drivers ~~and or~~ is not what they might normally expect. **This distance shall be shown in accordance with Annex 1, section H, subsection II, paragraph 1 (DISTANCE PANEL).**

5. Danger warning signs may be repeated, particularly on motorways and roads treated as motorways. Where they are repeated, the distance between the sign and the beginning of the dangerous section of road shall be shown in accordance with the provisions of paragraph 4 of this Article.

However, with respect to danger warning signs giving warning of **and distance to swing bridges and level crossings and opening bridges**, ~~it shall be open to Contracting Parties may to apply the following provisions: A use signs specific for approaches to level crossings and opening bridges, which are described~~ **rectangular panel having its longer sides vertical and bearing three oblique red bars on a white or yellow ground may be placed below any danger warning sign bearing one of the symbols A, 5; A, 25; A, 26 or A, 27 described in Annex 1, section A, subsection II, paragraphs 5, 25, 26 and 27 to this Convention, provided that additional signs consisting of panels of the same shape bearing respectively one or two oblique red bars on a white or yellow ground are set up at about one third and two thirds of the distance between the sign and the railway line. These signs may be repeated on the opposite side of the carriageway. The panels mentioned in this paragraph are further depicted in Annex 1, section A, subsection II, paragraph 2927 of Annex 1 to this Convention (APPROACHES TO LEVEL CROSSINGS OR OPENING BRIDGES).**

6. If a danger warning sign is used to give warning of a danger on a section of road of some length (e.g. a series of dangerous bends or a section of carriageway in bad condition) and if it is considered desirable to show the length of that section, this shall be done **in accordance with** ~~on an additional panel H, 2 of Annex 1, section H, subsection II, paragraph 1 (LENGTH INDICATION PANEL) to this Convention, placed in accordance with the provisions of that section.~~

REGULATORY SIGNS

ARTICLE 10

Priority signs

1. The signs for notifying or informing ~~road users~~ **road users** of the special rules of priority at intersections are ~~signs B, 1; B, 2; B, 3 and B, 4. described in Annex 1, section B, paragraphs 1 to 4. The signs for informing road users of a rule of priority on narrow sections of road are signs B, 5 and B, 6. These signs are described in Annex 1, section B to this Convention.~~

2. ~~Sign B, 1 "GIVE WAY", shall be used to notify drivers that, at the intersection where the sign is placed, they must give way to vehicles on the road they are approaching.~~

2. **The signs described in Annex 1, section B, paragraphs 1 (GIVE WAY) and 2 (STOP) shall be placed at the intersection, if possible level with the point at which vehicles must stop or beyond which they must not**

pass when giving way. They may be placed elsewhere than at an intersection if the competent authorities consider it necessary. The STOP sign shall be set up only if the competent authorities consider it advisable to require drivers to stop, in particular because of the poor visibility, for drivers, of the sections of the road, on either side of the intersection, which they are approaching.

~~3. — Sign B, 2, "STOP", shall be used to notify drivers that, at the intersection where the sign is placed, they shall stop before entering the intersection and give way to vehicles on the road they are approaching. In conformity with Article 46, paragraph 2, of this Convention, each State shall notify the Secretary-General whether it has selected B, 2^a or B, 2^b as the model for the "STOP" sign.~~

3. The sign described in Annex 1, section B, paragraph 3 (PRIORITY ROAD) may be placed at the beginning of the road and repeated after each intersection; it may also be set up before or at the intersection.

~~4. — Sign B, 1 or B, 2 may be placed elsewhere than at an intersection if the competent authorities consider it necessary.~~

4. The sign described in Annex 1, section B, paragraph 4 (END OF PRIORITY) shall be placed at the approach to the point from where the sign of Annex 1, section B, paragraph 3 (PRIORITY ROAD) ceases to apply.

~~5. — Signs B, 1 and B, 2 shall be placed at the intersection, if possible level with the point at which vehicles must stop or beyond which they must not pass when giving way.~~

5. The sign of Annex 1, section B, paragraph 4 (END OF PRIORITY) may be repeated one or more times in advance of the point where the priority ends; the sign or signs set up in advance of that point shall be placed together with an additional panel described in Annex 1, section H, paragraph 1 (DISTANCE PANEL).

~~6. — To give advance warning of sign B, 1 the same sign supplemented by an additional panel H, 1, described in Annex 1, section H to the Convention, shall be used. To give advance warning of sign B, 2, sign B, 1, supplemented by a rectangular panel bearing the "STOP" symbol and a figure indicating the distance to the sign B, 2 shall be used.~~

6. If warning of an intersection is given on a priority road by danger warning signs described in Annex 1, section A, subsection II, paragraph 19 (INTERSECTION WITH A GIVE WAY ROAD), or if at the intersection the road is a priority road and has been signposted as such by the sign described in Annex 1, section B, paragraph 3 (PRIORITY ROAD), the signs described in Annex 1, section B, paragraphs 1 (GIVE WAY) and 2 (STOP) shall be placed at the intersection on all the other roads; however, the placing of those signs shall not be mandatory on roads such as paths or earth-tracks where drivers are required to give way at the intersection even in the absence of such signs.

~~7. — Sign B, 3, "PRIORITY ROAD", shall be used to notify users of a road that, at intersections of that road with other roads, the drivers of vehicles moving along or coming from such other roads are required to give way to vehicles moving along that road. This sign may be set up at the beginning of the road and repeated after each intersection; it may also be set up before or at the intersection. Where sign B, 3 has been set up on a road, sign B, 4, "END OF PRIORITY", shall be placed at the approach to the point where the road ceases to have priority over other roads.~~

Sign B, 4 may be repeated one or more times in advance of the point where the priority ends; the sign or signs set up in advance of that point shall then bear an additional panel H, 1 of Annex 1, section H.

7. The signs for informing road users of a rule of priority on narrow sections of road are described in Annex 1, section B, paragraphs 5 (PRIORITY FOR ONCOMING TRAFFIC) and 6 (PRIORITY OVER ONCOMING TRAFFIC).

~~8. — If warning of an intersection is given on a road by a danger warning sign bearing one of the A, 19 symbols, or if at the intersection the road is a priority road and has been marked as such by signs B, 3 as provided in paragraph 7 of this Article, a sign B, 1 or B, 2 shall be placed at the intersection on all the other roads; however, the placing of signs B, 1 or B, 2 shall not be mandatory on roads such as paths or earth tracks where drivers are required to give way at the intersection even in the absence of such signs.~~

~~A sign B, 2 shall be set up only if the competent authorities consider it advisable to require drivers to stop, in particular because of the poor visibility, for drivers, of the sections of the road, on either side of the intersection, which they are approaching.~~

ARTICLE 11

Prohibitory ~~or~~ and restrictive signs

Section C of Annex 1 to this Convention describes the prohibitory and restrictive signs and gives their meaning. It also describes the signs notifying the end of these prohibitions and restrictions or of any one of them.

ARTICLE 12

Mandatory signs

Section D of Annex 1 to this Convention describes the mandatory signs and gives their meaning.

ARTICLE 13

Provisions applying generally to the signs described in Annex 1, sections C and D to this Convention

Special regulation signs

Section E of Annex 1 to this Convention describes the special regulation signs and gives their meaning.

ARTICLE 13 bis

Provisions applying generally to the signs described in Annex 1, sections C, ~~and D~~ and E to this Convention

1. ~~Prohibitory, and restrictive, and—mandatory as well as special regulation signs shall be placed in the immediate vicinity of the point where the obligation, restriction, or prohibition, restriction, obligation or special regulation begins or takes effect and may be repeated if the competent authorities consider it necessary. Nevertheless, if the competent authorities consider it advisable for reasons of visibility or in order to give users advance warning, these signs may be placed at a suitable distance in advance of the point where the obligation, restriction, or prohibition, restriction, obligation or special regulation applies. An additional panel H, 1 of in accordance with Annex 1, section H, subsection II, paragraph 1 (DISTANCE PANEL) shall be placed under signs set up in advance of the point where the obligation, restriction or prohibition applies.~~

2. ~~Regulatory~~ **Prohibitory, restrictive, and mandatory** signs placed level with ~~or shortly after~~ a sign indicating the beginning of a built-up area shall mean that the rule applies throughout the built-up area, unless a different

rule is notified by other signs on certain sections of the road in the built-up area.

3. Prohibitory and restrictive signs shall apply as from the place they are displayed until the point where a contrary sign is displayed, otherwise until the next intersection. If the prohibition or restriction should continue to be applied after the intersection the sign shall be repeated in accordance with provisions in domestic legislation. **If, however, these signs, as well as a mandatory or a special regulation sign are placed on a zonal validity sign,**

~~4. Where a regulatory sign applies to all roads in a zone (zonal validity), it shall be displayed in the way described in Annex 1, section E, subsection II, paragraph 8 (BEGINNING OF A ZONE)(a) to this Convention., they will apply to all roads in the zone to the point where the sign indicating the exit from the zone is set up (EXIT FROM A ZONE).~~

~~5. The exit from the zones referred to in paragraph 4 above shall be indicated in the way described in Annex 1, of section E, subsection II, paragraph 8 (b) of this Convention.~~

ARTICLE 13 bis

Special regulation signs

~~1. Section E of Annex 1 to this Convention describes the special regulation signs and gives their meaning.~~

~~2. Signs E, 7^a; E, 7^b; E, 7^c or E, 7^d and E, 8^a; E, 8^b; E, 8^c or E, 8^d shall notify road users that the general regulations governing traffic in built up areas in the territory of the State apply from signs E, 7^a; E, 7^b; E, 7^c; or E, 7^d to signs E, 8^a; E, 8^b; E, 8^c; or E, 8^d except in so far as different regulations may be notified by other signs on certain sections of road in the built up area. However, sign B, 4 shall always be placed on a priority road marked with sign B, 3 if that road ceases to have priority where it passes through the built up area. The provisions of Article 14, paragraphs 2, 3 and 4 apply to these signs.~~

~~2 bis. Sign E, 11^a shall be used for tunnels of 1,000 m or more and in cases provided for by domestic legislation. For tunnels of 1,000 m or more, the length shall be included either in the lower part of the sign, or on an additional panel H, 2, as described in Annex 1, section H. The name of the tunnel may be indicated according to Article 8, paragraph 3 of this Convention.~~

~~3. Signs E, 12^a; E, 12^b or E, 12^c shall be placed at pedestrian crossings when the competent authorities consider it advisable.~~

~~4. The special regulations signs shall be set up, with due regard to the requirements of Article 6, paragraph 1, only where the competent authorities consider it essential. They may be repeated; an additional panel placed below the sign may show the distance between the sign and the point which it indicates; this distance may also be inscribed on the lower part of the sign itself.~~

INFORMATIVE SIGNS

ARTICLE 14

~~1. Sections F and G of Annex 1 to this Convention describe the signs which convey useful information to road users-road users, or give examples of such signs, and also give some instructions for their use.~~

~~2. The inscription of words on informative signs (ii) of Article 5, paragraph 1 (c), in countries not using the Latin alphabet shall be both in the national language and in the form of a transliteration into the Latin alphabet reproducing as closely as possible the pronunciation in the national language.~~

3. ~~In countries not using the Latin alphabet, the words in Latin characters may be entered either on the same sign as the words in the national language or on a repeat sign.~~

4. ~~A sign shall not bear inscriptions in more than two languages.~~

ARTICLE 15

Advance direction signs

Advance direction signs shall be placed at such distance from the intersection as will make them most effective both by day and by night, having regard to road and traffic conditions, including the normal speed of vehicles and the distance at which the sign is visible; this distance need not exceed about 50 meters (55 yards) in built-up areas but shall be not less than 500 meters (550 yards) on motorways and other roads carrying fast traffic. The signs may be repeated. ~~An additional panel placed below the sign may show the distance between the sign and the intersection; this distance may also be shown on the lower part of the sign itself.~~

ARTICLE 16

Direction signs

1. ~~One~~ ~~Direction signs shall be placed near or at an intersection and may bear the names of several places; the names shall then appear one below the other on the sign. The letters used for one place name may be larger than those used for the others only if the place in question is the largest of them.~~

2. ~~When distances are shown, the figures expressing them shall be inscribed at the same height as the place name. On direction signs which are arrow shaped, these figures shall be placed between the place name and the point of the arrow; on rectangular shaped signs they shall be placed after the place name.~~

ARTICLE 17

Road identification signs

~~The signs used to identify roads either by their number, made up of figures, letters or a combination of figures and letters, or by their name, shall consist of that number or that name framed in a rectangle or shield. However, Contracting Parties having a route classification system may replace the rectangle by a route classification symbol.~~

Road identification signs shall be placed along roads which they identify. They may be also placed on advance direction signs, direction signs or confirmatory signs.

ARTICLE 18

Place identification signs

Place identification signs may be used placed to show the frontier between two countries or the boundary between two administrative divisions of the same country or the name of a river, mountain pass, beauty spot, etc. These signs shall differ conspicuously from the signs referred to in ~~Article 13 bis, paragraph 2, of this Convention~~ **Annex 1, section E, subsection II, paragraph 7 (BEGINNING OF A BUILT-UP AREA and END OF A BUILT-UP AREA).**

ARTICLE 19

Confirmatory signs

Confirmatory signs are ~~used~~ **placed** to confirm the direction of a road where the competent authorities consider it necessary, e.g. at the exit from a large

built-up area. They shall bear the name of one or more places, as provided in Article 16, paragraph 1, of this Convention. Where distances are shown, the figures expressing them shall be placed after the name of the locality.

ARTICLE 20

~~Deleted~~**Indication signs**

Indication signs are placed to provide advisory information to road users.

ARTICLE 21

Provisions applying generally to informative signs

1. ~~The informative signs referred to in Articles 15 to 19 of this Convention~~ **Advance direction signs, direction signs, road identification signs, place identification signs, and confirmatory signs** shall be set up where the competent authorities consider it advisable. ~~The other informative signs~~ **Information, facilities or service signs and indication signs** shall be set up, with due regard for the requirements of Article 6, paragraph 1, only where the competent authorities consider it essential; in particular, ~~the signs F, 2 to F, 7 shall be set up only on roads on which facilities for~~ **indicating** emergency repairs, refuelling, accommodation and refreshments **shall be set up only on roads on which these facilities** are rare.

2. ~~Informative signs may be repeated. An additional panel placed below the sign may show the distance between the sign and the point which it indicates; this distance may also be inscribed on the lower part of the sign itself.~~

ADDITIONAL PANELS

ARTICLE 22

~~Deleted~~

Section H of Annex 1 to this Convention describes the additional panels and gives their meaning.

Chapter III**TRAFFIC LIGHT SIGNALS**

ARTICLE 23

Signals for vehicular traffic

1. Subject to the provisions of paragraph 12 of this Article, the only lights which may be used as light signals for regulating vehicle traffic, other than those intended solely for public transport vehicles, are the following, which shall have the meanings here assigned to them:

- (a) Non-flashing lights:
 - (i) A green light shall mean that traffic may proceed; however, a green light for controlling traffic at an intersection shall not authorize drivers to proceed if traffic is so congested in the direction in which they are about to proceed that if they entered the intersection they would probably not have cleared it by the next change of phase;
 - (ii) A red light shall mean that traffic may not proceed; vehicles shall not pass the stop line or, if there is no stop line, shall not pass beyond the level of the signal or, if the signal is placed in the middle or on the opposite side of an intersection,

shall not enter the intersection or move on to a pedestrian crossing at the intersection;

(iii) An amber light, which shall appear alone or at the same time as the red light; when appearing alone it shall mean that no vehicle may pass the stop line or beyond the level of the signal unless it is so close to the stop line or signal when the light appears that it cannot safely be stopped before passing the stop line or beyond the level of the signal. Where the signal is placed in the middle or on the opposite side of an intersection the appearance of the amber light shall mean that no vehicle may enter the intersection or move on to a pedestrian crossing at the intersection unless it is so close to the crossing or the intersection when the light appears that it cannot be safely stopped before entering the intersection or moving on to the pedestrian crossing. When shown at the same time as the red light, it shall mean that the signal is about to change, but shall not affect the prohibition of passing indicated by the red light;

(b) Flashing lights:

(i) A red flashing light, or two red lights flashing alternately, one light appearing when the other is extinguished, and mounted on the same support, at the same height, and facing the same direction shall mean that vehicles shall not pass the stop line or, if there is no stop line, shall not pass beyond the level of the signal; these lights may be used only at ~~level crossings~~**level crossings**, at approaches to swing bridges or ferry-boat landing stages, and to indicate that traffic may not proceed because of fire-fighting vehicles entering the road or of the approach of an aircraft which will cross the road at a lower altitude;

(ii) A single amber flashing light or two amber lights flashing alternately shall mean that drivers may proceed but shall do so with particular care.

2. The signals of the three-colour system shall consist of three non-flashing lights, which shall be red, amber and green respectively; the green light shall appear only when the red and amber lights are extinguished.

3. The signals of the two-colour system shall consist of a non-flashing red light and a non-flashing green light. The red light and the green light shall not appear at the same time. Signals of the two-colour system shall be used only in temporary installation, subject to the period allowed under Article 3, paragraph 3, of this Convention for the replacement of existing installations.

~~3. bis.~~**3 bis.** (a) The provisions of Article 6, paragraphs 1, 2 and 3, of the Convention which relate to road signs shall apply to traffic light signals other than those used at ~~level crossings~~**level crossings**.

(b) Traffic light signals at intersections shall be placed before the intersection or in the middle of and above it; they may be repeated at the far side of the intersection and/or at the driver's eye level.

(c) In addition, it is recommended that domestic legislation should provide that traffic light signals:

(i) Shall be so placed as not to impede vehicles moving in traffic on the carriageway and, in the case of signals set up on verges, as to impede pedestrians as little as possible;

(ii) Shall be easily visible from a distance and readily understandable as they are approached; and

- (iii) Shall be standardized in the territory of each Contracting Party for the various categories of roads.
4. The lights of the three-colour and two-colour systems referred to in paragraphs 2 and 3 of this Article shall be arranged vertically or horizontally.
5. Where the lights are arranged vertically, the red light shall be placed uppermost; where the lights are arranged horizontally, the red light shall be placed on the side opposite to that appropriate to the direction of traffic.
6. In the three-colour system, the amber light shall be placed in the middle.
7. All the lights in the signals of the three-colour and two-colour systems referred to in paragraphs 2 and 3 of this Article shall be circular. The red flashing lights referred to in paragraph 1 of this Article shall likewise be circular.
8. A flashing amber light may be installed alone; such a light may also be used in place of a three-colour system at times when traffic is light.
9. In a three-colour system, the red, amber and green lights may be replaced by arrows of the same colour on a black background. When lighted up, these arrows have the same significance as the lights, but the prohibition or authorization is restricted to the direction or directions indicated by the arrow or arrows. Arrows signifying that traffic may or may not proceed straight ahead shall point upwards. Black arrows on a red, amber or green background may be used. These arrows have the same significance as the above-mentioned arrows.
10. Where a signal of a three-colour system includes one or more additional green lights showing one or more arrows, the lighting of such additional arrow or arrows shall, no matter what phase the three-colour system may be in at the time, mean that traffic may proceed in the direction or directions indicated by the arrow or arrows; it shall also mean that, when vehicles are in a lane reserved for traffic in the direction indicated by the arrow or the direction such traffic is required to take, their drivers must proceed in the direction indicated if by stopping they would obstruct the movement of vehicles behind them in the same lane, provided always that vehicles in the traffic stream they are joining must be allowed to pass and that pedestrians must not be endangered. These additional green lights should preferably be placed at the same level as the normal green light.
11. (a) Where green or red lights are placed above traffic lanes shown by longitudinal markings on a carriageway having more than two lanes, the red light shall mean that traffic may not proceed along the lane over which it is placed and the green light shall mean that traffic may so proceed. The red light thus placed shall be in ~~the form of two inclined crossed bars~~ **a form of X** and the green light in the form of an arrow pointing downwards.
- (b) When the competent authorities judge it necessary to introduce an "intermediate" or "transition" signal for the light signals, it should be in the form of an amber or white arrow pointing diagonally downwards to the left or to the right, or two such arrows, one pointing in each direction; these arrows may be flashing. These amber or white arrows mean that the lane is about to be closed to traffic and that the ~~road users~~ **road users** on that lane must move over to the lane indicated by the arrow.
12. Domestic legislation may provide for the installation at certain ~~level-crossings~~ **level crossings** of a slow-flashing lunar white light meaning that traffic may proceed.
13. In cases where traffic light signals apply to cyclists only, this restriction may be clarified, if to do so is necessary in order to avoid confusion, by including the silhouette of a cycle in the signal itself or by using a signal of small size supplemented by ~~a rectangular plate~~ **an additional panel** showing

a cycle. **Such an additional panel used in conjunction with the traffic light can be placed below, above or beside it.**

ARTICLE 24

Signals for pedestrians only

1. The only lights which may be used as light signals for pedestrians only are the following, which shall have the meanings here assigned to them:
 - (a) Non-flashing lights:
 - (i) A green light shall mean that pedestrians may cross;
 - (ii) An amber light shall mean that pedestrians may not cross, but that those already on the carriageway may continue to the other side;
 - (iii) A red light shall mean that pedestrians may not enter the carriageway;
 - (b) Flashing lights: a flashing green light shall mean that the period during which pedestrians may cross the carriageway is about to end and the red light is about to appear.
2. Light signals for pedestrians shall preferably be of the two-colour system, comprising two lights, red and green respectively; however, they may be of the three-colour system, comprising three lights, red, amber and green respectively. Two lights shall never be shown simultaneously.
3. The lights shall be arranged vertically, with the red light always at the top and the green light always at the bottom. The red light shall preferably be in the form of a standing pedestrian or of standing pedestrians and the green light in the form of a walking pedestrian or of walking pedestrians.
4. Light signals for pedestrians shall be so designed and arranged as to exclude any possibility of their being mistaken by drivers for light signals for vehicular traffic.
5. Light signals for pedestrians may be supplemented by audible or tactile signals at pedestrian crossings to facilitate crossings of the carriageway by blind pedestrians.

Chapter IV

ROAD MARKINGS

ARTICLE 25

Carriageway markings (road markings) shall be used, when the competent authority considers it necessary, to regulate traffic or to warn or guide ~~road users~~ **road users**. They may be used either alone or in conjunction with other signs or signals to emphasize or clarify their meaning.

ARTICLE 26

1. A longitudinal marking consisting of a continuous line on the carriageway shall mean that vehicles are not permitted to cross or straddle that line and, when the line separates the two directions of traffic, that vehicles are not permitted to travel on that side of the line which, for the driver, is opposite to the edge of the carriageway appropriate to the direction of traffic. A longitudinal marking consisting of two continuous lines shall have the same meaning.
2. (a) A longitudinal marking consisting of a broken line on the carriageway shall not have a prohibitory meaning, but shall be used either:
 - (i) To demarcate lanes for the purpose of guiding traffic; or

(ii) To give warning of the approach to a continuous line and the prohibition that line conveys, or of the approach to another section of road presenting a particular danger.

(b) The ratio between the length of the gaps between the strokes and the length of the strokes shall be substantially smaller where broken lines are used for the purposes referred to in subparagraph (a) (ii) of this paragraph than where they are used for the purpose referred to in subparagraph (a) (i) thereto.

(c) Double broken lines may be used to delineate a lane or lanes in which the direction of the traffic flow may be reversed in conformity with Article 23, paragraph 11, of this Convention.

3. Where a longitudinal marking consists of a continuous line adjacent to a broken line on the carriageway, drivers shall take account only of the line that appears on their side. This provision shall not prevent drivers who have overtaken in the manner permitted from resuming their normal position on the carriageway.

4. For the purposes of this Article, longitudinal lines used to mark the edges of the carriageway in order to make them more visible, longitudinal lines connected to transverse lines used to demarcate parking spaces on the carriageway, and longitudinal lines showing a prohibition or restrictions on standing or parking shall not be regarded as longitudinal markings.

ARTICLE 26 bisbis

1. The marking of lanes reserved for certain categories of vehicles, including cycle lanes, shall be by means of lines which should be clearly distinguished from other continuous or broken lines on the carriageway, notably by being wider and with less space between strokes.

2. When a lane is reserved for regular public transport service vehicles the worded road marking shall be the word "BUS" or the letter "A". The sign indicating such a ~~lane~~ **lane described in Annex 1, section E, subsection II, paragraph 2 (LANE RESERVED FOR BUSES)** shall be ~~of the square type described in annex 1, section E, or of the round type described in annex 1, section D, of the present~~ **include the additional panel showing the white symbol of a bus on a blue ground of the type described in Annex 1, section H, paragraph 3 (ROAD USER PANEL) of this Convention or only the symbol of a bus.** Diagrams 28a and 28b shown in ~~a~~Annex 2 to this Convention are examples of markings for a lane reserved for regular public transport service vehicles.

3. Domestic legislation shall specify under what conditions other vehicles may use or go across the lane referred to in paragraph 1.

ARTICLE 27

1. A transverse marking consisting of a continuous line across one or more traffic lanes shall mark the line behind which drivers are required by the sign **described in Annex 1, section B, paragraph 2 (STOP)** ~~in B, 2, "STOP", referred to in Article 10, paragraph 3, of this Convention,~~ to stop.

Such a marking may also be used to show the line behind which drivers may be required to stop by a light signal, or by a signal given by an authorized official directing traffic, or before a ~~level crossing~~ **level crossing**. The word **"STOP" inscription** may be marked on the carriageway in advance of the markings accompanying ~~the sign B, 2~~ **described in Annex 1, section B, paragraph 2 (STOP)**.

2. Unless this is technically impossible, the transverse marking described in paragraph 1 of this Article shall be placed on the carriageway wherever a sign B, 2 **described in Annex 1, section B, paragraph 2 (STOP)**, is set up.

3. A transverse marking consisting of a broken line across one or more traffic lanes shall show the line which vehicles may not normally pass when giving way in compliance with the sign **described in Annex 1, section B, paragraph 1 (GIVE WAY)**~~B, 1 "GIVE WAY", referred to in Article 10, paragraph 2, of this Convention~~. In advance of such a marking, a triangle with broad sides, having one side parallel to the marking and the opposite vertex pointing towards approaching vehicles, may be marked on the carriageway to symbolize **this sign-B, 1**.
4. To mark pedestrian crossings, relatively broad stripes, parallel to the axis of the carriageway, ~~should preferably~~ **shall** be used.
5. To mark cyclist crossings, either transverse lines, or other markings which cannot be confused with those of pedestrian crossings, shall be used.

ARTICLE 28

1. Other markings on the carriageway, such as arrows, parallel or oblique stripes, or inscriptions, may be used to repeat the instructions given by signs or to give ~~road users~~ **road users** information which cannot be suitably conveyed by signs. Such markings shall be used, in particular, to show the boundaries of parking zones or strips, to mark bus or trolleybus stops where parking is prohibited, and for pre-selection before intersections. However, if there is an arrow on the carriageway where it is divided into traffic lanes by means of longitudinal markings, drivers shall follow the direction or one of the directions indicated in the lane along which they are travelling.
2. Subject to the provisions of Article 27, paragraph 4 of this Convention which relate to pedestrian crossings, the marking of part of the carriageway or of an area raised slightly above the level of the carriageway by parallel oblique stripes framed by a continuous line, or by broken lines, shall, in the case of areas framed by a continuous line, mean that vehicles must not enter that area, and in the case of areas framed by broken lines, that vehicles shall not enter that area unless it can be seen that it is safe to do so or in order to turn into a joining road on the opposite side of the carriageway.
3. A zigzag line at the side of the carriageway shall mean that parking on that side of the carriageway is prohibited as far as the line extends. Such line possibly together with the word "BUS" or with the letter "A" may be used to indicate a bus or trolleybus stop.

ARTICLE 29

1. The road markings mentioned in Articles 26 and 28 of this Convention may be painted on the carriageway or applied in any other way provided that it is equally effective.
2. If road markings are painted, they shall be yellow or white; however, blue may be used for markings showing places where parking is permitted but subject to some conditions or restrictions (limit of duration, payment, category of user, etc.). When both yellow and white are used in the territory of a Contracting Party, markings of the same class shall be of the same colour. For the purposes of this paragraph, the term "white" shall include shades of silver or light grey.
3. In tracing out the inscriptions, symbols and arrows of road markings, account shall be taken of the need to elongate them considerably in the direction of movement of traffic, because of the very narrow angle at which they are seen by drivers.
4. Road markings intended for moving vehicles shall be easily recognized in good time by drivers. They must be visible during the day and at night. It is

recommended that such markings, especially in areas where lighting is insufficient, be retroreflective.

ARTICLE 29 ~~bis~~ **bis**

1. When permanent road markings are to be modified for a specific period, in particular because of road works or diversions, temporary markings shall be applied in colours different from the colours used for permanent markings.
2. Temporary markings shall take precedence over permanent markings and road users are required to conform to them. When the simultaneous presence of permanent and temporary road markings could be a source of confusion, the permanent markings shall be covered over or removed.
3. Temporary markings shall preferably be retroreflective and may be supplemented by beacons, ~~eats~~ **cat's** eyes or reflectors with a view to improving traffic guidance.

ARTICLE 30

Annex 2 to this Convention is a set of recommendations relating to the layout and design of road markings.

Chapter V

MISCELLANEOUS

ARTICLE 31

Signs for ~~r~~Road works

1. The limits of road works on the carriageway shall be clearly shown.
2. Where the extent of the road works and the volume of traffic justify it, the limits of the works shall be marked by setting up continuous or discontinuous barriers painted with alternate red and white, red and yellow, black and white, or black and yellow stripes, and in addition, at night, if the barriers are not reflectorized, by lights and reflecting devices. Reflecting devices and fixed lights used for this purpose shall be red or dark yellow and flashing lights shall be dark yellow. However:
 - (a) Lights and devices visible only to traffic moving in one direction and marking the limits of road works on the opposite side of the road from that traffic may be white;
 - (b) Lights and devices marking the limits of road works separating the two directions of traffic may be white or light yellow.

ARTICLE 32

Marking by ~~H~~Lights or reflecting devices to mark the edge of the carriageway

Each Contracting Party shall adopt for the whole of its territory the same colour or the same system of colours for the lights or reflecting devices used to mark the edge of the carriageway.

~~LEVEL CROSSINGS~~ **LEVEL CROSSINGS**

ARTICLE 33

1. (a) Where a signalling system is installed at a ~~level crossing~~ **level crossing** to give warning of the approach of trains or of the imminent closing of the gates (barriers) or half-gates (half-barriers), it shall consist of a red flashing light or of red lights flashing alternately, as specified in Article 23, paragraph 1(b), of this Convention. However:

- (i) Flashing red lights may be supplemented or replaced by light signals of the three-colour red-amber-green system described in Article 23, paragraph 2, of this Convention, or by such a signal without the green light, if other three-colour light signals are installed on the road near the ~~level-crossing~~**level crossing** or if the crossing is equipped with gates;
- (ii) On earth-tracks (dirt roads) where traffic is very light and on footpaths, only a sound signal need be used.
- (b) The light signals may be supplemented by a sound signal in all cases.

2. The light signals shall be installed on the edge of the carriageway appropriate to the direction of traffic; whenever conditions such as the visibility of the signals or the density of traffic so require, the lights shall be repeated on the other side of the road. However, if it is considered preferable because of local conditions, the lights may be repeated on an island in the middle of the carriageway, or placed above the carriageway.

3. In accordance with Article 10, paragraph 42, of this Convention, ~~the sign B, 2, "STOP"~~ **described in Annex 1, section B, paragraph 2 (STOP)**, may be set up at a ~~level-crossing~~**level crossing** which has neither gates, half-gates nor light signals giving warning of the approach of trains; at ~~level-crossings~~**level crossings** where this sign is displayed, drivers shall stop at the stop line or, in the absence of such a line, level with the sign and not move off again until they have ascertained that no train is approaching.

ARTICLE 34

1. At ~~level-crossings~~**level crossings** equipped with gates or staggered half-gates on either side of the railway line, the presence of such gates or half-gates across the road shall mean that no ~~road-user~~**road user** may proceed beyond the nearest gate or half-gate; the movement of gates towards a position across the road and the movement of half-gates shall have the same meaning.

2. The showing of the red light or lights mentioned in Article 33, paragraph 1, subparagraph (a), of this Convention, or the operation of the sound signal mentioned in the said paragraph 1, shall likewise mean that no ~~road-user~~**road user** may proceed beyond the stop line or, if there is no stop line, beyond the level of the signal. The showing of the amber light of the three colour system mentioned in Article 33, paragraph 1 (a) (i), shall mean that no ~~road-user~~**road user** may proceed beyond the stop line or, if there is no stop line, beyond the level of the signal, unless the vehicle concerned is so close to the signal when the amber light appears that it cannot safely be stopped before passing the signal.

ARTICLE 35

1. The gates and half-gates of ~~level-crossings~~**level crossings** shall be clearly marked in alternate stripes of red and white, red and yellow, black and white, or black and yellow. They may, however, be coloured white or yellow only, provided that a large red disc is displayed at the centre.

2. At all ~~level-crossings~~**level crossings** which have neither gates nor half-gates there shall be placed, in the immediate vicinity of the railway ~~line~~, ~~the sign A, 28 as described in Annex 1, section A~~ **described in Annex 1, section A, subsection II, paragraph 24 (OTHER LEVEL CROSSINGS)**. If there is a light signal giving warning of the approach of trains or sign ~~described in Annex 1, section B, paragraph 2 (STOP)~~ **described in Annex 1, section B, paragraph 2 (STOP)**, ~~LEVEL CROSSINGS sign A, 28~~ shall be placed on the same support as the light signal or ~~STOP sign B, 2~~. Placing of **LEVEL CROSSINGS** ~~sign A, 28~~ is not mandatory at:

- (a) An intersection between a road and a railway ~~track~~ at which rail traffic proceeds very slowly and road traffic is regulated by a railway ~~man~~ **officer** making the necessary hand signals; or
- (b) An intersection between a railway ~~track~~ and either an earth-track (dirt road) where traffic is very light, or a footpath.

ARTICLE 36

1. Because of the special danger presented by ~~level crossings~~ **level crossings**, the Contracting Parties undertake:

(a) To have one of the danger warning signs ~~bearing one of the symbols A, 25; A, 26 or A, 27~~ **described in Annex 1, section A, subsection II, paragraph 23 (LEVEL CROSSINGS WITH GATES), paragraph 24 (OTHER LEVEL CROSSINGS) or paragraph 25 (INTERSECTION WITH A TRAMWAY)** placed in advance of all ~~level crossings~~ **level crossings**; however, no sign needs to be set up:

- (i) In special cases which may arise in built-up areas;
- (ii) On earth-tracks (dirt roads) and paths where power-driven vehicular traffic is exceptional;

(b) To have all ~~level crossings~~ **level crossings** equipped with gates or half-gates or with a signal giving warning of the approach of trains, unless ~~road users~~ **road users** can see the railway line on both sides of the ~~level crossing~~ **level crossing** for such a distance that, allowing for the maximum speed of the trains, the driver of a road vehicle approaching the railway line from either side has time to stop before proceeding on to the ~~level crossing~~ **level crossing** if a train is in sight, and in addition that ~~road users~~ **road users** who are already on the crossing when a train appears have time to reach the other side; however, it shall be open to the Contracting Parties to derogate from the provisions of this subparagraph at ~~level crossings~~ **level crossings** where trains travel relatively slowly or power-driven vehicular traffic on the road is light;

~~(c) To have every level crossing~~ **level crossing** having gates or half-gates operated from a position from which such gates or half-gates cannot be seen equipped with one of the systems for signalling the approach of trains referred to in Article 33, paragraph 1, of this Convention;

(d) To have every ~~level crossing~~ **level crossing** having gates or half-gates operated automatically by the approach of trains equipped with one of the systems for signalling the approach of trains referred to in Article 33, paragraph 1, of this Convention;

(e) In order to make gates and half-gates more visible, to have them equipped with reflecting material or reflecting devices and, if need be, to illuminate them at night; in addition, on roads where there is heavy motor traffic at night, to equip the danger warning signs installed in advance of the ~~level crossing~~ **level crossing** with reflecting material or reflecting devices and, if need be, to illuminate them at night;

(f) Wherever possible, near ~~level crossings~~ **level crossings** equipped with half-gates to have a longitudinal marking placed in the middle of the carriageway prohibiting vehicles which approach the ~~level crossing~~ **level crossing** from encroaching on the half of the carriageway reserved for traffic in the opposite direction or even to install directional islands separating the two opposed streams of traffic.

2. The provisions of this Article shall not apply in the cases referred to in the last sentence of Article 35, paragraph 2, of this Convention.

Chapter VI

FINAL PROVISIONS

ARTICLE 37

1. This Convention shall be open at United Nations Headquarters, New York, until 31 December 1969 for signature by all States Members of the United Nations or of any of the specialized agencies or of the International Atomic Energy Agency or Parties to the Statute of the International Court of Justice, and by any other State invited by the General Assembly of the United Nations to become a Party to the Convention.
2. This Convention is subject to ratification. The instruments of ratification shall be deposited with the Secretary-General of the United Nations.
3. This Convention shall remain open for accession by any of the States referred to in paragraph 1 of this Article. The instruments of accession shall be deposited with the Secretary-General.

ARTICLE 38

1. Any State may, at the time of signing or ratifying this Convention, or of acceding thereto, or at any time thereafter, declare by notification addressed to the Secretary-General that the Convention shall become applicable to all or any of the territories for the international relations of which it is responsible. The Convention shall become applicable to the territory or territories named in the notification 30 days after the receipt of the notification by the Secretary-General or on the date of entry into force of the Convention for the State making the notification, whichever is the later.
2. Any State which makes a notification under paragraph 1 of this Article shall notify on behalf of the territories on whose behalf that notification was made the declarations provided for in Article 46, paragraph 2 of this Convention.
3. Any State which has made a declaration under paragraph 1 of this Article may at any time thereafter declare by notification addressed to the Secretary-General that the Convention shall cease to be applicable to the territory named in the notification and the Convention shall cease to be applicable to such territory one year from the date of receipt by the Secretary-General of the notification.

ARTICLE 39

1. This Convention shall enter into force 12 months after the date of deposit of the fifteenth instrument of ratification or accession.
2. For each State ratifying or acceding to this Convention after the deposit of the fifteenth instrument of ratification or accession, the Convention shall enter into force 12 months after the date of deposit by such State of its instrument of ratification or accession.

ARTICLE 40

Upon its entry into force, this Convention shall terminate and replace, in relations between the Contracting Parties, the Convention concerning the Unification of Road Signals, opened for signature at Geneva on 30 March 1931, or the Protocol on Road Signs and Signals, opened for signature at Geneva on 19 September 1949.

ARTICLE 41

1. After this Convention has been in force for one year, any Contracting Party may propose one or more amendments to the Convention. The text of

any proposed amendment, accompanied by an explanatory memorandum, shall be transmitted to the Secretary-General, who shall communicate it to all Contracting Parties. The Contracting Parties shall have the opportunity of informing him within a period of 12 months following the date of its circulation whether they: (a) accept the amendment; or (b) reject the amendment; or (c) wish that a conference be convened to consider the amendment. The Secretary-General shall also transmit the text of the proposed amendment to all other States referred to in Article 37, paragraph 1 of this Convention.

2. (a) Any proposed amendment communicated in accordance with the preceding paragraph shall be deemed to be accepted if within the period of 12 months referred to in the preceding paragraph less than one-third of the Contracting Parties inform the Secretary-General that they either reject the amendment or wish that a conference be convened to consider it. The Secretary-General shall notify all Contracting Parties of each acceptance or rejection of any proposed amendment and of requests that a conference be convened. If the total number of such rejections and requests received during the specified period of 12 months is less than one-third of the total number of Contracting Parties, the Secretary-General shall notify all Contracting Parties that the amendment will enter into force six months after the expiry of the period of 12 months referred to in the preceding paragraph for all Contracting Parties except those which, during the period specified, have rejected the amendment or requested the convening of a conference to consider it.

(b) Any Contracting Party which, during the said period of 12 months, has rejected a proposed amendment or requested the convening of a conference to consider it may at any time after the end of such period notify the Secretary-General that it accepts the amendment, and the Secretary-General shall communicate such notification to all the other Contracting Parties. The amendment shall enter into force, with respect to the Contracting Parties which have notified their acceptance, six months after receipt by the Secretary-General of their notification.

3. If a proposed amendment has not been accepted in accordance with paragraph 2 of this Article and if within the period of 12 months specified in paragraph 1 of this Article less than half of the total number of Contracting Parties inform the Secretary-General that they reject the proposed amendment and if at least one-third of the total number of Contracting Parties, but not less than 10, inform him that they accept it or wish a conference to be convened to consider it, the Secretary-General shall convene a conference for the purpose of considering the proposed amendment or any other proposal which may be submitted to him in accordance with paragraph 4 of this Article.

4. If a conference is convened in accordance with paragraph 3 of this Article, the Secretary-General shall invite to it all States referred to in Article 37, paragraph 1 of this Convention. He shall request all States invited to the conference to submit to him, at least six months before its opening date, any proposals which they may wish the conference to consider in addition to the proposed amendment and shall communicate such proposals, at least three months before the opening date of the conference, to all States invited to the conference.

5. (a) Any amendment to this Convention shall be deemed to be accepted if it has been adopted by a two-thirds majority of the States represented at the Conference, provided that such majority comprises at least two-thirds of the number of Contracting Parties represented at the conference. The Secretary-General shall notify all Contracting Parties of the adoption of the amendment, and the amendment shall enter into force 12 months after the date of his notification of all Contracting Parties except those which during that period have notified the Secretary-General that they reject the amendment.

(b) A Contracting Party which has rejected an amendment during the said period of 12 months may at any time notify the Secretary-General that it accepts the amendment, and the Secretary-General shall communicate such notification to all the other Contracting Parties. The amendment shall enter into force, with respect to the Contracting Party which has notified its acceptance, six months after receipt by the Secretary-General of the notification or at the end of the said period of 12 months, whichever is later.

6. If the proposed amendment is not deemed to be accepted pursuant to paragraph 2 of this Article and if the conditions prescribed by paragraph 3 of this Article for convening a conference are not fulfilled, the proposed amendment shall be deemed to be rejected.

ARTICLE 42

Any Contracting Party may denounce this Convention by written notification to the Secretary-General. The denunciation shall take effect one year after the date of receipt by the Secretary-General of such notification.

ARTICLE 43

This Convention shall cease to be in force if the number of Contracting Parties is less than five for any period of 12 consecutive months.

ARTICLE 44

Any dispute between two or more Contracting Parties which relates to the interpretation or application of this Convention and which the Parties are unable to settle by negotiation or other means of settlement may be referred, at the request of any of the Contracting Parties concerned, to the International Court of Justice for decision.

ARTICLE 45

Nothing in this Convention shall be construed as preventing a Contracting Party from taking such action, compatible with the provisions of the Charter of the United Nations and limited to the exigencies of the situation, as it considers necessary to its external or internal security.

ARTICLE 46

1. Any State may, at the time of signing this Convention or of depositing its instrument of ratification or accession, declare that it does not consider itself bound by Article 44 of this Convention. Other Contracting Parties shall not be bound by Article 44 with respect to any Contracting Party which has made such a declaration.

2. (a) At the time of depositing its instrument of ratification or accession, every State shall, by notification addressed to the Secretary-General, declare for the purposes of the application of this Convention:

(i) Which of the models ~~A^a and A^b~~ **one or two** it chooses as a danger warning sign (Art-~~icle~~ 9, ~~paragraph~~ 1), ~~and~~

~~(ii) Which of the models B, 2^a and B, 2^b it chooses as a stop sign (Art. 10, para. 3).~~

Any State may, subsequently, at any time, by notification addressed to the Secretary-General alter its choice by replacing its declaration by another.

(b) At the time of depositing its instrument of ratification or accession, any State may, by notification addressed to the Secretary-General, declare that for the purposes of the application of this Convention it treats Mopeds as motor cycles (~~a~~Art-~~icle~~ 1, (l)).

By notification addressed to the Secretary-General, any State may subsequently, at any time, withdraw its declaration.

3. The declarations provided for in paragraph 2 of this Article shall become effective six months after the date of receipt by the Secretary-General of notification of them or on the date on which the Convention enters into force for the State making the declaration, whichever is the later.

4. Reservations to this Convention and its Annexes, other than the reservation provided for in paragraph 1 of this Article, shall be permitted on condition that they are formulated in writing and, if formulated before the deposit of the instrument of ratification or accession, are confirmed in that instrument. The Secretary-General shall communicate such reservations to all States referred to in Article 37, paragraph 1 of this Convention.

5. Any Contracting Party which has formulated a reservation or made a declaration under paragraphs 1 and 4 of this Article may withdraw it at any time by notification addressed to the Secretary-General.

6. A reservation made in accordance with paragraph 4 of this Article:

(a) Modifies for the Contracting Party which made the reservation the provisions of the Convention to which the reservation relates, to the extent of the reservation;

(b) Modifies those provisions to the same extent for the other Contracting Parties in their relations with the Contracting Party which entered the reservation.

ARTICLE 47

In addition to the declarations, notifications and communications provided for in Articles 41 and 46 of this Convention, the Secretary-General shall notify all the States referred to in Article 37, paragraph 1, of the following:

(a) Signatures, ratifications and accessions under Article 37;

(b) Declarations under Article 38;

(c) The dates of entry into force of this Convention in accordance with Article 39;

(d) The date of entry into force of amendments to this Convention in accordance with Article 41, paragraphs 2 and 5;

(e) Denunciations under Article 42;

(f) The termination of this Convention under Article 43.

ARTICLE 48

The original of this Convention, of which the Chinese, English, French, Russian and Spanish texts done in a single copy are equally authentic, shall be deposited with the Secretary-General of the United Nations, who shall send certified true copies thereof to all the States referred to in Article 37,

paragraph 1, of this Convention.

IN WITNESS WHEREOF the undersigned Plenipotentiaries, being duly authorized by their respective Governments, have signed this Convention.

DONE AT Vienna this eighth day of November, one thousand nine hundred and sixty-eight.

Annex 1

ROAD SIGNS

Section A

DANGER WARNING SIGNS

I. Models, general characteristics, and symbols

1. The "A" DANGER WARNING signs shall be ~~model Aa or model Ab both described here and reproduced in Annex 3 of two models~~, except signs ~~A, 28 and A, 29 described in paragraphs 28 and 29 below respectively~~ **to be placed in the immediate vicinity of level crossings and additional signs at approaches to level crossings or opening bridges**. Model ~~Aa one~~ is an equilateral triangle having one side horizontal and the opposite vertex above it; the ground is white or yellow and the border red. Model ~~Ab two~~ is a square with one diagonal vertical; the ground is yellow and the border, which is only a rim, is black **or dark blue**. Unless the description specifies otherwise, the symbols displayed on these signs shall be black or dark blue.

2. The size of the normal sized sign of model ~~Aa one~~ shall measure approximately 0.90 m; that of the small sized sign of model ~~Aa one~~ shall measure not less than 0.60 m. The size of the normal sized sign of model ~~Ab two~~ shall measure approximately 0.60 m; that of the small sign of model ~~Ab two~~ shall measure not less than 0.40 m.

3. ~~As regards the choice between models Aa and Ab, see Article 5, paragraph 2, and Article 9, paragraph 1, of this Convention. The choice between the models shall be made in accordance with Article 5, paragraph 2, and Article 9, paragraph 1, of this Convention.~~

II. Symbols and instructions for the use of signs **Definitions and images**

1. Dangerous bend or bends

~~Warning of a dangerous bend or succession of dangerous bends shall be given by one of~~

~~the following symbols, whichever is appropriate:~~

~~(a) A, 1a: left bend~~

~~(b) A, 1b: right bend~~

~~(c) A, 1c: double bend, or succession of more than two bends, the first to the left~~

~~(d) A, 1d: double bend, or succession of more than two bends, the first to the right.~~

LEFT BEND

A-01.1 gives warning of a dangerous left bend.

Images of A-01.1

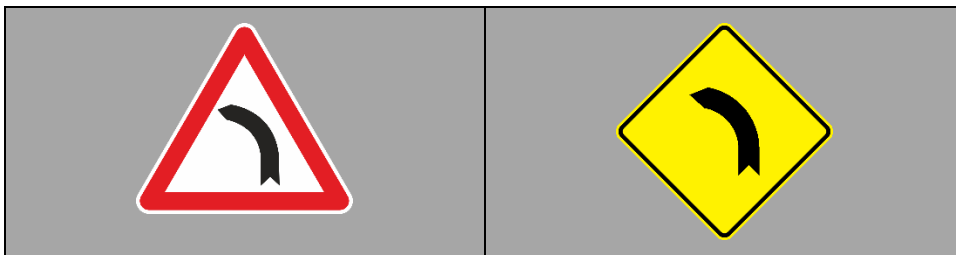

RIGHT BEND

A-01.2 gives warning of a dangerous right bend.

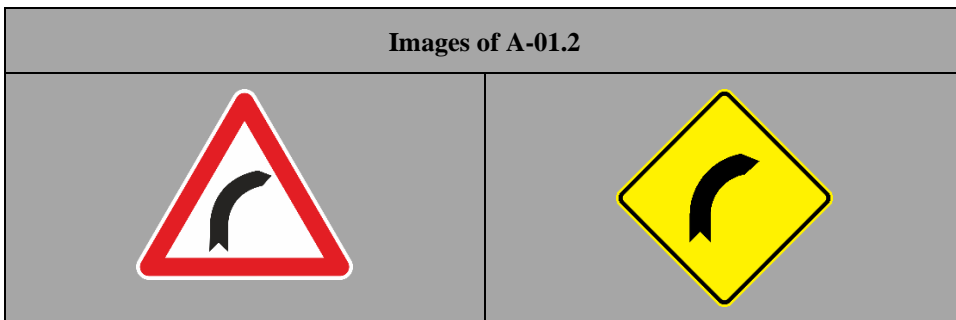

DOUBLE BEND OR SUCCESSION OF MORE THAN TWO BENDS, THE FIRST TO THE LEFT

A-01.3 gives warning of a dangerous double bend, or a succession of more than two bends, the first to the left.

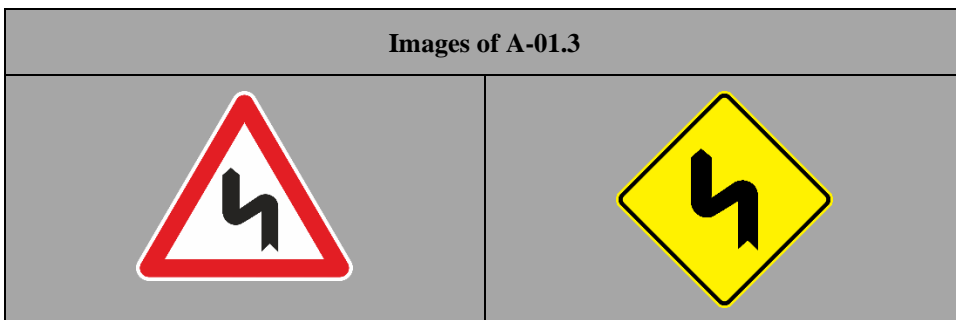

DOUBLE BEND OR SUCCESSION OF MORE THAN TWO BENDS, THE FIRST TO THE RIGHT

A-01.4 gives warning of a dangerous double bend, or a succession of more than two bends, the first to the right.

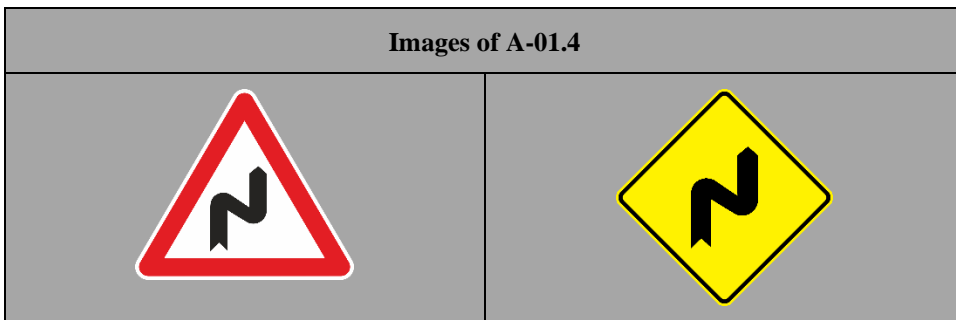

2. Dangerous descent

DANGEROUS DESCENT

(a) To give warning of a steep descent symbol A, 2a shall be used with the sign of model Aa, or symbol A, 2b with the sign of model Ab.

(b) The left hand part of symbol A, 2a shall occupy the left hand corner of the sign panel and its base shall extend over the whole width of the panel. The figure in symbols A, 2a and A, 2b shows the gradient as a percentage; it may be replaced by a ratio (1:10). It shall, however, be open to Contracting Parties taking into account as far as possible the provisions of Article 5, paragraph 2 (b) of this Convention, to use, instead of symbol A, 2a or A, 2b, symbol A, 2c if they have adopted the sign of model Aa and symbol A, 2d if they have adopted the sign of model Ab.

A-02.0 gives warning of a dangerous descent. The symbol of a car or a percentage or both, may be used. An arrow in the ground colour of the sign may be embedded into the black triangular part of the symbol when the percentage symbol is used.

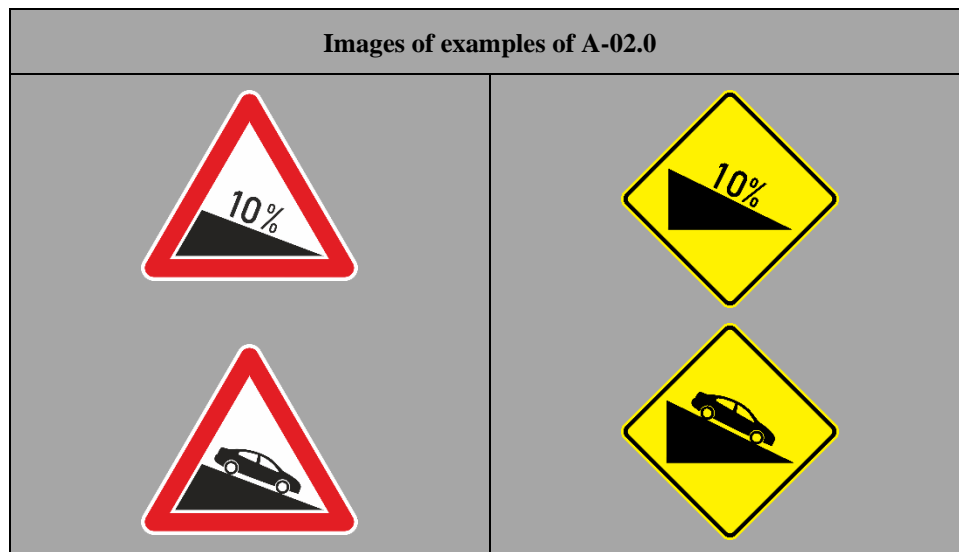

3. Steep ascent

STEEP ASCENT

(a) To give warning of a steep ascent, symbol A, 3a shall be used with the sign of model Aa, or symbol A, 3b with the sign of model Ab.

(b) The right hand part of symbol A, 3a shall occupy the right hand corner of the sign panel and its base shall extend over the whole width of the panel. The figure in symbols A, 3a and A, 3b shows the gradient as a percentage; it may be replaced by a ratio (1:10). It shall, however, be open to Contracting Parties which have chosen symbol A, 2c as the symbol for a dangerous descent to use symbol A, 3c instead of A, 3a, and to Contracting Parties which have chosen symbol A, 2d to use symbol A, 3d instead of A, 3b.

A-03.0 gives warning of a steep ascent. The symbol of a car or a percentage or both, may be used. An arrow in the ground colour of the sign may be embedded into the black triangular part of the symbol when the percentage symbol is used.

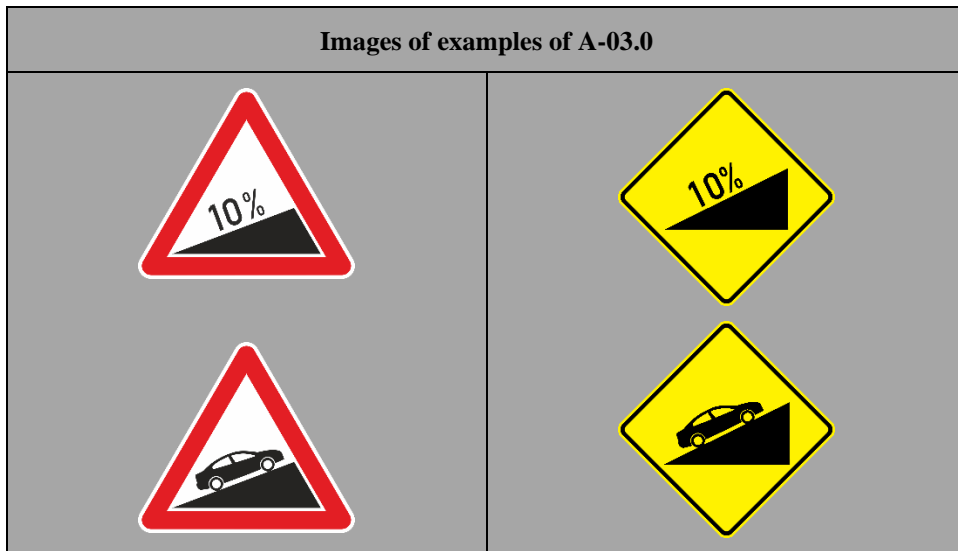

4. Carriageway narrows

CARRIAGEWAY NARROWS

~~Warning that the carriageway ahead is narrower shall be given by the symbol A, 4a or by a symbol showing the outline of the road more clearly, such as A, 4b.~~

A-04.1 gives warning that the carriageway ahead is narrower on the left-hand side and on the right-hand side. This sign shall not be used for indicating a reduction in the number of lanes.

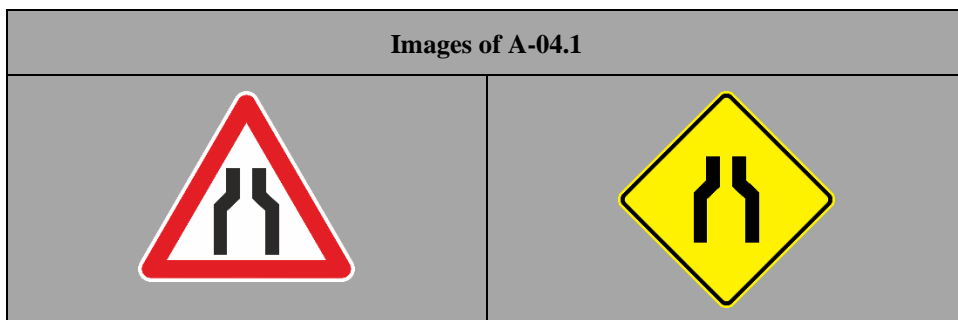

CARRIAGEWAY NARROWS LEFT

A-04.2 gives warning that the carriageway ahead is narrower on the left-hand side. This sign shall not be used for indicating a reduction in the number of lanes.

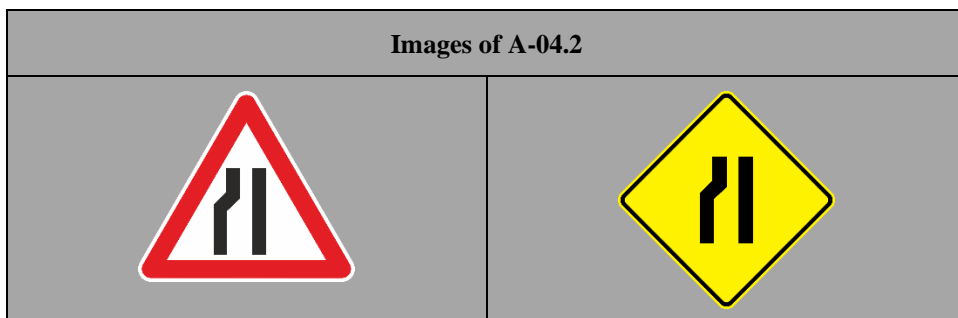

CARRIAGEWAY NARROWS RIGHT

A-04.3 gives warning that the carriageway ahead is narrower on the right-hand side. This sign shall not be used for indicating a reduction in the number of lanes.

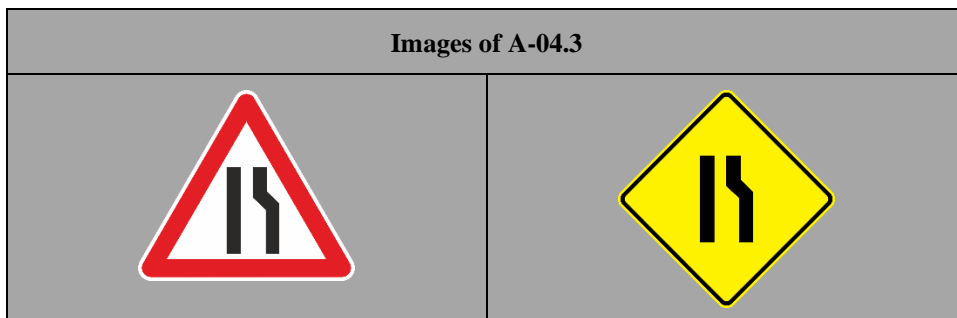

5. Swing Opening bridge

OPENING BRIDGE

(a) Warning of a swing bridge shall be given by the symbol A-5.

A-05.0 gives warning of an opening bridge.

(b) A rectangular panel of model A-29a ~~The sign A-26.1~~ described in paragraph 29 below may be placed below ~~this sign~~ the danger warning sign bearing symbol A-5 provided that ~~panels of model signs A-29b and A-29c~~ **A-26.2 and A-26.3** described in that paragraph are set up at approximately one-third and two-thirds of the distance between the ~~sign A-26.1~~ bearing symbol A-5 and the opening bridge.

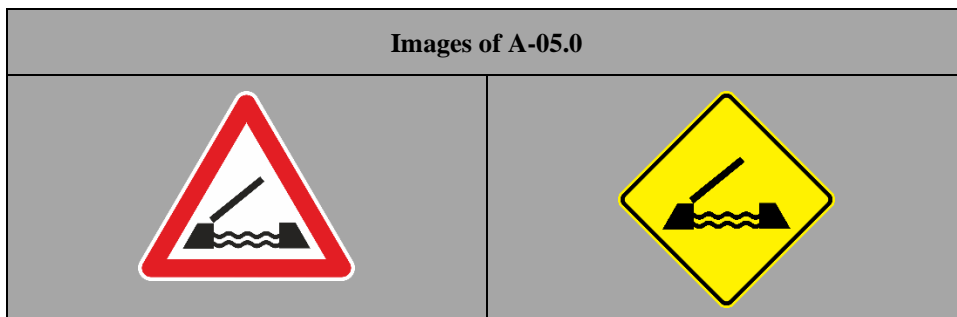

6. Road leads on to quay or riverbank

QUAY OR RIVERBANK

Warning that the road is about to lead on to a quay or river bank shall be given by symbol A-6.

A-06.0 gives warning that the road is about to lead on to a quay or riverbank.

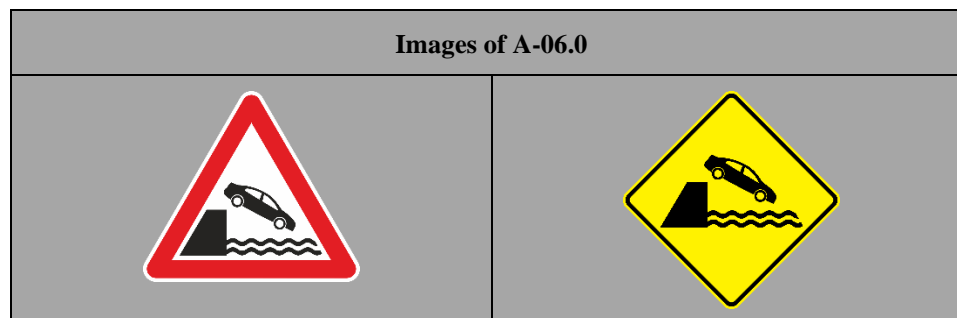

7. Uneven road

UNEVEN ROAD

~~(a) Warning of dips, hump bridges or ridges, or of sections where the carriageway is in bad condition shall be given by symbol A, 7a.~~

~~(b) To give warning of a hump bridge or ridge, symbol A, 7a may be replaced by symbol A, 7b.~~

~~(c) To give warning of a dip, symbol A, 7a may be replaced by symbol A, 7c.~~

A-07.1 gives warning of dips, hump bridges or ridges, or of sections where the carriageway is in bad condition.

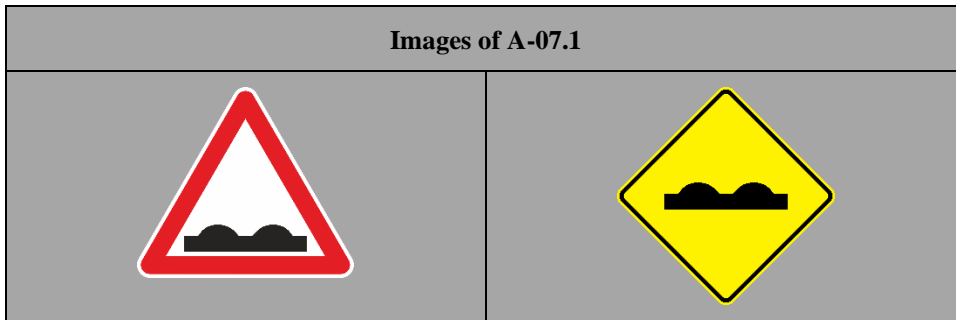

SPEED HUMP

A-07.2 gives warning of a speed hump.

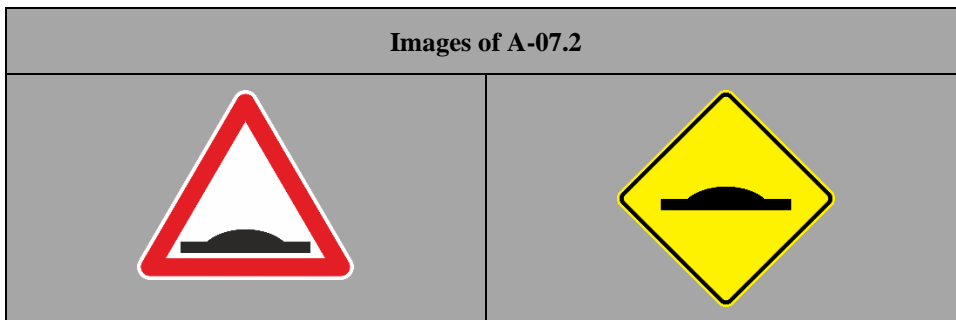

DIP

A-07.3 gives warning of a dip.

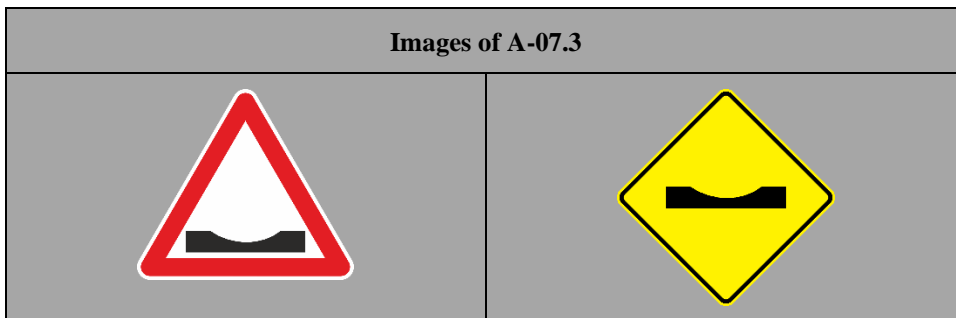

8. Dangerous shoulders

DANGEROUS SHOULDERS

~~(a) Warning of a section of road where the shoulders are particularly dangerous shall be given by symbol A, 8.~~

~~(b) The symbol may be reversed.~~

A-08.0 gives warning of a section of road where the shoulders are particularly dangerous. The symbol on this sign may be reversed.

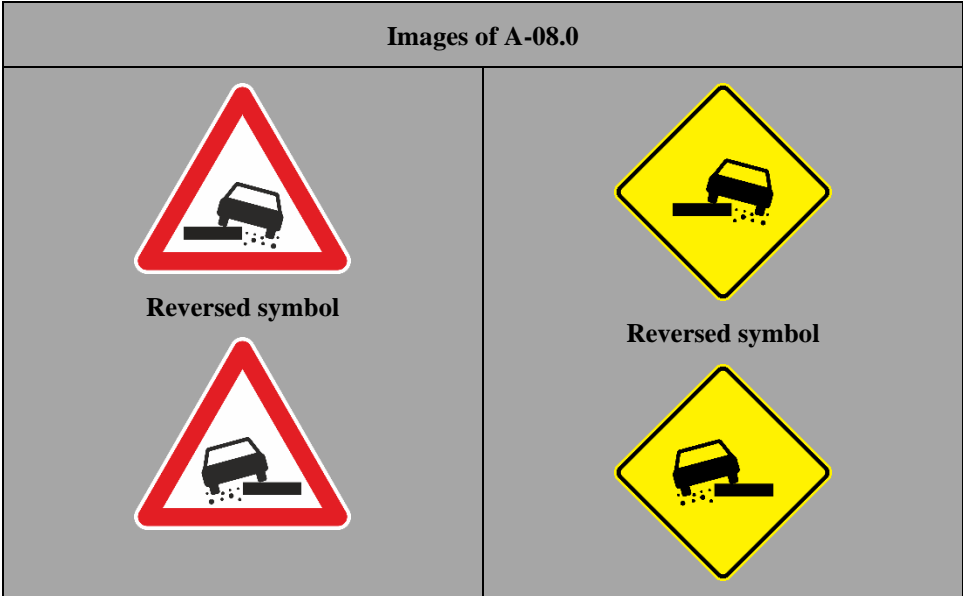

9. Slippery road

SLIPPERY ROAD

~~Warning that the section of road ahead may be particularly slippery shall be given by symbol A, 9~~

A-09.0 gives warning that the section of road ahead may be particularly slippery.

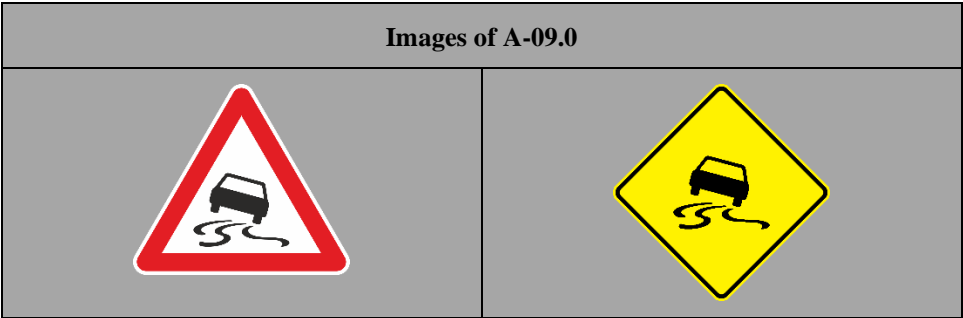

10. Loose gravel

LOOSE GRAVEL

~~Warning of a section of road on which gravel may be thrown up shall be given by symbol A, 10a used with the sign of model Aa or by symbol A, 10b with the sign of model Ab.~~

A-10.0 gives warning of a section of road on which gravel may be thrown up. The symbol on this sign may be reversed.

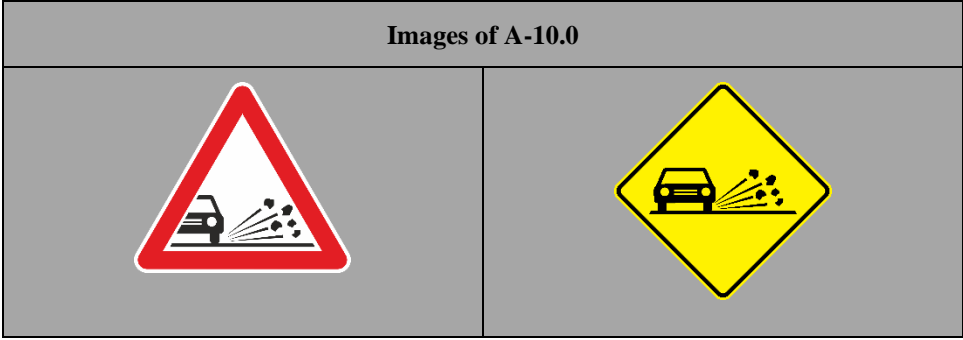

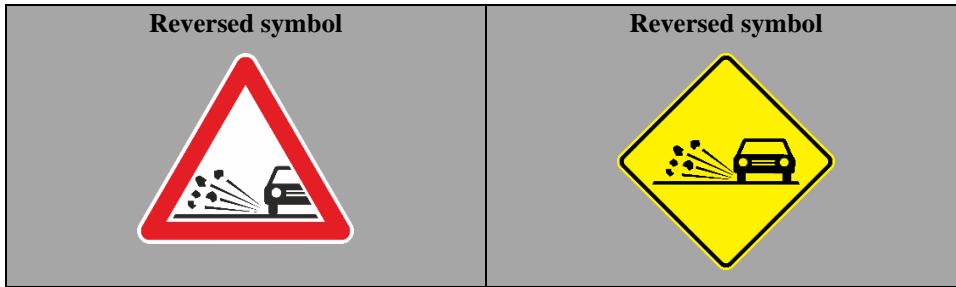

11. Falling rocks

FALLING ROCKS

(a) ~~Warning of a section of road on which there is danger from falling rocks and the consequent presence of rocks on the carriageway shall be given by symbol A, 11a used with the sign of model Aa or by symbol A, 11b with the sign of model Ab.~~

(b) ~~The right hand part of the symbol shall occupy the right hand corner of the sign panel in both cases.~~

(c) ~~The symbol may be reversed.~~

A-11.0 gives warning of a section of road on which there is danger from falling rocks and the consequent presence of rocks on the carriageway. The symbol on this sign may be reversed.

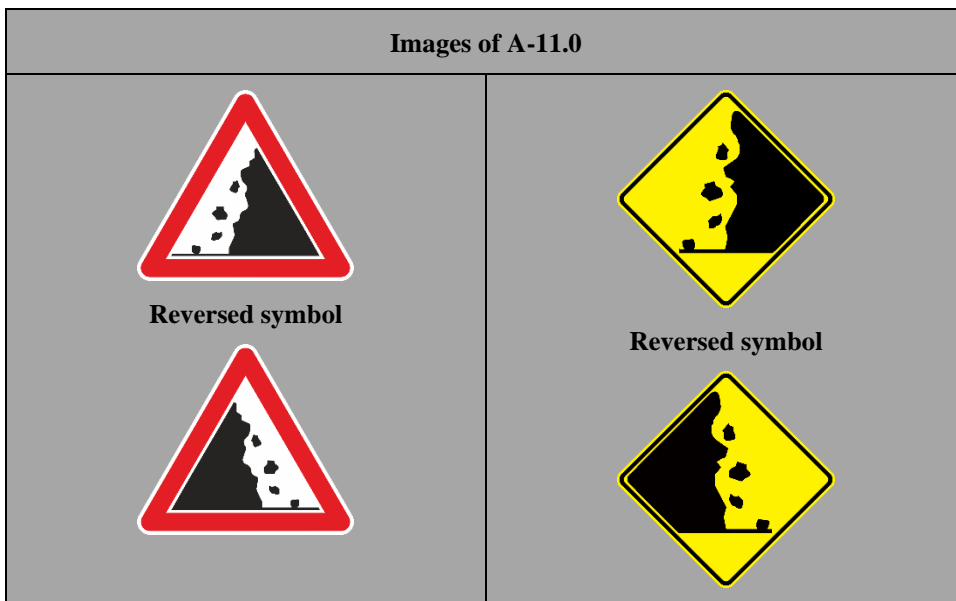

12. Pedestrians crossing

(a) ~~Warning of a pedestrian crossing indicated either by road markings, or by signs E, 12 shall be given by symbol A, 12 of which there are two models: A, 12a and A, 12b.~~

(b) ~~The symbol may be reversed.~~

PEDESTRIAN CROSSING

A-12.1 gives warning of a pedestrian crossing indicated either by road markings of broad stripes parallel to the axis of the carriageway, or by the sign E-10.0. The symbol on this sign may be reversed.

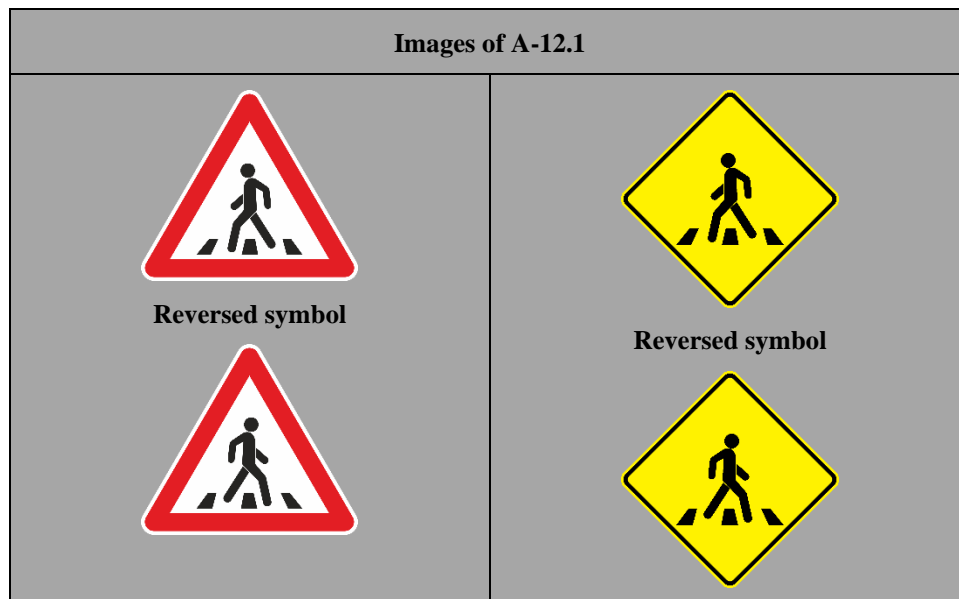

PEDESTRIANS

A-12.2 gives warning of a section of road frequented by pedestrians. The symbol on this sign may be reversed.

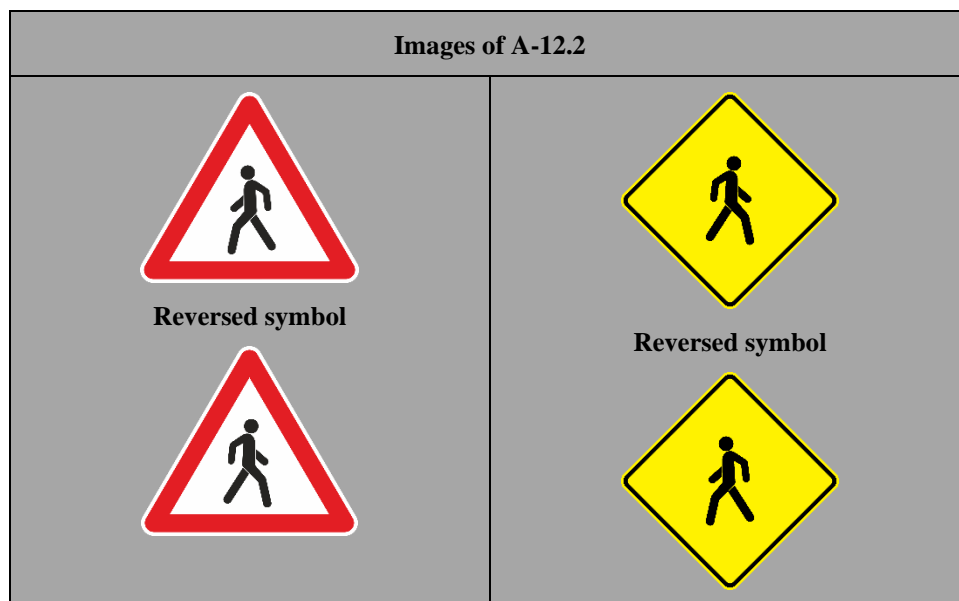

13. Children

(a) Warning of a section of road frequented by children, such as the exit from a school or playground shall be given by symbol A, 13.

(b) The symbol may be reversed.

CHILDREN

A-13.0 gives warning of a section of road frequented by children, such as in proximity of a school or playground. The symbol on this sign may be reversed.

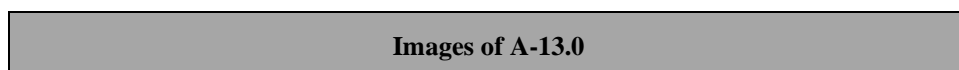

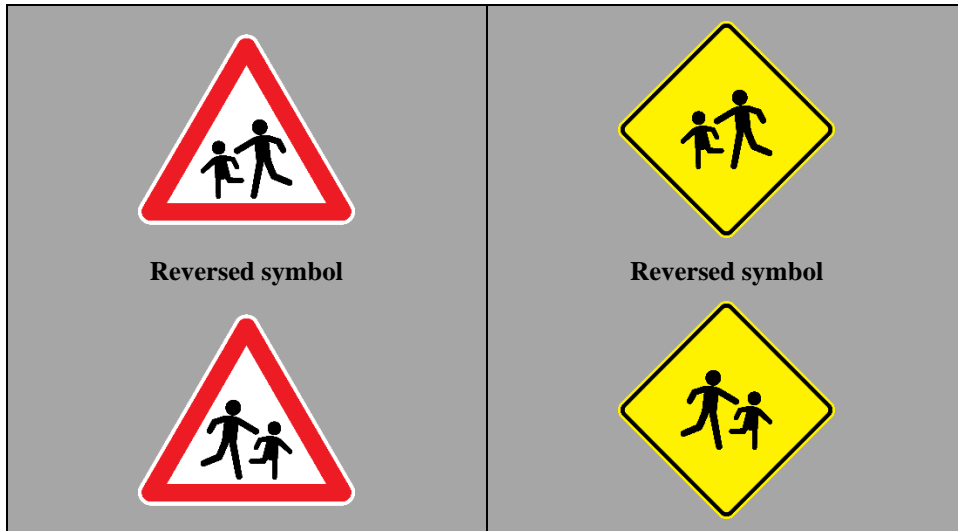

14. Cyclists entering or crossing

CYCLISTS ENTERING OR CROSSING

(a) ~~Warning of a point at which cyclists frequently enter or cross the road shall be given by symbol A, 14.~~

(b) ~~The symbol may be reversed.~~

A-14.0 gives warning of a point at which cyclists frequently enter or cross the road. The symbol on this sign may be reversed.

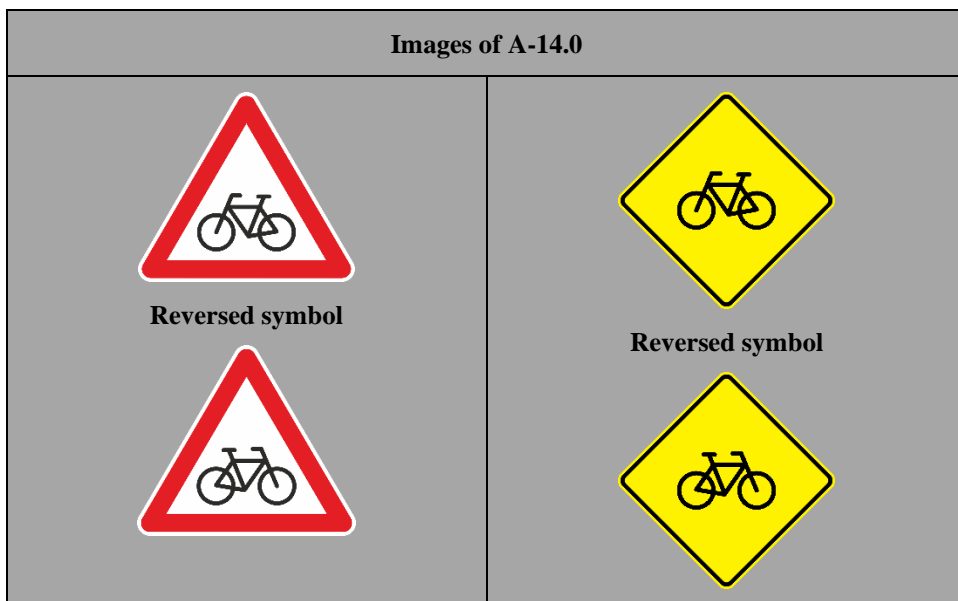

15. Cattle or other animals crossing

DOMESTIC ANIMALS CROSSING

(a) ~~Warning of a section of road on which there is a particular danger of animals crossing shall be given by a symbol representing the silhouette of the animal, domestic or wild, most frequently encountered, such as symbol A, 15a for a domestic animal and symbol A, 15b for a wild animal.~~

(b) ~~The symbol may be reversed.~~

A-15.1 gives warning of a section of road on which there is a particular danger of domestic animals crossing. The symbol shall represent the silhouette of the domestic animal most frequently encountered. The symbol on this sign may be reversed.

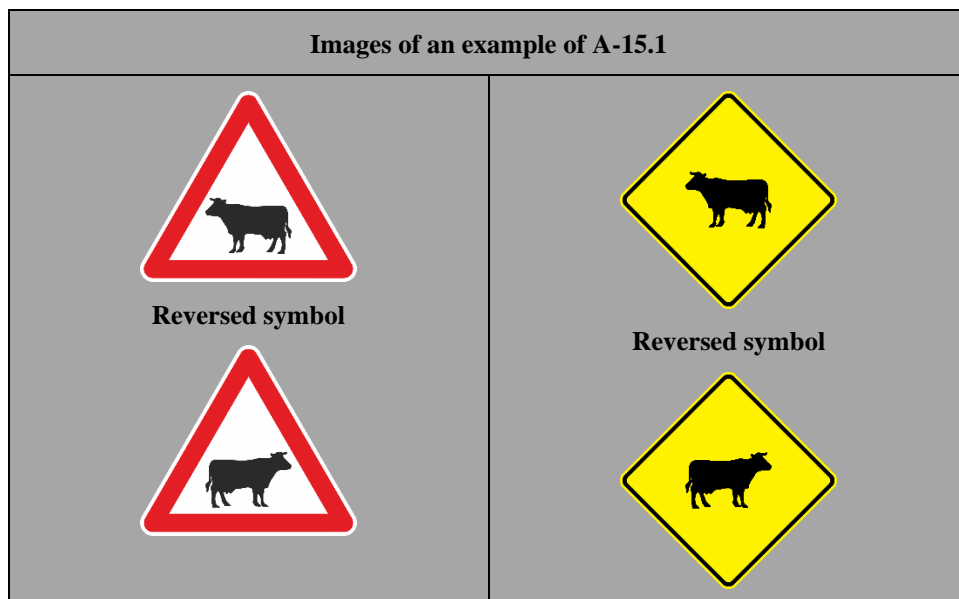

WILD ANIMALS CROSSING

A-15.2 gives warning of a section of road on which there is a particular danger of wild animals crossing. The symbol shall represent the silhouette of the wild animal most frequently encountered. The symbol on this sign may be reversed.

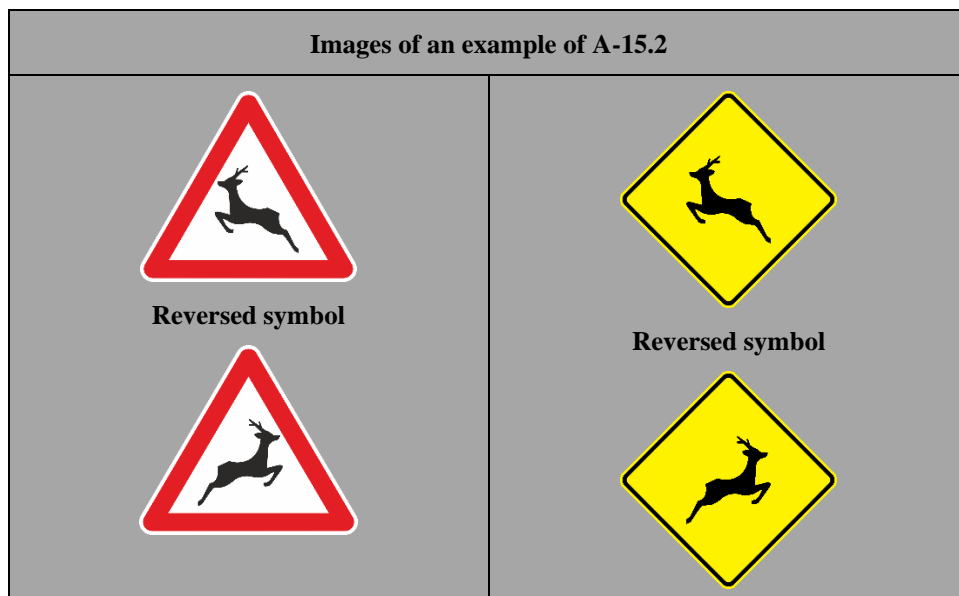

16. Road works

ROAD WORKS

Warning that work is in progress on the section of the road ahead shall be given by symbol A, 16.

A-16.0 gives warning that work is in progress on the section of the road ahead.

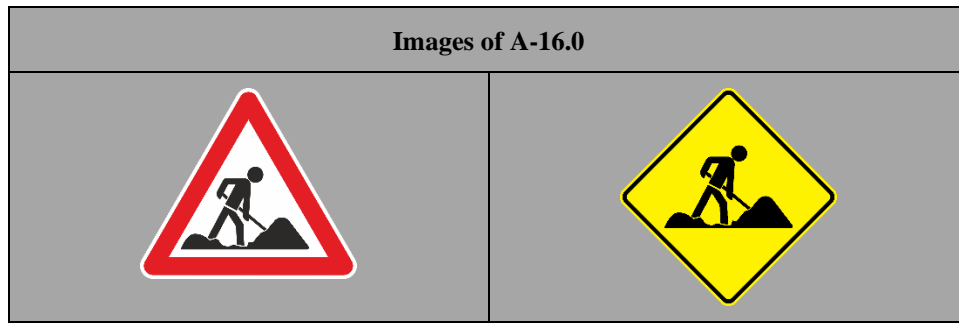

17. Traffic Light signals

TRAFFIC LIGHT SIGNALS

(a) If it is considered essential to give warning of a section of road on which traffic is regulated by three colour light signals, because road users would not expect such a section, symbol A, 17 shall be used. There are three models of symbol A, 17: A, 17a; A, 17b; and A, 17c, which correspond to the arrangements of lights in the three colour system described in Article 23, paragraphs 4 to 6 of this Convention.

(b) This symbol shall be in the three colours of the lights of which it gives warning.

A-17.0 gives warning of a section of road on which traffic is regulated by three-colour traffic light signals. The symbol shall be in the three colours of the traffic lights of which it gives warning. These three colours shall be surrounded by a dark colour narrow strip.

This sign shall only be used on road sections on which road users would not expect traffic light signals.

This sign may supplement or replace the signs A-18.1, A-18.2, A-19.1, A-19.2, and A-20.0 if traffic at the intersection is regulated by a traffic light signal.

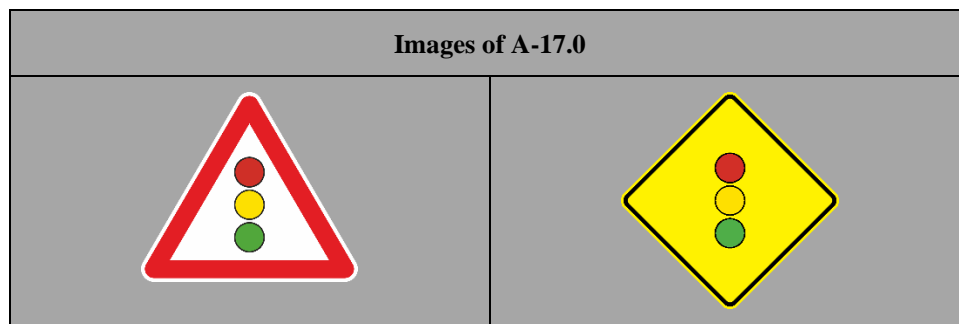

18. Intersection where the priority is prescribed by the general priority rule

INTERSECTION WITH GENERAL PRIORITY RULE

(a) Warning of an intersection where the priority is that prescribed by the general priority rule in force in the country shall be given by symbol A, 18a used with sign Aa or by symbol A, 18b used with sign Ab.

A-18.1 gives warning of an intersection where the priority is that prescribed by the general priority rule in force in the country.

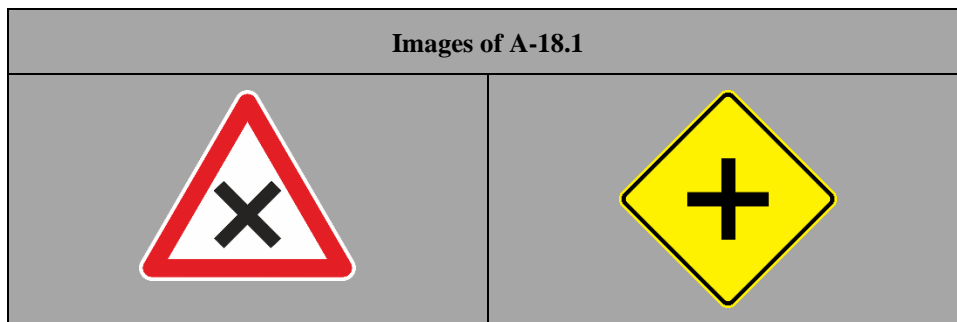

(b) Symbols A, 18a and A, 18b may be replaced by symbols which show the nature of the intersection more clearly, such as A, 18c; A, 18d; A, 18e; A, 18f and A, 18g.

A-18.2 gives warning of an intersection where the priority is that prescribed by the general priority rule in force in the country and shows an example of a specific nature of the intersection.

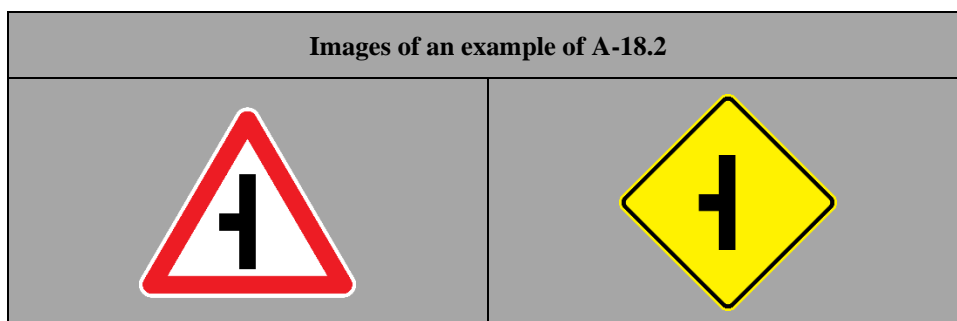

19. Intersection with a road the users of which must give way

(a) ~~Warning of an intersection with a road the users of which must give way shall be given by symbol A, 19a.~~

INTERSECTION WITH A GIVE WAY ROAD

A-19.1 gives warning of an intersection with a road the users of which must give way.

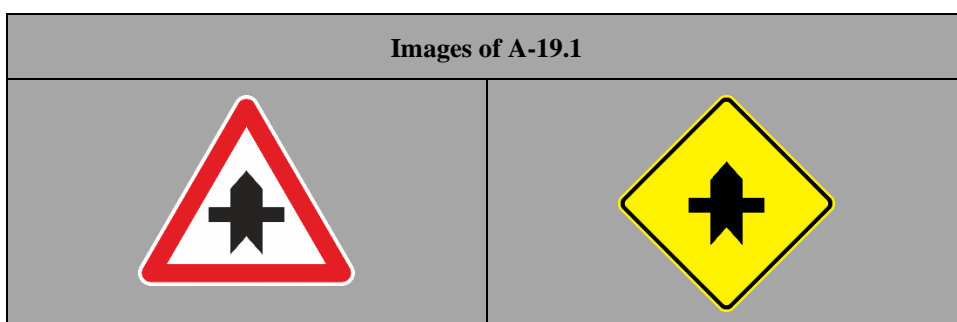

(b) ~~Symbol A, 19a may be replaced by symbols which show the nature of the intersection more clearly, such as A, 19b and A, 19c.~~

A-19.2 gives warning of an intersection with a road the users of which must give way and depicts an example of a specific nature of the intersection.

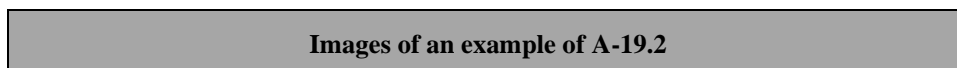

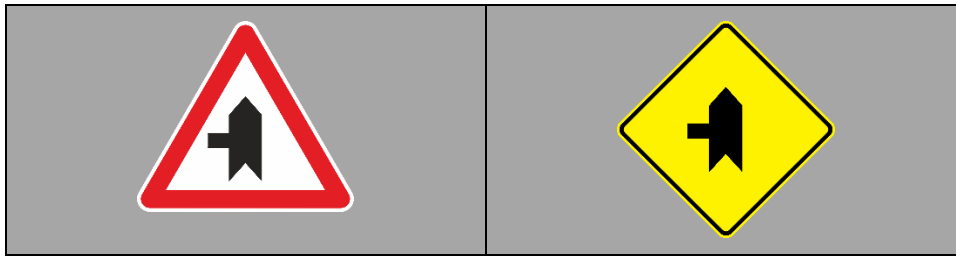

~~(e) These symbols~~ **The signs A-19.1 and A-19.2** may be used on a road only if sign ~~B, 1~~ or sign ~~B, 2~~ **B-01.0 or sign B-02.0** is placed on the road or roads with which it forms the intersection of which warning is given, or if these roads are such (for example, paths or earth-tracks) that, under domestic legislation, drivers using them are required to give way at the intersection even in the absence of such signs. The use of these symbols on roads on which sign ~~B, 3~~ **B-03.1** is set up shall be confined to certain exceptional cases.

~~20.~~ Intersection with a road to whose users drivers must give way

~~(a) If the "GIVE WAY" sign B, 1 is placed at the intersection, the symbol A, 20 shall be used at the approach.~~

~~(b) If the "STOP" sign B, 2 is placed at the intersection, the symbol used at the approach shall be A, 21a or A, 21b whichever corresponds to the model of sign B, 2 set up. (c) However, instead of sign Aa with these symbols, sign B, 1 or sign B, 2 may be used in conformity with Article 10, paragraph 6, of this Convention.~~

~~21~~20. Roundabout

ROUNDABOUT

~~Warning of a roundabout shall be given by symbol A, 22.~~

A-20.0 gives warning of a roundabout. The symbol on this sign shall be reversed for traffic keeping to the left.

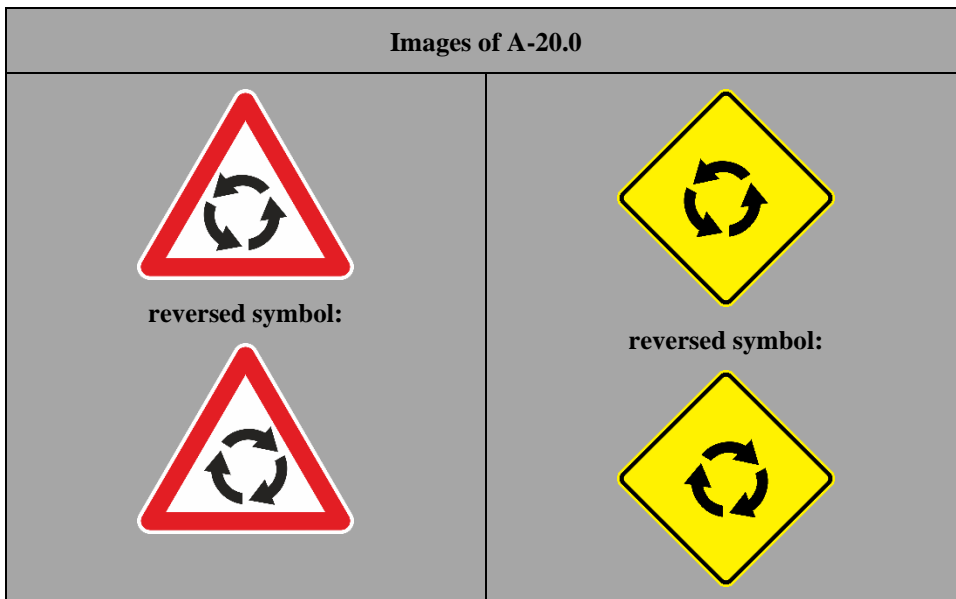

~~22.~~ Intersection where traffic is regulated by a light signal

~~If traffic at the intersection is regulated by a light signal, a sign Aa or Ab, bearing symbol A, 17 described in paragraph 17 above may be set up to supplement or replace the signs described in paragraphs 18 to 21 above.~~

2321. Two-way traffic**TWO-WAY TRAFFIC**

~~(a) Warning of a section of road temporarily or permanently carrying two-way traffic on the same carriageway when, on the previous section, traffic was carried on a one-way road or on a road comprising several one-way traffic carriageways, shall be given by the symbol A, 23.~~

~~(b) The sign bearing this symbol shall be repeated at the beginning of the section and along the section as frequently as may be necessary.~~

A-21.0 gives warning that the section of road will temporarily or permanently carry two-way traffic on the same carriageway, whereas the previous section carried one-way traffic. This sign shall be repeated at the beginning of the section and along the section as frequently as may be necessary. The symbol on this sign shall be reversed for traffic keeping to the left.

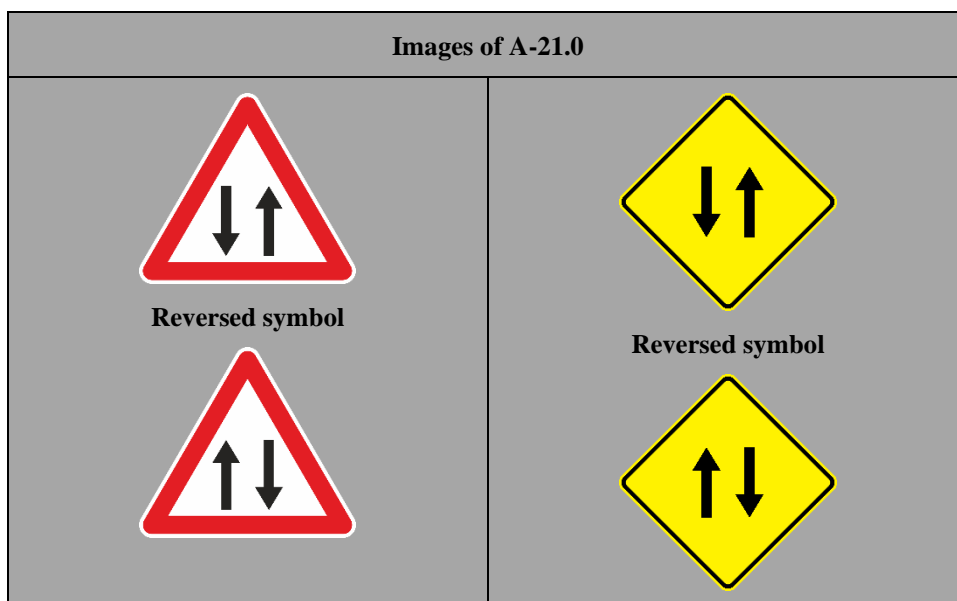
24 22. Traffic congestion**TRAFFIC CONGESTION**

~~(a) Warning that there may be traffic congestion on the section of road ahead shall be given by symbol A, 24.~~

~~(b) The symbol may be reversed.~~

A-22.0 gives warning that traffic may be congested on the section of road ahead. The symbol on this sign may be reversed for traffic keeping to the left.

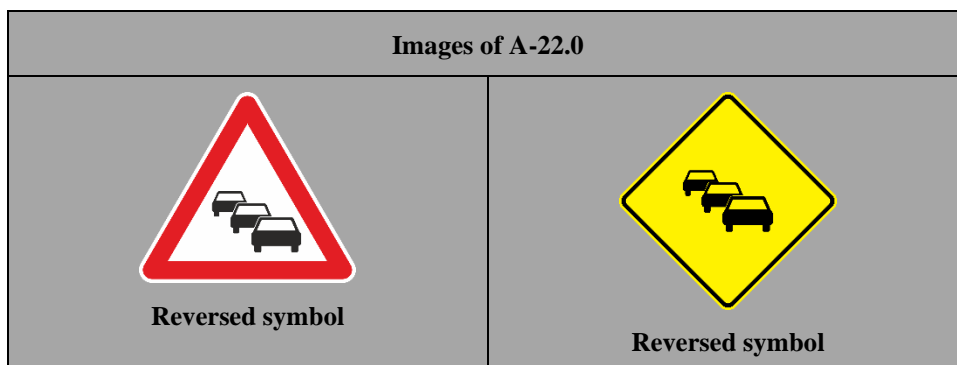

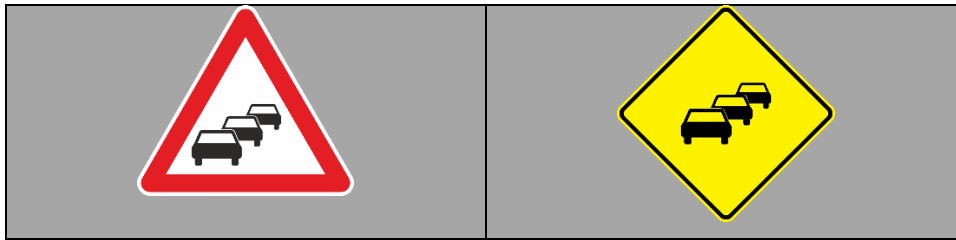

25 23. Level crossings ~~Level crossings with gates~~

LEVEL CROSSINGS WITH GATES

Warning of level crossings with gates or staggered half gates on either side of the railway line, shall be given by symbol A, 25.

A-23.1 gives warning of a level crossing with gates or staggered half-gates on either side of the railway. The symbol on this sign may be reversed. The barrier shown on the sign may be of the colours applied by a State concerned in accordance with Article 35, paragraph 1 of this Convention.

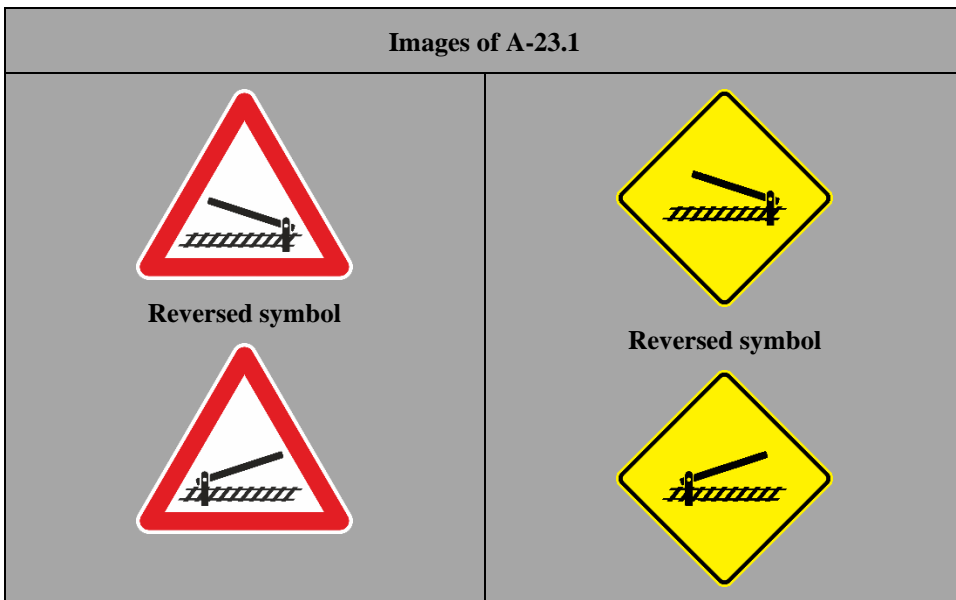

26 24. Other level crossings ~~level crossings~~

OTHER LEVEL CROSSINGS

Warning of other level crossings shall be given by symbol A, 26 a or A, 26 b, or by symbol A, 27 as appropriate.

A-23.2 gives warning of a level crossing without gates or staggered half-gates on either side of the railway. It may be replaced by sign A-23.3 or A-24.0. The symbol on this sign may be reversed for traffic keeping to the left.

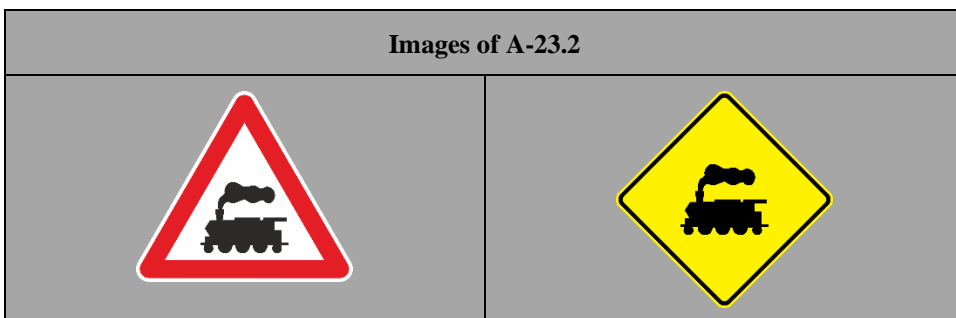

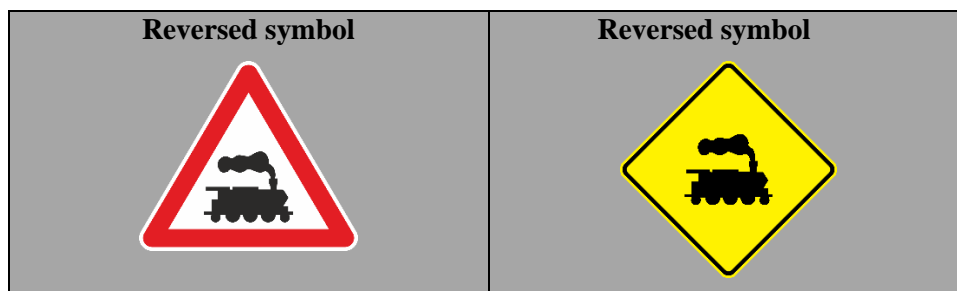

A-23.3 gives warning of a level crossing without gates or staggered half-gates on either side of the railway. It may be replaced by sign A-23.2 or A-24.0.

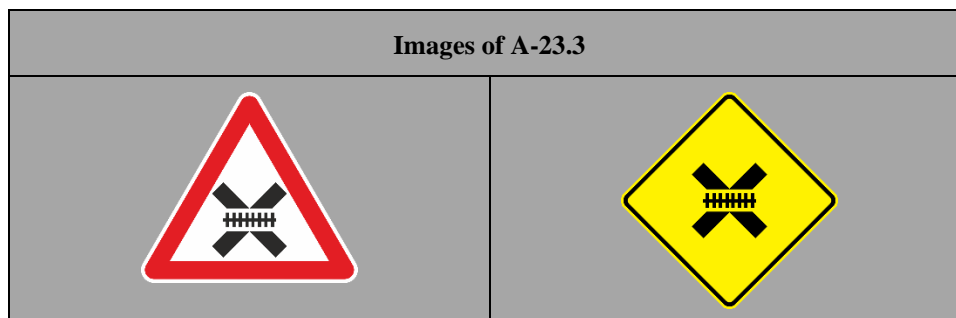

27 25. Intersection with a tramway line

INTERSECTION WITH A TRAMWAY

~~To give warning of an intersection with a tramway line, unless such intersection is a level crossing as defined in Article 1 of the Convention, symbol A, 27 may be used.~~

A-24.0 gives warning of an intersection with a tramway, unless such intersection is a level crossing as defined in Article 1 of the Convention. The symbol on this sign may be reversed for traffic keeping to the left. If the intersection is a level crossing, this sign may be replaced by sign A-23.2 or A-23.3.

NOTE—If it is considered necessary to give warning of intersections between a road and a railway track at which rail traffic proceeds very slowly and road traffic is regulated by a railwayman accompanying the railway vehicles and making the necessary hand signals, sign A, 32 described in paragraph 32 below shall be used.

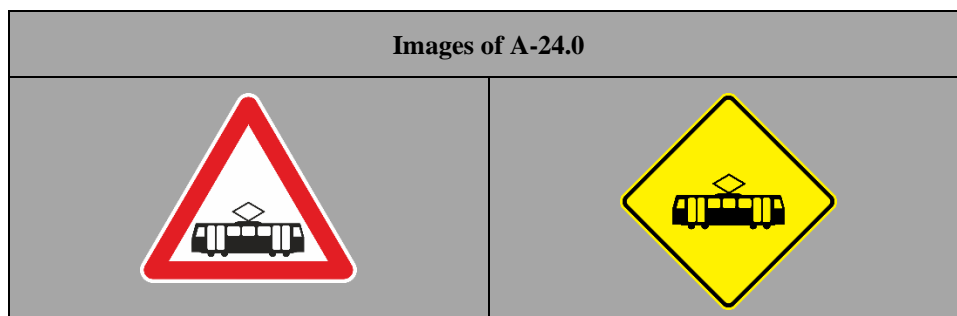

28 26. Signs to be placed in the immediate vicinity of ~~level crossings~~ a level crossing

LEVEL CROSSINGS

(a) — There are three models of sign A, 28 referred to in Article 35, paragraph 2 of this Convention: A, 28 a, A, 28 b, and A, 28 c.

(b) — Models A, 28 a and A, 28 b shall have a white or yellow ground and a red or black border; model A, 28 c shall have a white or yellow ground and a black border; the inscription on model A, 28 c shall be in black letters. Model A, 28 b shall be used only if the railway line comprises at least two tracks; with model A, 28 c the additional panel shall be affixed only if the line comprises at least two tracks, in which case it shall indicate the number of tracks.

(c) The normal length of the arms of the cross shall be not less than 1.20 m. If sufficient space is not available, the sign may be placed with its points directed upwards and downwards.

A-25.1 gives warning of the immediate vicinity of a level crossing with one track. It is of an X-shaped cross with a white or yellow ground and with a red or black border or may show red stripes (with or without a red or black border). This sign may be replaced by sign A-25.2.



A-25.2 gives warning of the immediate vicinity of a level crossing with one track. It is of an X-shaped cross with a white or yellow ground and with a black border and black inscriptions. This sign may be replaced by sign A-25.1.

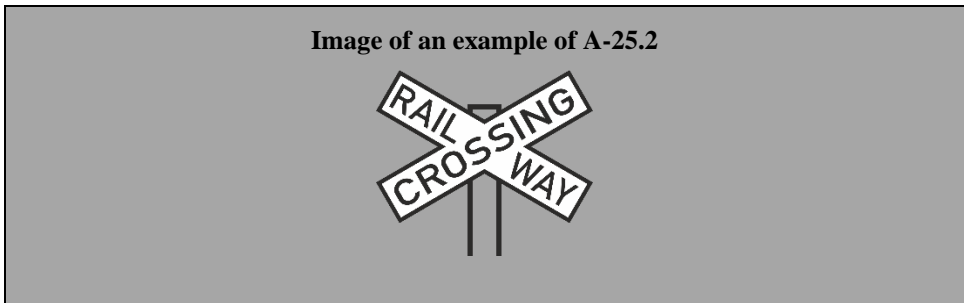

A-25.3 gives warning of the immediate vicinity of a level crossing with at least two tracks. It is identical to the sign A-25.1 except that it is supplemented by half of an X-shaped cross affixed below. It may be replaced by sign A-25.4.

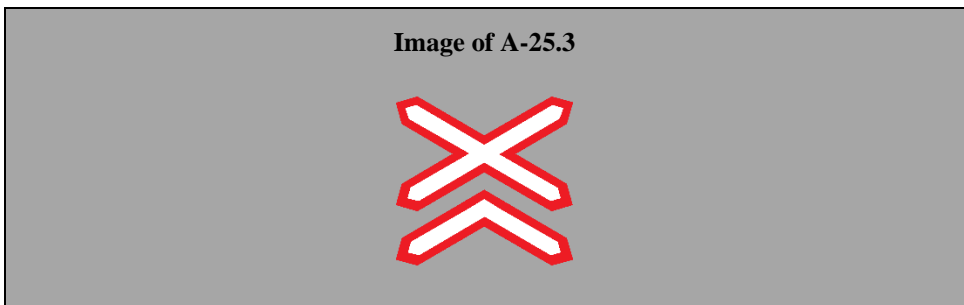

A-25.4 gives warning of the immediate vicinity of a level crossing with at least two tracks. It is identical to the sign A-25.2 except that it is

supplemented by an additional panel affixed below indicating the number of tracks. It may be replaced by sign A-25.3.

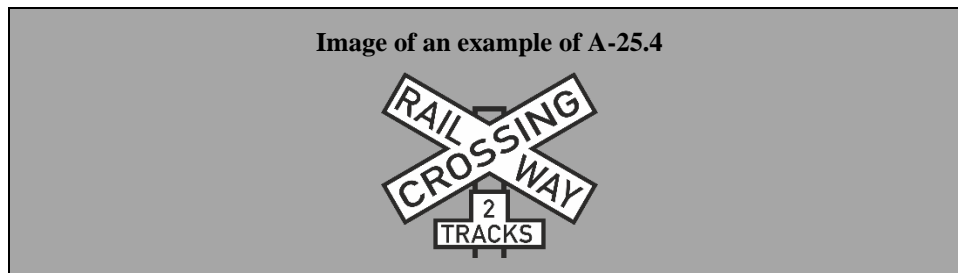

If a Contracting Party uses the sign A-25.1 at a level crossing with one track, the Contracting Party shall use the sign A-25.3 at a level crossing with at least two tracks, or alternatively use signs A-25.2 and A-25.4.

~~29 27. Additional signs at approaches to level crossings~~ **level crossings or swing opening bridges**

APPROACHES TO LEVEL CROSSINGS OR OPENING BRIDGES

(a) — Signs A, 29a, A, 29b and A, 29c may be used to give warning of and distance at approaches to level crossings and swing bridges. These signs are rectangular having its longer sides vertical and bear respectively three, two and one oblique red stripes on a white or yellow ground, with the latter two signs set up at about two thirds and one third of the distance between the sign A, 29a and the railway line or swing bridge. These signs may be repeated on the opposite side of the carriageway. The stripes shall slope downwards towards the carriageway.

(b) — The danger warning sign for the level crossing or swing bridge may be placed above signs A, 29b and A, 29c in the same way as it shall be placed above sign A, 29a.

A-26.1 gives warning of and distance at approaches to level crossings and opening bridges. It shall be placed under the signs A-23.1, A-23.2, A-23.3, A-24.0 and A-05.0. The sign is a rectangle with longer vertical sides and bears, preferably centred, three oblique red stripes on a white or yellow ground. It may be repeated on the opposite side of the carriageway. The stripes shall slope downwards towards the carriageway.

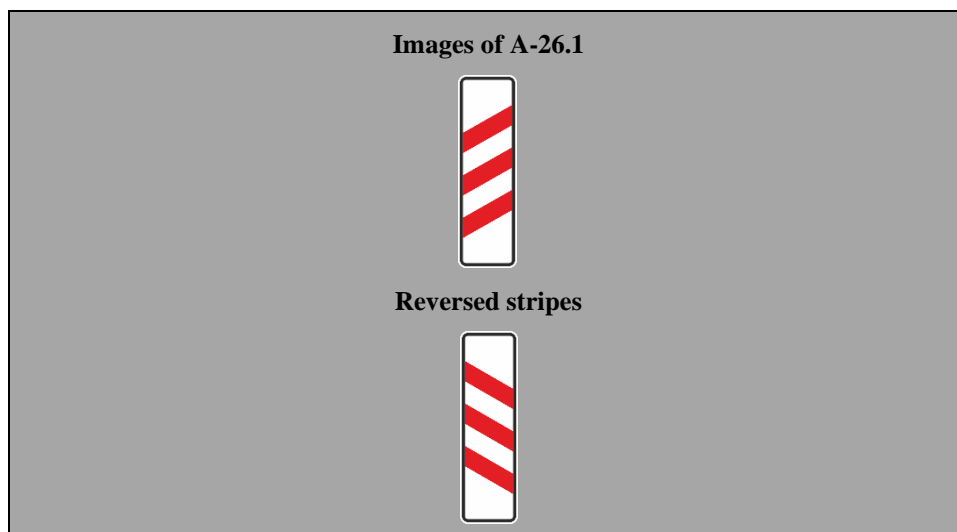

A-26.2 gives warning of and distance at approaches to level crossings and opening bridges. It may be placed under the signs A-23.1, A-23.2, A-23.3, A-24.0 and A-05.0. The sign is a rectangle with longer vertical sides and bears, preferably centred, two oblique red stripes on a white or yellow

ground. The sign is placed at about two-thirds of the distance between the railway or the opening bridge and the sign A-26.1. It may be repeated on the opposite side of the carriageway. The stripes shall slope downwards towards the carriageway.

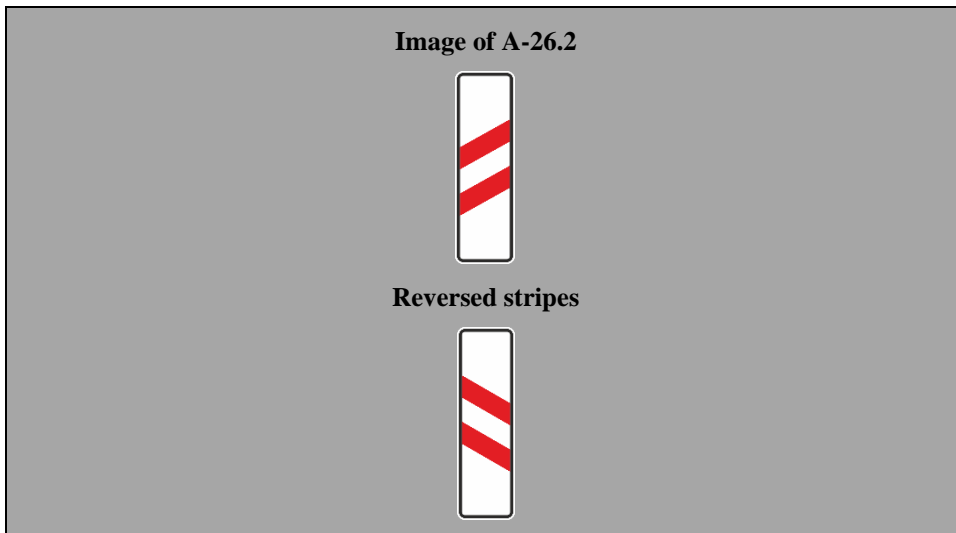

A-26.3 gives warning of and distance at approaches to level crossings and opening bridges. It may be placed under the signs A-23.1, A-23.2, A-23.3, A-24.0 and A-05.0. The sign is a rectangle with longer vertical sides and bears, preferably centred, one oblique red stripe on a white or yellow ground. The sign is placed at about one-third of the distance between the railway or opening bridge and the sign A-26.1. It may be repeated on the opposite side of the carriageway. The stripe shall slope downwards towards the carriageway.

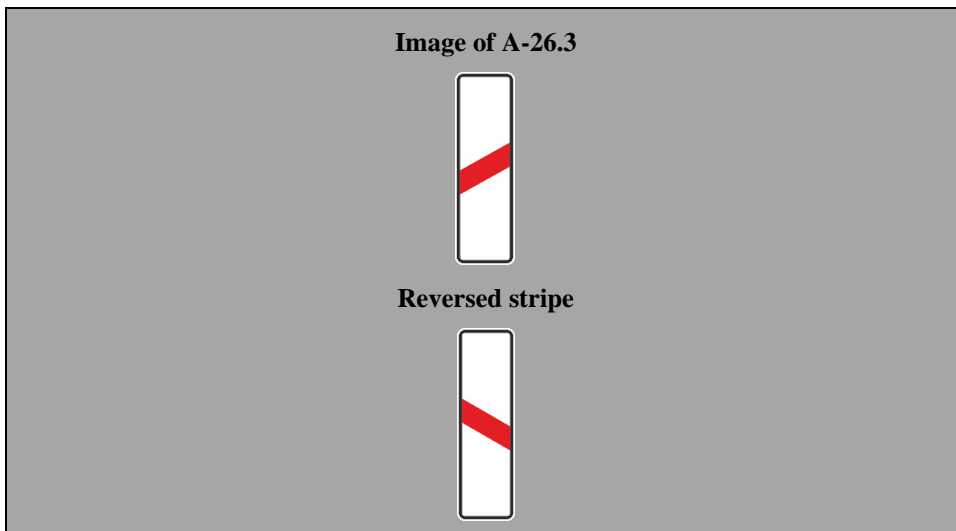

~~30~~ **28. Airfield**

~~(a) Warning of a section of road likely to be flown over at low altitude by aircraft taking off from or landing on an airfield shall be given by symbol A-30.~~

~~(b) The symbol may be reversed.~~

AIRFIELD

A-27.0 gives warning of a section of road that is in the vicinity of low flying aircraft that are taking off from or landing on an airfield.

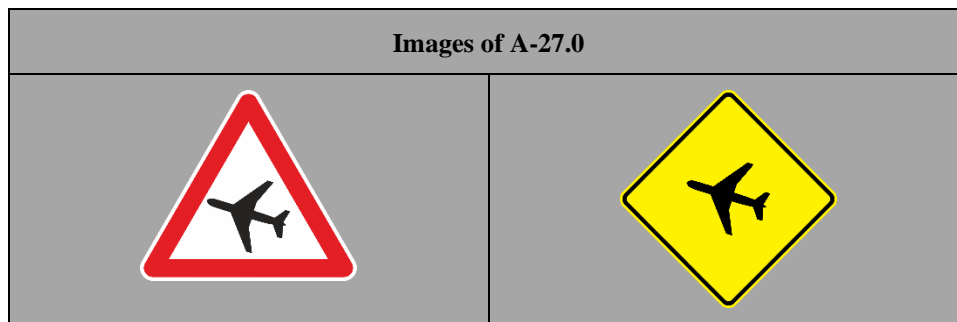

31 29. Cross-wind

CROSS-WIND

(a) ~~Warning of a section of road on which there is often a strong cross wind shall be given by symbol A, 31.~~

(b) ~~The symbol may be reversed.~~

A-28.0 gives warning of a section of road on which there is often a strong cross-wind. The symbol on this sign may be reversed.

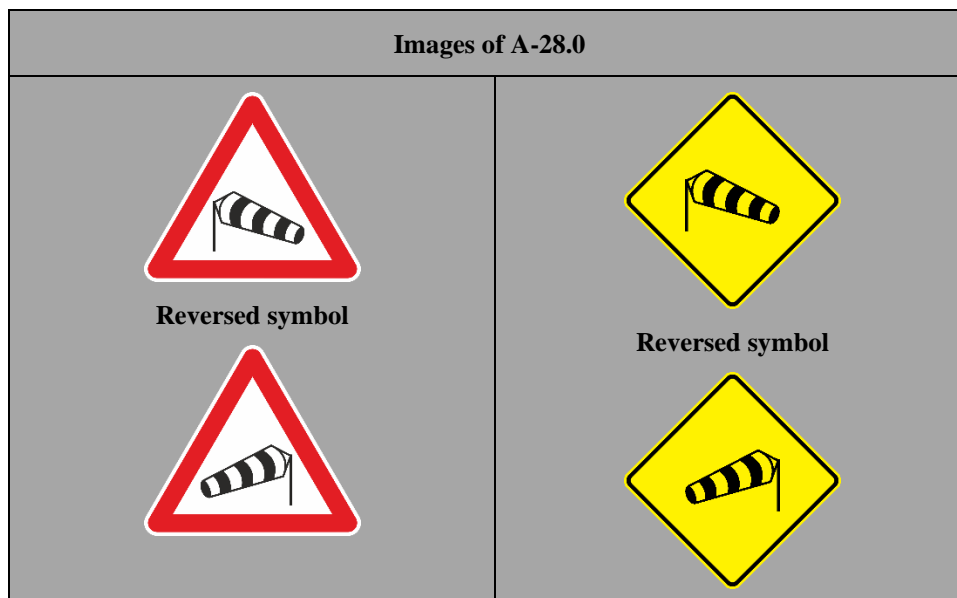

32 30. Other dangers

OTHER DANGERS

(a) ~~Warning of a section of road on which there is a danger other than those enumerated in paragraphs 1 to 31 above or in section B of this annex may be given by symbol A, 32.~~

A-29.0 gives warning of a section of road on which there is a danger other than those enumerated above or in section B of this Annex.

(b) It shall, however, be open to Contracting Parties to adopt graphic symbols in conformity with the provisions of Article 3, paragraph 1 (a) (ii) of this Convention.

(c) ~~Sign A, 32 may be used, in particular, to give warning of intersections with railway tracks at which rail traffic proceeds very slowly and road traffic is regulated by a railwayman accompanying the railway vehicles and making the necessary hand signals.~~

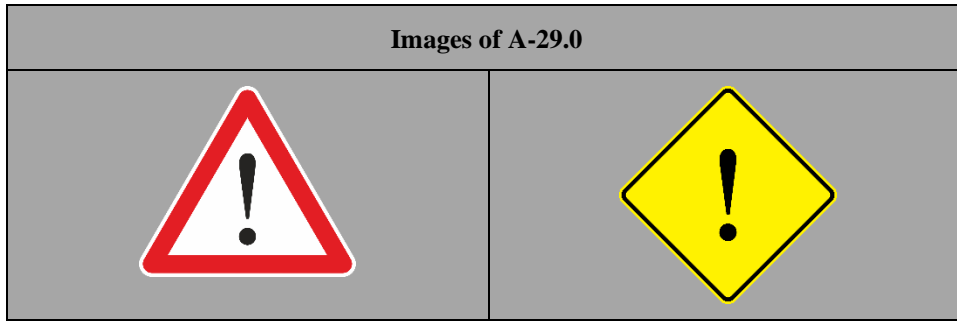

Section B

PRIORITY SIGNS

~~NOTE— At an intersection comprising a priority road in which there is a bend, an additional panel H, 8 bearing a diagram of the intersection which shows the outline of the priority road may be placed below danger signs giving warning of the intersection or below priority signs, whether they are set up at the intersection or not.~~

Definitions, images, and characteristics

1. “GIVE WAY” Give way sign

~~(a) — The "GIVE WAY" sign shall be sign B, 1. It shall consist of an equilateral triangle having one side horizontal and the opposite vertex below it. The ground shall be white or yellow and the border red. The sign shall bear no symbol.~~

GIVE WAY

B-01.0 notifies drivers that, at the intersection where the sign is placed, they must give way to vehicles on the road they are approaching. The sign shall consist of an equilateral triangle having one side horizontal and the opposite vertex below it. The ground shall be white or yellow with a red border. The sign shall not bear a symbol.

(b) — The side of the normal sized sign shall measure approximately 0.90 m; the side of the small sign shall measure not less than 0.60 m.

B-01.0 may be used in conjunction with an additional panel H-08.0 described in section H, subsection II, paragraph 5 of this Annex, that indicates to drivers the outline of the priority road.

To give warning that sign B-01.0 is placed at an intersection, sign B-01.0 supplemented by an additional panel H-01.0, described in section H, subsection II, paragraph 1 of this Annex, shall be used at the approach by Contracting Parties using model one for danger warning signs. If a Contracting Party uses model two for danger warning signs, the sign B-01.0 shall be depicted on the panel of model two for danger warning signs.

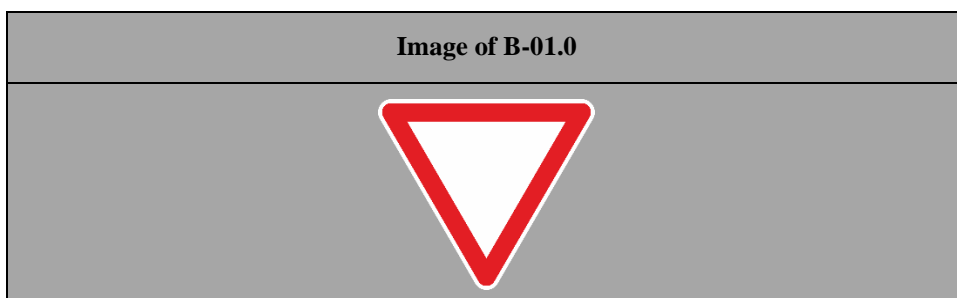

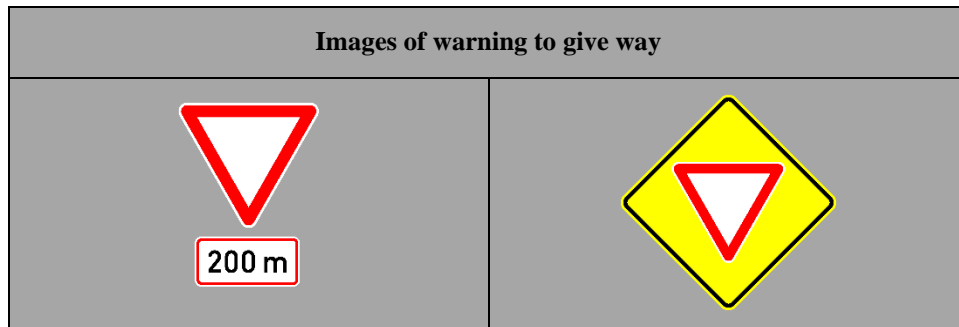

2. "STOP" Stop sign

(a) — The "STOP" sign shall be sign B, 2, of which there are two models:

(i) — Model B, 2a is octagonal with a red ground bearing the word "STOP" in white in English or in the language of the State concerned; the height of the word shall be not less than one third of the height of the panel;

(ii) — Model B, 2b is circular with a white or yellow ground and a red border; it bears within it sign B, 1 without any inscription, and near the top, in large letters, the word "STOP" in black or dark blue, in English or in the language of the State concerned.

STOP

B-02.0 notifies drivers that, at the intersection where the sign is placed, they must stop before entering the intersection and give way to vehicles on the road they are approaching. The sign is an octagon with a red ground surrounded by a white rim and bears the "STOP" inscription in white in English or in the language of the State concerned. The height of the inscription shall not be less than one-third of the height of the panel.

(b) The height of the normal sized sign B, 2a **B-02.0** and the diameter of the normal sized sign B, 2b shall be approximately 0.90 m; the same dimensions of the small signs **and** shall be not less than 0.60 m **for a small sized sign**.

(c) — As regards the choice between models B, 2a and B, 2b, see Article 5, paragraph 2, and Article 10, paragraph 3, of this Convention.

B-02.0 may be used in conjunction with an additional panel H-08.0, described in section H, subsection II, paragraph 5 of this Annex, that indicates to drivers the outline of the priority road.

To give warning that sign B-02.0 is placed at an intersection, sign B-01.0 supplemented by an additional panel bearing the "STOP" inscription, or its equivalent in the national language and a figure indicating the distance to the sign B-02.0 shall be used at the approach by Contracting Parties using model one for danger warning signs. Shall a Contracting Party use model two for danger warning signs, sign B-02.0 shall be depicted on the panel of model two for danger warning signs.



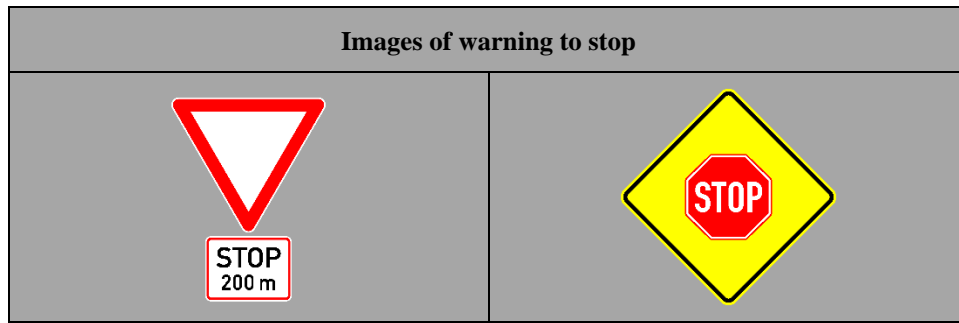

3. “PRIORITY ROAD” Priority road sign

PRIORITY ROAD

(a) ~~The “PRIORITY ROAD” sign shall be sign B,3. B-03.1 notifies drivers that, at intersections with other roads, they have priority over vehicles moving along or coming from the other roads. ‡ The sign shall consist of a square with one diagonal vertical. The rim of the sign shall be black; the sign shall have in its centre a yellow or orange square with a black rim; the space between the two squares shall be white.~~

(b) ~~The side of the normal sized sign shall measure approximately 0.50 m; the side of the small sign shall measure not less than 0.35 m.~~

B-03.1 may be used in conjunction with an additional panel H-08.0, described in section H, subsection II, paragraph 5 of this Annex, that indicates the outline of the priority road to drivers.

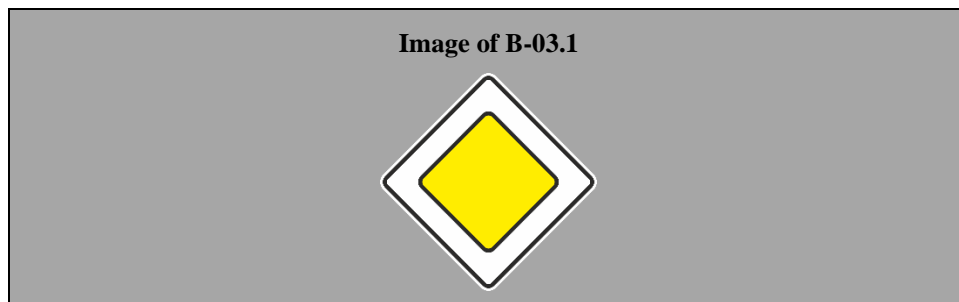

4. “END OF PRIORITY ROAD” End of priority sign

END OF PRIORITY ROAD

(a) ~~The “END OF PRIORITY” sign shall be sign B, 4. B-03.2 notifies drivers that the road along which they are moving ceases to have priority over other roads. ‡ The sign shall consist of sign B, 3 B-03.1 above with the addition of a black or grey median band perpendicular to the lower left and upper right sides of the square or, preferably, of grey black parallel lines forming such a band.~~

B-03.2 may be used in conjunction with an additional panel H-08.0 described in section H, subsection II, paragraph 5 of this Annex, that indicates the outline of the priority road to drivers.

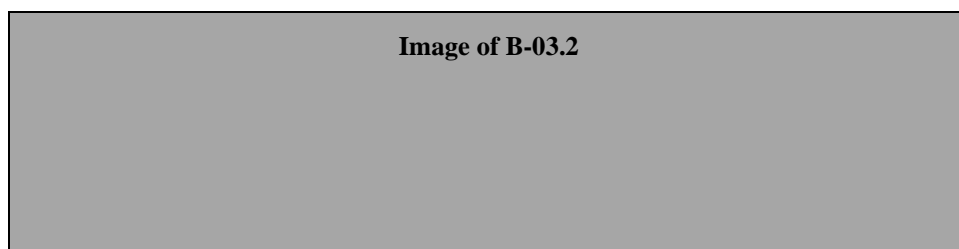

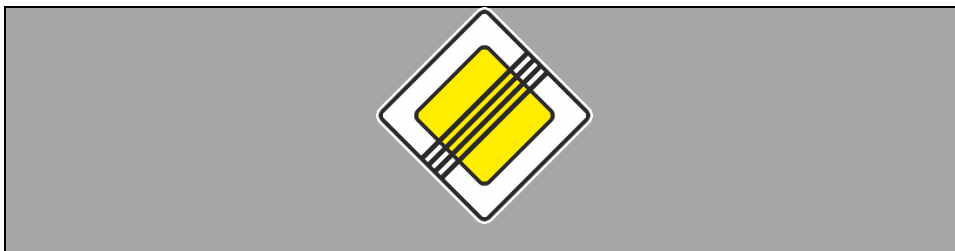

5. Sign indicating priority for oncoming traffic

PRIORITY FOR ONCOMING TRAFFIC

(a) If, on a narrow section of road where passing is difficult or impossible, traffic is regulated and if, because drivers can see the whole length of the section clearly both at night and by day, such regulation is carried out by giving priority to traffic moving in one direction and not by installing traffic light signals, sign B, 5 "PRIORITY FOR ONCOMING TRAFFIC" shall be set up facing the traffic on the side which does not have priority. This sign shall mean that entry into the narrow section is prohibited so long as it is not possible to pass through that section without obliging oncoming vehicles to stop.

B-04.1 notifies drivers that entry into the narrow section is prohibited so long as it is not possible to pass through that section without obliging the oncoming vehicles to stop. The sign shall be used on a narrow section of road where passing is difficult or impossible and where drivers can see the whole length of the section clearly both at night and by day, and no traffic light signals are installed. The sign shall be set up facing the traffic on the side which does not have priority. The symbol on this sign shall be reversed for traffic keeping to the left.

(b) This sign shall be round, with a white or yellow ground and **with** a red border; the arrow indicating the direction having priority shall be black and that indicating the other direction red. **The arrows shall be parallel.**

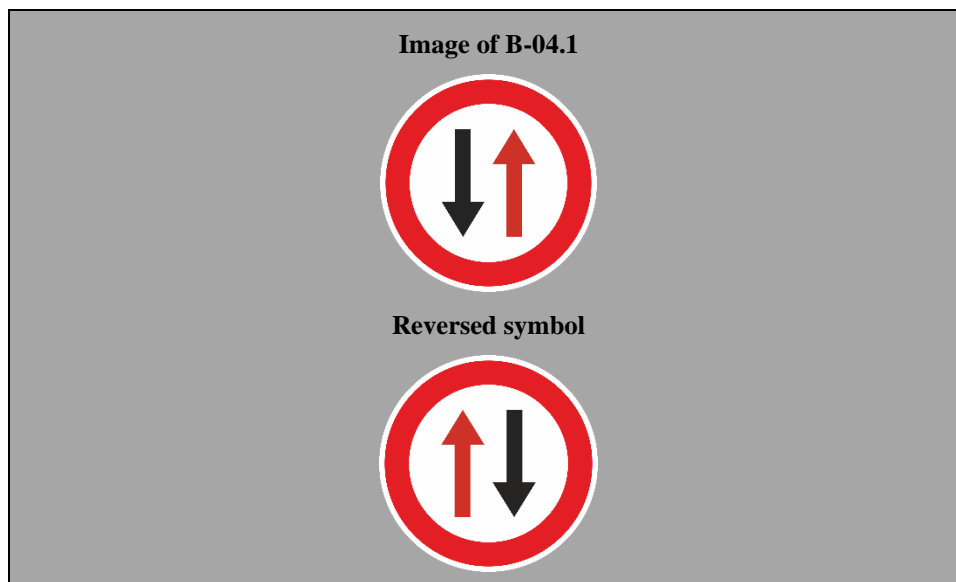

B-04.2 notifies drivers that entry into the narrow section is prohibited so long as it is not possible to pass through that section without obliging oncoming vehicles to stop. It shall be used on a narrow section of road where passing is difficult or impossible and where drivers can see the whole length of the section clearly both at night and by day, and no traffic light signals are installed. The sign shall be set up facing the traffic on the side which does not have priority. The symbol on this sign shall be reversed for traffic keeping to the left.

The sign shall be round, with a white or yellow ground and with a red border; the arrow indicating the direction having priority shall be black and that indicating the other direction red. The arrowheads shall be joining one another at the centre of this sign. This sign may be used instead of sign B-04.1 taking into account as far as possible the provisions of Article 5, paragraph 2 (b) of this Convention.

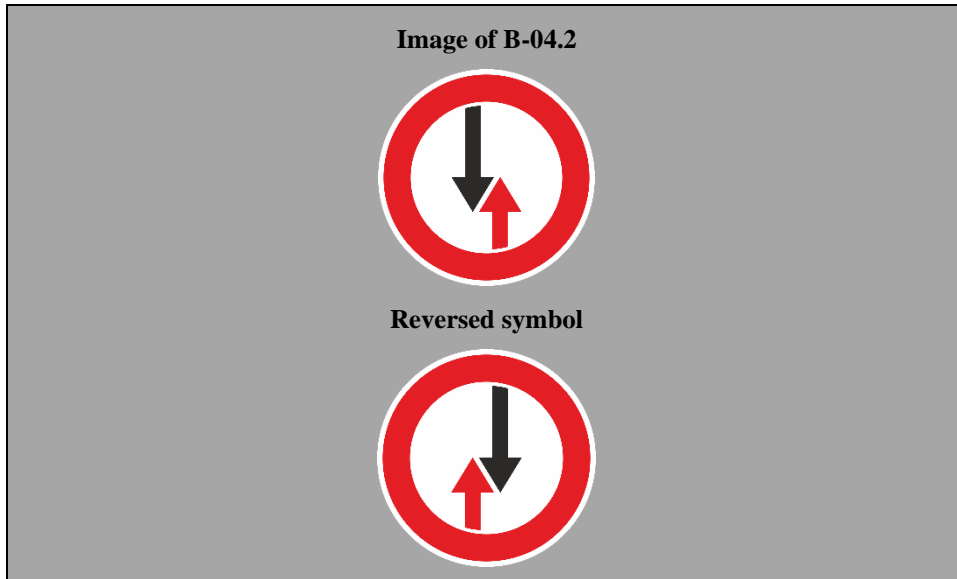

6. Sign indicating priority over oncoming traffic

PRIORITY OVER ONCOMING TRAFFIC

~~(a) To notify drivers that on a narrow section of road they have priority over oncoming vehicles the sign used shall be B, 6.~~

~~(b) This sign shall be rectangular with a blue ground; the arrow pointing upwards shall be white and the other arrow red.~~

~~(c) When sign B, 6 is used, a sign B, 5 shall be placed on the road, at the other end of the narrow section, for traffic moving in the opposite direction.~~

B-05.1 notifies drivers of entry into a narrow section where they have priority over oncoming vehicles. The sign shall be used on a narrow section of road where passing is difficult or impossible and where drivers can see the whole length of the section clearly both at night and by day, and no traffic light signals are installed. The sign shall be set up facing the traffic on the side which has priority. The symbol on this sign shall be reversed for traffic keeping to the left.

This sign shall be rectangular with a blue ground; the arrow pointing upwards shall be white and the other arrow red. The arrows shall be parallel. When sign B-05.1 is used, the sign B-04.1 shall be placed on the road, at the other end of the narrow section, for traffic moving in the opposite direction.

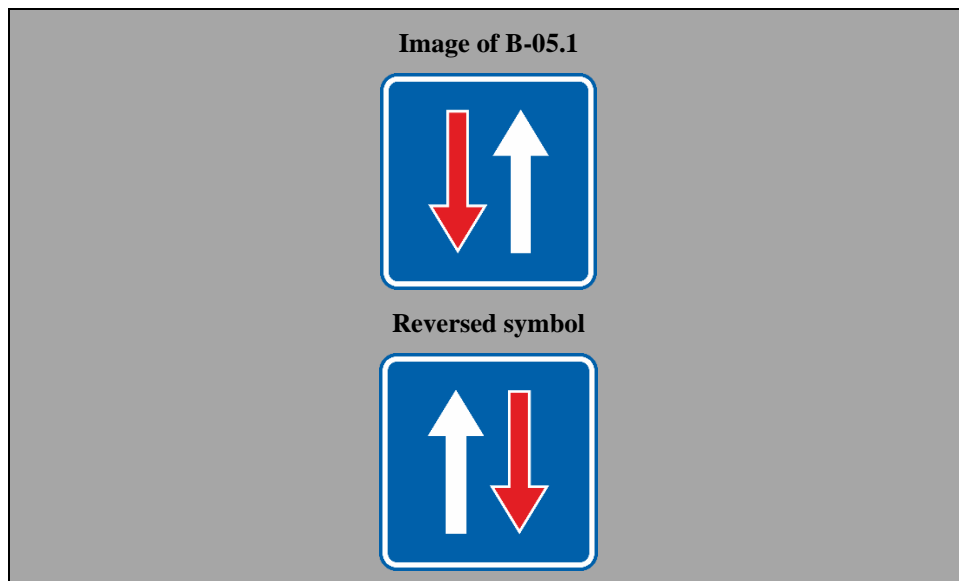

B-05.2 notifies drivers of entry into a narrow section where they have priority over oncoming vehicles. The sign shall be used on a narrow section of road where passing is difficult or impossible and where drivers can see the whole length of the section clearly both at night and by day, and no traffic light signals are installed. The sign shall be set up facing the traffic on the side which has priority. The symbol on this sign shall be reversed for traffic keeping to the left.

The sign shall be rectangular with a blue ground; the arrow pointing upwards shall be white and the other arrow red. The arrows shall be joining one another at the centre. When the sign B-05.2 is used, the sign B-04.2 shall be placed on the road, at the other end of the narrow section, for traffic moving in the opposite direction. This sign may be used instead of sign B-05.1 taking into account as far as possible the provisions of Article 5, paragraph 2 (b) of this Convention.

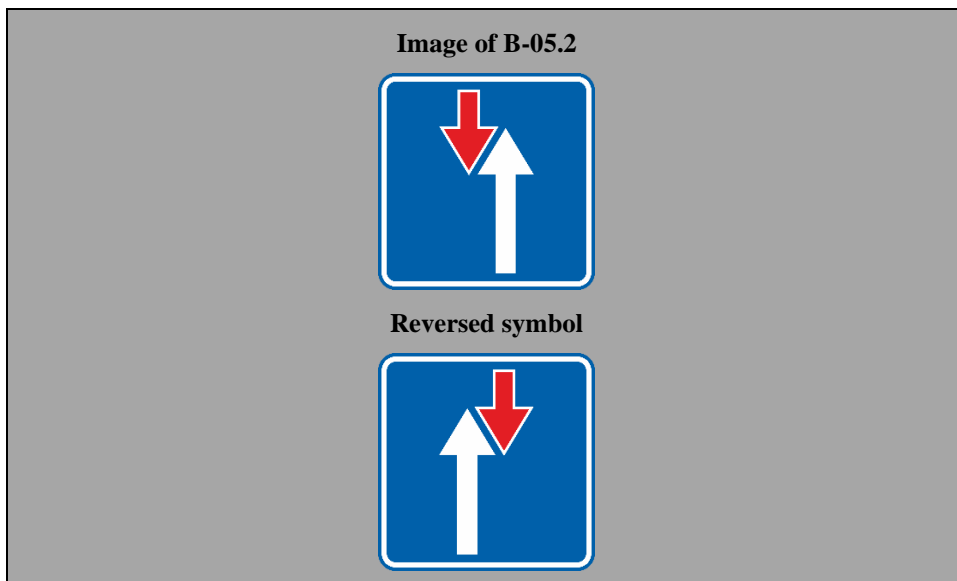

Section C

PROHIBITORY ~~OR~~ AND RESTRICTIVE SIGNS

I. General characteristics and symbols

1. Prohibitory and restrictive signs shall be circular; their diameter shall be not less than 0.60 m outside built-up areas and not less than 0.40 m or 0.20 m for signs prohibiting or restricting standing and parking in built-up areas.
2. Unless otherwise specified where the signs in question are described, prohibitory ~~or~~ and restrictive signs shall have a white or yellow ground or blue ground for signs prohibiting or restricting standing and parking with a wide red border; the symbols and the inscriptions, if any, shall be black or dark blue and the oblique bars, if any, shall be red and shall slope downwards from left to right regardless of the direction of traffic. Conversely, bands used to end a regulation shall slope downwards from right to left regardless of the direction of driving in the country.
3. **Contracting Parties may omit the red oblique bar from signs C-03.1 to C-03.14 and C-04.1 and C-04.2.**

II. ~~Descriptions~~ Definitions and images

1. Prohibition and restriction of entry

(a) Notification that entry is prohibited for all vehicles shall be given by sign C, 1, "NO ENTRY", of which there are two models: C, 1a, and C, 1b.

NO ENTRY

C-01.1 notifies that entry is prohibited for all vehicles. The sign may be replaced by sign C-01.2. The choice between C-01.1 or C-01.2 shall be made in accordance with Article 5, paragraph 2 of this Convention.

Image of C-01.1



C-01.2 notifies that entry is prohibited for all vehicles. The sign may be replaced by sign C-01.1. The choice between C-01.1 or C-01.2 shall be made in accordance with Article 5, paragraph 2 of this Convention.

Image of C-01.2



CLOSED TO ALL VEHICLES IN BOTH DIRECTIONS

~~(b) Notification that all vehicular traffic is prohibited in both directions shall be given by sign C, 2, "CLOSED TO ALL VEHICLES IN BOTH DIRECTIONS".~~

C-02.0 notifies that all vehicular traffic is prohibited in both directions.

Image of C-02.0



~~(c) Notification that entry is prohibited for a certain category of vehicle or road user only, shall be given by a sign bearing as a symbol the silhouette of the vehicles or road users whose entry is prohibited. Sign C, 3a; C, 3b; C, 3c; C, 3d; C, 3e; C, 3f; C, 3g; C, 3h; C, 3i; C 3j; C, 3k; and C, 3l shall have the following meanings:~~

~~C, 3a – NO ENTRY FOR ANY POWER DRIVEN VEHICLE EXCEPT TWO-WHEELED MOTOR CYCLES WITHOUT SIDE CAR~~

~~NO ENTRY FOR ANY POWER-DRIVEN VEHICLE WITH MORE THAN TWO WHEELS.~~

C-03.1 notifies that entry is prohibited for any power-driven vehicle with more than two wheels.

Image of C-03.1



~~C, 3b "NO ENTRY FOR MOTOR CYCLES"~~ **NO ENTRY FOR MOTOR CYCLES**

C-03.2 notifies that entry is prohibited for motor cycles.

Image of C-03.2



~~C, 3e "NO ENTRY FOR CYCLES"~~ **NO ENTRY FOR CYCLES**

C-03.3 notifies that entry is prohibited for cycles.

Image of C-03.3



~~C, 3d "NO ENTRY FOR MOPEDS"~~ **NO ENTRY FOR MOPEDS**

C-03.4 notifies that entry is prohibited for mopeds

Image of C-03.4



~~C, 3e "NO ENTRY FOR GOODS VEHICLES"~~ **NO ENTRY FOR GOODS VEHICLES**

C-03.5 notifies that entry is prohibited for goods vehicles

The inscription of a tonnage figure, either in a light colour on the silhouette of the vehicle or, in accordance with Article 8, paragraph 4 of this Convention, on an additional panel placed below **this** sign ~~C, 3e~~, shall mean that the prohibition applies only if the permissible maximum mass of the vehicle or combination of vehicles exceeds that figure.

Image of an example of C-03.5



~~C, 3f "NO ENTRY FOR ANY POWER DRIVEN VEHICLE DRAWING A TRAILER OTHER THAN A SEMI TRAILER OR A SINGLE AXLE TRAILER"~~ NO ENTRY FOR ANY POWER-DRIVEN VEHICLE DRAWING A TRAILER OTHER THAN A SEMI-TRAILER OR A SINGLE AXLE TRAILER

C-03.6 notifies that entry is prohibited for any power-driven vehicle drawing a trailer other than a semi-trailer or a single axle trailer.

The inscription of a tonnage figure, either in a light colour on the silhouette of the trailer or, in accordance with Article 8, paragraph 4, of this Convention, on an additional panel placed below **this** sign C, 3f, shall mean that the prohibition applies only if the permissible maximum mass of the trailer exceeds that figure. It shall be open to Contracting Parties, in cases where they see fit to do so, to replace, in the symbol, the silhouette of the rear end of a lorry by that of the rear end of a private car, and the trailer silhouette by that of a trailer which can be attached to a private car.

Image of an example of C-03.6



~~C, 3g "NO ENTRY FOR ANY POWER DRIVEN VEHICLE DRAWING A TRAILER"~~ NO ENTRY FOR ANY POWER-DRIVEN VEHICLE DRAWING A TRAILER

C-03.7 notifies that entry is prohibited for any power-driven vehicle drawing a trailer.

The inscription of a tonnage figure, either in a light colour on the silhouette of the trailer or, in accordance with Article 8, paragraph 4 of this Convention, on an additional panel placed below **this** sign C, 3g, shall mean that the prohibition applies only if the permissible maximum mass of the trailer exceeds that figure.

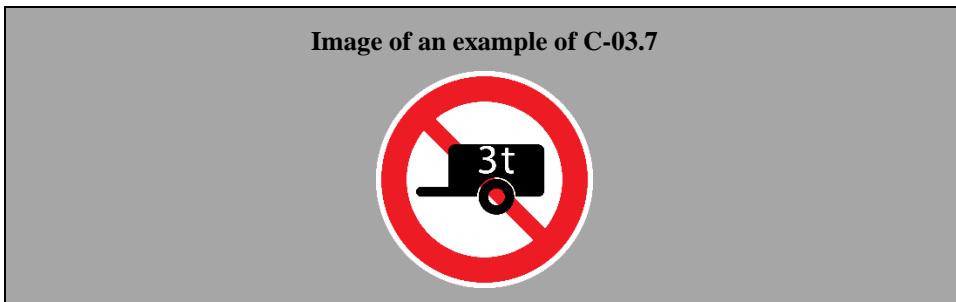

~~C, 3h "NO ENTRY FOR VEHICLES CARRYING DANGEROUS GOODS FOR WHICH SPECIAL SIGN PLATING IS PRESCRIBED"~~ **NO ENTRY FOR VEHICLES CARRYING DANGEROUS GOODS FOR WHICH SPECIAL SIGN PLATING IS PRESCRIBED**

C-03.8 notifies that entry is prohibited for vehicles carrying dangerous goods for which special sign plating is prescribed.

To indicate no entry for vehicles carrying certain types of dangerous goods, ~~the~~ **this** sign ~~C, 3h~~ may be used in conjunction, if necessary, with an additional panel. The information given on this additional panel specifies that this prohibition applies only to the carriage of dangerous goods as defined by domestic legislation.



~~C, 3i "NO ENTRY FOR PEDESTRIANS"~~ **NO ENTRY FOR PEDESTRIANS**

C-03.9 notifies that entry is prohibited for pedestrians.



~~C, 3j "NO ENTRY FOR ANIMAL-DRAWN VEHICLES"~~ **NO ENTRY FOR ANIMAL-DRAWN VEHICLES**

C-03.10 notifies that entry is prohibited for animal-drawn vehicles.

Image of C-03.10



~~C-3k "NO ENTRY FOR HANDCARTS"~~ NO ENTRY FOR HANDCARTS

C-03.11 notifies that entry is prohibited for handcarts.

Image of C-03.11



~~C-3l "NO ENTRY FOR POWER-DRIVEN AGRICULTURAL VEHICLES"~~
NO ENTRY FOR POWER-DRIVEN AGRICULTURAL VEHICLES

C-03.12 notifies that entry is prohibited for power-driven agricultural vehicles.

Image of C-03.12



NO ENTRY FOR VEHICLES CARRYING MORE THAN A CERTAIN
QUANTITY OF EXPLOSIVES OR READILY INFLAMMABLE
SUBSTANCES

C-03.13 notifies that entry is prohibited for vehicles carrying more than a certain quantity of explosives or readily inflammable substances.

Image of C-03.13



NO ENTRY FOR VEHICLES CARRYING MORE THAN A CERTAIN QUANTITY OF SUBSTANCES LIABLE TO CAUSE WATER POLLUTION

C-03.14 notifies that entry is prohibited for vehicles carrying more than a certain quantity of substances liable to cause water pollution.

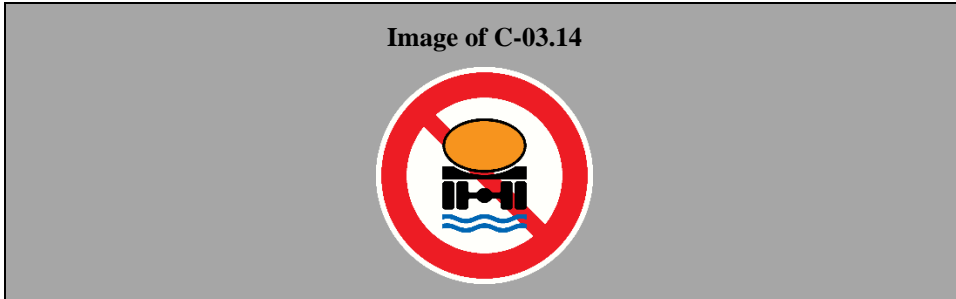

NOTE—It shall be open to Contracting Parties to omit from signs C, 3a to C, 3l the red oblique bar joining the upper left quadrant and the lower right quadrant or, provided that this does not make the symbol less easy to see and understand, not to interrupt the bar where it crosses the symbol.

(d) Notification that entry is prohibited for several categories of vehicle or road user, may be given either by displaying as many prohibitory signs as there are prohibited classes, or by a single prohibitory sign which shows the silhouettes of the various vehicles or road users whose entry is prohibited. Signs C, 4a "NO ENTRY FOR POWER DRIVEN VEHICLES"; and C, 4b "NO ENTRY FOR POWER DRIVEN VEHICLES OR ANIMAL DRAWN VEHICLES" are examples of such signs.

NO ENTRY FOR MORE THAN ONE CATEGORY OF VEHICLE OR ROAD USER

C-04.1 notifies that entry is prohibited for more than one category of vehicle or road user depicted on the sign.

Signs showing more than two silhouettes may not be set up outside built-up areas. Signs showing more than two silhouettes may not be set up outside built up areas. And signs showing more than three silhouettes may not be set up in built-up areas.

Contracting Parties may instead use separate signs, each depicting the specific category of vehicle or road user.

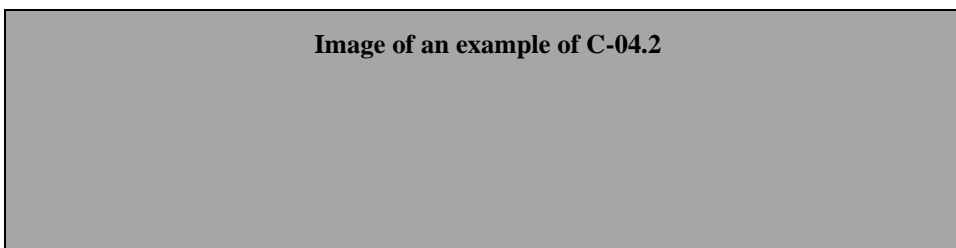
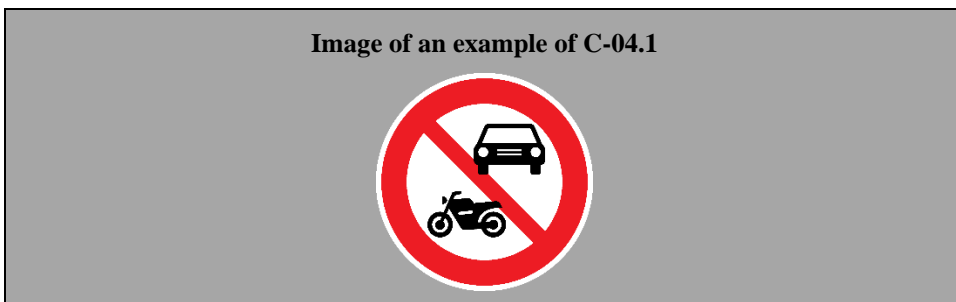

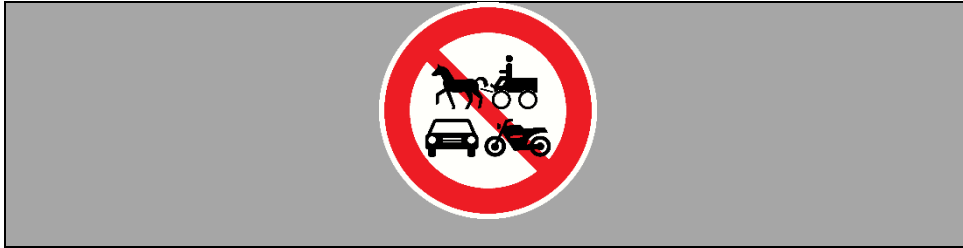

(e) Notification that entry is prohibited for vehicles whose mass or dimensions exceed certain limits shall be given by the signs:

~~C, 5 "NO ENTRY FOR VEHICLES HAVING AN OVERALL WIDTH EXCEEDING ... METRES"~~ **NO ENTRY FOR TOO WIDE VEHICLES**

C-05.1 notifies that entry is prohibited for vehicles having an overall width exceeding the indicated figure (in metres) on the sign.

Image of an example of C-05.1



C-05.2 notifies that entry is prohibited for vehicles having an overall width exceeding the indicated figure (in metres) with a decimal fraction on the sign. The decimal fraction shall be depicted with a "comma" or a "dot" depending on the indication of decimal fractions in the State concerned.

Image of an example of C-05.2



~~C, 6 "NO ENTRY FOR VEHICLES HAVING AN OVERALL HEIGHT EXCEEDING ... METRES"~~ **NO ENTRY FOR TOO HIGH VEHICLES**

C-06.1 notifies that entry is prohibited for vehicles having an overall height exceeding the indicated figure (in metres) on the sign.

Image of an example of C-06.1



C-06.2 notifies that entry is prohibited for vehicles having an overall height exceeding the indicated figure (in metres) with a decimal fraction

on the sign. The decimal fraction shall be depicted with a “comma” or a “dot” depending on the indication of decimal fractions in the State concerned.

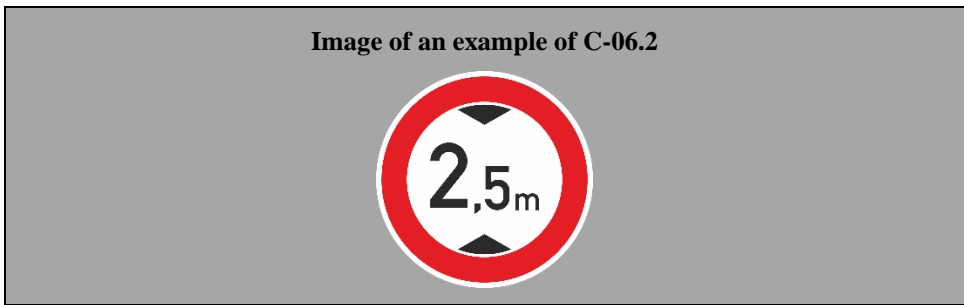

~~C, 7 "NO ENTRY FOR VEHICLES EXCEEDING ... TONNES LADEN MASS" NO ENTRY FOR TOO HEAVY VEHICLES~~

C-07.1 notifies that entry is prohibited for vehicles having a laden mass exceeding the indicated figure (in tonnes) on the sign.

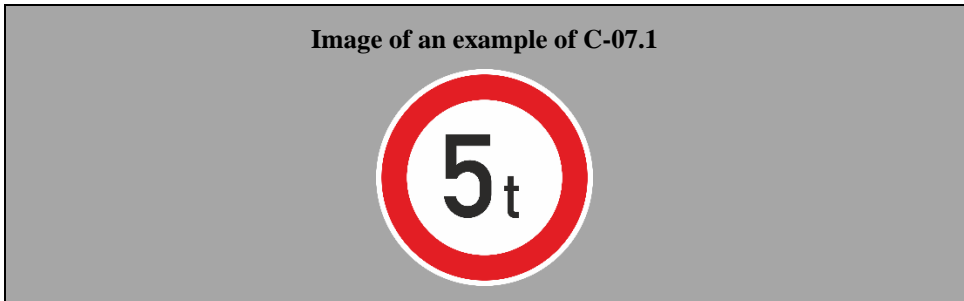

C-07.2 notifies that entry is prohibited for vehicles having a laden mass exceeding the indicated figure (in tonnes) with a decimal fraction on the sign. The decimal fraction shall be depicted with a “comma” or a “dot” depending on the indication of decimal fractions in the State concerned.

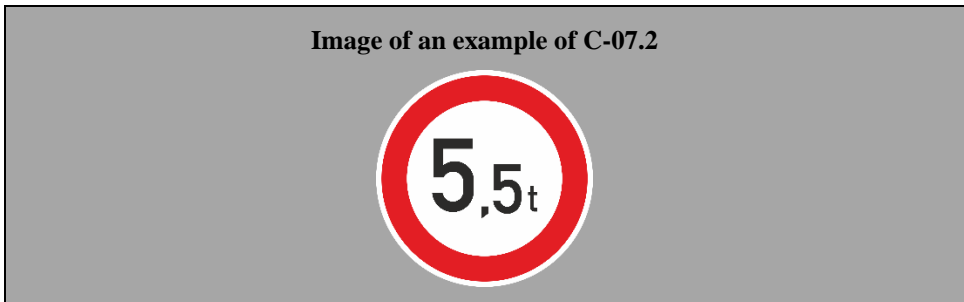

~~C,8 "NO ENTRY FOR VEHICLES HAVING A MASS EXCEEDING ...TONNES ON ONE AXLE"~~

C-08.1 notifies that entry is prohibited for vehicles having a mass (in tonnes) on one axle exceeding the indicated figure on the sign.

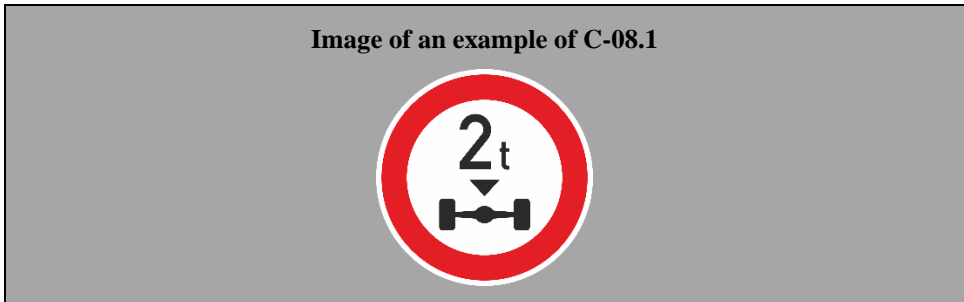

C-08.2 notifies that entry is prohibited for vehicles having a mass (in tonnes), with a decimal fraction, on one axle exceeding the indicated figure

on the sign. The decimal fraction shall be depicted with a “comma” or a “dot” depending on the indication of decimal fractions in the State concerned.

Image of an example of C-08.2



~~C, 9 "NO ENTRY FOR VEHICLES OR COMBINATIONS OF VEHICLES EXCEEDING ... METRES IN LENGTH". NO ENTRY FOR TOO LONG VEHICLES~~

C-09.0 notifies that entry is prohibited for vehicles or combinations of vehicles having a length exceeding the indicated figure (in metres) on the sign.

Image of an example of C-09.0



2. Prohibition of driving too close

PROHIBITION OF DRIVING TOO CLOSE

~~(f) Notification that vehicles shall not be driven closer together than the distance indicated on the sign shall be given by sign C,10, "DRIVING OF VEHICLES LESS THAN ... METRES APART PROHIBITED".~~ **C-10.0** notifies that vehicles shall not be driven closer together than the figure indicating the distance in metres on the sign.

Image of an example of C-10.0



23. Prohibition of turning

~~Notification that turning is prohibited (to the right or to the left according to the direction of the arrow) shall be given by sign C, 11a "NO LEFT TURN" or sign C, 11b "NO RIGHT TURN".~~

NO LEFT TURN

C-11.1 notifies that turning to the left is prohibited.



NO RIGHT TURN

C-11.2 notifies that turning to the right is prohibited.



34. Prohibition of U-turns

~~(a) Notification that U-turns are prohibited shall be given by sign C-12 "NO U-TURNS".~~

~~(b) The symbol may be reversed, if appropriate.~~

NO U-TURN

C-12.0 notifies that a U-turn is prohibited. The symbol on this sign shall be reversed for traffic keeping to the left.

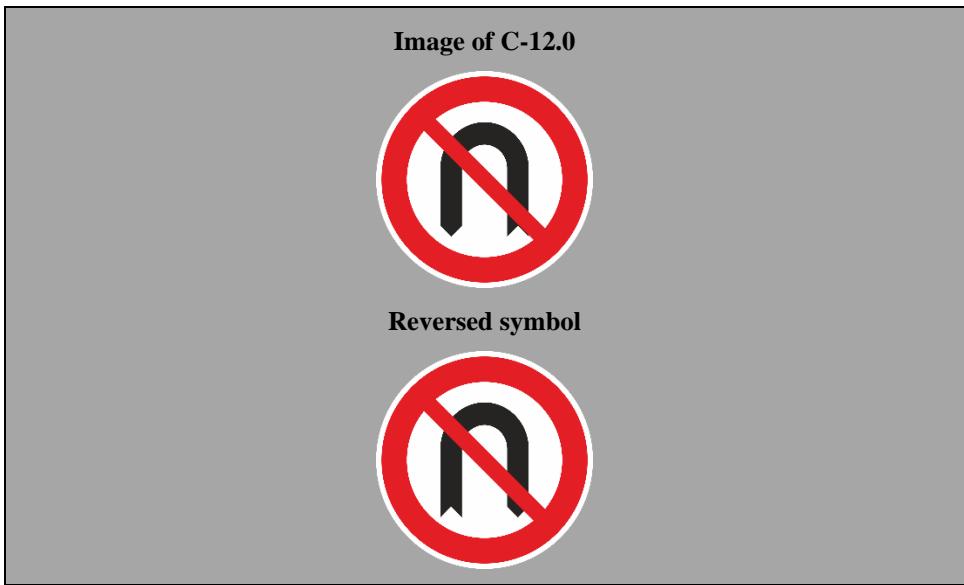

45. Prohibition of overtaking

PROHIBITION OF OVERTAKING

C-13.1 notifies ~~(a) Notification~~ that, in addition to the general rules on overtaking laid down by the regulations in force, the overtaking of power-

driven vehicles other than two-wheeled mopeds and two-wheeled motor cycles without side-car travelling on a road is prohibited., shall be given by sign C, 13a "OVERTAKING PROHIBITED". The symbol on this sign shall be reversed, if necessary, for traffic keeping to the left. Contracting Parties shall select a variant of this sign with or without the red oblique bar.

There are two models of this sign: C, 13aa and C, 13ab.

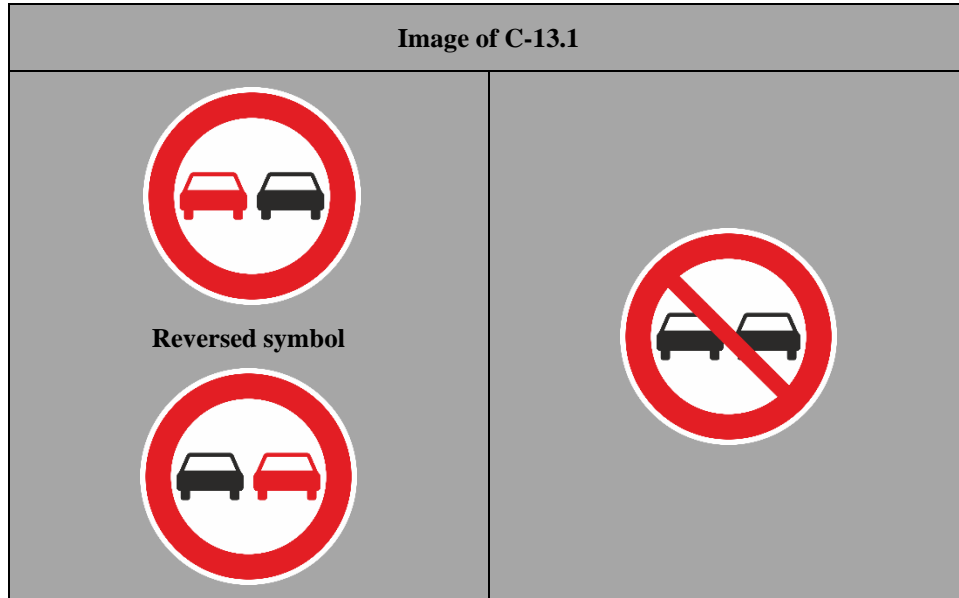

END OF PROHIBITION OF OVERTAKING

C-13.2 notifies that the prohibition of overtaking indicated by sign C-13.1 ceases to apply.

This sign shall be circular and have a white or yellow ground; it shall have no border or only have preferably a black rim, it shall show in light grey the symbol of the prohibition of overtaking which has ceased; and shall bear an oblique black band or preferably, black parallel lines forming such a band, sloping downward from right to left. The oblique band may be interrupted when crossing the grey symbol. If not interrupted, the band shall be placed over the grey symbol.

Notwithstanding the provisions of Article 6, paragraph 1 of this Convention, this sign may be placed on the reverse side of the prohibition of overtaking sign for traffic coming in the opposite direction.

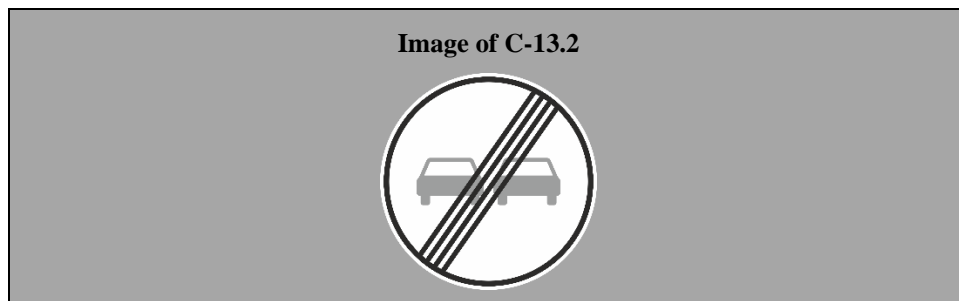

PROHIBITION OF OVERTAKING BY GOODS VEHICLES

C-13.3 notifies (b) Notification that overtaking is prohibited only for goods vehicles having a permissible maximum mass exceeding 3.5 tonnes shall be given by sign C, 13b "OVERTAKING BY GOODS VEHICLES PROHIBITED". The symbol on this sign shall be reversed for traffic

keeping to the left. Contracting Parties shall select a variant of this sign with or without the red oblique bar.

~~There are two models of this sign: C, 13ba and C, 13bb.~~

An inscription on an additional panel placed below the sign in accordance with Article 8, paragraph 4 of this Convention may change the permissible maximum mass above which the prohibitions applyies.

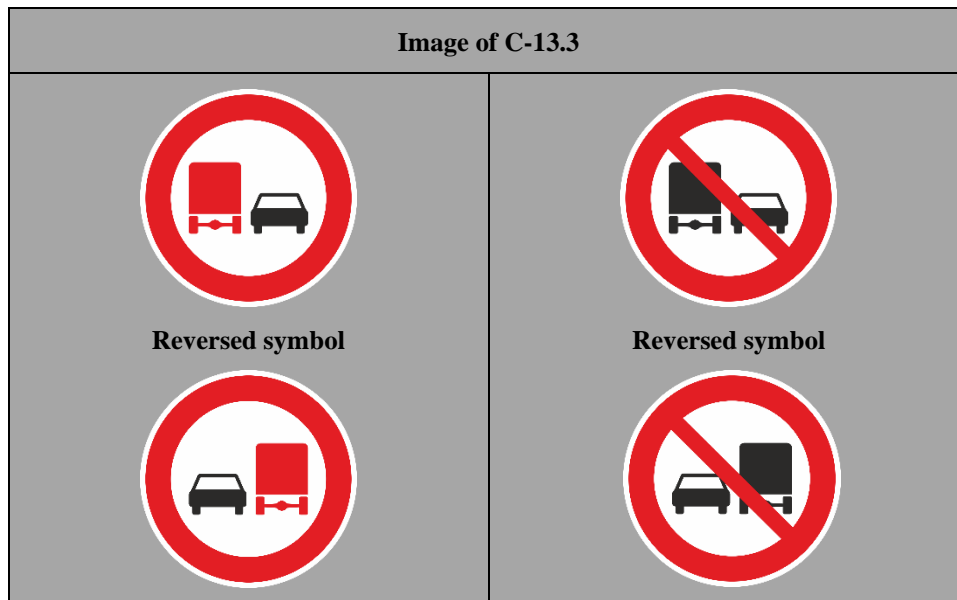

END OF PROHIBITION OF OVERTAKING FOR GOODS VEHICLES

C-13.4 notifies that the prohibition of overtaking for goods vehicles indicated by sign C-13.3 ceases to apply. The symbol on this sign shall be reversed for traffic keeping to the left.

This sign shall be circular and have a white or yellow ground; it shall have no border or only have preferably a black rim, it shall show in light grey the symbol of the prohibition of overtaking which has ceased; and shall bear an oblique black band or preferably, black parallel lines forming such a band, sloping downward from right to left. The oblique band may be interrupted when crossing the grey symbol. If not interrupted, the band shall be placed over the grey symbol.

Notwithstanding the provisions of Article 6, paragraph 1 of this Convention, this sign may be placed on the reverse side of the prohibition of overtaking for goods vehicles sign for traffic coming in the opposite direction.

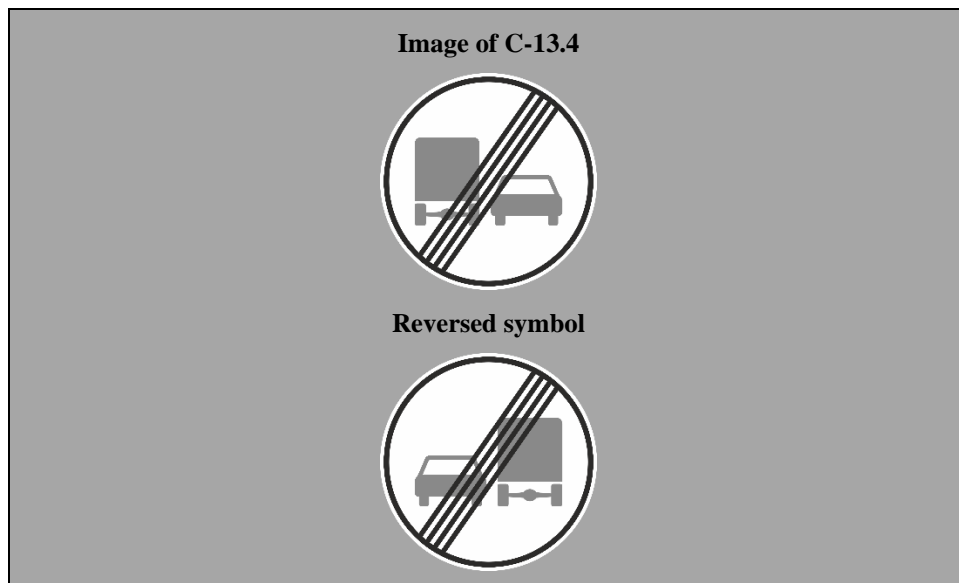

56. Speed limit

MAXIMUM SPEED LIMIT

C-14.1 notifies that the figure indicated on the sign is the permitted maximum speed. ~~(a) Notification of a speed limit shall be given by sign C, 14, "MAXIMUM SPEED LIMITED TO THE FIGURE INDICATED". The figure appearing on the sign shall indicate the maximum speed. The figure shall be provided in the unit of measurement most commonly used to express the speed of vehicles in the country concerned. That unit of measurement may be shown on the sign after or below the figure. If shown, "km" (for Kilometres) or "m" (for Miles) shall be used as appropriate. After or below the figure expressing the speed may be added, for instance, "Km" (Kilometres) or "m" (Miles).~~

~~(b)~~ To indicate a speed limit applicable only to vehicles of a permissible maximum mass exceeding a given figure, an inscription comprising that figure shall be placed on an additional panel below the sign in accordance with Article 8, paragraph 4 of this Convention.

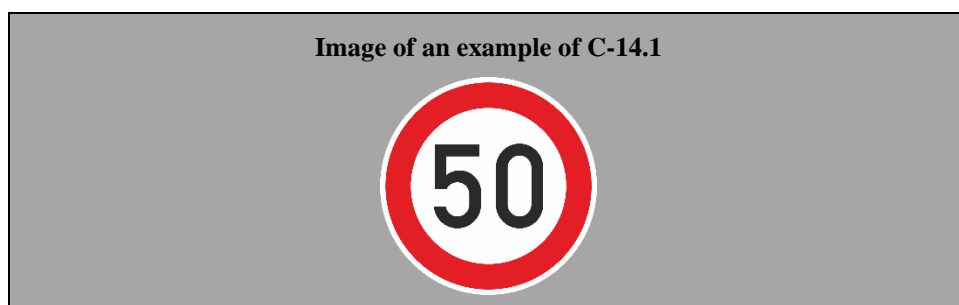

END OF MAXIMUM SPEED LIMIT

C-14.2 notifies that the maximum speed limit indicated by sign C-14.1 ceases to apply.

This sign shall be circular and have a white or yellow ground; it shall have no border or only have preferably a black rim, it shall show in light grey the speed limit inscription which has ceased; and shall bear an oblique black band or preferably, black parallel lines forming such a band, sloping downward from right to left. The oblique band may be interrupted when crossing the grey inscription. If not interrupted, the band shall be placed over the grey symbol.

Notwithstanding the provisions of Article 6, paragraph 1 of this Convention, this sign may be placed on the reverse side of the maximum speed sign for traffic coming in the opposite direction.

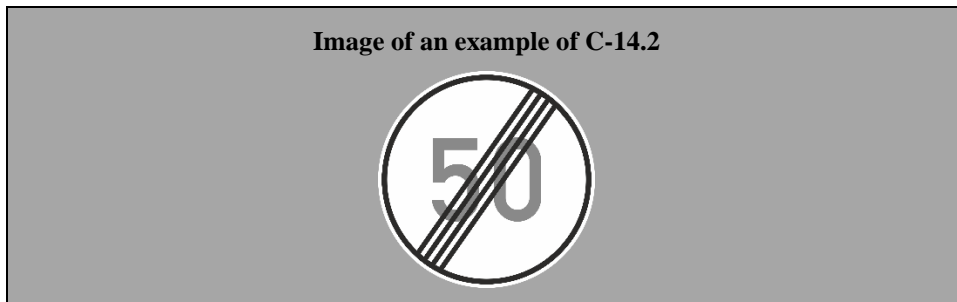

67. Prohibition of the use of audible warning devices

PROHIBITION OF THE USE OF AUDIBLE WARNING DEVICES

C-15.0 notifies ~~Notification~~ that the use of audible warning devices is prohibited, except to avoid an accident, ~~shall be given by sign C, 15 "USE OF AUDIBLE WARNING DEVICES PROHIBITED"~~.

This sign, if not placed at the beginning of a built-up area beside or shortly after the sign identifying the built-up area, shall be accompanied by an additional panel ~~H, 2~~ **H-02.0** described in section H, **subsection II, paragraph 1** of this ~~a~~ Annex, showing the distance over which the prohibition applies. It is recommended that this sign should not be placed at the beginning of built-up areas when the prohibition applies in all built-up areas and that it be provided that the sign identifying a built-up area placed at the beginning of that area shall notify road users that the traffic regulations applicable to built-up areas in that country apply from that point onwards.



78. Prohibition of passing without stopping

PROHIBITION OF PASSING WITHOUT STOPPING

C-16.0 notifies that passing without stopping is prohibited. When used in (a) ~~Notification of~~ the proximity of a Customs-house at which a stop is compulsory ~~shall be given by sign C, 16, "PASSING WITHOUT STOPPING PROHIBITED"~~, ~~Notwithstanding Article 8 of this Convention, the symbol of this sign shall include the word inscription "Customs", preferably in two languages.~~ Contracting Parties using ~~C, 16~~ **this** signs shall endeavour to reach a regional agreement to the effect that this ~~word inscription~~ shall appear in the same language(s) on all the signs they set up.

(b) ~~This sign may also be used to notify drivers that passing without stopping is prohibited for~~ **When used for other reasons;** ~~in this case the inscription word "Customs" shall be replaced by another very brief inscription indicating the reason for the stop.~~

Image of an example of C-16.0



89. End of prohibition or restriction

(a) The point at which all prohibitions notified by prohibitory signs for moving vehicles cease to apply shall be indicated by sign C, 17a "END OF ALL LOCAL PROHIBITIONS IMPOSED ON MOVING VEHICLES". This sign shall be circular and have a white or yellow ground; it shall have no border or only a black rim, and shall bear a diagonal band, sloping downward from right to left, which may be black or dark grey or consist of black or grey parallel lines.

(b) The point at which a particular prohibition or restriction notified to moving vehicles by a prohibitory or restrictive sign ceases to apply shall be indicated by sign C, 17b "END OF SPEED LIMIT" or sign C, 17c "END OF PROHIBITION OF OVERTAKING", OR SIGN C, 17d "END OF PROHIBITION OF OVERTAKING FOR GOODS VEHICLES". These signs shall be similar to sign C, 17a, but shall show, in addition, in light grey the symbol of the prohibition or restriction which has ceased.

(c) Notwithstanding the provisions of Article 6, paragraph 1 of this Convention, the signs referred to in this paragraph 8 may be placed on the reverse side of the prohibitory or restrictive sign intended for traffic coming in the opposite direction.

END OF PROHIBITION OR RESTRICTION

C-17.0 notifies that all prohibitions or restrictions notified indicated by prohibitory or restrictive signs for moving vehicles cease to apply. This sign shall be circular and have a white or yellow ground; it shall have no border or only have preferably a black rim, and shall bear an oblique black band, or preferably, black parallel lines forming such a band, sloping downward from right to left.

Notwithstanding the provisions of Article 6, paragraph 1 of this Convention, this sign may be placed on the reverse side of the prohibitory or restrictive sign intended for traffic coming in the opposite direction.

Image of C-17.0

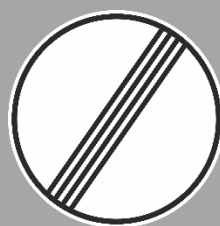

910. Prohibition or restriction of standing and parking

(a) (i) Places where parking is prohibited shall be indicated by sign C, 18, "PARKING PROHIBITED"; places where standing and parking are prohibited

shall be indicated by sign C, 19, "STANDING AND PARKING PROHIBITED".

(ii) Sign C, 18 may be replaced by a circular sign with a red border and a red transverse bar, bearing the letter or ideogram used in the State concerned to denote "Parking", in black on a white or yellow ground.

PROHIBITION OF PARKING

C-18.0 notifies of places where parking is prohibited. Parking may also be prohibited by a circular sign with a red border and a red oblique bar sloping downwards from left to right, bearing the letter used in the State concerned to denote "Parking", in black or dark blue on a white or yellow ground.



PROHIBITION OF STANDING AND PARKING

C-19.0 notifies of places where standing and parking are prohibited



(iii) The scope of the prohibition notified by signs C-18.0 and C-19.0 may be restricted by inscriptions on an additional plate-panel below the sign specifying, as the case may be:

- (a) The days of the week or month or the times of day during which the prohibition applies;
- (b) The time in excess of which parking is prohibited by sign C, 18 or standing and parking is prohibited by sign C, 19;
- (c) The exceptions granted for certain classes of road user.

(iv) The time in excess of which parking or standing is prohibited may also be inscribed on the lower part of the red circle of the sign instead of appearing on an additional plate panel.

ALTERNATE PARKING

(b) (i) Where parking is authorized on opposite sides of the road alternately, signs C, 20a and C, 20b, "ALTERNATE PARKING", shall be used instead of sign C, 18;

C-20.1 notifies of places where parking is authorized on one side and prohibited on the opposite side of the road on days of the month that are an odd number. The time at which the side changes shall be prescribed by

domestic legislation and need not necessarily be from midnight. The bar on the sign shall be white.



C-20.2 notifies of places where parking is authorized on one side and prohibited on the opposite side of the road on days of the month that are an even number. The time at which the side changes shall be prescribed by domestic legislation and need not necessarily be from midnight. The two bars on the sign shall be white.

(ii) ~~The prohibition of parking shall apply to the sign C, 20a side on odd number dates and to the sign C, 20b side on even number dates; the time at which the side changes shall be prescribed by domestic legislation and need not necessarily be midnight.~~



C-20.3 notifies of places where parking is authorized on opposite sides of the road which alternates when the ~~Domestic legislation may also~~ prescribes an alternation other than a daily alternation for parking; ~~the numerals I and II shall in that case be replaced on the signs by~~ **this sign may contain** the period of alternation, e.g., 1-15 and 16-31 for an alternation on the first and sixteenth day of each month.

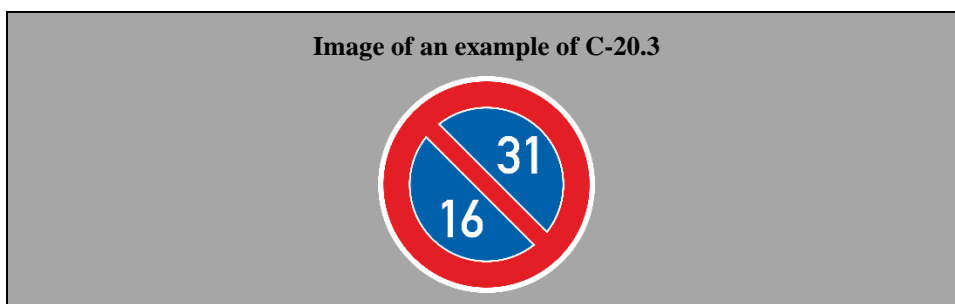

Additional provisions applying to the prohibition or restriction of standing and parking

(iii) ~~Sign C, 18 may be used by States which do not adopt sign C, 19; C, 20 a and C, 20b , supplemented by additional inscriptions, as provided in Article 8, paragraph 4 of this Convention~~

Contracting Parties which do not adopt signs C-19.0, C-20.1, C-20.2, C-20.3, may use instead the sign C-18.0 supplemented by additional inscriptions, as provided in Article 8, paragraph 4 of this Convention.

~~(c) — (i) — Except in special cases, the signs shall be so placed that their disc is perpendicular to the axis of the road, or at a slight angle to the plane perpendicular to that axis.~~

The signs that notify parking prohibitions and restrictions, except in special cases, shall be placed is perpendicular to the axis of the road, or at a slight angle to the plane perpendicular to that axis. In special cases, the signs may be placed parallel to the axis of the road. When additional panels are used in those cases, they shall be of models H-03.1, H-03.2 and H-03.3 described in section H.

~~(ii) — All the prohibitions and restrictions of parking shall apply only on the side of the carriageway on which the signs are placed.~~

~~(iii) — Except as may be otherwise indicated:~~

~~On an additional panel H, 2 of section H of this annex and showing the distance over which the prohibition applies; or~~

~~In conformity with subparagraph (c) (v) of this paragraph, †~~**The prohibitions and restrictions of parking shall apply from a point level with the sign to the next point of entry of a road unless indicated otherwise.**

~~(iv) — An additional panel H, 3a or H, 4a depicted in section H of this annex may be placed below the sign at the point where the prohibition begins. An additional panel H, 3b or H, 4b depicted in section H of this annex may be placed below signs repeating the prohibition. A further prohibition sign supplemented by an additional panel H, 3c or H, 4c depicted in section H of this annex may be placed at the point where the prohibition ceases to apply. Panels H, 3 shall be placed parallel to the axis of the road, and panels H, 4 perpendicular to that axis. The distances, if any, shown by panels H, 3 shall be those over which the prohibition applies in the direction of the arrow.~~

If the prohibition and restrictions of parking cease to apply before the next point of entry of a road, the sign supplemented by an additional panel H-03.1 or H-04.1 described in section H used at the point where the parking prohibition begins. An additional panel H-03.2 or H-04.2 described in section H, subsection II, paragraph 2 may be used to repeat the prohibition provided that respectively additional panels H-03.1 or H-04.1 are used to indicate the beginning of the prohibition. An additional panel H-03.3 or H-04.3 described in section H shall be used where the prohibition ceases to apply provided that respectively additional panels H-03.1 or H-04.1 are used to indicate the beginning of the prohibition, except when another parking regulation applies. Panels H-03.1, H-03.2 and H-03.3 shall be placed parallel to the axis of the road, and panels H-04.1, H-04.2 and H-04.3 perpendicular to that axis. The distances, if any, shown by these panels shall be those over which the prohibition applies in the direction of the arrow.

~~(v) — If the prohibition ceases to apply before the next point of entry of a road, the sign bearing the additional end of prohibition panel described in subparagraph (c) (iv) above shall be set up. However, where~~**If the prohibition applies only over a short distance, it shall be permissible to set up only one sign:**

- ~~Showing in the red circle-border the distance on which it applies, or~~
- ~~Bearing an additional panel H, 3~~**H-02.0, H-03.1 or H-04.1, described in section H, showing the short distance.**

~~(vi) — Where parking-metres are installed, their presence shall signify that parking is subject to payment and is limited to the period for which the meter operates.~~

Section D

MANDATORY SIGNS

I. General characteristics and symbols

1. Mandatory signs shall be circular, except signs ~~D, 10D-08.0~~ **D-08.0** described in subsection II, paragraph 10 of this section which shall be rectangular; their diameter shall be not less than 0.60 m outside built-up areas and not less than 0.40 m in built-up areas. However, signs having a diameter of not less than 0.30 m may be used in conjunction with traffic light signals or on bollards on traffic islands.

2. Unless provided otherwise, the signs shall be blue and the symbols shall be white. ~~or of a light colour, or, alternatively, the signs shall be white with a red rim and the symbols shall be black.~~

II. ~~Descriptions~~ Definitions and images

1. Direction to be followed

DIRECTION LEFT TO BE FOLLOWED

D-01.1 notifies that the only direction in which vehicles are obliged to proceed is to the left.

~~The direction in which vehicles are obliged to proceed, or the only directions in which they are permitted to proceed, shall be indicated by model D, 1a of sign D, 1, "DIRECTION TO BE FOLLOWED" on which the arrow or arrows shall point in the appropriate direction or directions. However, instead of using sign D, 1a, sign D, 1b may to be used notwithstanding the provisions of subsection I of this section. Sign D, 1b shall to be black with a white rim and a white symbol.~~

Image of D-01.1



D-01.2 notifies that the only direction in which vehicles are obliged to proceed is to the left

Image of D-01.2



DIRECTION LEFT OR STRAIGHT TO BE FOLLOWED

D-01.3 notifies that the only directions in which vehicles are obliged to proceed are to the left or straight.

Image of D-01.3



DIRECTION STRAIGHT TO BE FOLLOWED

D-01.4 notifies that the only direction in which vehicles are obliged to proceed is straight.

Image of D-01.4



DIRECTION RIGHT TO BE FOLLOWED

D-01.5 notifies that the only direction in which vehicles are obliged to proceed is to the right.

Image of D-01.5



D-01.6 notifies that the only direction in which vehicles are obliged to proceed is to the right.

Image of D-01.6



DIRECTION RIGHT OR STRAIGHT TO BE FOLLOWED

D-01.7 notifies that the only directions in which vehicles are obliged to proceed are to the right or straight.

Image of D-01.7

**DIRECTION LEFT OR RIGHT TO BE FOLLOWED**

D-01.8 notifies that the only directions in which vehicles are obliged to proceed are to the left or to the right.

Image of D-01.8

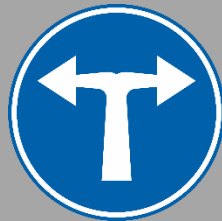
**2. Pass this side****PASS ON THE LEFT SIDE**

~~Sign D, 2 "PASS THIS SIDE", placed, notwithstanding the provisions of Article 6, paragraph 1 of this Convention, on an island or before an obstacle on the carriageway, shall mean that vehicles must pass on the side of the island or obstacle indicated by the arrow.~~

D-02.1 notifies that vehicles must pass the island or obstacle on the left side. Notwithstanding the provisions of Article 6, paragraph 1 of this Convention, this sign is placed on the island or before the obstacle on the carriageway.

Image of D-02.1

**PASS ON THE RIGHT SIDE**

D-02.2 notifies that vehicles must pass the island or obstacle on the right side. Notwithstanding the provisions of Article 6, paragraph 1 of this

Convention, this sign is placed on the island or before the obstacle on the carriageway.

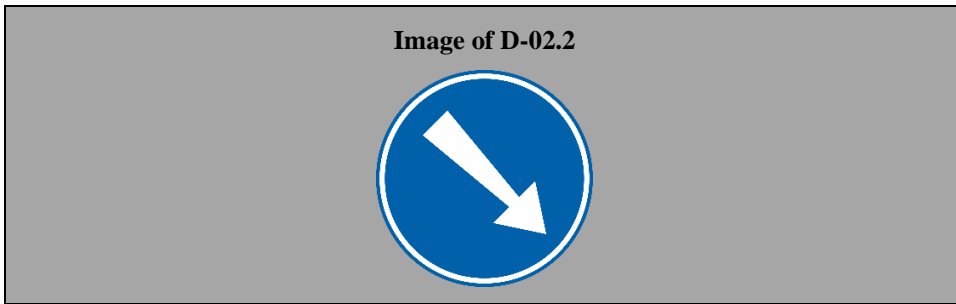

PASS ON THE LEFT OR ON THE RIGHT SIDE

D-02.3 notifies that vehicles must pass the island or obstacle on the left or on the right side. Notwithstanding the provisions of Article 6, paragraph 1 of this Convention, this sign is placed on the island or before the obstacle on the carriageway.



3. Compulsory roundabout

COMPULSORY ROUNDABOUT

~~3. Sign D-3 D-03.0 'COMPULSORY ROUNDABOUT', shall notify that~~ **vehicles must follow** the direction at the roundabout indicated by the arrows. If the **compulsory** roundabout is indicated by the sign ~~D-3 D-03.0~~ together with the sign ~~B-1 B-01.0~~ or ~~B-2 B-02.0~~, the ~~driver vehicle~~ **driver vehicle** in the roundabout has priority. **The symbol on this sign shall be reversed for traffic keeping to the left.**

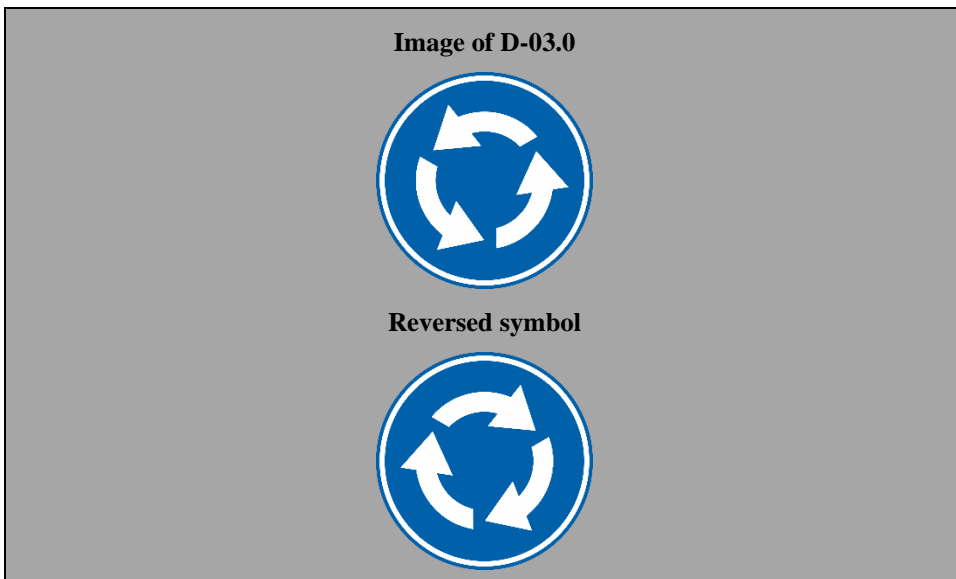

4. Compulsory cycle track

COMPULSORY CYCLE TRACK

~~Sign D, 4 a "COMPULSORY CYCLE TRACK" shall~~ **D-04.1** notifies cyclists that the track at the entrance to which it is placed is reserved for them, and ~~shall notify~~ the drivers of other vehicles that they are not entitled to use that track. Cyclists shall be required to use the track if the track is running along a carriageway, footpath or track for riders on horseback and leading into the same direction. However, drivers of mopeds shall also be required, in the same conditions, to use the cycle track if domestic legislation so provides or if notification of this requirement is given by an additional panel bearing an inscription or the symbol of sign ~~C, 3 d~~ **C-03.4**.

Image of D-04.1



END OF COMPULSORY CYCLE TRACK

D-04.2 notifies cyclists of the end of the compulsory cycle track. This sign shall be identical to the sign D-04.1, except that it shall be crossed by an oblique red band or, preferably, red parallel lines forming such a band, sloping down from right to left. The band can be interrupted when crossing the symbol. If not interrupted, the red band shall be placed over the symbol.

Notwithstanding the provisions of Article 6, paragraph 1 of this Convention, this sign may be placed on the reverse side of the sign D-04.1 for cyclists coming in the opposite direction.

Image of D-04.2



5. Compulsory footpath

COMPULSORY FOOTPATH

~~Sign D, 5 a "COMPULSORY FOOTPATH" shall~~ **D-04.3** notifies pedestrians that the path at the entrance to which it is placed is reserved for them, and ~~shall notify~~ other road users that they are not entitled to use that path. Pedestrians shall be required to use the path if the path is running along a carriageway, cycle track or track for riders on horseback and leading into the same direction.

Image of D-04.3

**END OF COMPULSORY FOOTPATH**

D-04.4 notifies pedestrians of the end of the compulsory footpath. This sign shall be identical to the sign D-04.3, except that it shall be crossed by an oblique red band or, preferably, red parallel lines forming such a band sloping down from right to left. The band can be interrupted when crossing the symbol. If not interrupted, the red band shall be placed over the symbol.

Notwithstanding the provisions of Article 6, paragraph 1 of this Convention, this sign may be placed on the reverse side of the sign D-04.3 for pedestrians coming in the opposite direction.

Image of D-04.4

**6. Compulsory track for riders on horseback****COMPULSORY TRACK FOR RIDERS ON HORSEBACK**

~~Sign D, 6 a "COMPULSORY TRACK FOR RIDERS ON HORSEBACK"~~
~~shall D-04.5 notifies~~ riders on horseback that the track at the entrance of which it is placed is reserved for them and ~~shall notify~~ notifies other road users that they are not entitled to use that track. Riders on horseback shall be required to use the track if the track is running along a carriageway, cycle track or footpath and leading into the same direction.

Image of D-04.5

**END OF COMPULSORY TRACK FOR RIDERS ON HORSEBACK**

D-04.6 notifies riders on horseback of the end of the compulsory track for them. This sign shall be identical to the sign D-04.5, except that it shall be crossed by an oblique red band or, preferably, red parallel lines forming such a band sloping down from right to left. The band can be interrupted

when crossing the symbol. If not interrupted, the red band shall be placed over the symbol.

Notwithstanding the provisions of Article 6, paragraph 1 of this Convention, this sign may be placed on the reverse side of the sign D-04.5 for riders on horseback coming in the opposite direction.



7. Compulsory path or track for two categories of road users

COMPULSORY PATH OR TRACK FOR TWO CATEGORIES OF ROAD USERS

D-05.1 notifies the two categories of road users depicted by symbols on this sign that the path or track, at the entrance of which the sign is placed, is reserved for them; and notifies other road users that they are not entitled to use that path or track. The road users depicted by symbols on this sign shall be required to use that path or track.

The symbols of the road users shall be placed side by side on this sign and separated by a vertical line through its centre. Each symbol shall be understood to mean that the relevant category must use the side of the path or track reserved for that category and shall notify other road users that they are not entitled to use that side. The two sides of the path or track shall be clearly separated, by physical means or road markings.

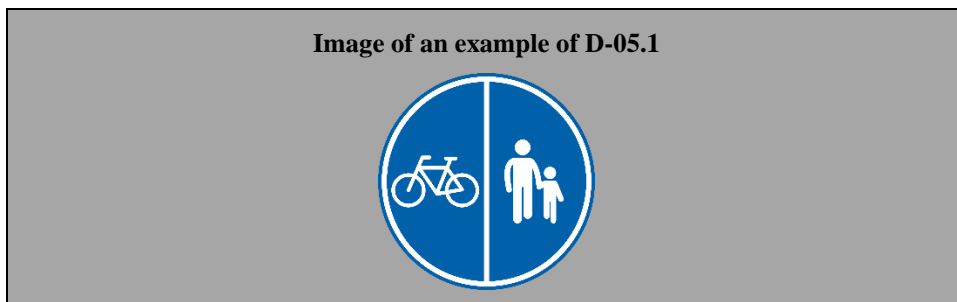

END OF COMPULSORY PATH OR TRACK FOR TWO CATEGORIES OF ROAD USERS

D-05.2 notifies the two categories of road users depicted by symbols on this sign of the end of the compulsory path or track for them. This sign shall be identical to the sign D-05.1, except that it shall be crossed by an oblique red band or, preferably, red parallel lines forming such a band sloping down from right to left. The band can be interrupted when crossing the symbols. If not interrupted, the red band shall be placed over the symbols.

Notwithstanding the provisions of Article 6, paragraph 1 of this Convention, this sign may be placed on the reverse side of the sign D-05.1 for the same road users coming in the opposite direction.

Image of an example of D-05.2



COMPULSORY SHARED PATH OR TRACK FOR TWO CATEGORIES OF ROAD USERS

D-05.2 notifies the two categories of road users depicted by symbols on this sign that the path or track, at the entrance of which it is placed, is reserved for their shared use; and notifies other road users that they are not entitled to use that path or track. The road users depicted by symbols on this sign shall be required to use that path or track.

The symbols of the road users shall be placed one above the other on this sign. The order in which the symbols are placed shall be optional. Where necessary the precautions to be taken by both categories of users shall be laid down in domestic legislation.

Image of an example of D-05.3



END OF COMPULSORY SHARED PATH OR TRACK FOR TWO CATEGORIES OF ROAD USERS

D-05.3 notifies the two categories of road users depicted by symbols on this sign of the end of the compulsory shared path or track for them. This sign shall be identical to the sign D-05.3, except that it shall be crossed by an oblique red band or, preferably, red parallel lines forming such a band sloping down from right to left. The band can be interrupted when crossing the symbols. If not interrupted, the red band shall be placed over the symbols.

Notwithstanding the provisions of Article 6, paragraph 1 of this Convention, this sign may be placed on the reverse side of the sign D-05.3 for the same road users coming in the opposite direction.

Image of an example of D-05.4



78. Compulsory minimum speed

COMPULSORY MINIMUM SPEED

~~Sign D, 7 "COMPULSORY MINIMUM SPEED", shall mean D-06.1 notifies drivers that vehicles using the road at the entrance to which it is placed they shall travel at not less than the speed specified. †The figure shown on the sign shall express this speed in the unit of measurement most commonly used to express the speed of vehicles in the country concerned. After the figure specifying the speed, for instance, "Km" (Kilometres) or "m" (Miles) may be added. That unit of measurement may be shown on the sign after or below the digit.~~

Image of an example of D-06.1



8. End of compulsory minimum speed

END OF COMPULSORY MINIMUM SPEED

~~Sign D, 8 "END OF COMPULSORY MINIMUM SPEED", shall mean D-06.2 notifies drivers that the compulsory minimum speed imposed by sign D, 7D-06.1 is no longer in effect. Sign D, 8 This sign shall to be identical to sign D, 7D-06.1, except that it shall be crossed by an oblique red bar-band or, preferably, red parallel lines forming such a band running from the upper right edge to the lower left edge sloping down from right to left. The band can be interrupted when crossing the figure shown on the sign. If not interrupted, the red band shall be placed over the figure.~~

Notwithstanding the provisions of Article 6, paragraph 1 of this Convention, this sign may be placed on the reverse side of the sign D-06.1 for drivers coming in the opposite direction.

Image of an example of D-06.2



9. Snow chains compulsory

COMPULSORY SNOW CHAINS

~~Sign D, 9 a, "SNOW CHAINS COMPULSORY" shall mean D-07.1 notifies drivers that their vehicles travelling on the road at the entrance to which it is placed shall have snow chains fitted to not less than two of their driving wheels in situations when the carriageway is covered by snow and/or ice.~~

Image of D-07.1

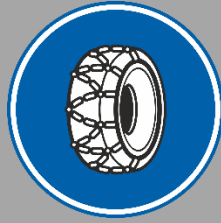

END OF COMPULSORY SNOW CHAINS

D-07.2, notifies drivers that the compulsory use of snow chains imposed by the sign D-07.1 is no longer in effect. This sign shall be identical to the sign D-07.1, except that it shall be crossed by an oblique red band or, preferably, red parallel lines forming such a band sloping down from right to left. The band can be interrupted when crossing the symbol. If not interrupted, the red band shall be placed over the symbol.

Notwithstanding the provisions of Article 6, paragraph 1 of this Convention, this sign may be placed on the reverse side of the sign D-07.1 for drivers coming in the opposite direction.

Image of D-07.2

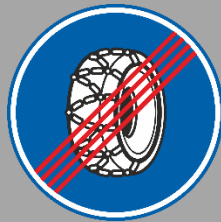

10. Compulsory direction for vehicles carrying dangerous goods

~~Sign D, 10a; D, 10b and D, 10c shall indicate the direction in which vehicles carrying dangerous goods shall proceed.~~

COMPULSORY DIRECTION FOR VEHICLES CARRYING DANGEROUS GOODS

D-08.0 notifies drivers of vehicles carrying dangerous goods of the direction in which they shall proceed. This sign shall depict one of the symbols used on signs C-03.8, C-03.13 or C-03.14 to specify the type of dangerous goods carried and one of the signs D-01.1, D-01.2, D-01.4, D-01.5, D-01.6 to specify the direction to follow.

The ground of this sign shall be white.

Image of an example of D-08.0

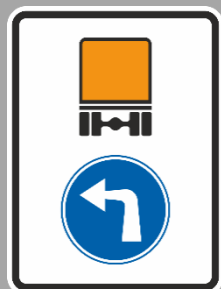

11. Remarks concerning the combination of signs D, 4; D, 5 and D, 6

~~(a) Notification that a path or track is reserved to two categories of road users and prohibited to other users shall be indicated by a mandatory sign bearing the two symbols for the categories of users entitled to use the path or track at the entrance to which it is placed.~~

~~(b) When the symbols are placed side by side on the sign and separated by a vertical line through the centre of the sign, each symbol shall be understood to mean that the relevant category must use the side of the path or track reserved for that category and shall notify other road users that they are not entitled to use that side. The two sides of the path or track shall be clearly separated, by physical means or road markings.~~

~~(c) When the symbols are placed one above the other, the sign shall notify the relevant categories of users that they may jointly use the path or track. The order in which the symbols are placed shall be optional. Where necessary the precautions to be taken by both categories of users shall be laid down in domestic legislation.~~

~~Sign D, 11a and D, 11b are examples of the combination of signs D, 4 and D, 5.~~

Section E

SPECIAL REGULATION SIGNS

I. General characteristics and symbols

Special regulation signs are square or rectangular, usually with a blue ground and a light-coloured symbol or inscription, or with a light coloured ground and a dark coloured symbol or inscription.

II. ~~Descriptions~~ Definitions and images

1. Signs indicating a regulation or danger warning applying to one or more traffic lanes

Signs such as those given below shall mean that a regulation or danger warning applies only to one or more lanes, defined by longitudinal lane markings, on a multi-lane carriageway for traffic moving in the same direction. They may also indicate lanes allocated to oncoming traffic. The sign relating to the regulation or danger warning shall be shown on each of the arrows concerned:

~~(i) E, 1a "COMPULSORY MINIMUM SPEED APPLYING TO DIFFERENT LANES".~~

~~(ii) E, 1b "COMPULSORY MINIMUM SPEED APPLYING TO ONE LANE". This sign may be used as way of creating a "slow lane".~~

~~(iii) E, 1c "SPEED LIMITS APPLYING TO DIFFERENT LANES". Borders of the circles shall be red and letters black.~~

REGULATION OR DANGER WARNING APPLYING TO A LANE

E-01.0 notifies that a regulation or danger warning applies to a lane, defined by longitudinal lane markings, on a multi-lanes carriage way for traffic moving in the same direction. This sign may also indicate a lane allocated to oncoming traffic. The sign relating to the regulation or danger warning shall be shown on each of the arrows concerned.

Image of an example of E-01.0

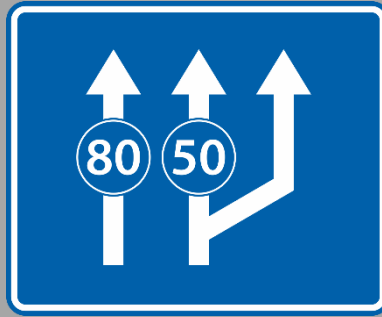

2. Signs indicating lanes reserved for buses or other categories of vehicles

LANE RESERVED FOR BUSES

Signs such as E, 2a and E, 2b are examples of signs showing the position of the lane. E-02.1 notifies road users about the position of the lane, on a multi-lane carriageway, reserved for buses in accordance with Article 26 bisbis, paragraph 2. This sign may also indicate a lane allocated to oncoming traffic. Additional panel H-05.0 with a bus or only the symbol of a bus shall be shown on the arrow concerned.

Image of an example of E-02.1

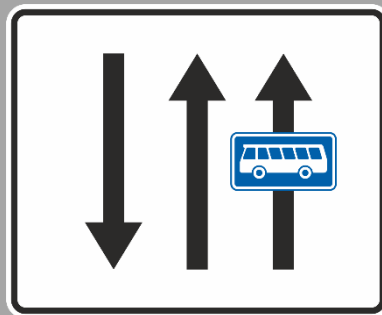

LANE RESERVED FOR OTHER CATEGORIES OF VEHICLES

E-02.2 notifies road users about the position of the lane, on a multi-lane carriageway, reserved for specific categories of vehicles in accordance with Article 26 bis, paragraph 1. Additional panel H-05.0 depicting the symbol of that type of vehicle category, or only the symbol of that vehicle category, shall be shown on the arrow concerned.

Image of an example of E-02.2

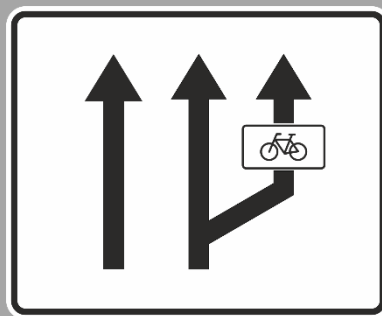

43. Preselection sign

Example of sign for preselection at intersections on roads with several lanes:
E, 4.

PRESELECTION OF LANES

E-03.0 notifies road users about directions to follow for each lane of a multi-lane carriageway at the intersection in order for them to preselect the required lane before the intersection. Lane markings may be included.

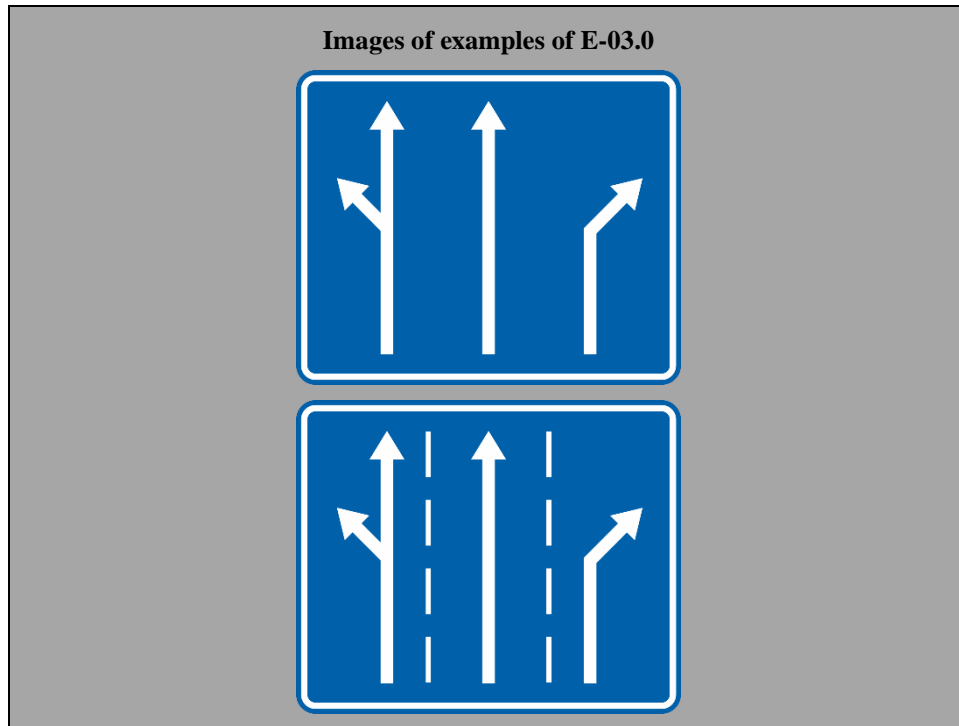

34. "ONE WAY" One-way sign

(a) Two different "ONE WAY" signs may be set up where it is necessary to indicate a road or carriageway which is one way:

(i) Sign E, 3a placed approximately perpendicular to the axis of the carriageway; its panel shall be square.

(ii) Sign E, 3b placed approximately parallel to the axis of the carriageway; its panel shall be an elongated rectangle the long side of which is horizontal. The words "one way" may be inscribed on the arrow of sign E, 3b in the national language or one of the national languages of the country concerned.

ONE-WAY

E-04.1 notifies road users that a carriageway is one way. This sign shall be placed perpendicular to the axis of the carriageway. It shall be square or rectangular, the ground shall be blue and the symbol white.



E-04.2 notifies road users that a carriageway is one way. This sign shall be placed parallel to the axis of the carriageway; it shall be an elongated rectangle with longer horizontal sides, the ground shall be blue and the symbol white. The inscription "One way" may be placed on the arrow of this sign in the national language or one of the national languages of the State concerned. The symbol on this sign may be reversed.

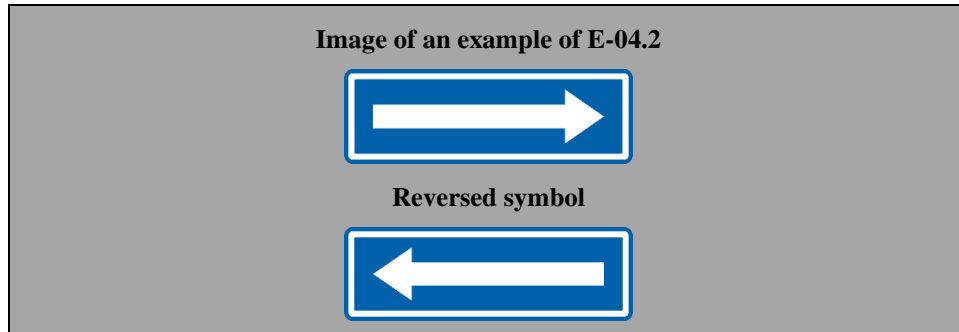

(b) Signs ~~E, 3a~~ **E-04.1** and ~~E, 3b~~ **E-04.2** may be set up irrespective of whether prohibitory or mandatory signs are set up at the entrance to the road in question.

5. Signs notifying an entry to or an exit from a motorway

(a) Sign ~~E, 5a~~, "MOTORWAY", shall be placed at the point where the special rules to be observed on a motorway begin to apply.

MOTORWAY

E-05.1 notifies drivers of vehicles about an entry onto a motorway where the special rules for the motorway begin to apply. The sign shall be placed at the entry to a motorway. It shall have blue or green ground and a white symbol.

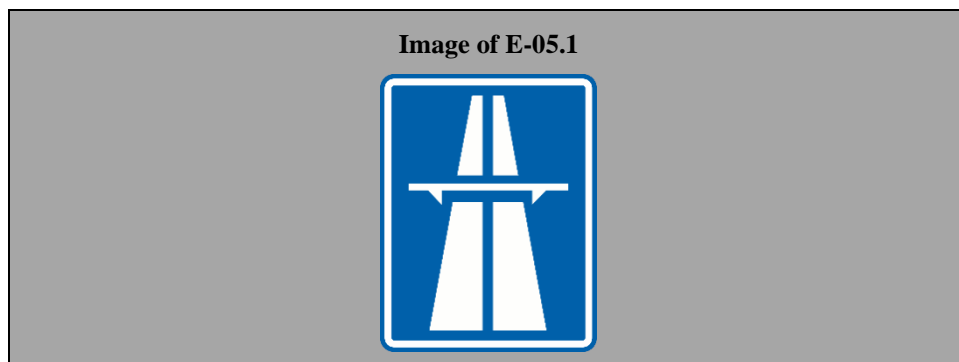

END OF MOTORWAY

(b) Sign ~~E, 5b~~, "END OF MOTORWAY", shall be placed at the point where those rules cease to apply.

E-05.2 notifies drivers of motor vehicles that the special rules imposed by sign **E-05.1** cease to apply from the point of its placement. This sign shall be identical to the sign **E-05.1** except that it shall be crossed by a diagonal red band or, preferably, red parallel lines forming such a band running from the upper right edge to the lower left edge. The diagonal band may be interrupted when crossing the symbol. If not interrupted, the diagonal band shall be placed over the symbol.

(c) Sign ~~E, 5b~~ **This sign** may also be used and repeated to give warning of the ending of a motorway; the distance between each sign set up for this purpose and the end of the motorway shall be inscribed on the lower part of the sign or

on the additional panel H-01.0 described in section H, subsection II, paragraph 1.

~~(d) These signs shall have blue or green ground.~~



6. Signs notifying an entry to or exit from a road on which the traffic rules are the same as on a motorway

ROAD FOR MOTOR VEHICLES

~~(a) Sign E, 6a "ROAD FOR MOTOR VEHICLES", E-06.1~~ **notifies drivers of vehicles about an entry onto a road for motor vehicles shall be placed at the point where special traffic rules, on roads other than motorways, begin to apply on roads other than motorways and which are reserved for motor vehicle traffic and do not serve properties bordering on the road. An additional panel may be placed under this sign E, 6a to show that, by way of exception, the access of motor vehicles to properties bordering on the road is permitted. This sign shall have blue or green ground, and a white symbol.**

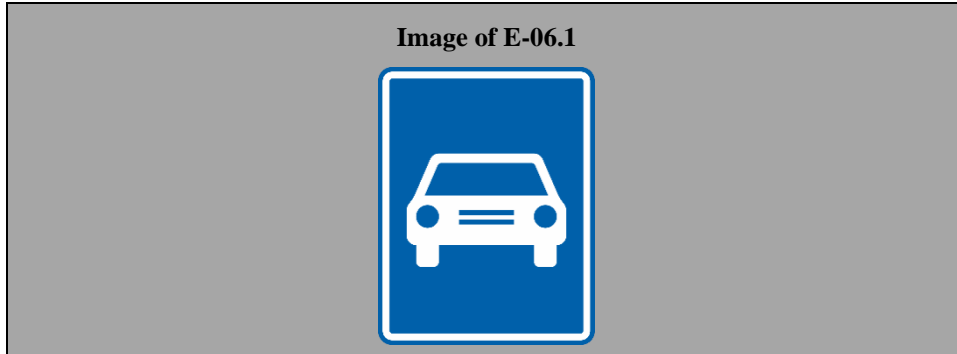

END OF ROAD FOR MOTOR VEHICLES

E-06.2 notifies drivers of motor vehicles that the special rules imposed by sign E-06.1 cease to apply from the point of its placement. This sign shall be identical to the sign E-06.1, except that it shall be crossed by a diagonal red band or, preferably, red parallel lines forming such a band running from the upper right edge to the lower left edge. The diagonal band may be interrupted when crossing the symbol. If not interrupted, the diagonal band shall be placed over the symbol.

~~(b) Sign E, 6b, "END OF ROAD FOR MOTOR VEHICLES",~~ **This sign may also be used and repeated to give warning of the ending of the road; the distance between each sign set up for this purpose and the end of the road shall be inscribed on the lower part of the sign or on the additional panel H-01.0 described in section H, subsection II, paragraph 1.**

~~(c) These signs shall have blue or green ground.~~

Image of E-06.2



7. Signs indicating the beginning and the end of a built-up area

BEGINNING OF A BUILT-UP AREA

(a) The sign to indicate the beginning of a built-up area shall bear the name of the built-up area or the symbol showing the silhouette of a built-up area or the two combined. Signs E, 7 a; E, 7b; E, 7c and E, 7d are examples of signs showing the beginning of a built-up area.

E-07.1 notifies road users about the beginning of a built-up area where special regulations governing traffic in built-up areas in the territory of the State apply. This sign shall bear the name of the built-up area. It may be replaced by signs E-07.3 or E-07.5.

Image of an example of E-07.1



END OF A BUILT-UP AREA

E-07.2 notifies road users about the end of a built-up area and that the regulations imposed by the sign E-07.1 cease to apply. This sign shall be identical to E-07.1 except that it shall be crossed by a diagonal red band or, preferably, red parallel lines forming such a band running from the upper right edge to the lower left edge. The diagonal band may be interrupted when crossing the name of the built-up area. If not interrupted, the diagonal band shall be placed over the name of the built-up area.

Image of an example of E-07.2



BEGINNING OF A BUILT-UP AREA

E-07.3 notifies road users about the beginning of a built-up area where special regulations governing traffic in built-up areas in the territory of the State apply. This sign shall bear the symbol of the built-up area. It may be replaced by signs E-07.1 or E-07.5.

Image of E-07.3

**END OF A BUILT-UP AREA**

E-07.4 notifies road users about the end of a built-up area and that the regulations imposed by the sign E-07.3 cease to apply. This sign shall be identical to E-07.3 except that it shall be crossed by a diagonal red band or, preferably, red parallel lines forming such a band running from the upper right edge to the lower left edge. The diagonal band may be interrupted when crossing the symbol of the built-up area. If not interrupted, the diagonal band shall be placed over the symbol of the built-up area.

Image of E-07.4

**BEGINNING OF A BUILT-UP AREA**

E-07.5 notifies road users about the beginning of a built-up area where special regulations governing traffic in built-up areas in the territory of the State apply. This sign shall bear the name and the symbol of the built-up area. It may be replaced by signs E-07.1 or E-07.3.

Image of an example of E-07.5

**END OF A BUILT-UP AREA**

E-07.6 notifies road users about the end of a built-up area and that the regulations imposed by the sign E-07.5 cease to apply. This sign shall be identical to E-07.5 except that it shall be crossed by a diagonal red band or, preferably, red parallel lines forming such a band running from the upper right edge to the lower left edge. The diagonal band may be interrupted when crossing the name and the symbol of the built-up area. If not interrupted, the diagonal band shall be placed over them.

Image of an example of E-07.6



~~(b) The sign showing the end of a built-up area shall be identical except that it shall be crossed by an oblique bar coloured red or consisting of parallel lines coloured red running from the upper right edge to the lower left edge. Signs E, 8a; E, 8b; E, 8c and E, 8d are examples of signs indicating the end of a built-up area.~~

Notwithstanding the provisions of Article 6, paragraph 1 of this Convention these signs **indicating the end of a built-up area** may be placed on the reverse side of signs identifying a built-up area.

~~(c) The signs covered by this paragraph shall be used in conformity with the provisions of the Convention, Article 13 bis, paragraph 2.~~

The regulations governing traffic in built-up areas may be supplemented by different regulations notified by other signs on certain sections of road in the built-up area. However, sign B-03.2 shall always be placed on a priority road marked with sign B-03.1 if that road ceases to have priority where it passes through the built-up area.

The provisions of section G, subsection I, paragraphs 4 to 7 apply to signs indicating the beginning and the end of a built-up area.

8. Signs having zonal validity

(a) Beginning of a zone

BEGINNING OF A ZONE

E-08.1 notifies road users of a beginning of a zone where restrictions, prohibitions or obligations indicated by the regulatory sign displayed on this sign apply to all the interconnecting roads (at least two) in the zone.

~~(i) To indicate that a sign applies to all roads in a zone (zonal validity), the~~ **This sign shall be displayed on a rectangular panel-rectangle with a light-coloured ground. It preferably should bear the word inscription "ZONE" or its equivalent in the national language may be displayed above or below the sign on the panel. Specific details of the restrictions, prohibitions or obligations indicated by the sign may be given below the sign on the panel inscribed in the lower part of the sign or on an additional panel. The inscriptions shall be black or dark blue.**

~~Signs applying to all roads in a zone (zonal validity)~~ **This sign shall be set up at all roads giving access to the zone concerned. The zone preferably should only include roads which have similar characteristics.**

~~(ii) Signs E, 9a; E, 9b; E, 9c and E, 9d are examples of signs applying to all roads in a zone (zonal validity):~~

~~E, 9a—Zone in which parking is prohibited;~~

~~E, 9b—Zone in which parking is prohibited at certain times;~~

~~E, 9c—Parking zone;~~

~~E, 9d—Maximum speed zone.~~

(b) Exit from a zone

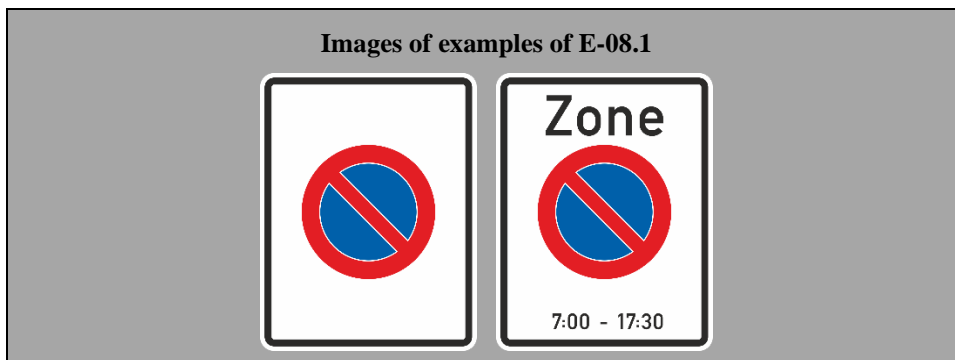

EXIT FROM A ZONE

E-08.2 notifies road users of the exit from a zone in which a sign has zonal validity E-08.1. This sign shall be similar to the E-08.1 sign except that the regulatory sign displayed on E-08.1 shall be of grey colour and a black diagonal band or, preferably, parallel black lines forming such a band shall run from the upper right edge to the lower left edge. The diagonal band may be interrupted when crossing the displayed grey regulatory sign. If not interrupted, the diagonal band shall be placed over it.

(i) To indicate the exit from a zone in which a sign has zonal validity, the same sign displayed on a rectangular panel shall be set up as that placed at the entry to the zone but it shall be grey on a rectangular panel with a light coloured ground. A black or dark grey diagonal band or parallel grey or black lines forming such a band shall slope downwards across the sign from right to left.

Signs indicating the exit from a zone It shall be set up on all roads which may be used to leave that zone.

(ii) Signs E, 10a ; E, 10c and E, 10d are examples of signs indicating the exit from a zone in which a sign applies to all roads (zonal validity):

E, 10a – End of zone in which parking is prohibited;

E, 10b – End of zone in which parking is prohibited at certain times;

E, 10c – End of parking zone;

E, 10d – End of maximum speed zone.

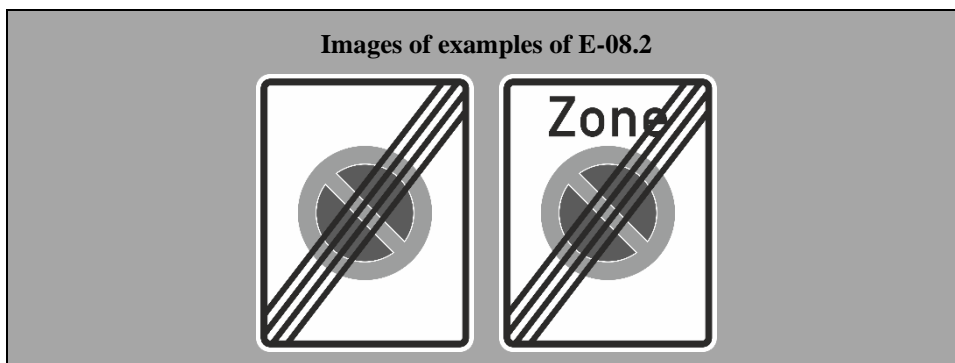

9. Signs notifying the entry to or exit from a tunnel where special rules apply

TUNNEL

(a) Sign E, 11a ‘TUNNEL’ **E-09.1** notifies of indicates a section of road passing through a tunnel and on which special traffic rules apply. It is placed at the point from which these rules apply. **The sign shall be used for tunnels of 1,000 m or more and in cases provided for by domestic legislation. The length of such a tunnel shall be included either in the lower part of the sign or on an additional panel H-02.0 as described in section H, subsection II**

paragraph 1. The name of the tunnel may be placed on an additional panel or on the sign itself.

The sign shall have a blue or green ground, and the symbol shall be white and black or white and dark blue.

(b) In order to warn road users in advance, sign ~~E, 11a~~ **E-09.1** may be placed in addition, at a suitable distance before the point where the special rules apply; such sign shall show, either in its lower part, or on an additional panel ~~H, 1H-01.0~~, as described in **section H, subsection II paragraph 1** ~~paragraph 2 (a) of this Annex~~, the distance between the point at which it is set up and the point from which these special rules apply.

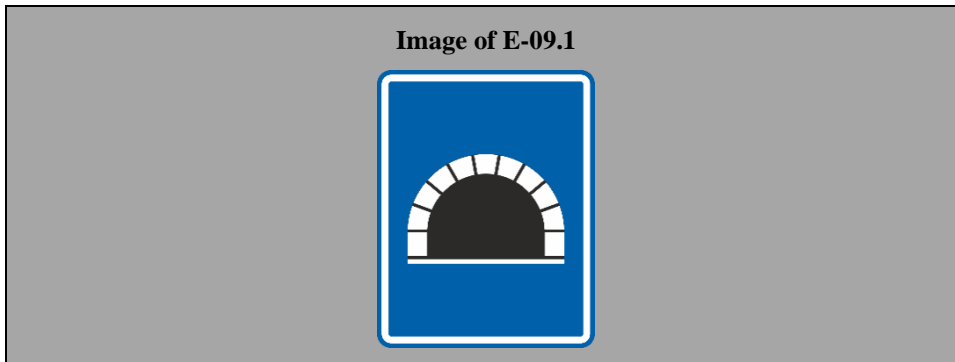

END OF TUNNEL

(c) ~~Sign E, 11b 'END OF TUNNEL'~~ **E-09.2** notifies that the special traffic rules imposed by sign E-09.1 may be placed at the point from which the special rules no longer cease to apply from the point of its placement. This sign shall be identical to E-09.1 except that it shall be crossed by a diagonal red band or, preferably, red parallel lines forming such a band running from the upper right edge to the lower left edge. The diagonal band may be interrupted when crossing the symbol. If not interrupted, the diagonal band shall be placed over the symbol.

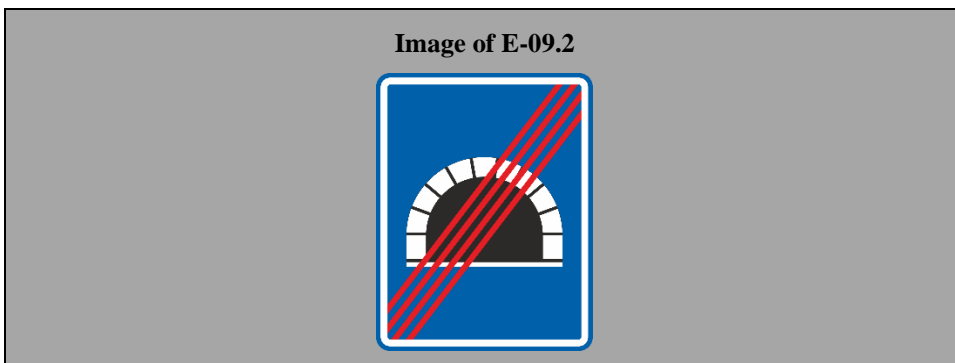

10. "PEDESTRIAN CROSSING" Pedestrian crossing sign

PEDESTRIAN CROSSING

(a) ~~Sign E, 12 a, "PEDESTRIAN CROSSING", E-10.0~~ **E-10.0** notifies road users of ~~is used to show pedestrians and drivers~~ the position of a pedestrian crossing. The ground of ~~the panel~~ **this sign** shall be blue ~~or black with the triangle a~~ white or yellow **triangle**, and ~~the symbol shall be black or dark blue.~~ **the This symbol shall** ~~symbol displayed shall be a pedestrian on a crossing marked by broad stripes.~~ ~~symbol as A, 12 a (A 12.1).~~ **The symbol on this sign may be reversed.**

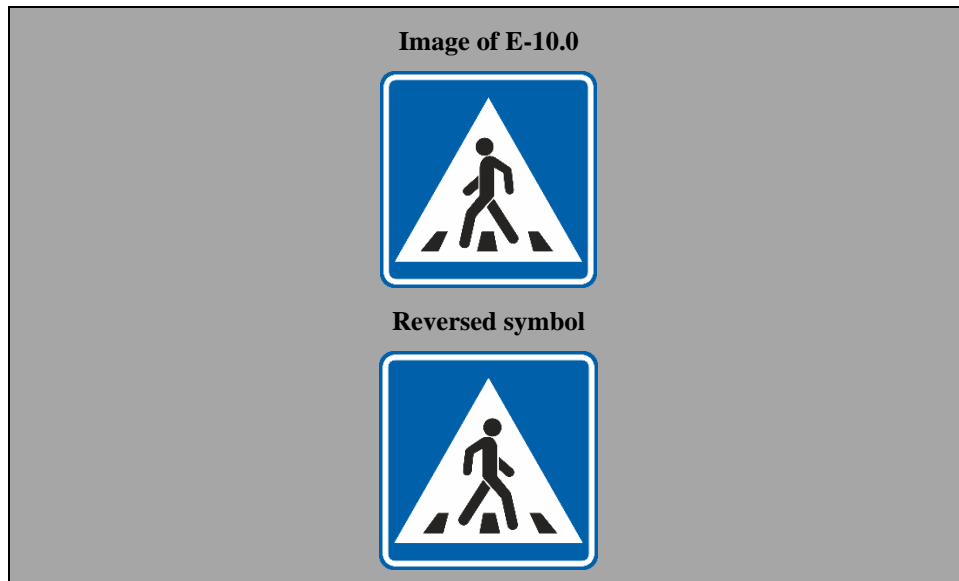

~~(b) — However, the sign E, 12b, having the shape of an irregular pentagon, a blue ground and a white symbol or the sign E, 12c, having a dark ground and white symbol may also be used.~~

The pedestrian crossing signs shall be placed at pedestrian crossings when the competent authorities consider it advisable.

11. ~~"HOSPITAL"~~Hospital sign

HOSPITAL

~~(a) This sign shall be used to notify drivers of vehicles that they should take the precautions required near medical establishments; in particular, that they should not make any unnecessary noise. There are two models of this sign: E, 13a and E, 13b.~~

E-11.1 notifies road users that a hospital is located nearby where they need to take the precautions required and where they shall not make any unnecessary noise. It shall have a blue ground and the symbol shall be white. It may be replaced by E-11.2.



E-11.2 notifies road users that a hospital is located nearby where they need to take the precautions required and where they shall not make any unnecessary noise. It shall have a blue ground and the symbols shall be white and red. It may be replaced by E-11.1.

~~(b) The red cross on **this sign E, 13b** may be replaced by ~~one of the symbols referred to in section F, subsection II, paragraph 1~~ a red symbol depicting first-aid stations in the States concerned.~~



12. "PARKING" Parking sign

PARKING

(a) ~~Sign E, 14 a, "PARKING", E-12.1 notifies of places which may be set up parallel to the axis of the road, shall indicate places where the parking of vehicles is authorized. The panel sign shall be square or rectangular with a blue ground and it shall bear the letter in white or ideogram used in the State concerned to denote "Parking". The ground of this sign shall be blue. This sign may be set up parallel to the axis of the road.~~

~~(b) The direction in which the parking place lies or the categories of vehicle for which it is reserved may be shown on the sign itself or on an additional panel below the sign. Such inscriptions may also limit the period for which parking is permitted or indicate that public transport is accessible from the parking place by means of a "+" sign" followed by an indication of the type of transport, in word or symbol form.~~

~~Signs E, 14b and E, 14c are examples of the signs which may be used to indicate a car park more particularly intended for vehicles whose drivers wish to use a means of public transport.~~

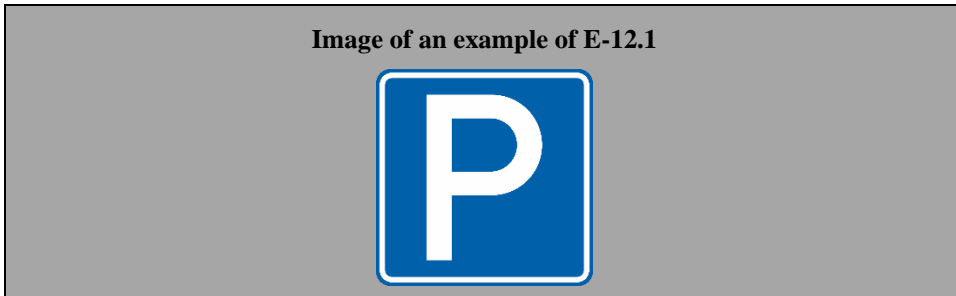

PARK AND RIDE

E-12.2 notifies of places where parking is authorized with an option to change to other transport means. The sign shall have a blue ground and shall bear a white coloured symbol "P + R" with one horizontal line placed below and one above "P + R".

In the "P + R" symbol, the letters P and R may be replaced by the letters used in the State concerned to denote "Parking" and "availability of other transport means". This sign may be replaced by E-12.3 or E-12.4.

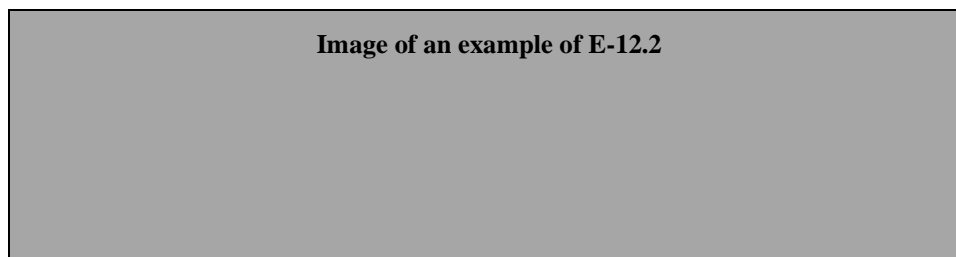



E-12.3 notifies of places where parking is authorized with an option to change to a specific means of public transport. The sign shall have a blue ground and shall bear a white coloured symbol “P +” followed by an inscription indicating the type of public transport by its name.

In the “P +” symbol, the letter P may be replaced by the letter used in the State concerned to denote "Parking". This sign may be replaced by E-12.2 or E-12.4.

Image of an example of E-12.3



E-12.4 notifies of places where parking is authorized with an option to change to a specified means of public transport. The sign shall have a blue ground and shall bear a white coloured symbol “P +” followed by a symbol indicating the type of public transport.

In the “P +” symbol, the letter P may be replaced by the letter used in the State concerned to denote "Parking". This sign may be replaced by E-12.2 or E-12.3.

Image of an example of E-12.4



13. Signs notifying a bus or tramway stop

~~E, 15 "BUS STOP" and E, 16 "TRAMWAY STOP".~~

BUS STOP

E-13.1 notifies of a location of a bus stop. Special regulations in the territories of the State concerned may apply. The symbol on this sign may be reversed.

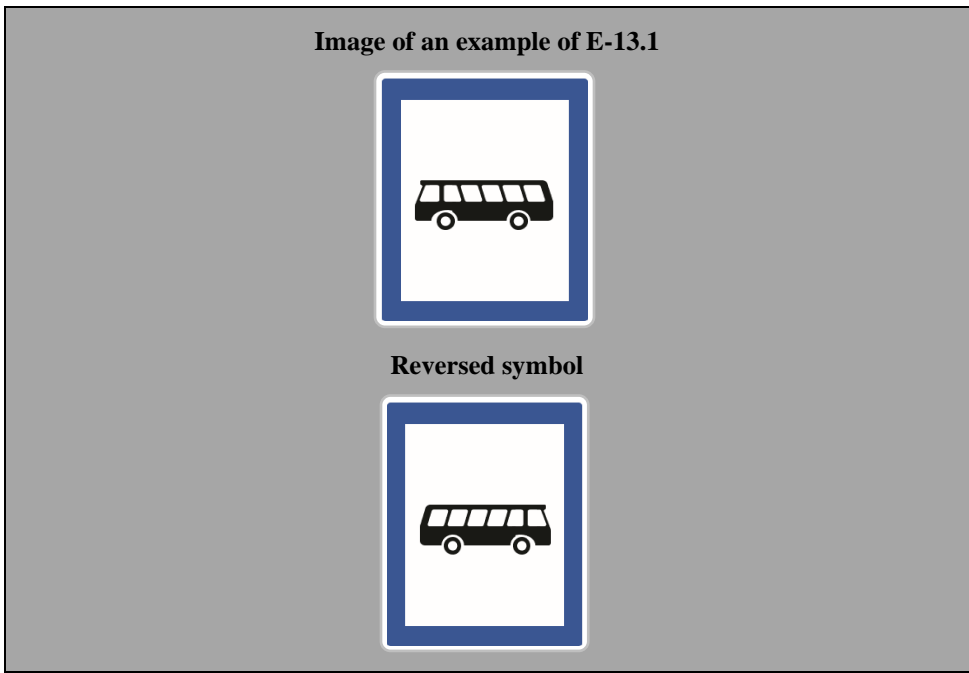

TRAMWAY STOP

E-13.2 notifies of a location of a tramway stop where special regulations in the territories of the State concerned may apply. The symbol on this sign may be reversed.

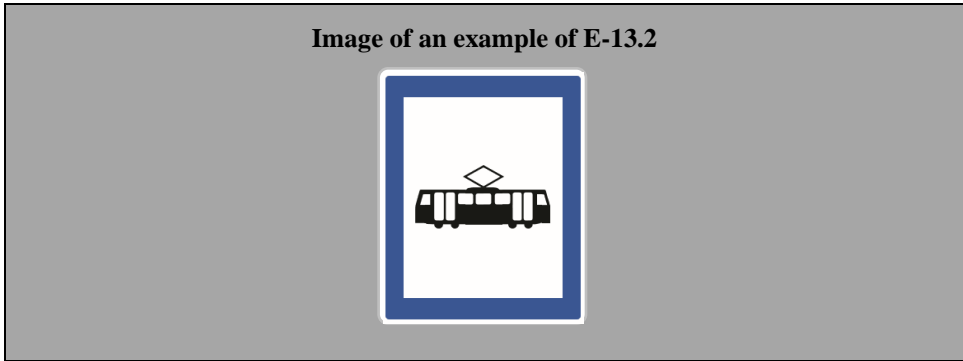

14. Signs notifying an entry to or an exit from a residential area where special traffic rules apply

RESIDENTIAL AREA

E-14.1 notifies road users about the beginning of a residential area where special regulations governing traffic in residential areas in the territory of the State apply.

This sign shall have a blue ground and white symbols.



END OF RESIDENTIAL AREA

E-14.2 notifies of the exit from a residential area where the special regulations imposed by E-14.1 cease to apply. This sign shall be identical to the sign E-14.1 except that it shall be crossed by a diagonal red band or, preferably, red parallel lines forming such a band running from the upper right edge to the lower left edge. The diagonal band shall be placed over the symbols.



145. Signs indicating a stopping place in case of emergency or danger

EMERGENCY STOPPING PLACE

Sign E, 18⁵⁵ – “EMERGENCY STOPPING PLACE” E-15.0 notifies of indicates a place which shall only be used by drivers for stopping or parking in case of emergency or danger. If this stopping place is equipped with an emergency telephone and/or an extinguisher, the sign shall bear the symbols F, 14 17 F-10.0 and/or F, 15 F-11.0 either in its lower part or on a rectangular an additional panel placed below the sign. This sign has two models, E, 18 a and E, 18 b. The symbol on this sign shall be reversed for traffic keeping to the left.

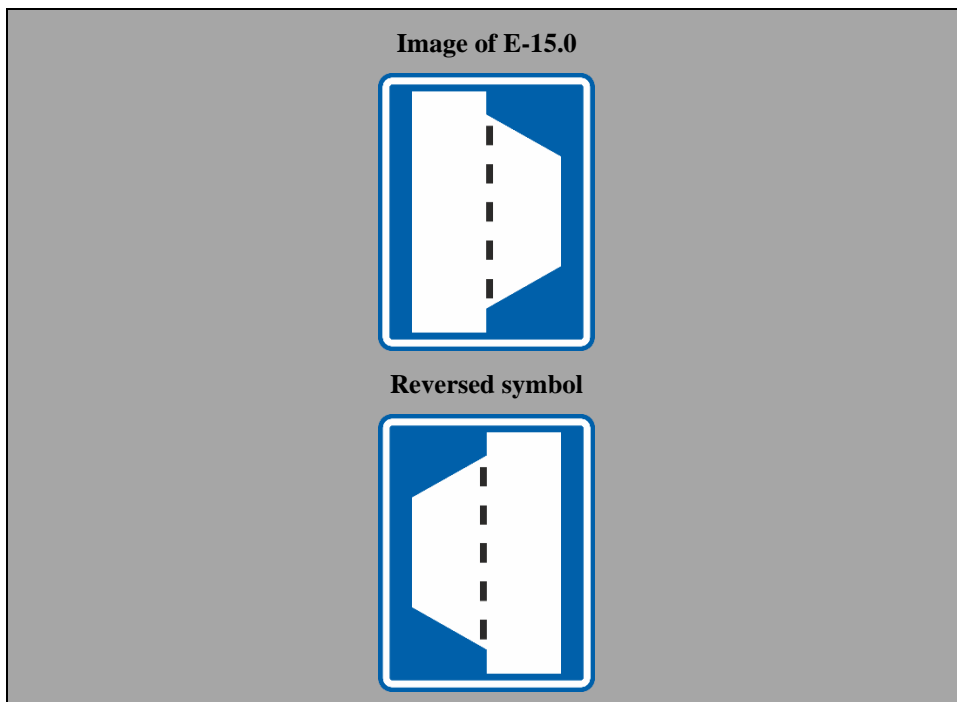

Section F

INFORMATION, FACILITIES OR SERVICE SIGNS

I. General characteristics and symbols

1. ~~“F” signs with inscriptions shall have a blue or green ground; they shall bear a white or yellow rectangle~~ **be blue or green rectangles with a white square placed in the centre** on which the symbol shall be displayed.
2. **“F” signs without inscriptions shall be blue or green squares or rectangles with a white square placed in the centre. The area of the white square shall not be greater than two-thirds of the area of the blue or green ground.**
23. ~~On the blue or green band at the bottom of the sign~~ **On the lower part of the “F” sign with inscription**, the distance to the facility indicated, or to the entry to the road leading to it, may be inscribed in white; ~~on the sign bearing symbol F, 5 the word “HOTEL” or “MOTEL” may be inscribed in the same way.~~ The signs may also be set up **along main roads or** at the entry to the road leading to the facility and may then bear a white **advance directional or directional arrow on the blue or green part at the bottom on the lower part of the sign, respectively.**
4. The symbol shall be black or dark blue, **unless otherwise indicated.** symbols F, 1 a, F, 1 b, F, 1 c and F, 18, which shall be red. The symbol F, 17 may be red.

II. Descriptions ~~Definitions~~ and images

1. ~~“FIRST AID STATION”~~ **First-aid symbol sign**

FIRST-AID STATION

F-01.0 notifies of a location of a first aid station. The symbols depicting first-aid stations in the States concerned shall be used. These symbols shall be red. ~~Examples of these symbols are F, 1a, F, 1b and F, 1c.~~

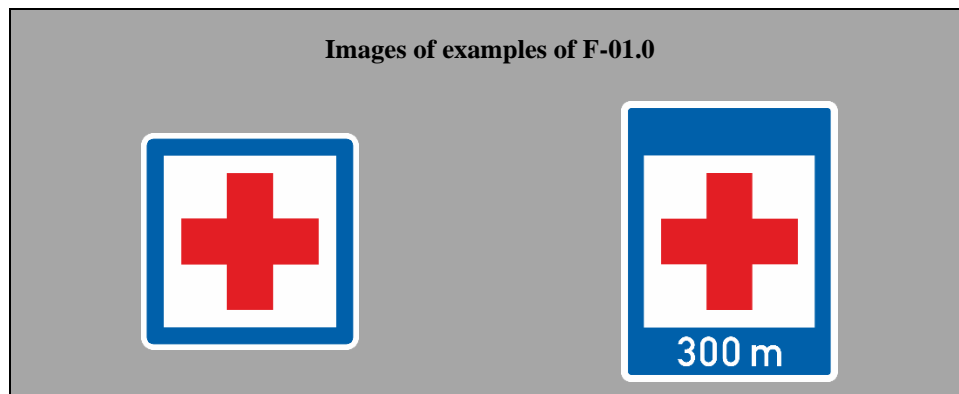

2. ~~Miscellaneous symbols~~ **Other signs**

BREAKDOWN SERVICE

~~F, 2 "BREAKDOWN SERVICE"~~ F-02.0 notifies of a location of a breakdown service.

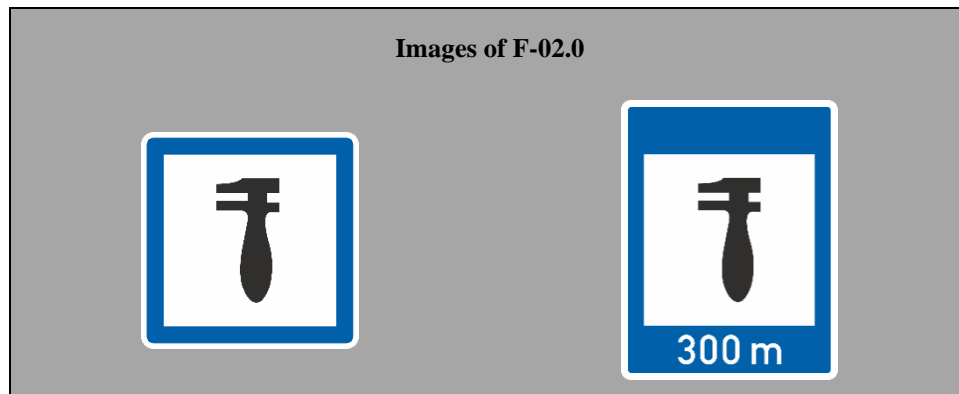

TELEPHONE

~~F, 3 "TELEPHONE"~~ F-03.0 notifies of a location of a telephone.

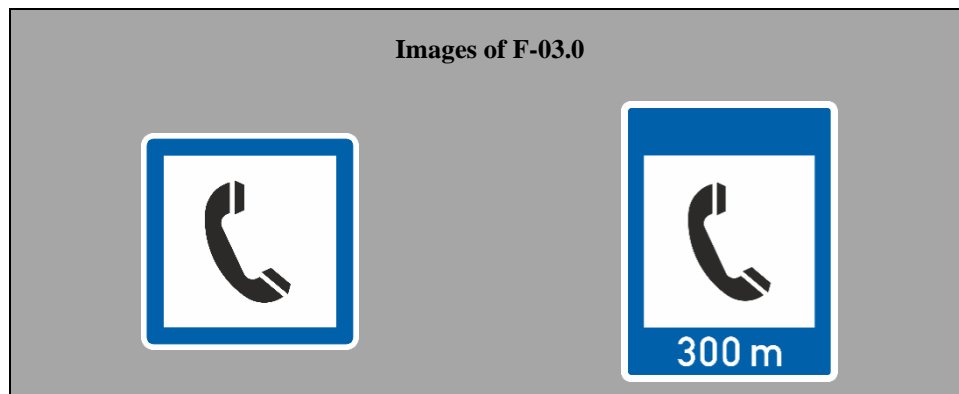

FILLING STATION

~~F, 4 "FILLING STATION"~~ F-04.0 notifies of a location of a filling station

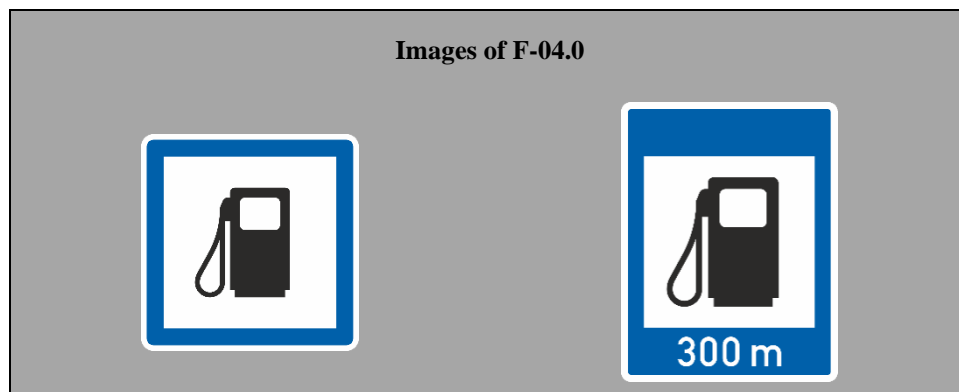

HOTEL OR MOTEL

~~F, 5 "HOTEL or MOTEL"~~ F-05.1 notifies of a location of a hotel or motel.
This sign - the variant with inscription – may contain the inscription
“HOTEL” or “MOTEL” on the lower part of the sign.

Images of F-05.1



YOUTH HOSTEL

F, 13 "YOUTH HOSTEL" F-05.2 notifies of a location of a youth hostel.

Images of examples of F-05.2

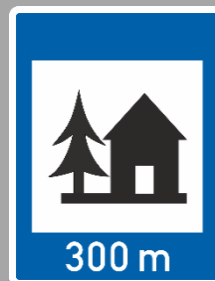

RESTAURANT

F, 6 "RESTAURANT" F-06.1 notifies of a location of a restaurant.

Images of examples of F-06.1

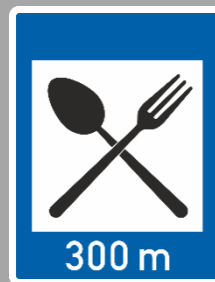

REFRESHMENTS OR CAFETERIA

~~F, 7 "REFRESHMENTS OR CAFETERIA"~~ F-06.2 notifies of the availability of refreshments or a location of a cafeteria.

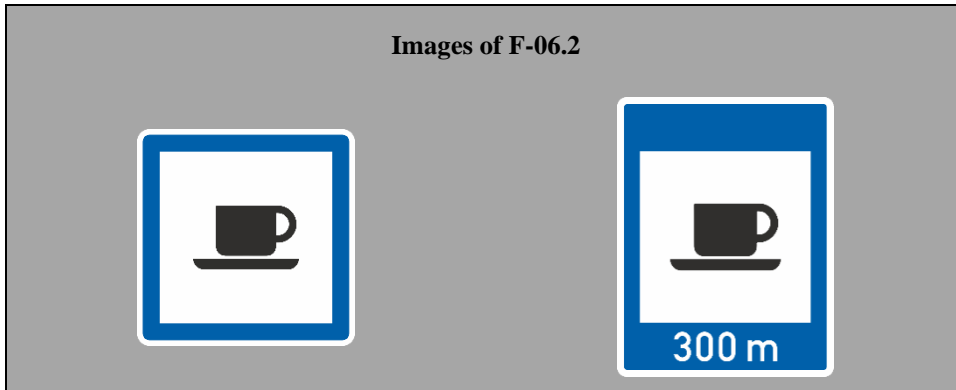

PICNIC SITE OR REST AREA

~~F, 8 "PICNIC SITE"~~ F-07.1 notifies of a location of a picnic site or a rest area.

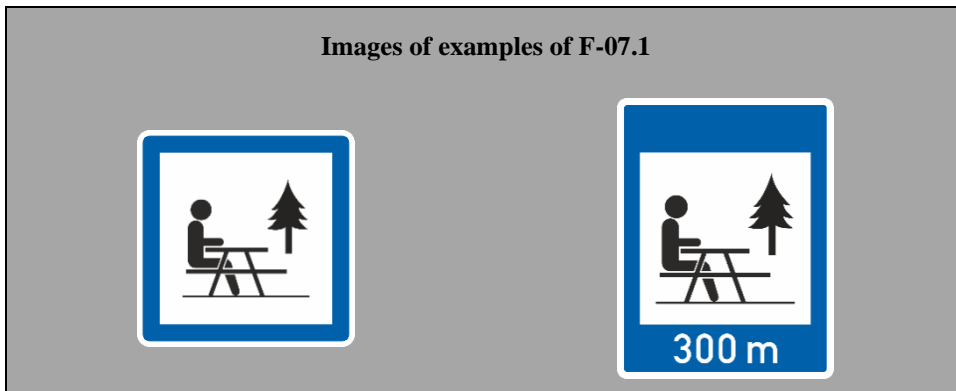

~~F, 9 "STARTING POINT FOR WALKS"~~

CAMPING SITE

~~F, 10 "CAMPING SITE"~~ F-07.2 notifies of a location of a camping site.

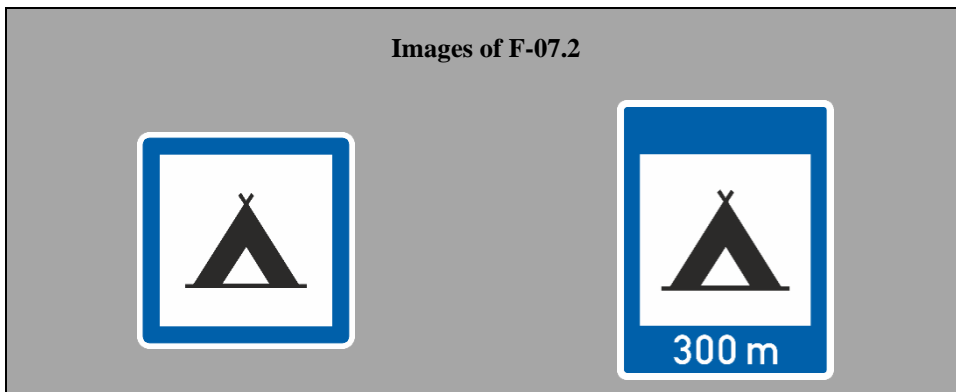

CARAVAN SITE

F-11 "CARAVAN SITE" F-07.3 notifies of a location of a caravan site.

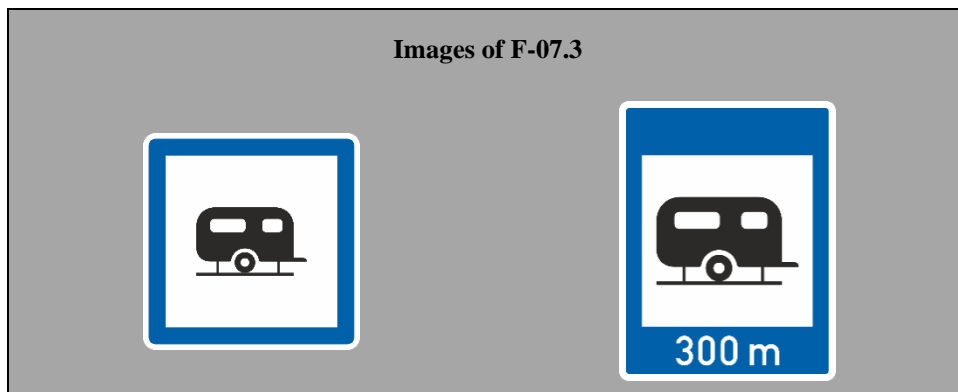

F-12 "CAMPING AND CARAVAN SITE"

RADIO STATIONS PROVIDING TRAFFIC INFORMATION

F-08.0 notifies of the frequency of a radio station that provides traffic information. The sign shall display an inscription "Radio" in a white square, which may be supplemented by the name or the code of the radio station. The inscription "Radio" may be repeated in the national language.

This sign - the variant with inscription – shall display the inscription of the frequency and, if necessary, the wavelength of the local radio station in white on the lower part of the sign. For the variant of this sign without inscription, the frequency information shall be displayed on an additional panel.

It is left to the discretion of the State concerned to add, in the case of VHF stations, the indication "MHz" or the regional code, and in the case of medium-frequency or long-frequency stations the indication "kc/s".

The wavelength may be given in figures with the letter m (e.g. 1500m).

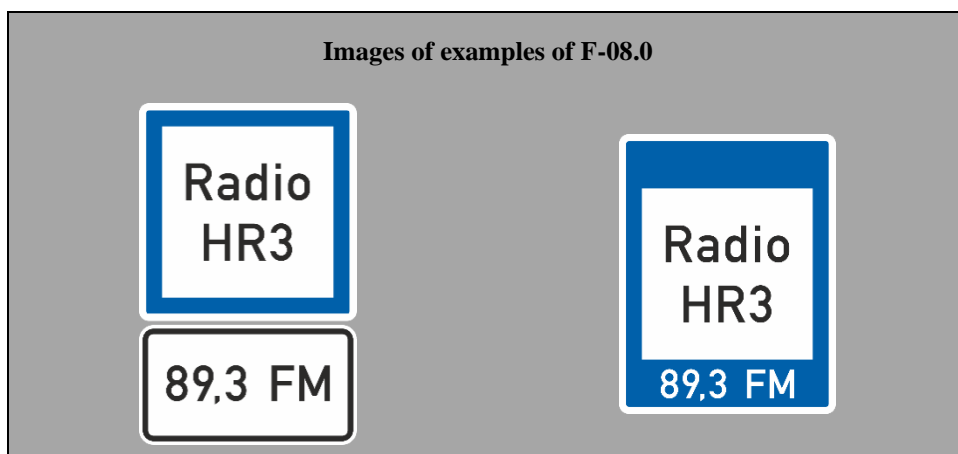

PUBLIC LAVATORY

F-09.0 notifies of a location of a public lavatory.

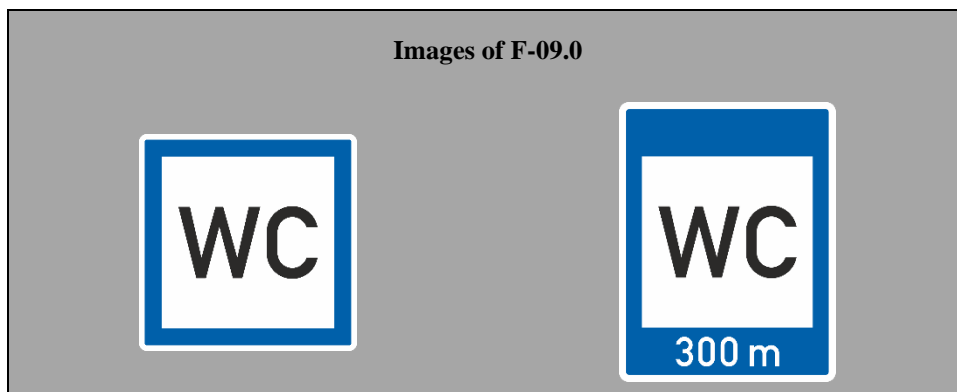
**EMERGENCY TELEPHONE**

F-17 "EMERGENCY TELEPHONE" F-10.0 notifies of a location of a telephone for emergency calls. The symbol may also be red.

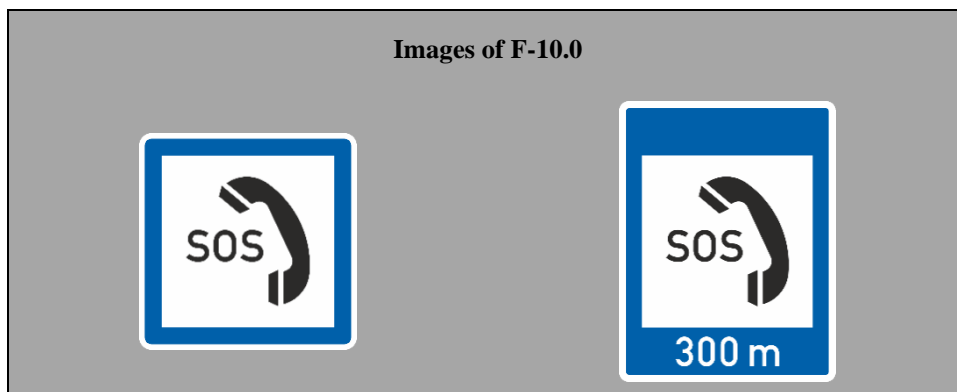
**EXTINGUISHER**

F-18 "EXTINGUISHER" F-11.0 notifies of a location of an extinguisher. The symbol shall be red.

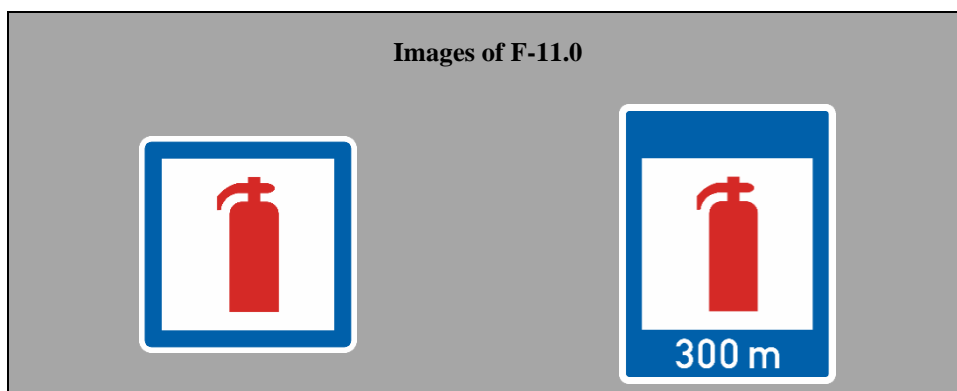

3. Multiple facilities or services signs

MULTIPLE FACILITIES OR SERVICES SIGNS

F-12.1 notifies of a location of two different types of facilities or services.

Images of examples of F-12.1

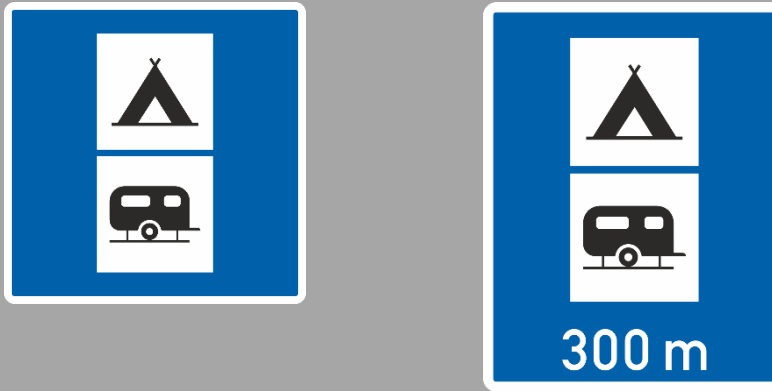

F-12.2 notifies of a location of three different types of facilities or services.

Images of examples of F-12.2

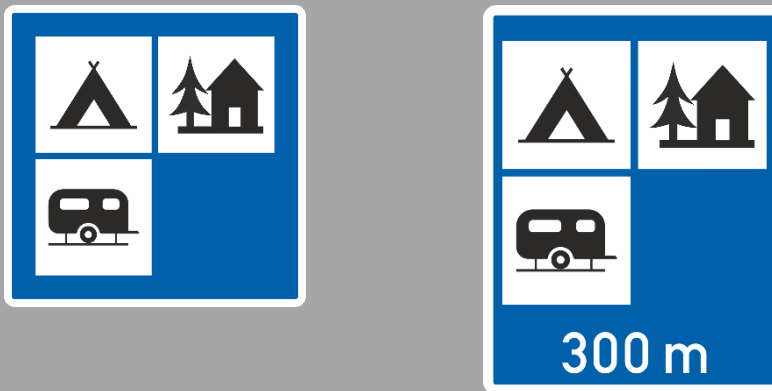

F-12.3 notifies of a location of four different types of facilities or services.

Images of examples of F-12.3

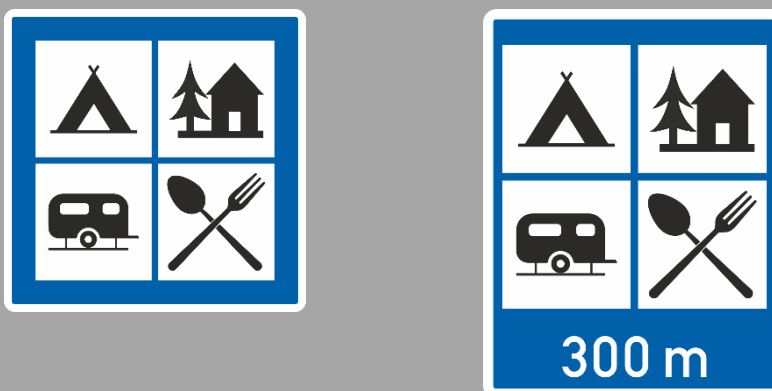

Section G

~~DIRECTION, POSITION OR INDICATION~~ OTHER INFORMATION SIGNS

I. General characteristics and symbols

1. ~~Informative~~ **Other information** signs are ~~usually~~ rectangular; however, direction signs, ~~and signs notifying the direction and distance to the nearest emergency exit and signs indicating temporary conditions due to road works or detours may be in the shape of an elongated rectangle with~~ **have** the longer side horizontal, terminating in an arrowhead.

2. ~~Informative~~ **Other information** signs shall bear either ~~white or light-coloured symbols or inscriptions on a dark ground~~ **with a white light-coloured rim**, or dark-coloured symbols or inscriptions on a white or light-coloured ground; ~~with a black dark-coloured rim~~; the colour red may be used only exceptionally and must never predominate **with the exception of the road identification signs, which may have a red ground.**

3. — ~~Advance direction signs or direction signs relating to motorways or roads treated as motorways shall bear white symbols or inscriptions on a blue or green ground. On such signs the symbols used on signs E, 5a and E, 6a may be reproduced on reduced scale.~~ **Other information signs, except the indication signs, may have different colours of ground and symbols if placed on roads of different classification or, for advance direction signs and direction signs, if pointing to different locations such as facilities or services.**

4. — ~~Signs indicating temporary conditions such as road works, diversions or detours may have orange or yellow ground with black symbols and inscriptions.~~

54. — ~~On signs G, 1; G, 4; G, 5; G, 6 and G, 10~~ **The names of localities should preferably be displayed** ~~it is recommended to show place names in the language of the country, or subdivision thereof, where they are localities referred to are situated.~~

5. **The inscriptions on other information signs in countries not using the Latin alphabet shall be displayed in both the national language and transliterated into the Latin alphabet reproducing as closely as possible the pronunciation in the national language.**

6. **In countries not using the Latin alphabet, the inscriptions transliterated in Latin characters may be displayed on the same sign as the inscriptions in the national language or, in addition, displayed on an identical sign.**

7. **A sign shall not bear inscriptions in more than two languages.**

II. ~~Advance direction signs~~ Definitions and images

1. Advance direction signs

1. — General case

Examples of advance direction signs: G, 1a; G, 1b and G, 1c.

2. — Special cases

(a) — ~~Examples of advance direction signs for "NO THROUGH ROAD": G, 2a and G, 2b~~

(b) — ~~Example of advance direction sign for route to be followed in order to turn left, where a left turn at the next intersection is prohibited: G, 3.~~

NOTE: Advance direction signs G, 1 may bear the symbols used on other signs informing road users of the characteristics of the route or of traffic conditions (for example: signs A, 2; A, 5; C, 3e; C, 6; E, 5a; F, 2).

ADVANCE DIRECTION

G-01.1 notifies of advance directions. This sign is an example of a stacked advance direction sign (two localities).

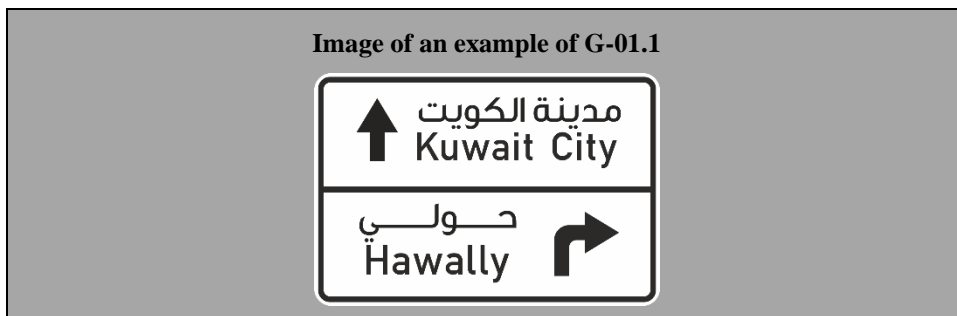

G-01.2 notifies of advance directions. This sign is an example of a stacked advance direction sign (three localities).



ADVANCE DIRECTION ON A ROUNDABOUT

G-01.3 notifies of advance directions. This sign is an example of a stacked advance direction sign (roundabout). The roundabout arrows shall be reversed for traffic keeping to the left.

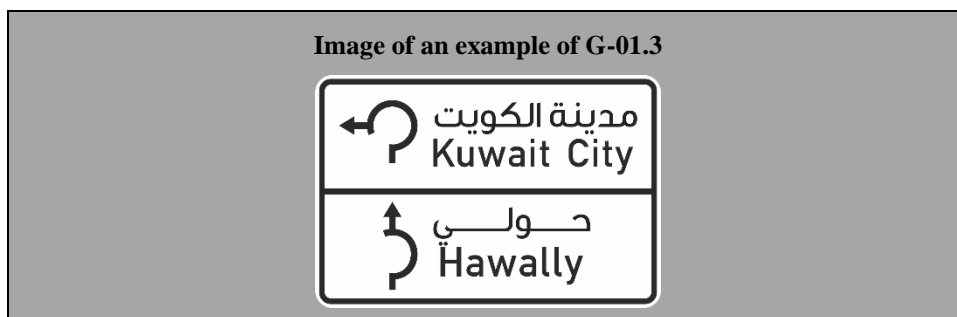

ADVANCE DIRECTION FOR AN INTERSECTION

G-02.1 notifies of advance directions. This sign is an example of an advance direction sign (intersection).

Image of an example of G-02.1

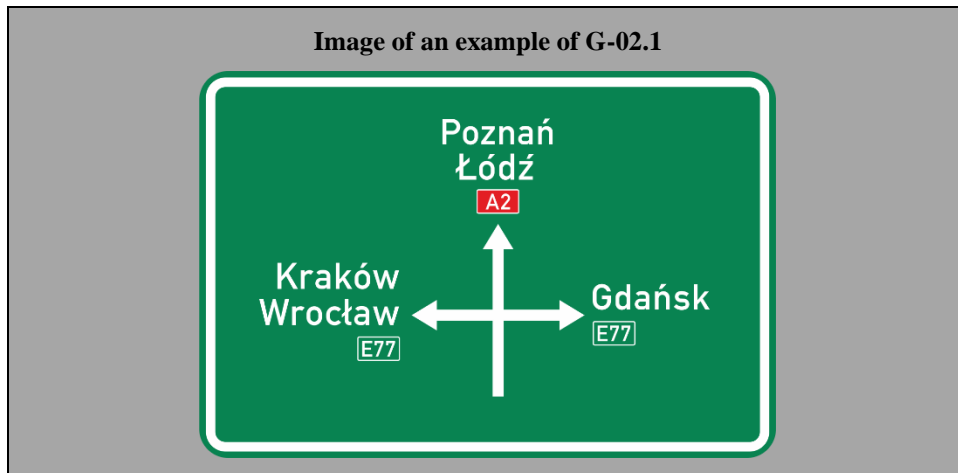
**ADVANCE DIRECTION FOR A ROUNDABOUT**

G-02.2 notifies of advance directions. This sign is an example of an advance direction sign on a roundabout. The symbol of the roundabout on this sign shall be reversed for traffic keeping to the left.

Image of an example of G-02.2

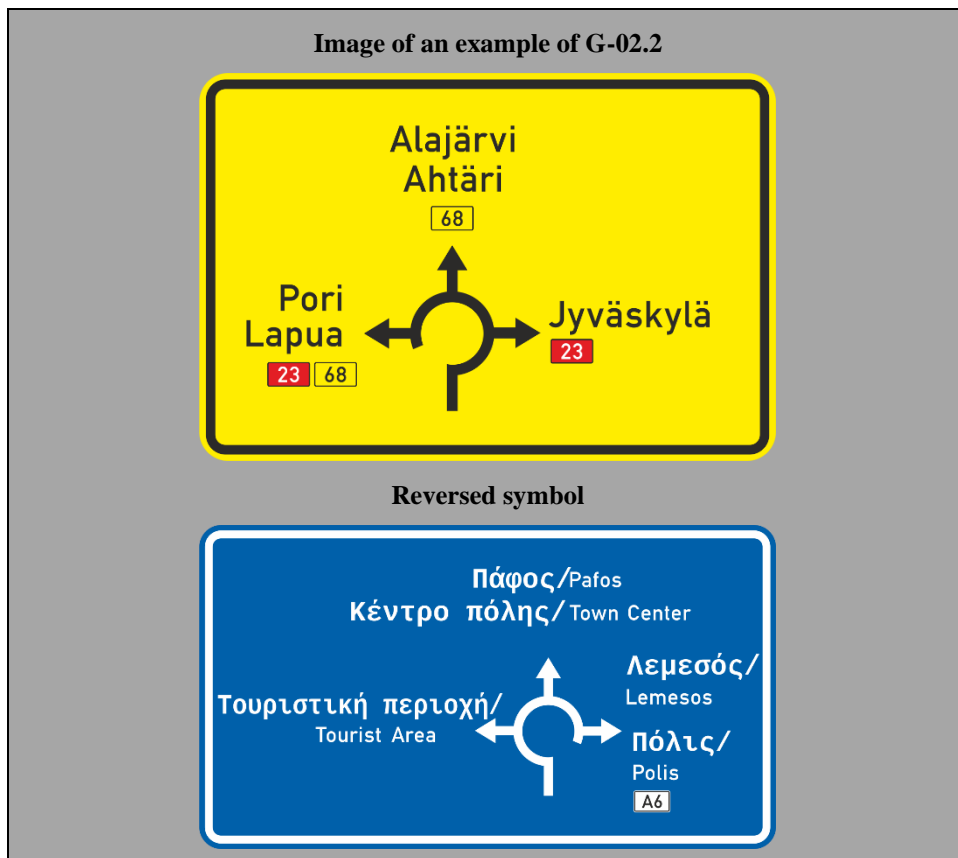

Reversed symbol

ADVANCE DIRECTION FOR LANES

G-02.3 notifies of advance directions. This sign is an example of an advance direction sign for lanes.

Image of an example of G-02.3



ADVANCE DIRECTION SIGN OVER A LANE

G-03.1 notifies of advance directions. This sign is an example of an advance direction sign for placement over a lane and may also indicate advance direction for an exit from a motorway.

Image of an example of G-03.1



ADVANCE DIRECTION SIGN OVER LANES

G-03.2 notifies of advance directions. This sign is an example of an advance direction sign for placement over a carriageway with two lanes.

Image an example of G-03.2



G-03.3 notifies of advance directions. This sign is an example of an advance direction sign for placement over a carriageway with three lanes.

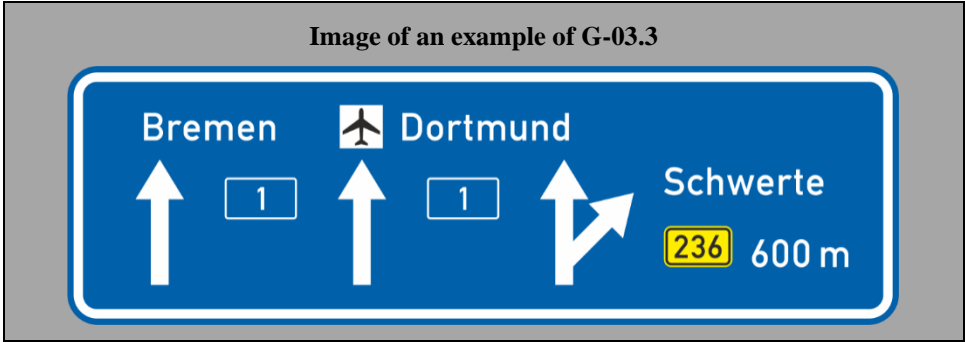

ADVANCE DIRECTION SIGN FOR NO THROUGH ROAD

G-04.1 notifies in advance of a no through road. This sign shall have a blue ground and the symbol shall be white and red.

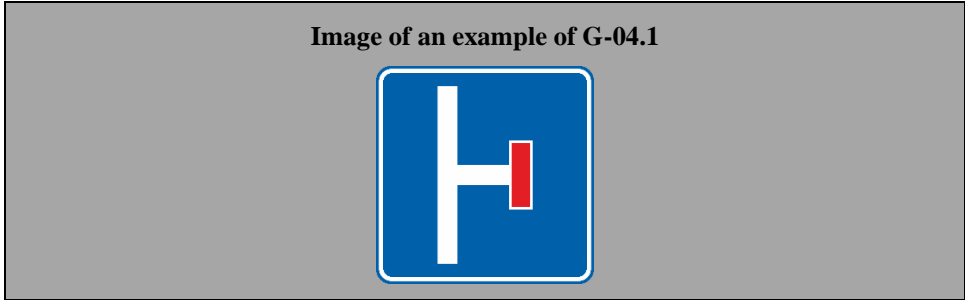

ADVANCE DIRECTION SIGN FOR PROHIBITION TO TURN

G-04.2 notifies in advance of a route to be followed in order to turn left, where a left turn at the next intersection is prohibited. The symbol shall be reversed for traffic keeping to the left.

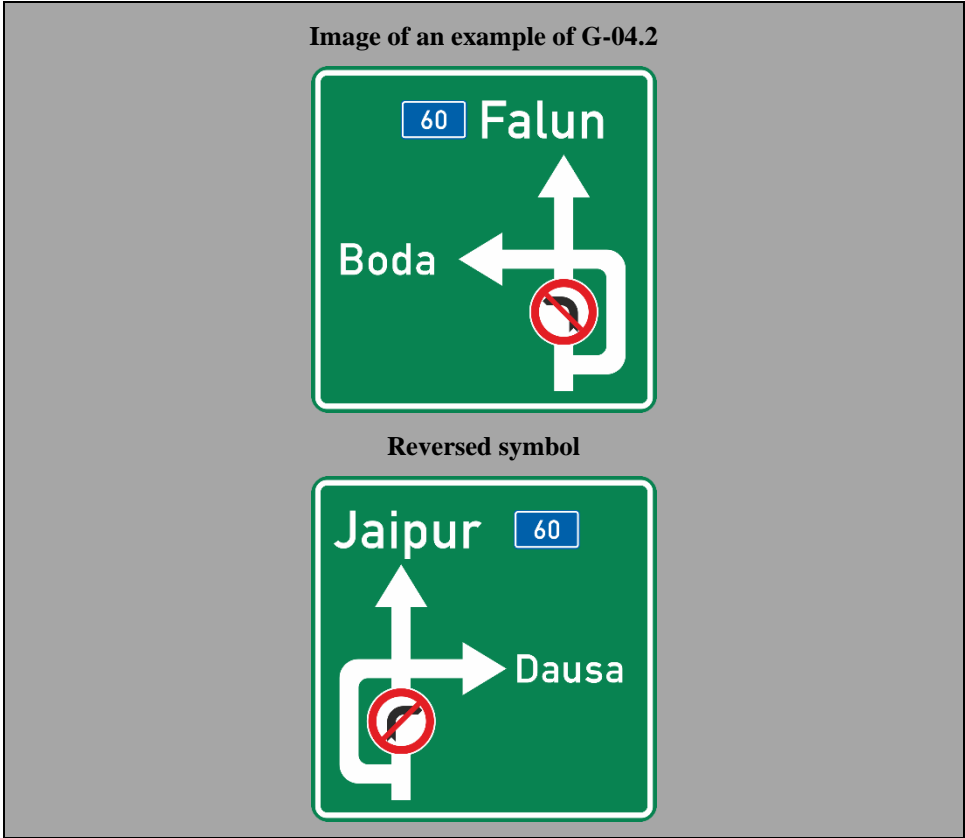

Reversed symbol

All advance direction signs may indicate the distance between the sign and the intersection or exit from a motorway on their lower half. This distance may also be shown on an additional panel placed.

All advance direction signs except G-04.1 and G-04.2 may bear the symbols used on other signs or display other signs on a reduced scale notifying road users of the characteristics of the route, traffic conditions, facilities and services, parking or road identification. Advance direction sign G-04.1 may only display the sign G-13.0 while G-04.2 may only display the sign C-11.1 or C-11.2 on a reduced scale.

III. Direction signs². Direction signs

1. — Examples of signs showing the direction of a place: G, 4a; G, 4b; G, 4c and G, 5.
2. — Examples of signs showing the direction of an airfield: G, 6a; G, 6b and G, 6c.
3. — Sign G, 7 shows the direction of a camping site.
4. — Sign G, 8 shows the direction of a youth hostel.
5. — Examples of signs showing the direction of a car parking more particularly intended for vehicles whose drivers wish to use means of public transport: G, 9a and G, 9b. The type of public transport may be indicated on the sign by an inscription or symbol.

DIRECTION SIGN

G-05.1 notifies of a left direction. This sign is an example of a direction sign showing one direction with the sign panel terminating in an arrowhead to the left.

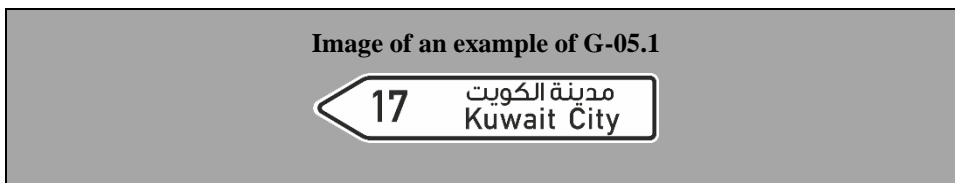

G-05.2 notifies of a right direction. This sign is an example of a direction sign showing one direction with the sign panel terminating in an arrowhead to the right.

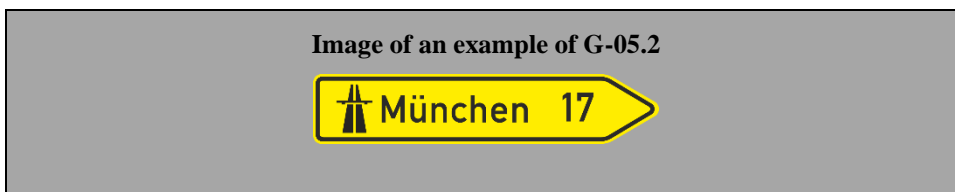

G-05.3 notifies of a direction. This sign is an example of a direction sign showing one direction with an arrow.

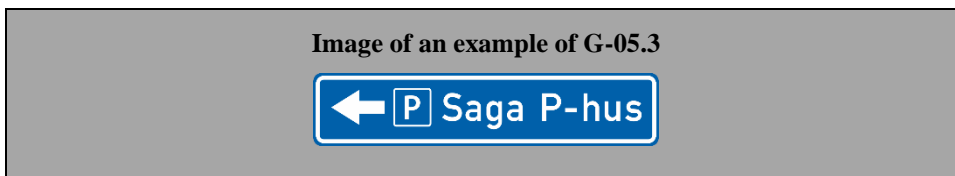

G-05.4 notifies of a left direction. This sign is an example of a direction sign showing one direction with the sign panel terminating in an arrowhead to the left.

Image of an example of G-05.4



G-05.5 notifies of a right direction. This sign is an example of a direction sign showing one direction with the sign panel terminating in an arrowhead to the right.

Image of an example of G-05.5



G-05.6 notifies of a direction. This sign is an example of a direction sign showing one direction with an arrow.

Image of an example of G-05.6



MULTIPLE DIRECTIONS SIGN

G-06.1 notifies of more than one direction. This sign is an example of a direction sign showing two directions with arrows.

Image of an example of G-06.1



G-06.2 notifies of more than one direction. This sign is an example of a direction sign showing three directions with arrows.

Image of an example of G-06.2



DIRECTION SIGN OVER A LANE

G-07.0 notifies of a direction. This sign is an example of a direction sign for placement over a lane.

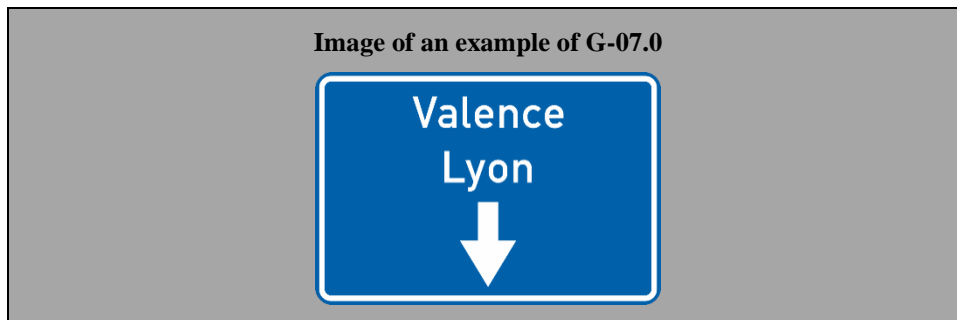

Any direction sign bearing the names of several places shall show them one below the other. The size of letters used for one place may be larger than those used for the others, only if the place in question is the largest.

When distances are displayed, the figures expressing them should preferably be inscribed at the same height as the place name. On direction signs which are arrow-shaped, these figures should preferably be placed between the place name and the point of the arrow; on rectangular-shaped signs, they should preferably be placed after the place name.

NOTE: Direction signs G, 4; G, 5 and G, 6 may bear the symbols used on other signs informing road users of the characteristics of the route or traffic conditions (for example: signs A, 2; A, 5; C, 3e; C, 6; E, 5a; F,2)

Direction signs may bear the symbols used on other signs or display other signs in a reduced scale notifying road users of the characteristics of the route or, traffic conditions, facilities and services, parking or road identification. The signs may also indicate the categories of vehicles to which they apply.

When other symbols or signs on a reduced scale are displayed, they shall be placed at the sign end opposite to where the direction is shown.

3. Road identification signs

ROAD IDENTIFICATION

G-08.0 identifies the road by its number or name. This sign is an example of a road identification sign of a rectangular shape bearing a road number.

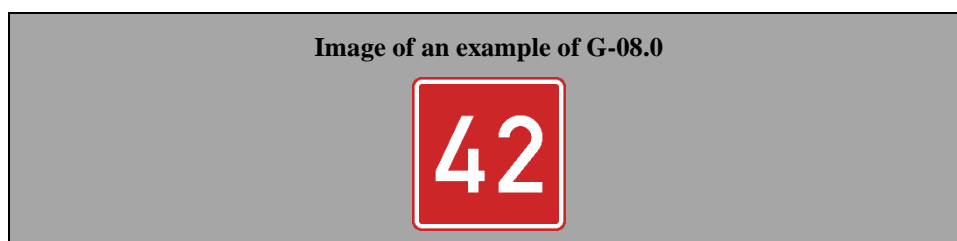

4. Place identification signs

PLACE IDENTIFICATION

G-09.0 identifies a place, other than a built-up area, by its name. This sign may additionally bear a symbol for the place. It shall indicate on-site point without the need to specify its end.

Image of an example of G-09.0



IV5. Confirmatory signs

Sign G, 10 is an example of a confirmatory sign.

PLACE CONFIRMATION

G-10.1 confirms the directions and distances to places. This sign is an example that displays the names of places and distances.

Image of an example of G-10.1

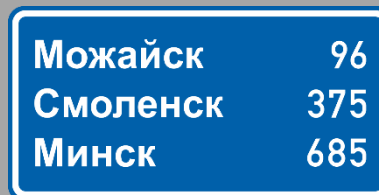

G-10.2 confirms the directions and distances to places. This sign is an example that displays the names of places and distances.

Image of an example of G-10.2



Confirmatory signs shall display the name of one or more places. Confirmatory signs displaying names of several places shall show them one below the other. The size of letters used for one place may be larger than those used for the others, only if the place in question is the largest.

Where distances are shown, the figures expressing them shall be indicated after the names of the places.

Confirmatory signs may bear the symbols used on other signs or display other signs on a reduced scale, for example road identification signs.

Notwithstanding the provisions of Article 6, paragraph 1, of this Convention, this sign may be placed on the reverse side of another sign intended for traffic proceeding in the opposite direction.

V6. Indication signs

Indication signs, unless specified otherwise, shall have a blue ground and white symbols or inscriptions. When rims at the edge are used, they shall be white.

1A. Signs indicating the number and direction of traffic lanes

DIRECTION OF LANES

Signs such as G, 11a; G, 11 b and G, 11c shall be used to notify **G-11.1** notifies drivers about the number and direction of lanes. They must comprise the same number of arrows as the number of lanes allocated to traffic in the same direction; they may also indicate lanes allocated to oncoming traffic. **This sign is an example of a sign indicating the direction of lanes and showing an incoming lane.**

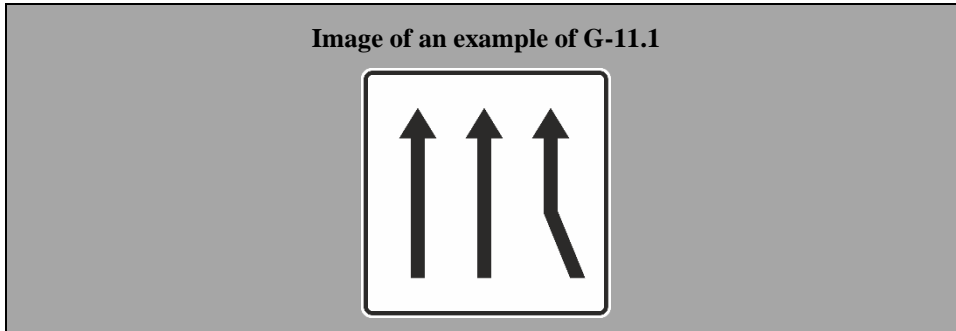

G-11.2 notifies drivers about the number and direction of lanes. This sign is an example of a sign indicating the direction of lanes and showing a lane which continues on the left side of an island or road divider.

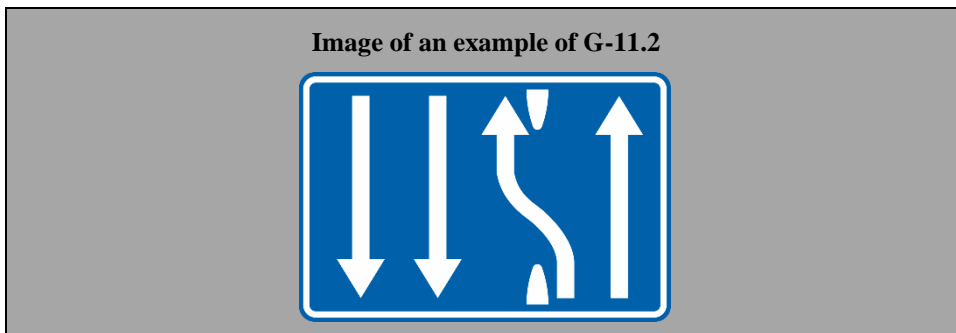

These signs for directions of lanes shall comprise the same number of arrows as the number of lanes allocated to traffic in the same direction; they may also indicate lanes allocated to oncoming traffic. These signs shall bear either light-coloured symbols on a dark ground, or dark-coloured symbols on a light-coloured ground.

2B. Signs indicating the end or closure of a lane

END OR CLOSURE OF A LANE

Signs such as G, 12a, and G, 12b shall be used to notify **G-12.1** notifies drivers about the end or the closure of a lane. **Road markings may be included. This sign is an example of a sign which indicates the end or closure of a lane by showing the end or closure with a curved arrow.**

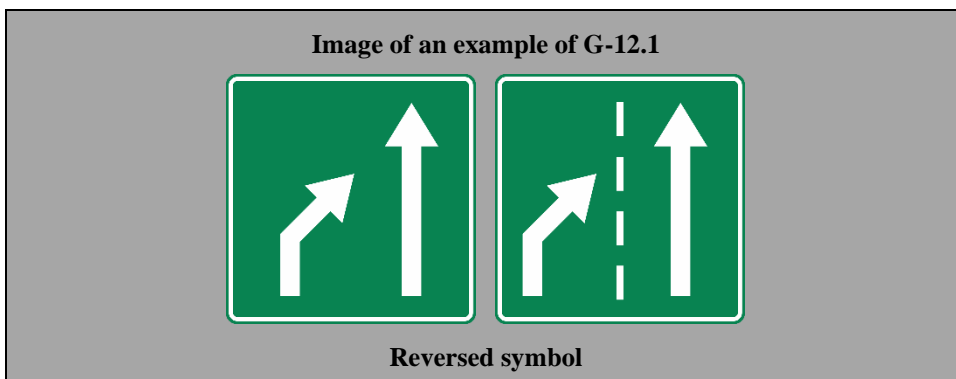

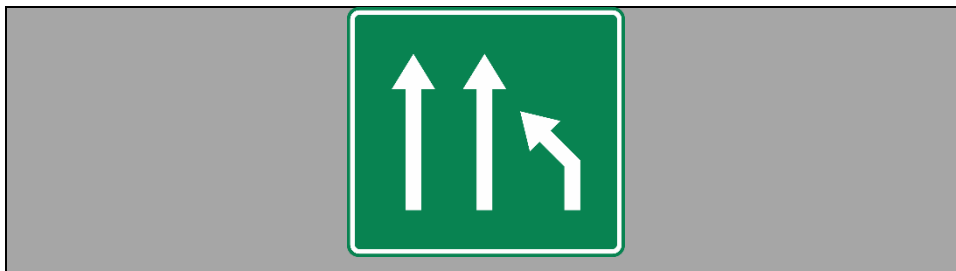

G-12.2 notifies drivers about the end or closure of a lane. This sign is an example of a sign which indicates the end or closure of a lane by showing the end or closure with a curved line.

Image of an example of G-12.2



G-12.3 notifies drivers about the end or closure of a lane. Road markings may be included. This sign is an example of a sign which indicates the end or closure of a lane by showing the end or closure with a bar instead of an arrowhead.

Image of an example of G-12.3

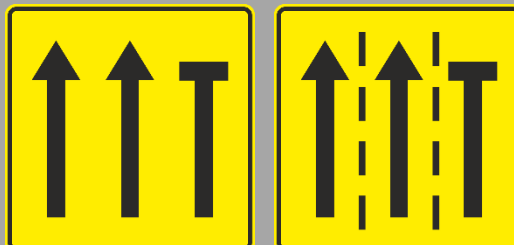

These signs for end or closure of lanes must comprise the same number of arrows as the number of lanes allocated to traffic in the same direction; they may also indicate lanes allocated to oncoming traffic. These signs for end or closure of a lane shall bear either light-coloured symbols on a dark ground, or dark-coloured symbols on a light-coloured ground. Road markings may be included.

3. "NO THROUGH ROAD"C. No through road sign

NO THROUGH ROAD

Sign G, 13, "NO THROUGH ROAD", placed at the entry to a road, shall mean that there is no throughway. G-13.0 indicates a "no through road". It shall be placed at the entry to that road. The symbol shall be white and red, exceptionally the symbols of road users may be used on the sign to indicate a "through road" for them.

Image of G-13.0



4D. “GENERAL SPEED LIMITS”General speed limits sign

GENERAL SPEED LIMITS

~~Sign G, 14 “GENERAL SPEED LIMITS”, shall be used, especially near national frontiers, to notify~~ **G-14.0 notifies road users about** the general speed limits in force in a country or in a subdivision of that country. **It shall be used, in particular at national borders.** The name or distinguishing sign of the country, possibly accompanied by the national emblem, shall be placed at the top of the sign. On the sign, the general speed limits in force in a country will be displayed in the following order: (1) in built-up areas; (2) outside built-up areas; (3) on motorways. If appropriate, the symbol of sign ~~E, 6a~~ **E-06.1**, “Road for motor vehicles”, may be used to indicate the general speed limit on roads for motor vehicles.

~~The border ground of the sign and its upper part shall be blue; the country name and the ground of the three squares rectangles within the sign, preferably not more than four, shall be in white. The symbols used in the upper and central squares-rectangles shall be in black and the symbol in the central square shall have an oblique red line across it display the sign E-07.3 or its symbol, and the sign E-07.4, or its symbol, respectively.~~

Image of an example of G-14.0



5E. “ROAD OPEN OR CLOSED”Road open or closed sign

ROAD OPEN OR CLOSED

~~(a) Sign G, 15 “ROAD OPEN OR CLOSED”, shall be used to show whether~~ **G-15.0 notifies drivers whether** a mountain road, particularly a section leading over a pass, is open or closed; the sign shall be placed at the entry to the road or roads leading to the section in question.

The name of the section of road (or pass) shall be inscribed in white. ~~On the sign shown, the name Furka is given as an example, for example~~ **“Furka”**.

~~Panels~~ **Rectangles** 1, 2 and 3 shall be removable.

(b) — If the section of the road is closed, ~~panel-rectangle~~ **1** shall be red and shall bear the inscription “CLOSED”; if the section is open, ~~panel-rectangle~~ **1** shall be green and shall bear the inscription “OPEN”. The inscriptions shall be in white ~~and preferably in several languages~~.

(c) — ~~Panels~~ **Rectangles** 2 and 3 shall have a white ground with **black** inscriptions and symbols ~~in black~~.

If the section of road is open, ~~panel-rectangle~~ **3** shall remain blank and ~~panel-rectangle~~ **2**, according to the **state condition** of the road, shall either be blank, or display sign ~~D, 9D-07.1, “SNOW CHAINS COMPULSORY”, and/or display symbol sign G, 16G-16.0. “CHAINS OR SNOW TYRES RECOMMENDED”~~. This symbol shall be black.

If the section of road is closed, ~~panel-rectangle~~ **3** shall show the name of the place up to which the road is open and ~~panel-rectangle~~ **2** shall display, according to the **state condition** of the road, either the inscription “OPEN AS FAR AS” ~~or symbol G, 16, or signs D, 9 D-07.1 and/or G, 16 G-16.0. Rectangle 3 may also display other danger warning signs.”~~

Image of an example of G-15.0

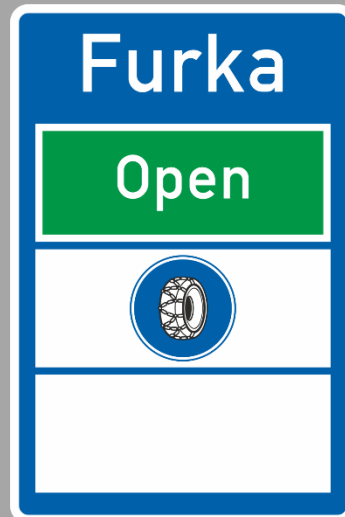

F. Advisory snow tyres or snow chains sign

ADVISORY SNOW TYRES OR SNOW CHAINS

G-16.0 notifies drivers that their vehicles should have snow tyres fitted to all wheels or to have snow chains fitted to at least two of their driving wheels. The snow tyres are recommended to be used in snow conditions.

Image of G-16.0



6G. "ADVISORY SPEED" Advisory speed sign**ADVISORY SPEED**

Sign G, 17 "ADVISORY SPEED" shall be used to show **G-17.0 notifies drivers of** the speed at which it is advisable to drive if circumstances permit and if the driver is not required to comply with a lower limit specific to his category of vehicle. The figure or range of figures appearing on the sign shall indicate the speed in the unit of measurement most commonly used to express the speed of vehicles in the country concerned. ~~This unit may be specified on the sign.~~ **That unit of measurement may be shown on the sign after or below the digit.**

Image of an example of G-17.0

7H. Sign notifying advised itinerary for heavy vehicles**ADVISED ITINERARY**

G, 18 "ADVISED ITINERARY FOR HEAVY VEHICLES" **G-18.0 notifies of an advised itinerary for the type of road user indicated by the symbol displayed on the sign.**

Image of an example G-18.0

8I. Sign notifying an escape lane**ESCAPE LANE**

Sign G, 19 "ESCAPE LANE" shall be used to indicate **G-19.0 notifies drivers of** an escape lane on a steep descent. This sign, with ~~a plate showing an additional panel displaying~~ **an additional panel displaying** distance to the escape lane, should be placed in conjunction with sign A, 2 **A-02.1 or A-02.2** at the top of the descent, ~~where the danger zone begins~~ and at the entry to the escape lane. Depending on the length of the descent the sign should be repeated as necessary, again with ~~an additional panel distance plate displaying the distance to the escape lane.~~ **The symbol shall be white and red.** ~~The symbol~~ It may be varied ~~corresponding to the siting~~ **depending on the location** of the escape lane in relation to the road concerned. **It shall be reversed for traffic keeping to the left.**

Image of an example of G-19.0

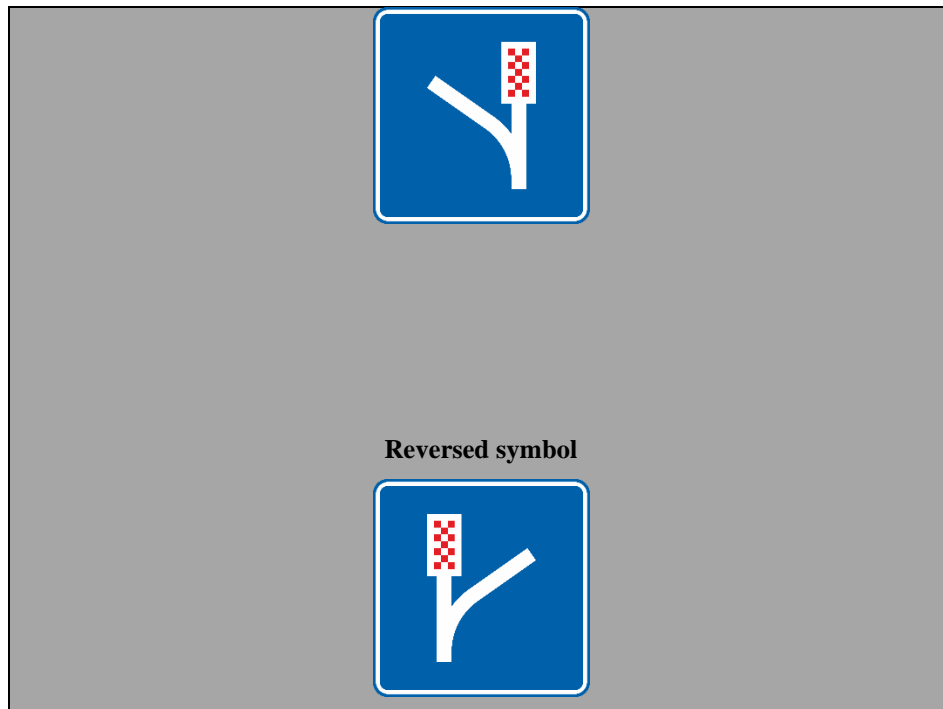

9J. Signs notifying a pedestrian overpass or underpass

OVERPASS

(a) — Sign G, 20 is used to indicate a pedestrian **G-20.1** notifies of a location of a pedestrian overpass. ~~or underpass.~~



UNDERPASS

G-20.2 notifies of a location of a pedestrian underpass.



OVERPASS WITHOUT STEPS

(b) — Sign G, 21 is used to indicate an overpass or underpass without steps. **G-21.1** notifies of a location of a pedestrian overpass without steps. The symbol for handicapped of a person displayed on the additional panel **H-07.1** may also be used on this sign.

Image of an example of G-21.1



G-21.2 notifies of a location of a pedestrian underpass without steps. The symbol of a person displayed on the additional panel H-07.1 may also be used on this sign.

Image of an example of G-21.2



40K. Signs notifying an exit from a motorway

EXIT FROM A MOTORWAY

~~Signs G, 22 a; G, 22 b and G, 22 c are examples of advance signs for notifying~~
G-22.1 notifies drivers of a distance to an exit from a motorway. It shall bear three oblique stripes sloping downwards towards the carriageway and it may bear a distance inscription. ~~These signs shall bear the indication of a distance to the exit from a motorway, as determined by domestic legislation.~~
It shall be set up provided that signs bearing respectively one and two oblique bars stripes are set up at one-third and two-thirds of the distance between ~~the this sign bearing three oblique bars stripes and the exit from a motorway.~~
~~These signs~~ **It shall have a blue or green ground; the oblique bars stripes and inscriptions shall be white.**

Image of an example of G-22.1



Reversed stripes



G-22.2 notifies drivers of the distance to an exit from a motorway. It shall bear two oblique stripes sloping downwards towards the carriageway and it may bear a distance inscription. It shall be set up at two-thirds of a given distance, provided that signs bearing respectively one and three oblique

stripes are also set up. It shall have a blue or green ground; the oblique stripes and inscriptions shall be white.

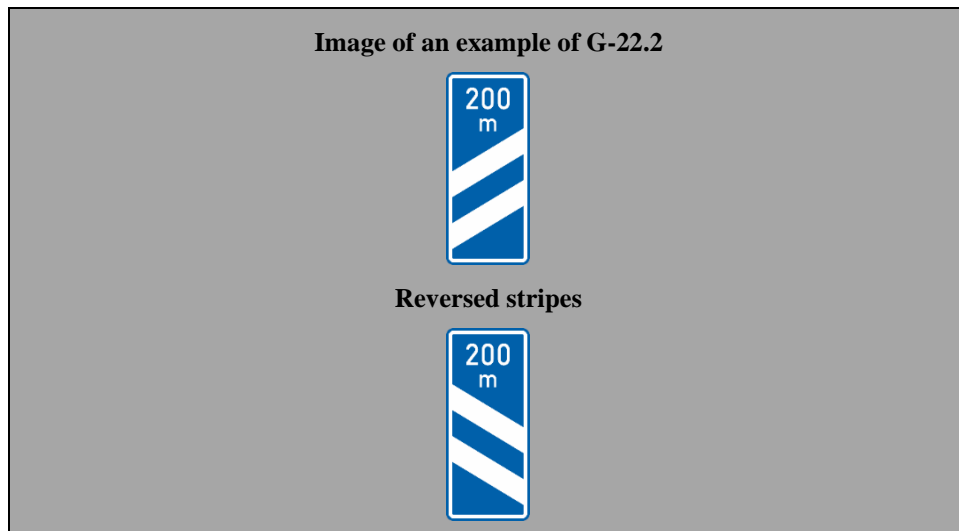

G-22.3 notifies drivers of a distance to an exit from a motorway. It shall bear one oblique stripe sloping downwards towards the carriageway and it may bear a distance inscription. It shall be set up at one-third of a given distance, provided that signs bearing respectively two and three oblique stripes are also set up. It shall have a blue or green ground; the oblique stripe and inscriptions shall be white.

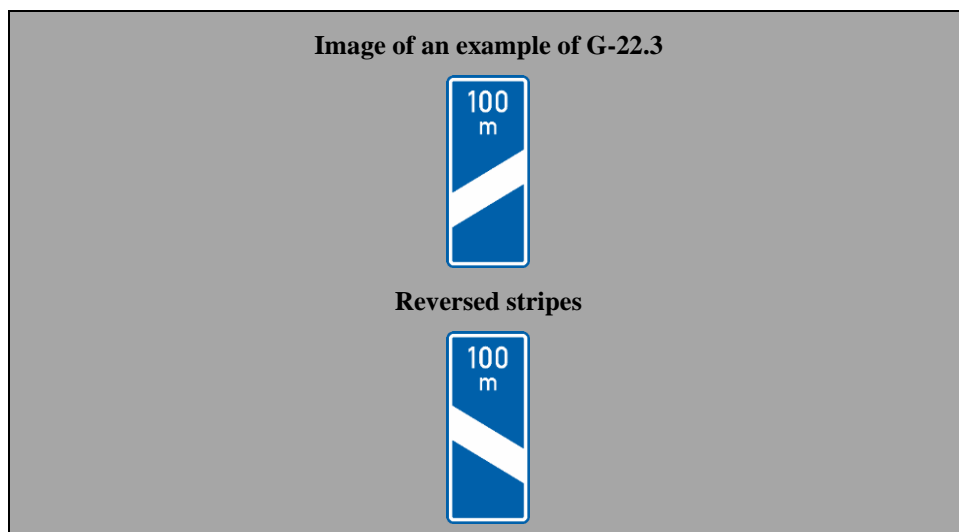

4L. Signs indicating emergency exits

EMERGENCY EXIT

(a) The signs G, 23 a and G, 23 b indicate the location of emergency exit. G-23.0 notifies of the location of emergency exit. The symbol on this sign may be reversed.

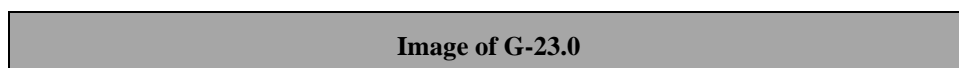

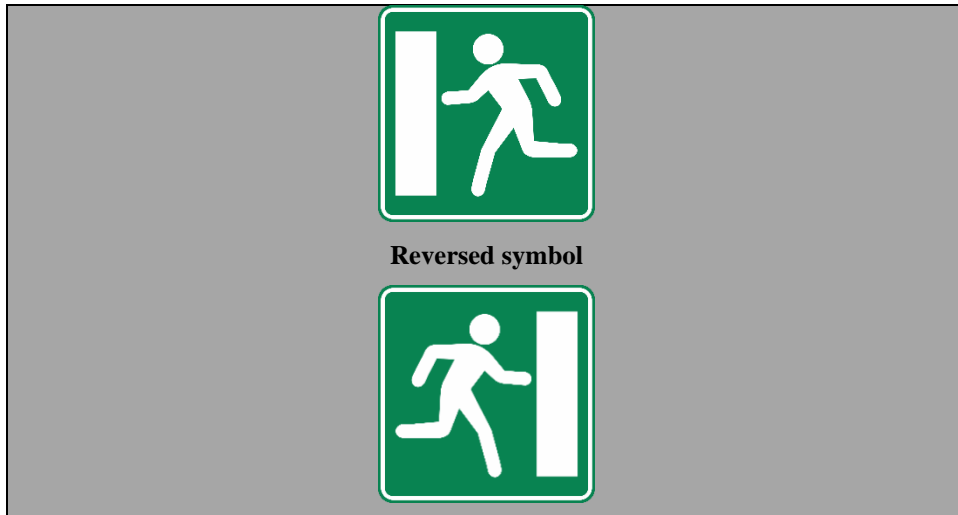

DIRECTION TO THE NEAREST EMERGENCY EXIT (LEFT)

(b) ~~The signs G, 24 a, G, 24b and G, 24c are examples of signs to indicate~~ **G-24.1** notifies of the direction and distance to the nearest emergency exits ~~to the left~~. In tunnels, they shall be placed at a maximum distance of 50 m apart and at a height of 1 to 1.5 m on the sidewalls.

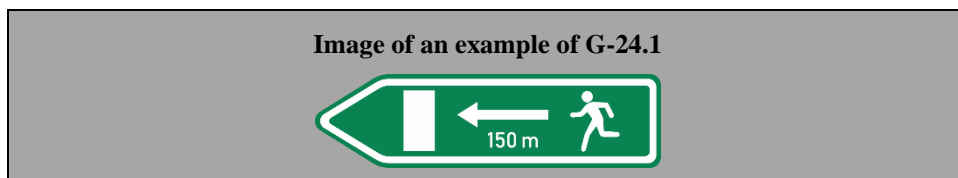

DIRECTION TO THE NEAREST EMERGENCY EXIT (RIGHT)

G-24.2 notifies of the direction and distance to the nearest emergency exit to the right. In tunnels, they shall be placed at a maximum distance of 50 m apart and at a height of 1 to 1.5 m on the sidewalls.

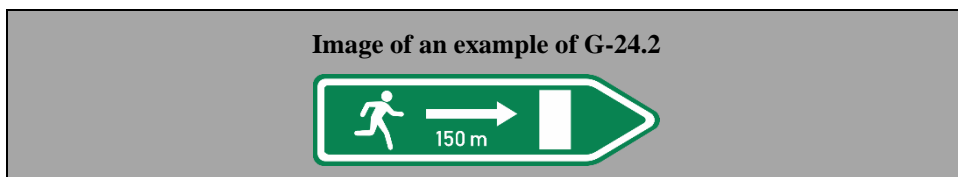

DIRECTIONS TO THE NEAREST EMERGENCY EXIT

G-24.3 notifies of the direction and distance to the nearest emergency exits to both the left and right. In tunnels, they shall be placed at a maximum distance of 50 m apart and at a height of 1 to 1.5 m on the sidewalls.



(c) ~~The signs G, 23 and G, 24~~ **All emergency exit signs shall** have a green ground and the symbols, arrows and distance indications ~~are~~ **shall be** white or of a light colour.

12M. Sign indicating crash through gates

CRASH THROUGH GATES

G-25.0 notifies drivers to crash through the level crossing gate when trapped between closed gates. This sign shall be placed on the inside of the second gate in the direction of traffic.

The sign shall have a green ground. The symbol of a vehicle shall be green and the “crash symbol” shall be white. The gate shown on the sign may be of colours applied by the State concerned in accordance with Article 35, paragraph 1 of this Convention.

This sign may be used with an additional panel bearing an inscription “if trapped, crash through gate” in the national language. Such a panel, if used, shall be placed on the gate next to the sign. The symbol on this sign may be reversed.

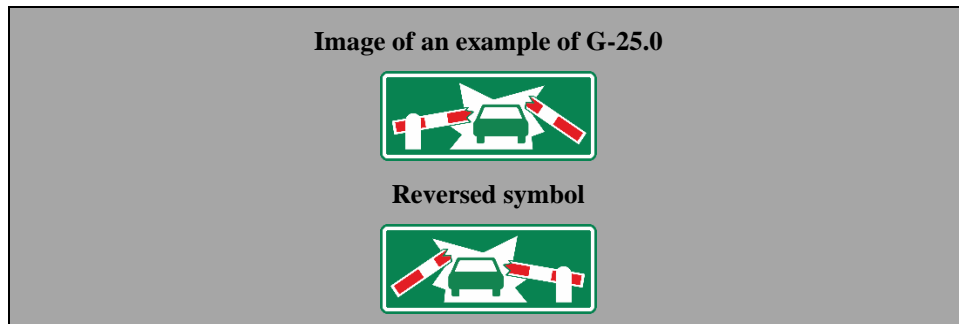

N. Signs indicating temporary conditions due to road works or detours

These signs shall have a yellow or orange ground; symbols and inscriptions shall be black. When rims at the edge are used, they shall be black.

These signs may bear the symbols used on other signs or display other signs notifying road users of the characteristics of the route or traffic conditions.

SCHEME OF DIVERSION

G-26.0 displays a diagram for a diversion. It may bear the name of a place to which the diversion applies or the inscription “Diversion” in the national language. The symbol on this sign may be reversed.

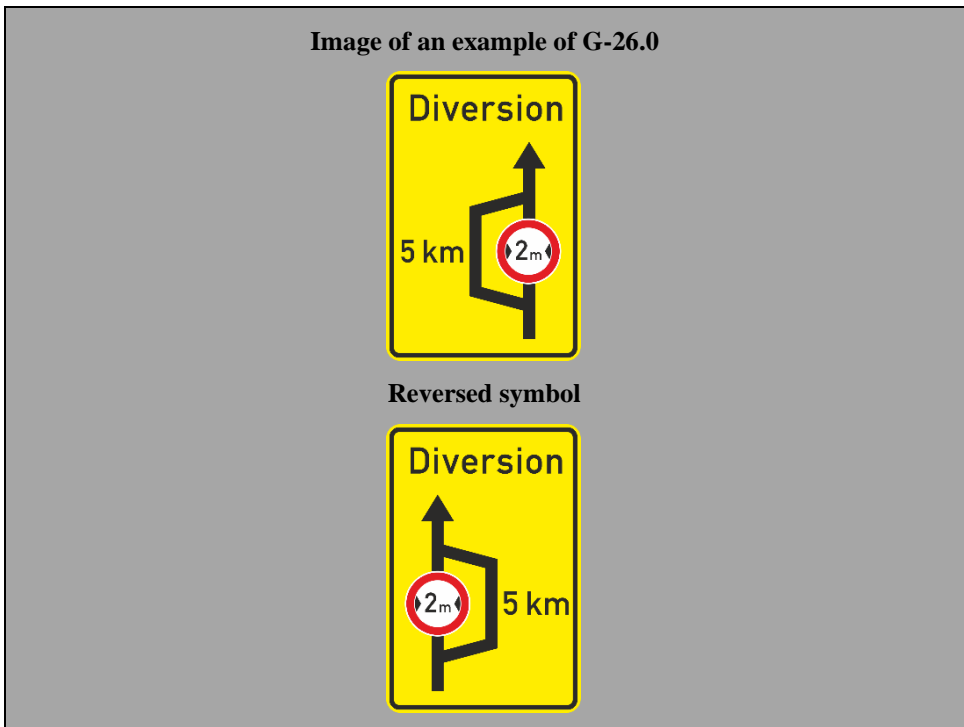

DIVERSION DIRECTION (LEFT)

G-26.1 notifies of the direction of a diversion to the left. The sign shall differ conspicuously from the direction sign G-05.1. The sign may bear the name of a place to which the diversion applies or the inscription “Diversion” in the national language.

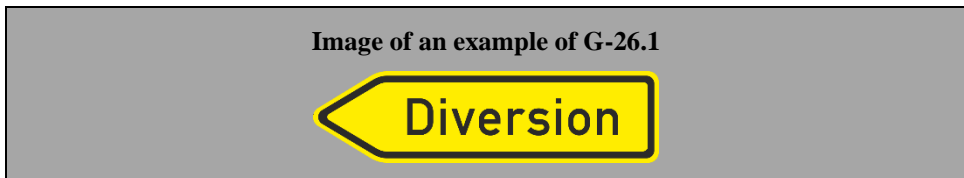

DIVERSION DIRECTION (RIGHT)

G-26.2 notifies of the direction of a diversion to the right. The sign shall differ conspicuously from the direction sign G-05.2. It may bear the name of a place to which the diversion applies or the inscription “Diversion” in the national language.

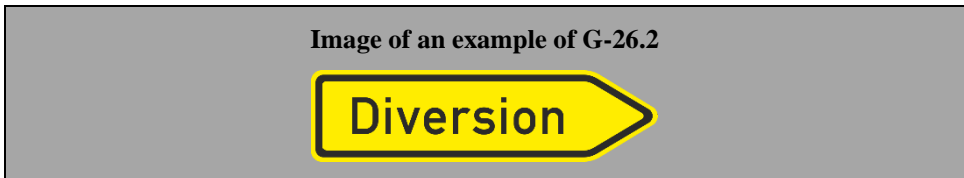

DIRECTION OF DIVERSION

G-26.3 notifies of the direction of a diversion. This sign is an example of a diversion direction sign showing the direction of the diversion with an arrow. The sign shall differ conspicuously from the direction sign G-05.3. It may bear the name of a place to which the diversion applies or the inscription “Diversion” in the national language.

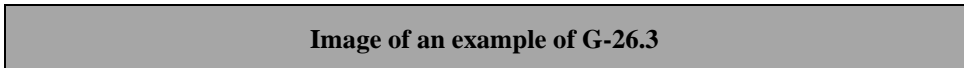



DIRECTION OF LANES DURING ROAD WORKS

G-27.0 notifies of the direction of lanes during road works. The sign shall display the same number of arrows as the number of lanes allocated to traffic in the same direction.

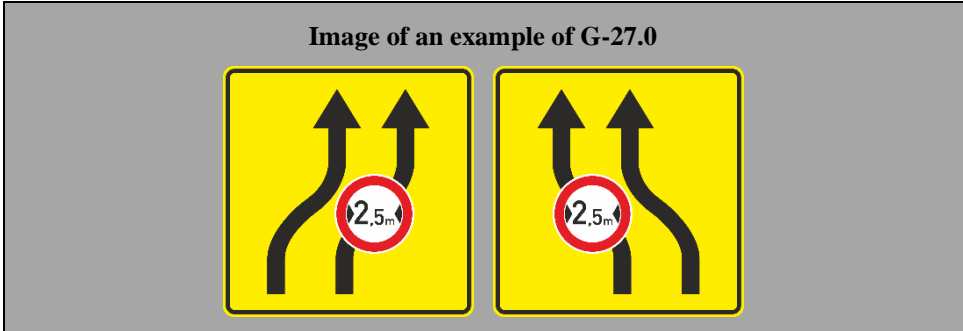

TEMPORARY LANE CLOSURE

G-28.0 notifies of a temporary closure of a lane. The sign shall display the same number of arrows as the number of lanes allocated to traffic in the same direction. Road markings may be included.

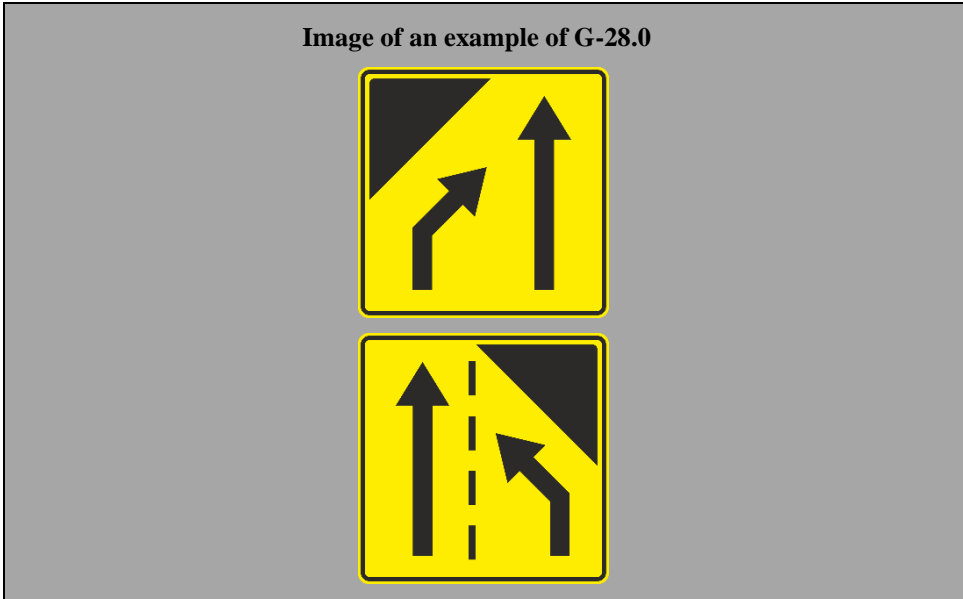

Section H

ADDITIONAL PANELS

I. General characteristics and symbols

1. — These panels shall have either a white or yellow ground and a black, dark blue or red rim, in which case the distance or length or symbol shall be inscribed in black or dark blue; or a black or dark blue ground and a white, yellow or red rim, in which case the distance or length or symbol shall be inscribed in white or yellow.

Additional panels, used with danger warning, priority, prohibitory and restrictive signs, shall have a white or yellow ground and a black or a dark blue symbol or inscription. Additional panels, used with mandatory, special regulations, and informative signs, shall have either a white or yellow ground and a black or a dark blue symbol or inscription; or they shall have a green or blue ground and a white symbol or inscription. Additional panels are always placed under the signs except the additional panel used with sign G-25.0.

II. Definitions and images

1. Additional panels indicating the distance to or a length of a section of road

DISTANCE PANEL

2. (a) ~~Additional panels H, 1 show~~ **H-01.0 notifies** of the distance from the sign to the beginning of the dangerous section of road or of the zone to which the regulation or information applies.

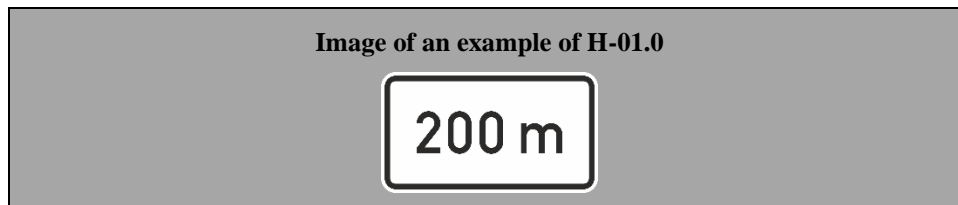

LENGTH INDICATION PANEL

(b) ~~Additional panels H, 2 show~~ **H-02.0 notifies** of the length of the dangerous section of road or of the zone to which the regulation applies.

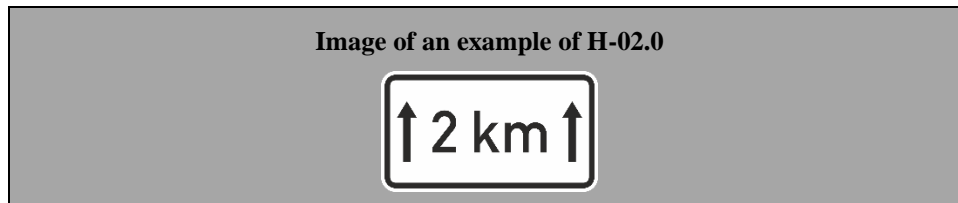

(c) ~~Additional panels are placed under the signs. However, The distance information given on the additional panels H-01.0 and H-02.0 may instead be inscribed on the lower part of the sign in the case of danger warning signs of model A~~b~~ two (square with one vertical diagonal), and elsewhere if permitted. the information to be given on the additional panels may be inscribed on the lower part of the sign.~~

2. Additional panels concerning parking, parking prohibition or restriction

3. ~~The additional panels H, 3 and H, 4 concerning parking prohibitions or restrictions are of models H, 3a; H, 3b and H, 3c and H, 4a; H, 4b and H, 4c respectively. (See: section C, para. 9 (c) of this annex). These additional panels used in conjunction with the sign E-12.1 show the direction to parking places. When used with signs notifying parking prohibition or restriction, they notify about the beginning, continuation or the end of the prohibition or restriction. The use of the additional panels concerning parking prohibition or restriction is detailed in section C, paragraph 10, Additional Provisions, applying to prohibition or restriction of standing and parking.~~

PANEL INDICATING THE BEGINNING OF PARKING, PARKING PROHIBITION OR RESTRICTION OR THE DIRECTION TO PARKING PLACES

H-03.1 notifies of the point from which the parking prohibition or restriction begins when used in conjunction with signs notifying parking prohibition or restriction. It notifies of parking places to the left from E-12.1 sign. This panel shall be placed parallel to the axis of the road.

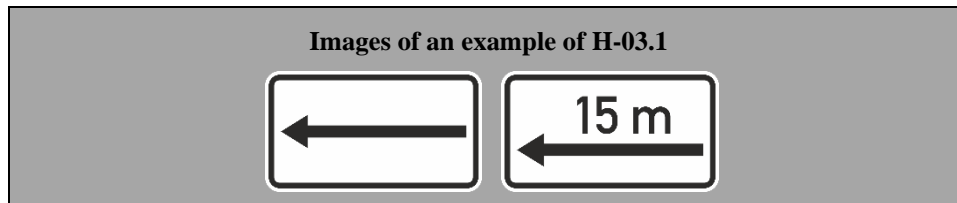

PANEL INDICATING THE REPETITION OF PARKING PROHIBITION OR RESTRICTION OR THE DIRECTION TO PARKING PLACES

H-03.2 notifies that the parking prohibition or restriction continues when used in conjunction with signs notifying parking prohibition or restriction. It notifies of parking places to the left and right from E-12.1 sign. This panel shall be placed parallel to the axis of the road.

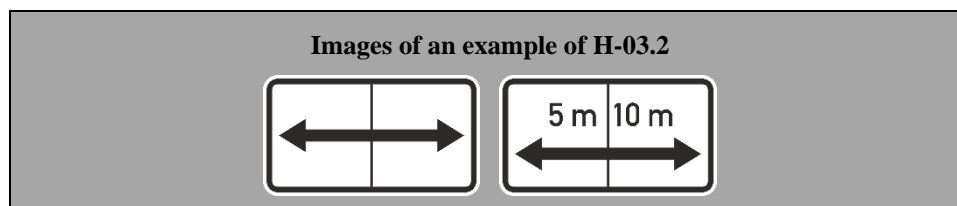

PANEL INDICATING THE END OF PARKING PROHIBITION OR RESTRICTION OR THE DIRECTION TO PARKING PLACES

H-03.3 notifies of the point at which the parking prohibition or restriction ends when used in conjunction with signs notifying parking prohibition or restriction. It notifies of parking places to the right from E-12.1 sign. This panel shall be placed parallel to the axis of the road.

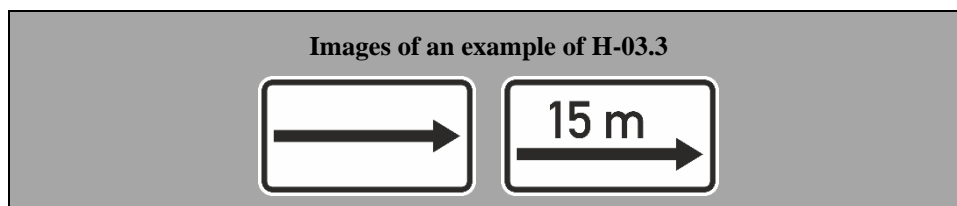

PANEL INDICATING THE BEGINNING OF PARKING PROHIBITION OR RESTRICTION OR THE DIRECTION TO PARKING PLACES

H-04.1 notifies of the point from which the parking prohibition or restriction begins when used in conjunction with signs notifying parking prohibition or restriction. It notifies of parking places onward from the E-12.1 sign. This panel shall be placed perpendicular to the axis of the road.

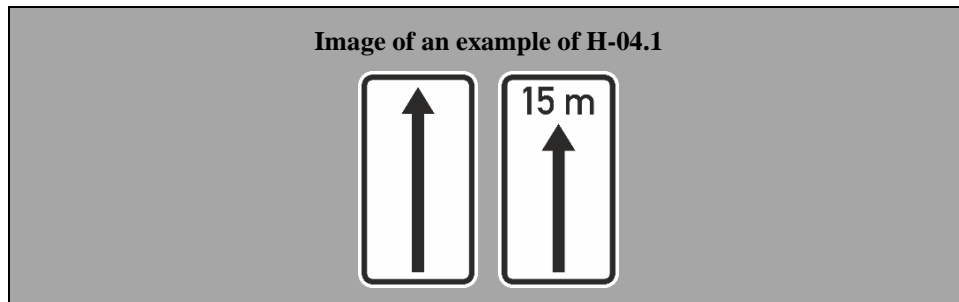

PANEL INDICATING THE REPETITION OF PARKING PROHIBITION OR RESTRICTION OR THE DIRECTION TO PARKING PLACES

H-04.2 notifies that the parking prohibition or restriction continues when used in conjunction with signs notifying parking prohibition or restriction. It notifies of parking places onward and backward from the E-12.1 sign. This panel shall be placed perpendicular to the axis of the road.

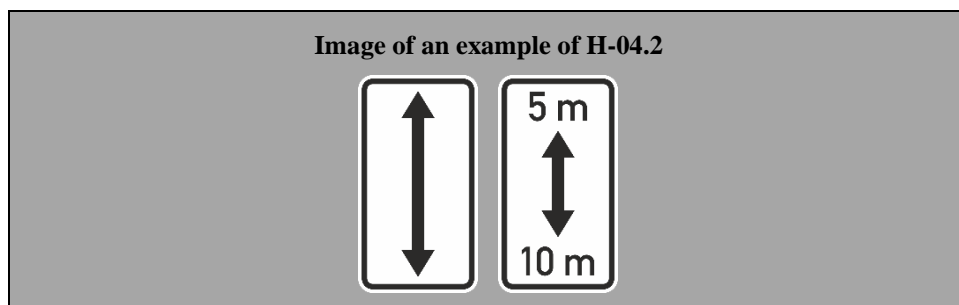

PANEL INDICATING THE END OF PARKING PROHIBITION OR RESTRICTION OR THE DIRECTION TO PARKING PLACES

H-04.3 notifies of the point at which the parking prohibition or restriction ends when used in conjunction with signs notifying parking prohibition or restriction. It notifies of parking places backward from the E-12.1 sign. This panel shall be placed perpendicular to the axis of the road.

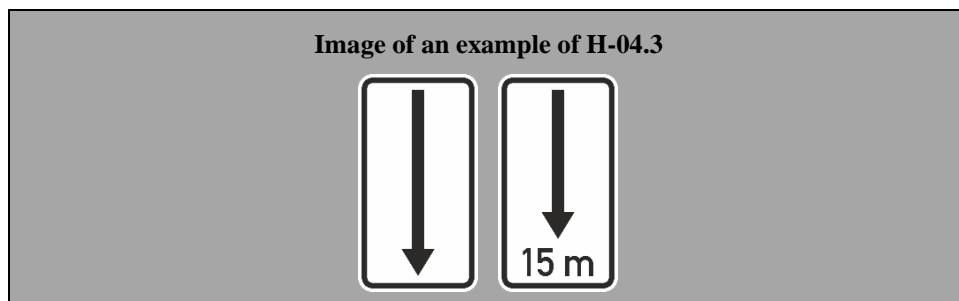

3. Additional panels displaying symbols of road users

ROAD USER PANEL

4. Regulatory signs may be restricted to particular road users by displaying the symbol for their category. For example: H, 5a, and H, 5. H-05.0 displays the symbol of a particular road user category to whom the regulatory sign applies. All symbols from signs C-03.1 to C-03.14, and E-13.1, E-13.2, and

F-07.3 may be used on additional panel H-05.0. If necessary, the symbol may be replaced by an inscription in the national language of the State concerned.

Image of an example of H-05.0



H-06.0 displays the symbol of a particular road user category to whom the regulatory sign does not apply. In cases where the regulatory sign is to be regarded as not applying to a certain category of road users this is indicated by the symbol for their category and by the term "except" in the language of the particular country. For example: H, 6. If necessary the symbol may be replaced by an inscription in that language. This additional panel shall be identical to additional panel H-05.0 except that it shall display, in addition, the inscription "except" in the national language of the State concerned. If necessary, the symbol may be replaced by an inscription in the national language of the State concerned.

Image of an example of H-06.0

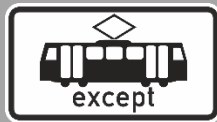

4. Additional panel indicating persons with disabilities

PERSON WITH DISABILITIES PANEL

5. — To indicate ~~H-07.1 indicates, when used in conjunction with E-12.1, that parking space is reserved for handicapped persons with disabilities.~~ panel H, 7 should be used with signs C, 18 or E, 14.

Image of H-07.1



H-07.2 indicates, when used in conjunction with C-18.0, that parking is not prohibited for persons with disabilities. This additional panel shall be identical to additional panel H-07.1 except that it shall display, in addition, the inscription "except" in the national language of the State concerned.

Image of H-07.2



5. Additional panels for use at intersections

INTERSECTION PANEL

~~6. The additional panel H, 8~~ **H-08.0** displays a diagram of the intersection in which broad strokes indicate priority roads and thin strokes indicate the roads on which signs ~~B, 1 or B, 2~~ **B-01.0 or B-02.0** are set up.

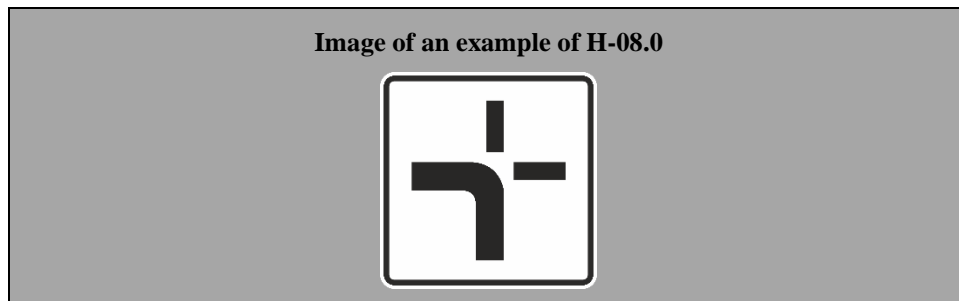

6. Additional panel to indicate ice or snow

ICE OR SNOW PANEL

~~7. To indicate~~ **H-09.0 indicates** that the section of road ahead is slippery because of ice or snow ~~the additional panel H, 9 should be used. This panel may only be used with A-09.0 or A-29.0 signs.~~

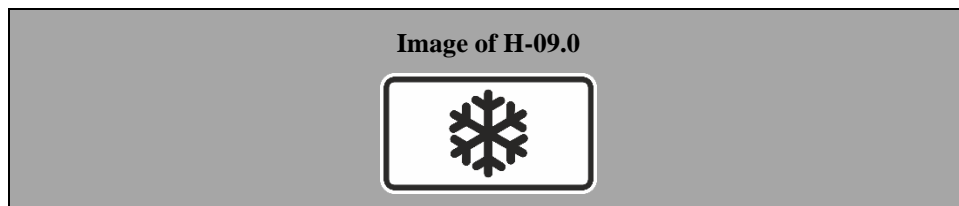

~~NOTE APPROPRIATE TO THE WHOLE OF ANNEX I: In countries where traffic keeps to the left, signs and/or symbols shall be reversed as appropriate.~~

7. Additional panel to indicate distance to a STOP sign

DISTANCE TO A STOP SIGN

H-10.0 indicates the distance to a STOP sign. It shall be used in accordance with section B, paragraph 2 of this Annex.

Image of an example of H-10.0



Annex 2

ROAD MARKINGS

Chapter I

GENERAL

1. Road surface markings (road markings) should be of non-skid materials and should not protrude more than 6 mm above the level of the carriageway. Studs or similar devices used for marking should not protrude more than 1.5 cm above the level of the carriageway (or more than 2.5 cm in the case of studs incorporating reflex reflectors); they should be used in accordance with road traffic safety requirements.

Chapter II

LONGITUDINAL MARKINGS

A. DIMENSIONS

2. The width of continuous or broken lines used for longitudinal markings should be at least 0.10 m.
3. The distance between two adjacent longitudinal lines (double line) should be between 0.10 m and 0.18 m.
4. A broken line shall consist of strokes of equal length separated by uniform gaps. The speed of vehicles on the section of road or in the area in question should be taken into account in determining the length of the strokes and of the gaps between them.
5. Outside built-up areas a broken line should consist of strokes between 2 m and 10 m long. The length of the strokes forming the approach line referred to in paragraph 23 of this Annex should be from two to three times the length of the gaps.
6. In built-up areas, the length and spacing of the strokes should be less than they are outside built-up areas. The strokes may be reduced to 1 m. On certain main urban arteries where traffic moves fast, however, the characteristics of longitudinal markings may be the same as outside built-up areas.

B. TRAFFIC LANE MARKINGS

7. Traffic lanes shall be marked by broken lines, by continuous lines or by other appropriate means.
 - (i) Outside built-up areas
8. On two-way roads having two lanes, the centre line of the carriageway should be indicated by a longitudinal marking. This marking shall normally consist of a broken line. Continuous lines should only be used for this purpose in special circumstances.
9. On three-lane roads, the lanes should, as a general rule, be indicated by broken lines along sections where visibility is normal. In specific cases and in order to ensure greater traffic safety, continuous lines or broken lines adjacent to continuous lines may be used.
10. On carriageways having more than three traffic lanes, the two directions of traffic should be separated by one continuous line or by two continuous lines, except in cases where the direction of traffic in the central lanes can be reversed. In addition, the traffic lanes should be marked by broken lines (diagrams 1a and 1b).

(ii) In built-up areas

11. In built-up areas, the recommendations contained in paragraphs 8 to 10 of this Annex are applicable to two-way streets and to one-way streets with at least two traffic lanes.

12. Traffic lanes should be marked at points where the width of the roadway is reduced by kerbs, islands or directional islands.

13. At the approaches to major intersections (especially intersections where traffic is controlled), where the width is sufficient for two or more lines of vehicles, traffic lanes should be marked as shown in diagrams 2 and 3. In such cases, the lines marking the lanes may be supplemented with arrow markings (see para. 39 of this Annex).

C. Markings for particular situations

(i) Use of continuous lines

14. In order to improve traffic safety, the broken centre lines at certain intersections (diagram 4) should be replaced or supplemented by a continuous line (diagrams 5 and 6).

15. When it is necessary to prohibit the use of the part of the carriageway reserved for oncoming traffic at places where the range of vision is restricted (hill crest, bend in the road, etc.) or on sections where the carriageway is narrow or has some other peculiarity, restrictions should be imposed on sections where the range of vision is less than a certain minimum M , by means of a continuous line laid out in accordance with diagrams 7a to 16¹. In countries where the design of motor vehicles justifies it, the eye level of 1 m indicated in diagrams 7a to 10a may be raised to 1.20 m.

16. The value to be adopted for M varies with road conditions. Diagrams 7a, 7b, 8a, 8b, 8c and 8d show, for two- and three-lane roads respectively, the design of the lines at a hill crest with a restricted range of vision. These diagrams correspond to the longitudinal section at the top of the same page and to a distance M specified in paragraph 24 below: A (or D) is the point where the range of vision becomes less than M , while C (or B) is the point where the range of vision again begins to exceed M^2 .

17. Where the sections AB and CD overlap, i.e. when forward visibility in both directions becomes greater than M before the crest of the hill is reached, the lines should be arranged in the same way, but the continuous lines alongside a broken line should not overlap. This is indicated in diagrams 9, 10a and 10b.

18. Diagrams 11a and 11b show the position of the lines for the same case on a curve with restricted range of vision on a two-lane road.

19. On three-lane roads two methods are possible. These are shown in diagrams 8a, 8b, 8c and 8d (or 10a and 10b). Diagram 8a (or 8b or 10a) should be used on roads carrying a substantial proportion of two-wheeled vehicles and diagrams 8c and 8d (or 10b) where the traffic consists mainly of four-wheeled

¹ The definition of range of vision used in this paragraph is the distance at which an object 1 metre (3 ft. 4 in.) above the surface of the carriageway can be seen by an observer on the road whose eye is also 1 metre (3 ft. 4 in.) above the carriageway.

² The marking between A and D shown in diagrams 7a and 7b may be replaced by a single continuous centre line, without a broken line alongside, preceded by a broken centre line consisting of at least three strokes. Nevertheless, this simplified arrangement should be used with caution and only in exceptional cases, since it prevents the driver from overtaking for a certain distance even though the range of vision is adequate. It is desirable to avoid using both methods on the same route or on the same type of route in the same area, as this may lead to confusion.

vehicles. Diagram 11c shows the arrangement of the lines for the same case on a curve with restricted range of vision on a three-lane road.

20. Diagrams 12, 13 and 14 show the lines which indicate narrowing of the carriageway.

21. In diagrams 8a, 8b, 8c, 8d, 10a and 10b, the inclination of the oblique transition lines to the centre line should not exceed $1/20$.

22. In diagrams 13 and 14 which show the lines used to indicate a change in width of the available carriageway, as well as in diagrams 15, 16 and 17 which show obstacles necessitating a deviation from the continuous line (s), the inclination of the line (s) should preferably be less than $1/50$ on fast roads and less than $1/20$ on roads where speeds do not exceed 50 km/h (30 m.p.h.). In addition, the oblique continuous lines should be preceded, in the direction to which they apply, by a continuous line parallel to the centre line of the roadway, the length of the continuous line being the distance covered in one second at the driving speed adopted.

23. When it is not necessary to mark the traffic lanes by broken lines on a normal section of road, the continuous line should be preceded by an approach line consisting of a broken line, for a distance of at least 50 m, depending on the normal speed of the vehicles using the road. Where the traffic lanes are marked by broken lines on a normal section of road, the continuous line should also be preceded by an approach line for a distance of at least 50 m, depending on the normal speed of the vehicles using the road. The marking may be supplemented by one or more arrows showing drivers which lane they should take.

(ii) Conditions for the use of continuous lines

24. The choice of range of vision to be used in determining the sections on which a continuous line is or is not desirable, and the choice of the length of the line, is bound to be a compromise. The following table gives the recommended value of M for various approach speeds: ³

Approach speed	Range of values of M
100 km/h (60 m.p.h.)	160 m to 320 m
80 km/h (50 m.p.h.)	130 m to 260 m
65 km/h (40 m.p.h.)	90 m to 180 m
50 km/h (30 m.p.h.)	60 m to 120 m

25. For speeds not given in the preceding table the value of M should be calculated by interpolation or extrapolation.

D. Border lines indicating the limits of the carriageway

26. The limits of the carriageway shall preferably be marked by continuous lines. Studs, buttons or reflex reflectors may be used in conjunction with these lines.

E. Marking of obstructions

27. Diagrams 15, 16 and 17 show the markings to be used near an island or any other obstruction on the carriageway.

F. Guidelines for turning vehicles

28. At certain intersections it is desirable to show drivers how to turn left, in countries with right-hand traffic, or how to turn right in countries with left-hand traffic.

1. Road markings for a lane reserved for certain categories of vehicle

³ The approach speed used in this calculation is the speed which 85 per cent of the vehicles do not exceed, or the design speed if it is higher.

28 ~~bis~~. The marking of lanes reserved for certain categories of vehicle shall be by means of lines which should be clearly distinguished from other continuous or broken lines of the carriageway, notably by being wider and with less space between strokes. With respect to a lane reserved primarily for buses, the word "BUS" or the letter "A" shall be marked on the reserved lane wherever necessary and specifically at the beginning of the lane and after intersections. Diagrams 28a and 28b show examples of markings for a lane reserved for regular public transport service vehicles.

Chapter III

TRANSVERSE MARKINGS

A. GENERAL

29. Because of the angle at which the driver sees markings on the carriageway, transverse markings shall be wider than longitudinal markings.

B. STOP LINES

30. The minimum width of a stop line shall be 0.20 m and the maximum 0.60 m. A width of 0.30 m is recommended.

31. When used in conjunction with a STOP sign, the stop line should be placed in such a position that a driver who stops immediately behind the line has the clearest possible view of the traffic on the other arms of the intersection consistent with the requirements of other vehicular and pedestrian traffic.

32. Stop lines may be supplemented by longitudinal lines (diagrams 18 and 19). They may also be supplemented by the ~~word~~ "STOP" **inscription inscribed** on the carriageway as shown in the examples given in diagrams 20 and 21. The distance between the top of the letters of the ~~word~~ "STOP" **inscription** and the stop line should be between 2 m and 25 m.

C. LINES INDICATING POINTS AT WHICH DRIVERS MUST GIVE WAY

33. The minimum width of these lines should be 0.20 m and the maximum width 0.60 m; if there are two lines, the distance between them should be at least 0.30 m. The line may be replaced by triangles marked side by side on the ground with their vertices pointing towards the driver who is required to give way. The bases of these triangles should measure at least 0.40 m but not more than 0.60 m and their height should be at least 0.60 m but not more than 0.70 m.

34. Transverse marking (s) should be placed in the same positions as the stop lines referred to in paragraph 31 of this Annex.

35. The marking (s) referred to in paragraph 34 above may be supplemented by a triangle drawn on the carriageway as shown in the example given in diagram 22. The distance between the base of the triangle and the transverse marking should be between 2 m and 25 m. The base of the triangle shall be at least 1 m; its height shall be three times its base.

36. This transverse marking may be supplemented by longitudinal lines.

D. PEDESTRIAN CROSSINGS

37. The space between the stripes marking a pedestrian crossing should be at least equal to the width of the stripes and not more than twice that width: the width of a space and a stripe together should be between 1 m and 1.40 m. The minimum width recommended for pedestrian crossings is 2.5 m on roads on which the speed limit is 60 km/h, and 4 m on roads in which the speed limit is higher or there is no speed limit.

E. CYCLIST CROSSINGS

38. Cyclist crossings should be indicated by two broken lines. The broken line should preferably be made up of squares (0.40-0.60) x (0.40-0.60) m. The distance between the squares should be 0.40-0.60 m. The width of the crossings should be not less than 1.80 m. Studs and buttons are not recommended.

Chapter IV

OTHER MARKINGS

A. ARROW MARKINGS

39. On roads having sufficient traffic lanes to separate vehicles approaching an intersection, the lanes which traffic should use may be indicated by arrow markings on the surface of the carriageway (diagrams 2, 3, 19 and 23). Arrows may also be used on a one-way road to confirm the direction of traffic. The arrow should not be less than 2 m long. They may be supplemented by word markings on the carriageway.

B. OBLIQUE PARALLEL LINES

40. Diagrams 24 and 25 give examples of areas which vehicles should not enter.

C. WORD MARKINGS

41. Word markings on the carriageway may be used for the purpose of regulating traffic or warning or guiding road users. The words used should preferably be either place names, highway numbers or words which are easily understandable internationally (e.g. "Stop", "Bus", "Taxi").

42. The letters should be considerably elongated in the direction of traffic movement because of the small angle at which they are seen by approaching drivers (diagram 20).

43. Where approach speeds exceed 50 km/h (30 m.p.h.), the letters should be at least 2.5 m in height.

D. STANDING AND PARKING REGULATIONS

44. Standing and parking restrictions may be indicated by markings on the kerbs or on the carriageway. Parking space limits may be indicated on the surface of the carriageway by appropriate lines.

E. MARKINGS ON THE CARRIAGEWAY AND ON ADJACENT STRUCTURES

(i) Markings indicating parking restrictions

45. Diagram 26 gives an example of a zigzag line.

(ii) Marking of obstructions

46. Diagram 27 gives an example of a marking on an obstacle.

Diagram 1 a
Diagramme 1 a
Диаграмма 1 а

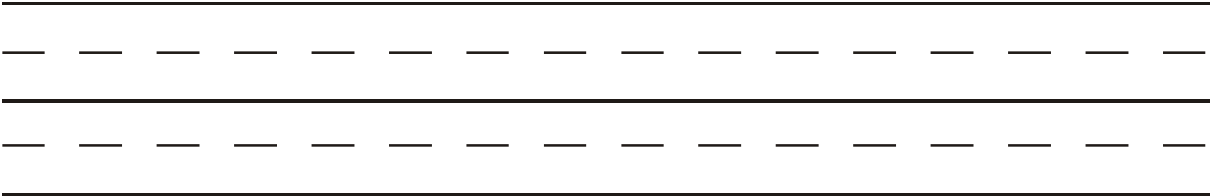
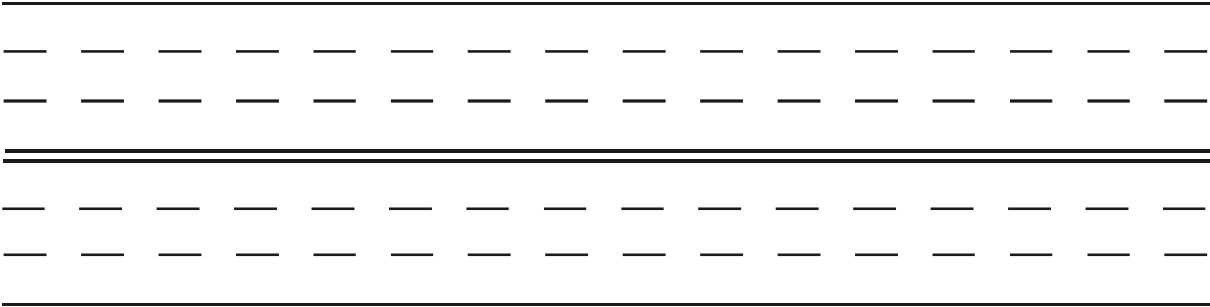

Diagram 1 b
Diagramme 1 b
Диаграмма 1 b



DIAGRAMS OF ANNEX 2
Diagram 2
Diagramme 2
Диаграмма 2

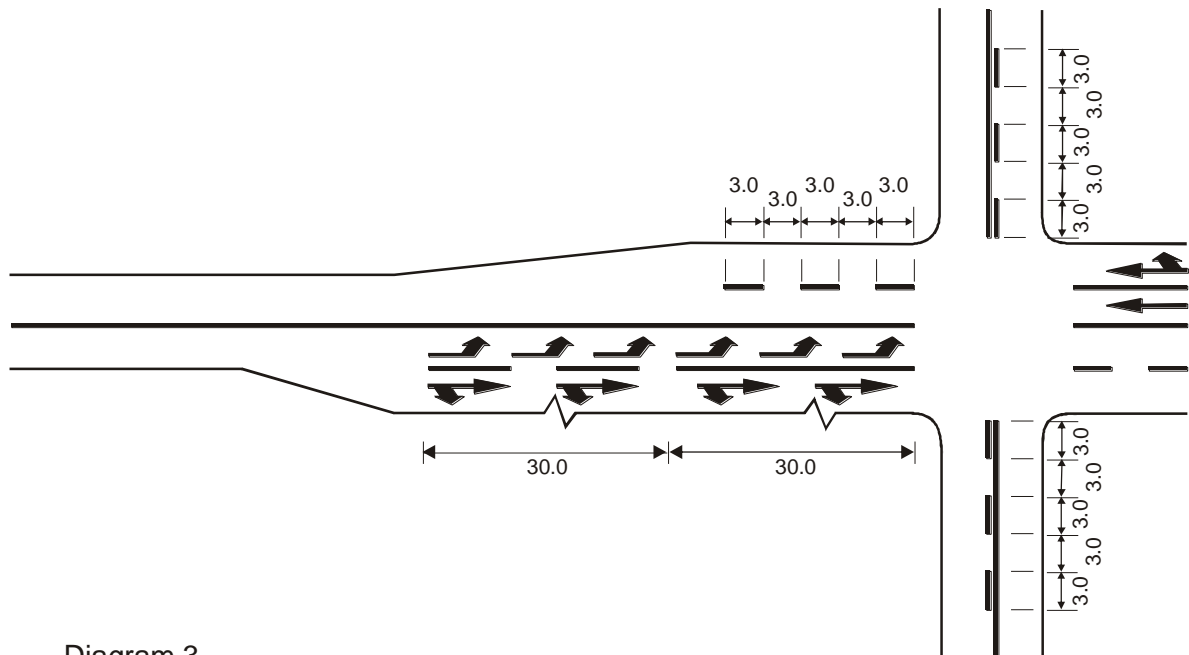

Diagram 3
Diagramme 3
Диаграмма 3

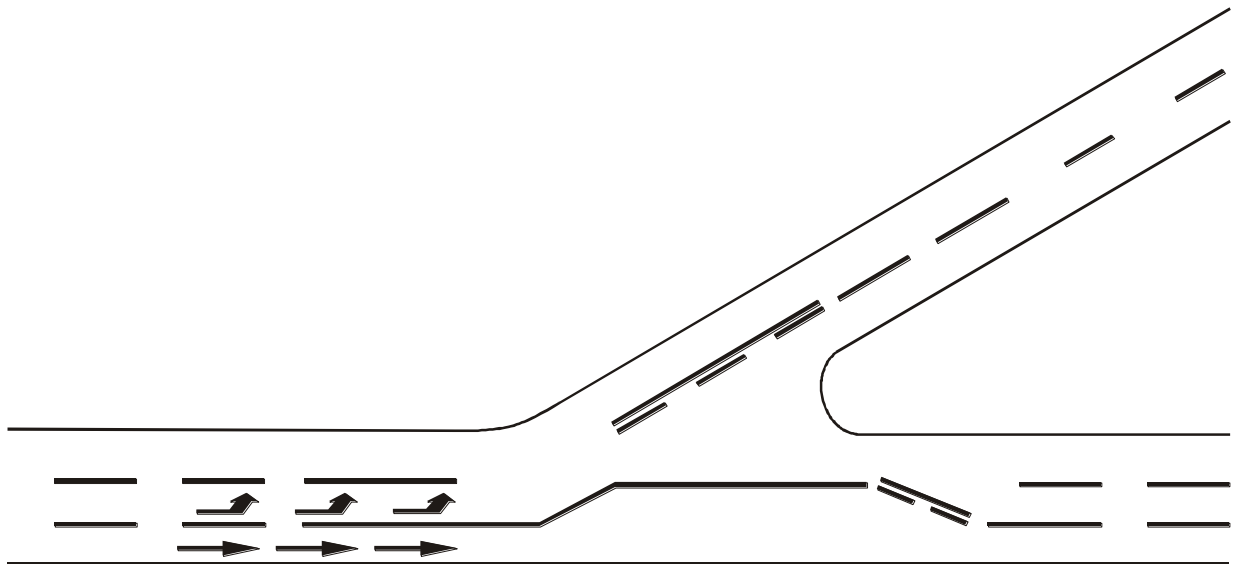

Diagram 4
Diagramme 4
Диаграмма 4

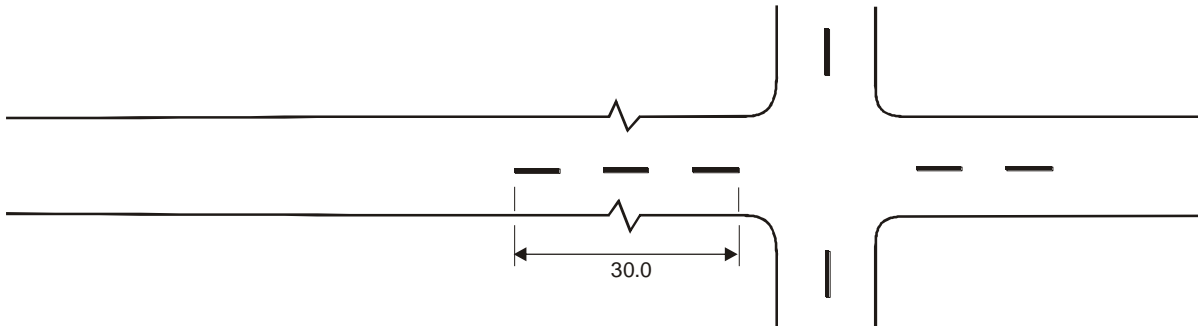

Diagram 5
Diagramme 5
Диаграмма 5

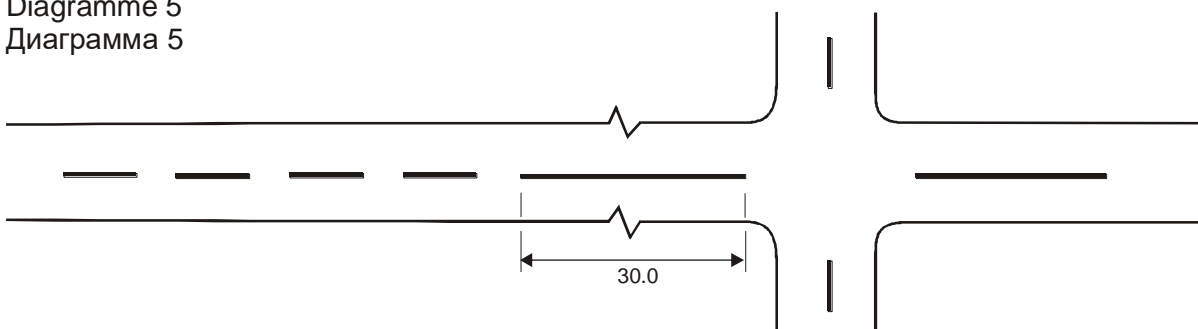

Diagram 6
Diagramme 6
Диаграмма 6

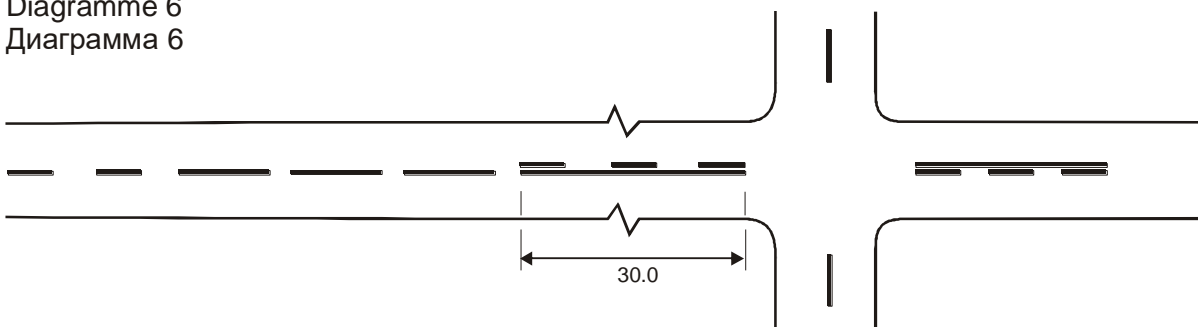
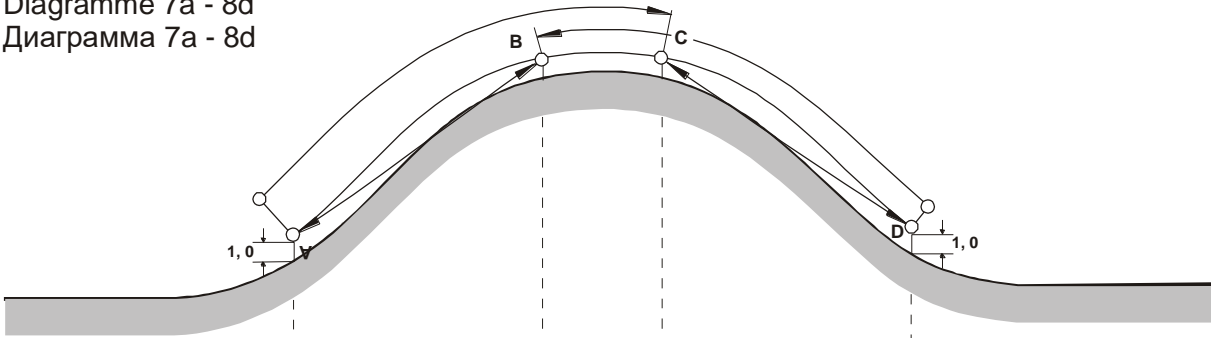
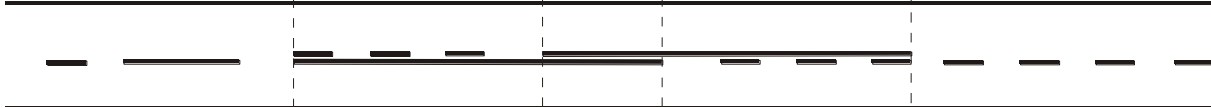

Diagram 7a - 8d
Diagramme 7a - 8d
Диаграмма 7a - 8d



(7a)



(7b)



(8a)



(8b)



(8c)



(8d)

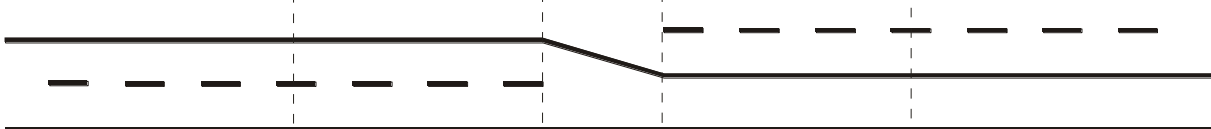

Diagram 9 - 10b
Diagramme 9 - 10b
Диаграмма 9 - 10b

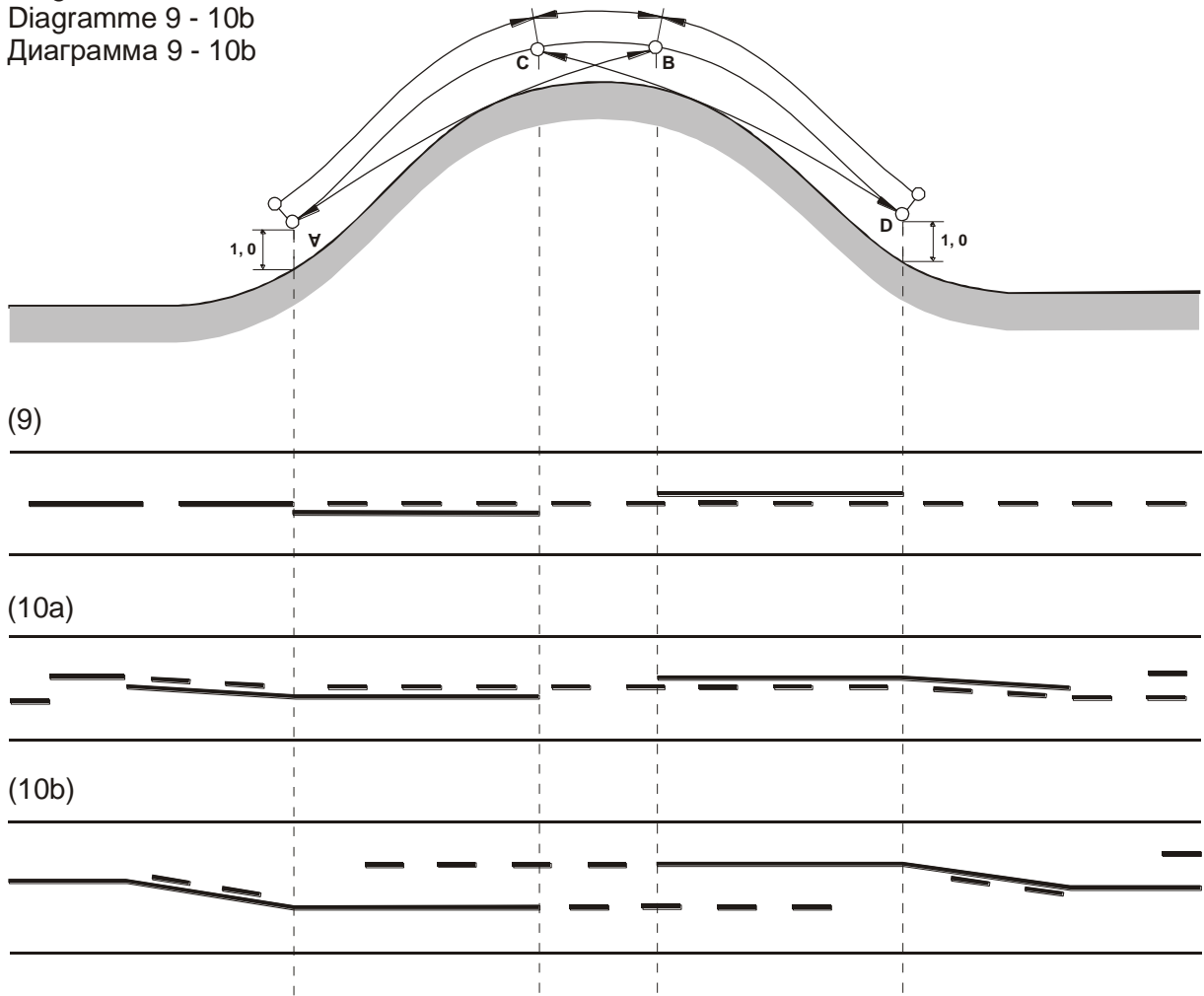
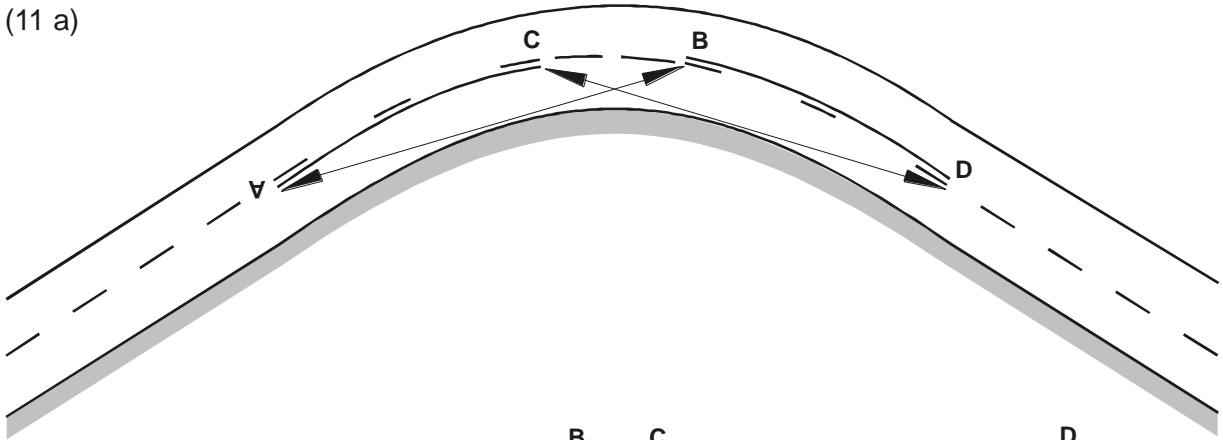
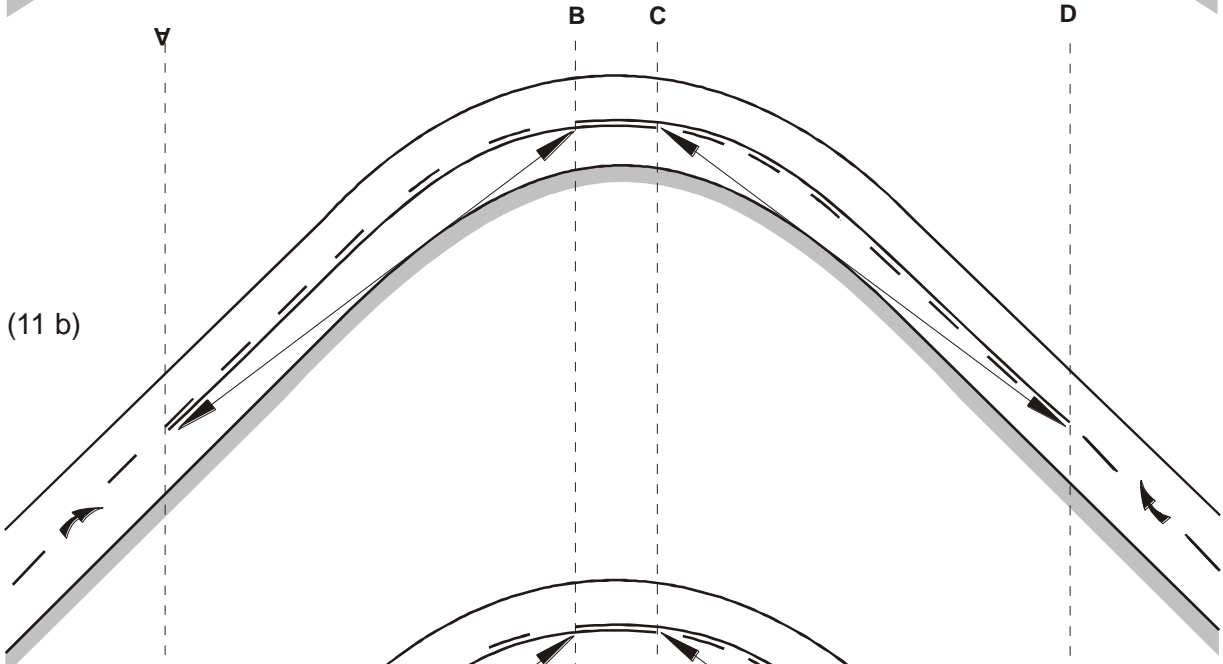

Diagram 11a - 11c
Diagramme 11a - 11c
Диаграмма 11a - 11c

(11 a)



(11 b)



(11 c)

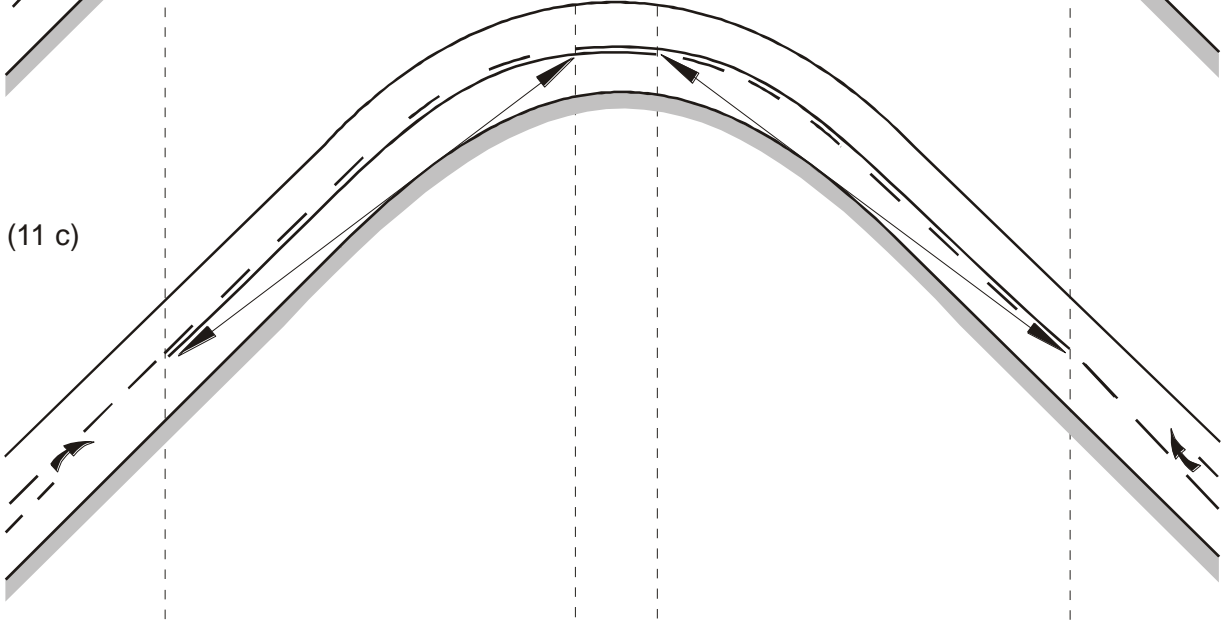
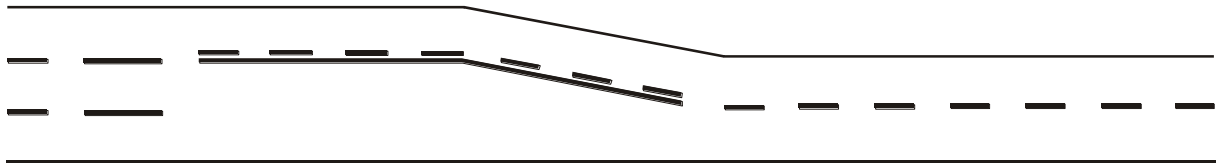
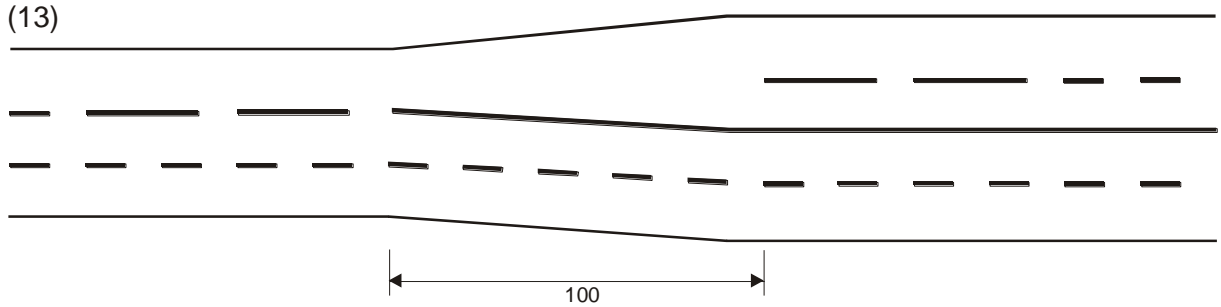

Diagram 12 - 15
Diagramme 12 - 15
Диаграмма 12 - 15

(12)



(13)



(14)

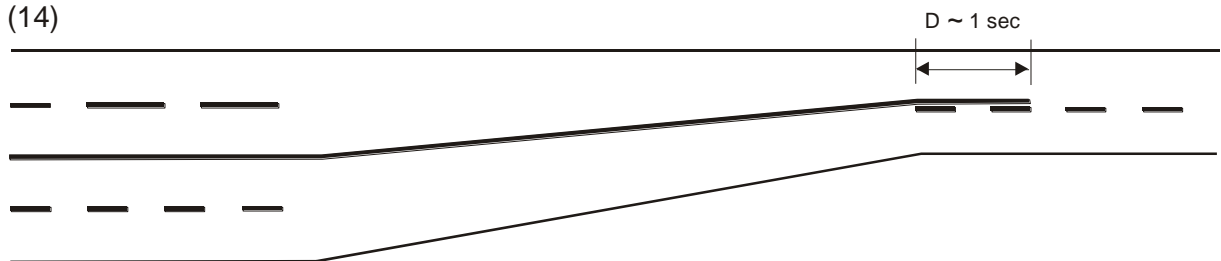

(15)

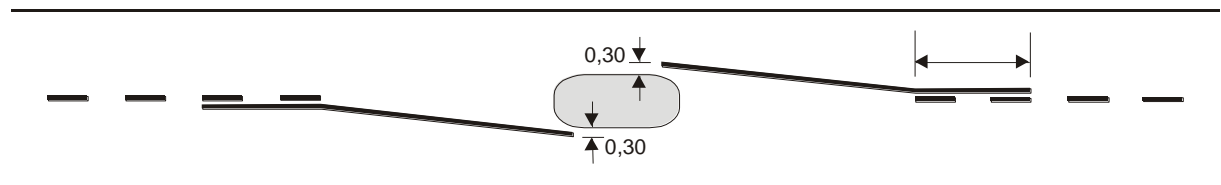
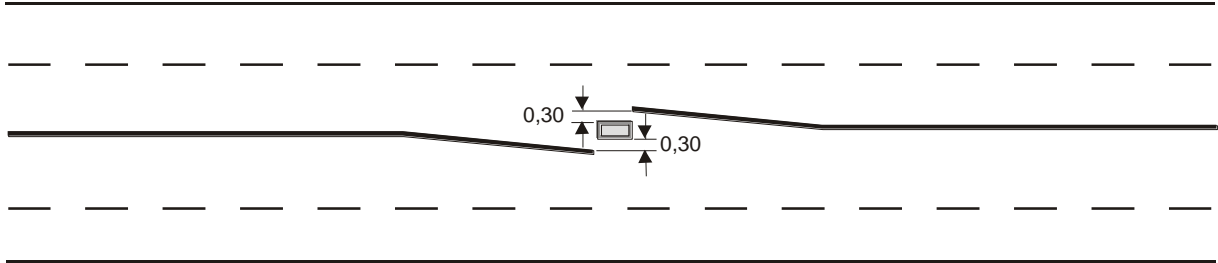
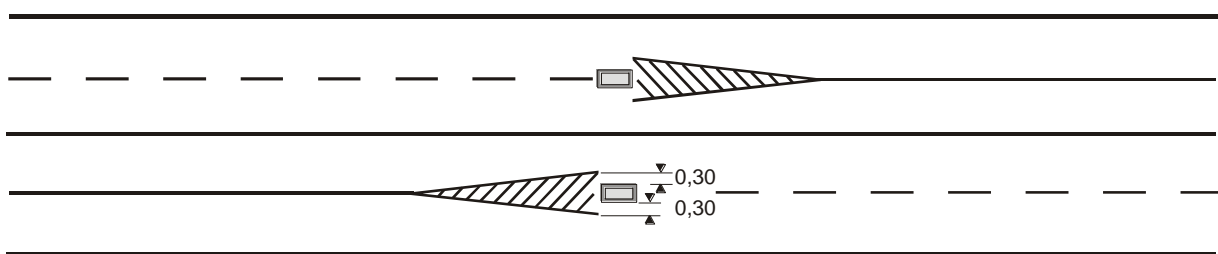

Diagram 16 - 18
Diagramme 16 - 18
Диаграмма 16 - 18

(16)



(17)



(18)

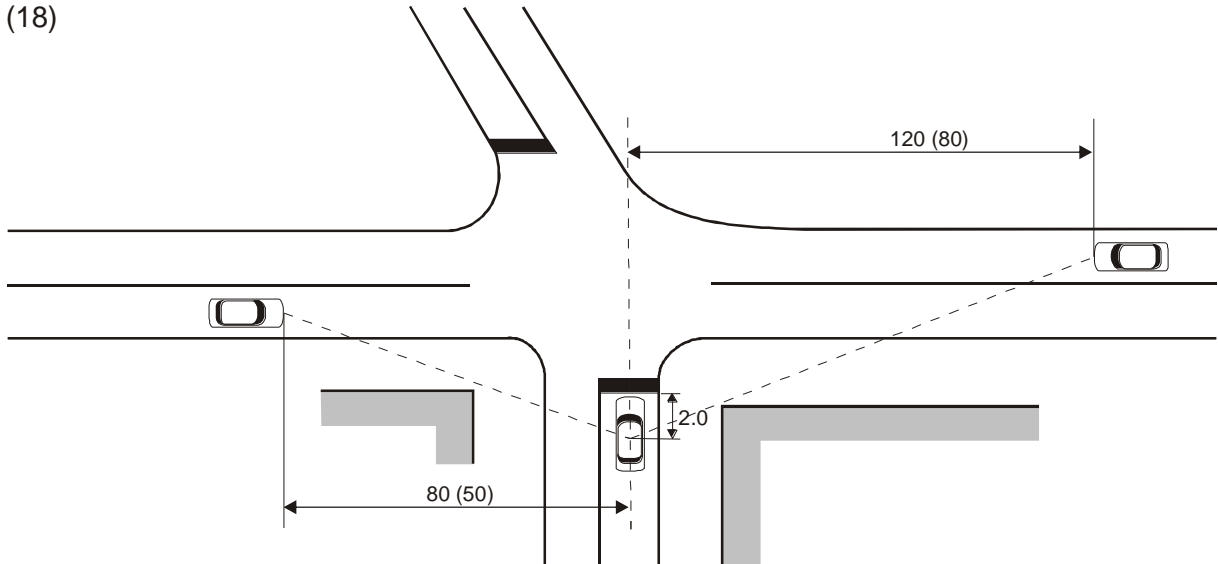

Diagram 19
Diagramme 19
Диаграмма 19

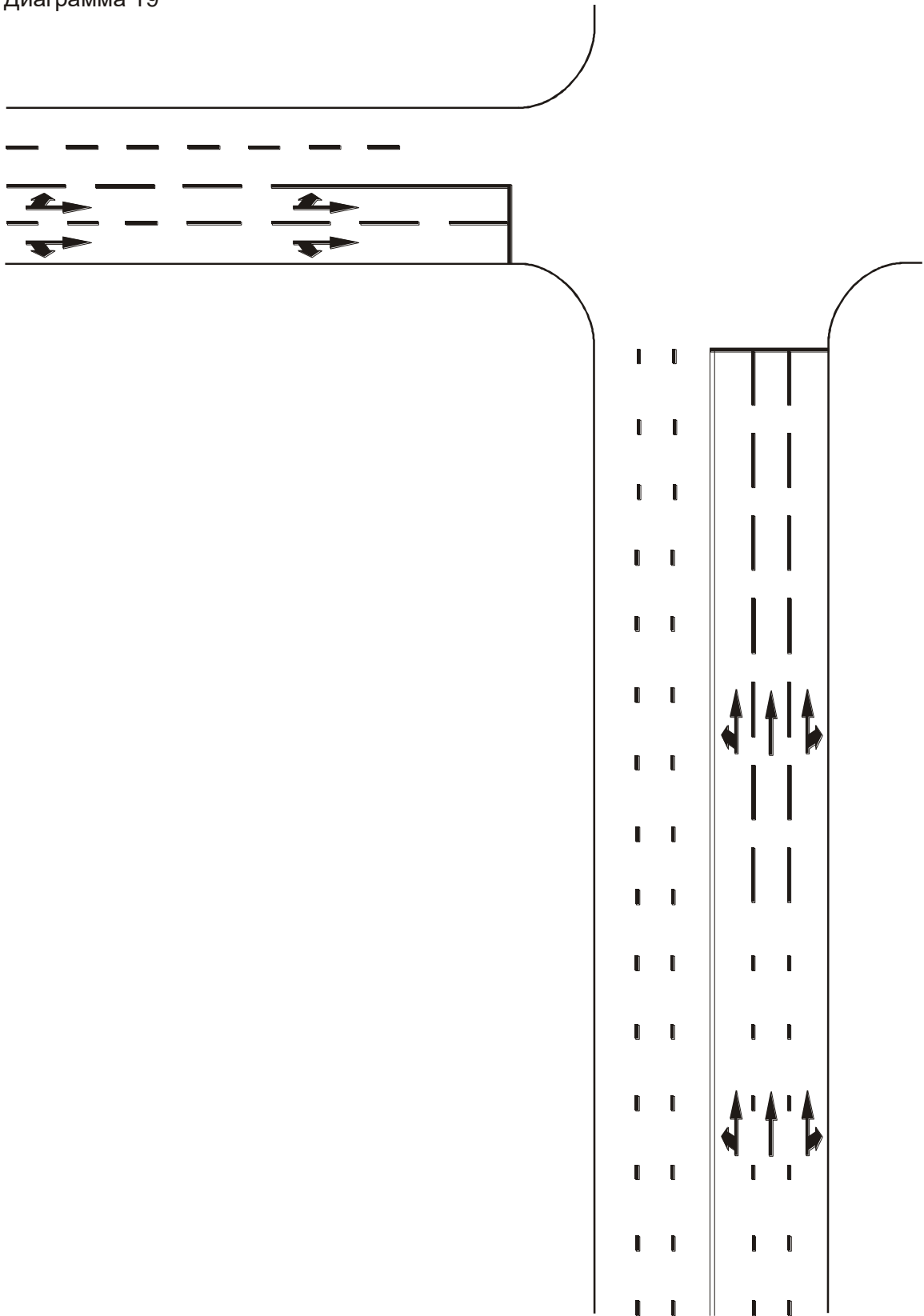

Diagram 20
Diagramme 20
Диаграмма 20

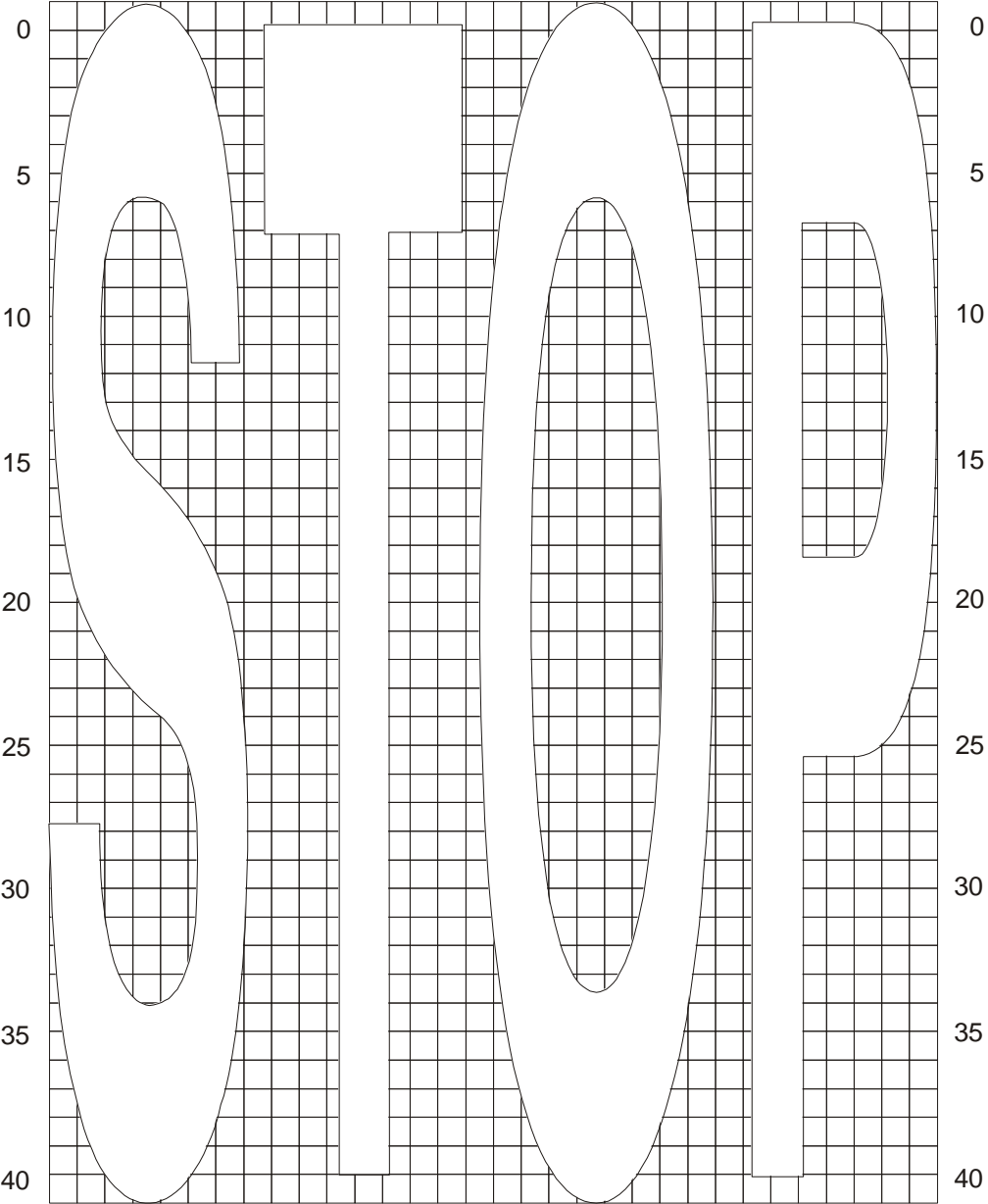
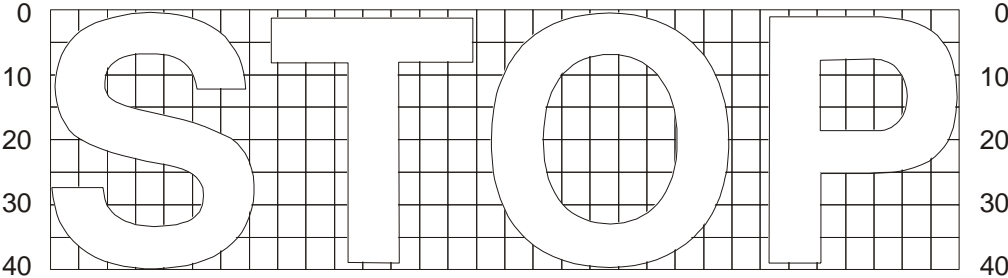

Diagram 21
Diagramme 21
Диаграмма 21

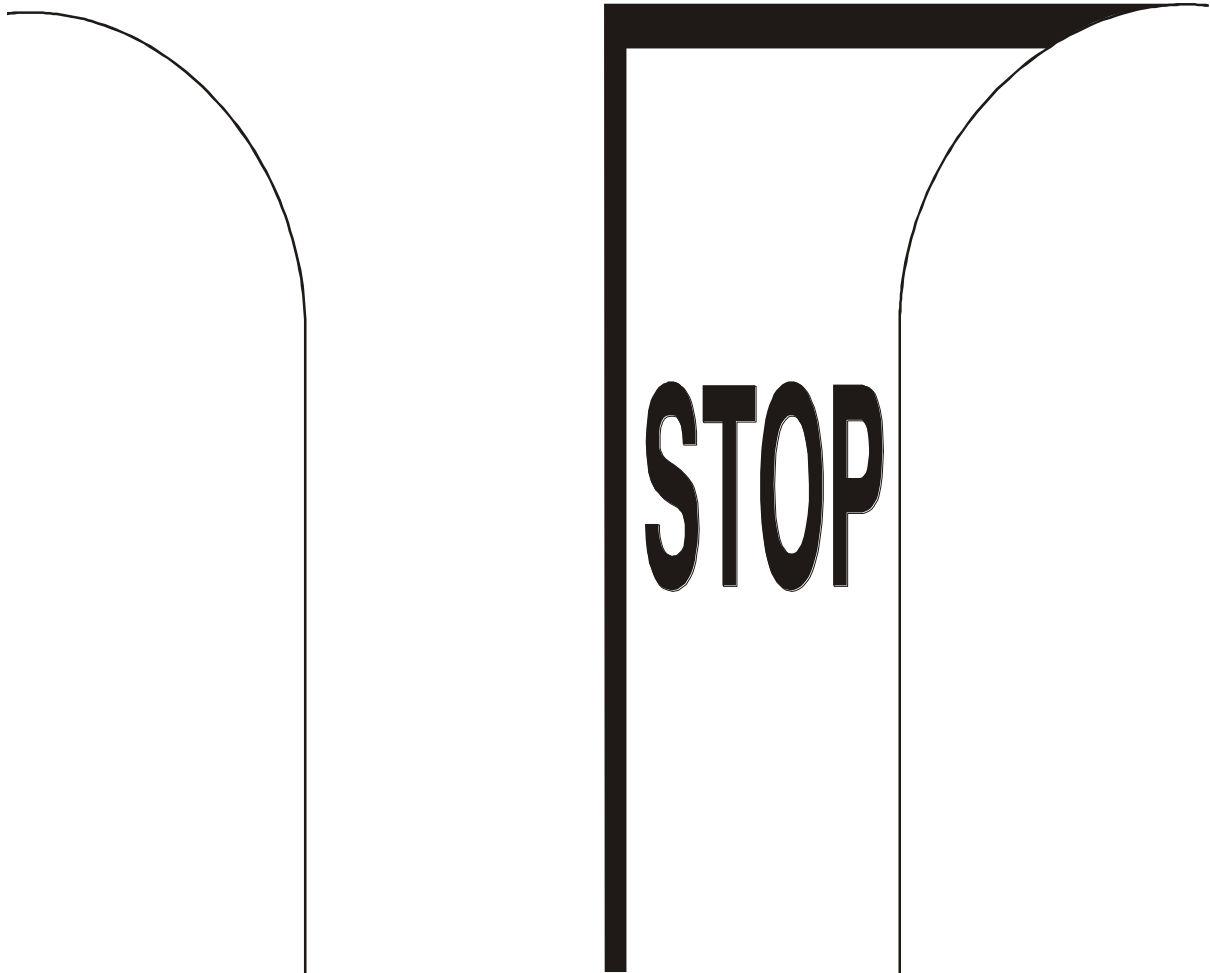

Diagram 22
Diagramme 22
Диаграмма 22

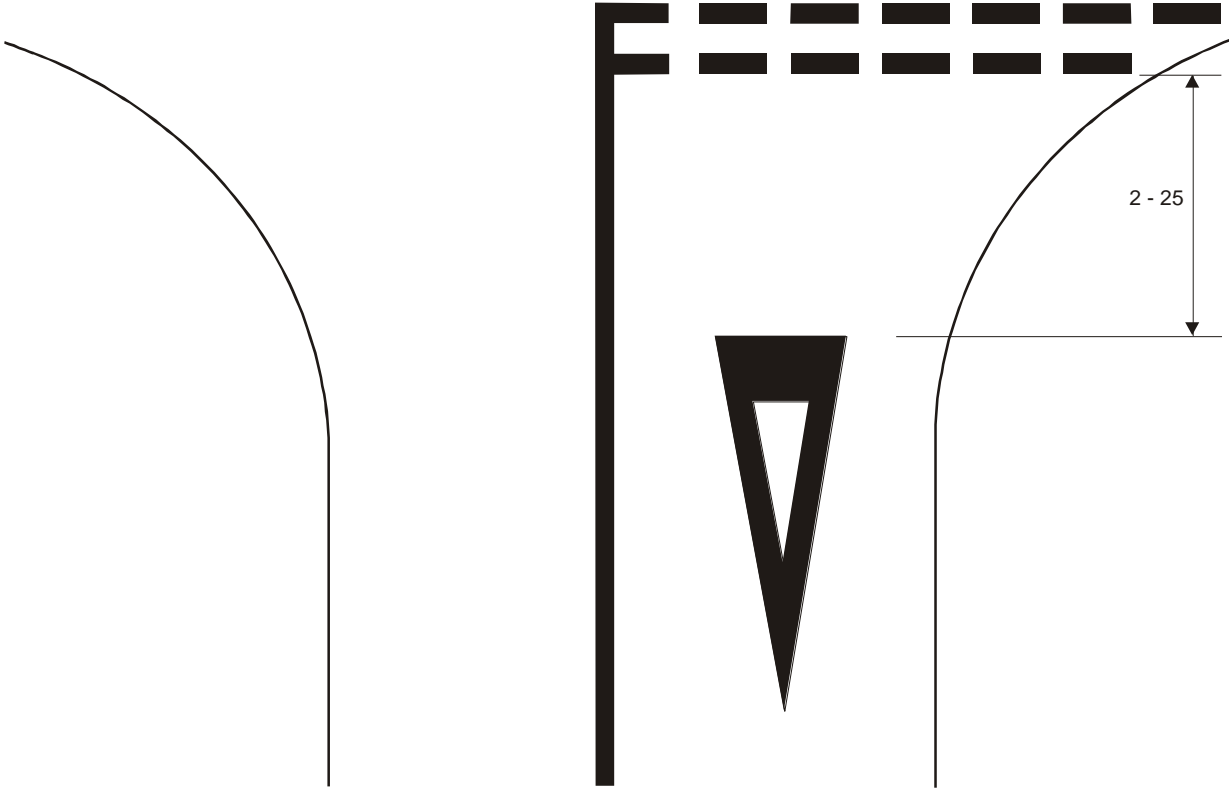

Diagram 23
Diagramme 23
Диаграмма 23

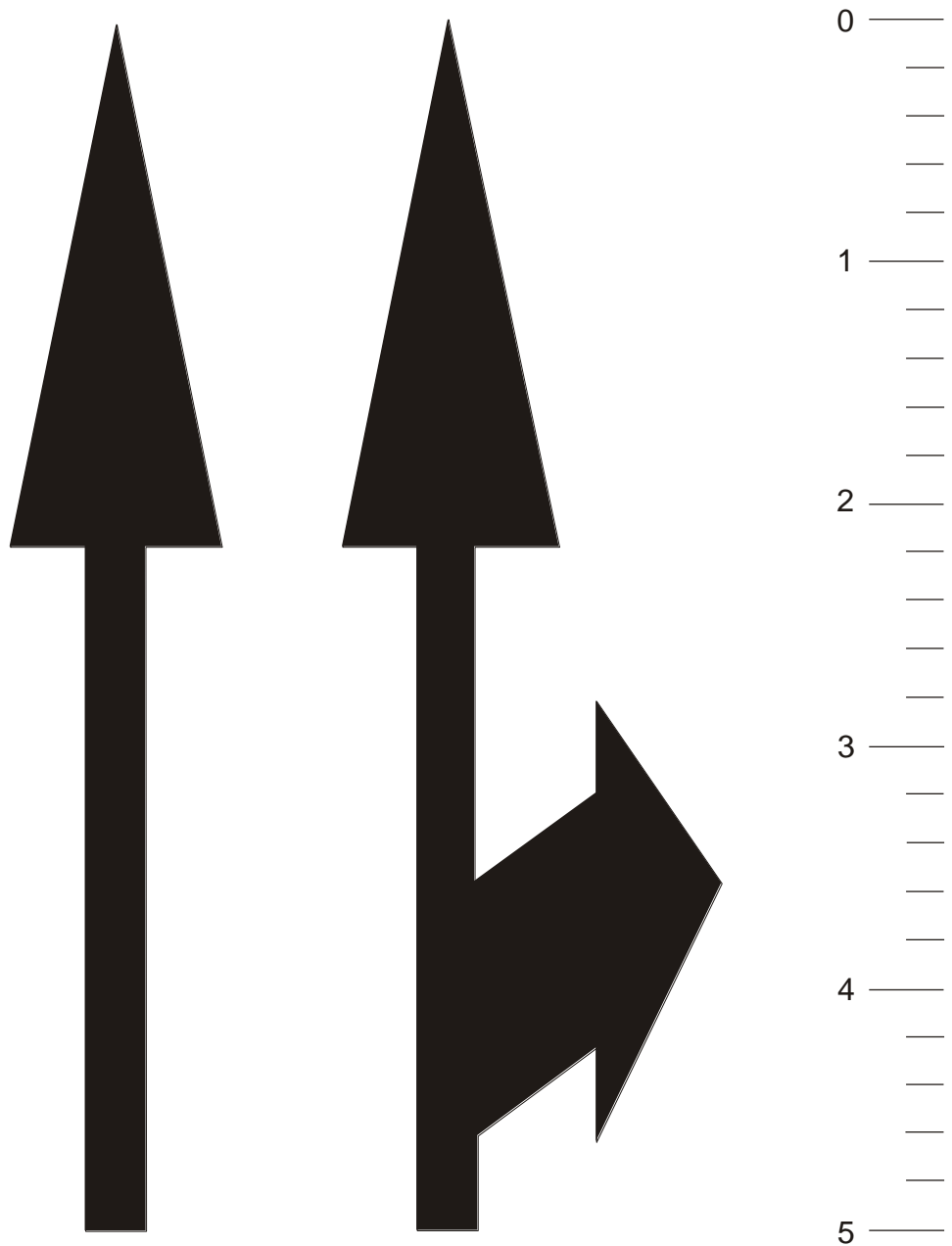

Diagram 24
Diagramme 24
Диаграмма 24

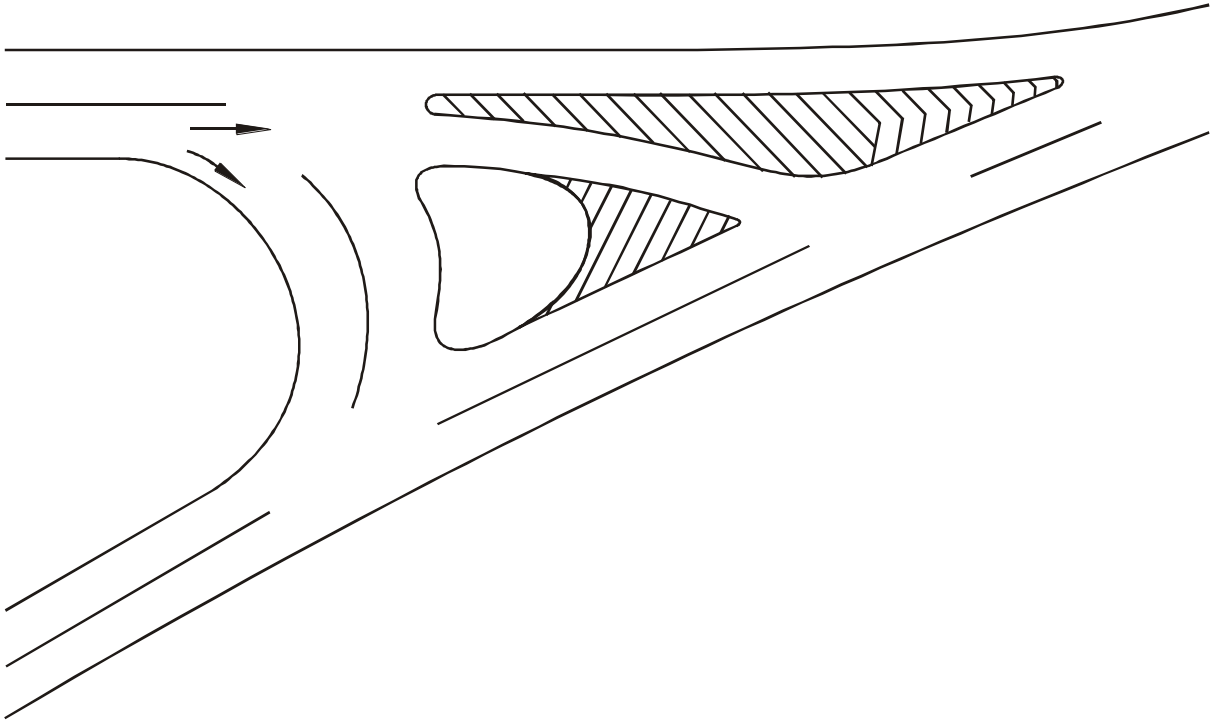

Diagram 25
Diagramme 25
Диаграмма 25

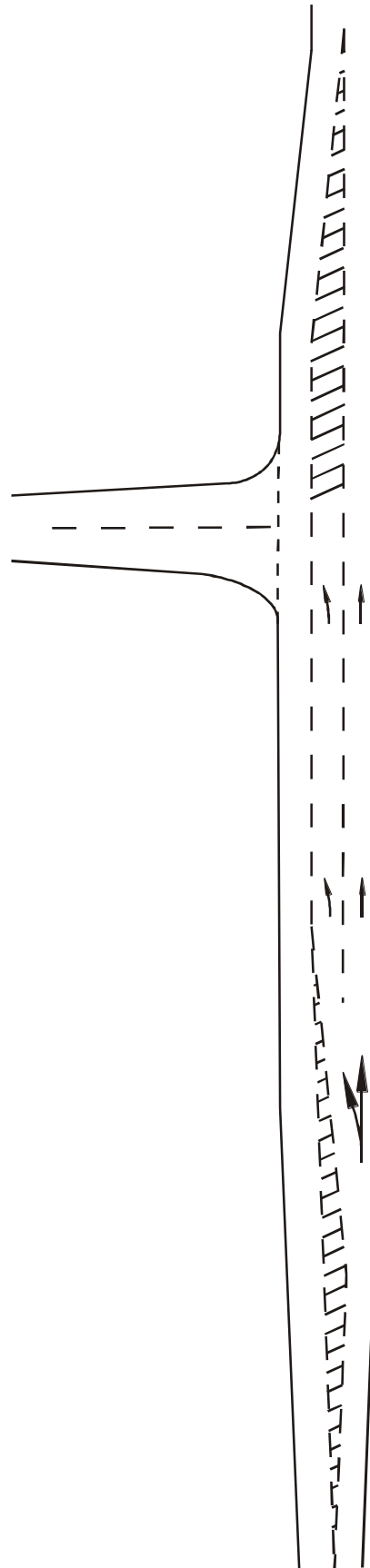

Diagram 26
Diagramme 26
Диаграмма 26

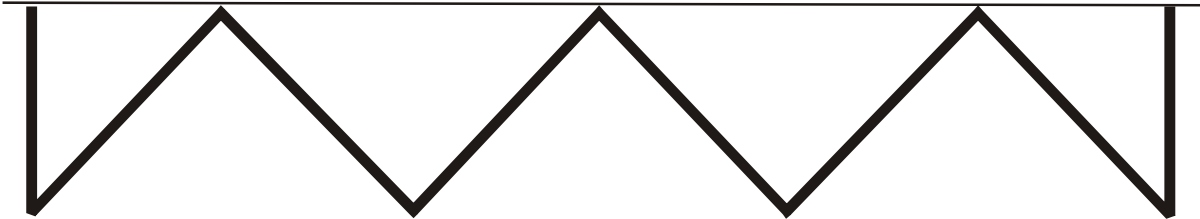

Diagram 27
Diagramme 27
Диаграмма 27

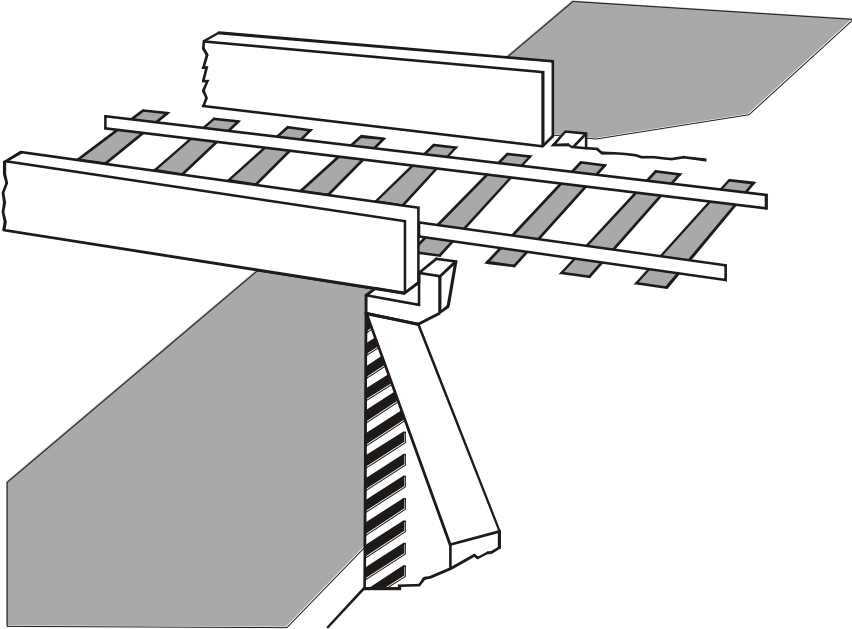
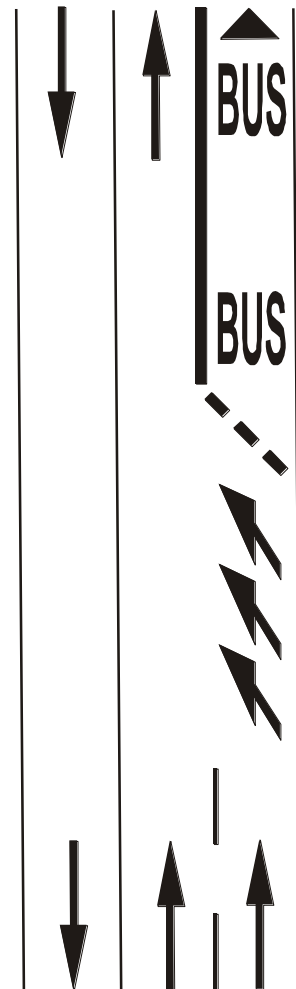
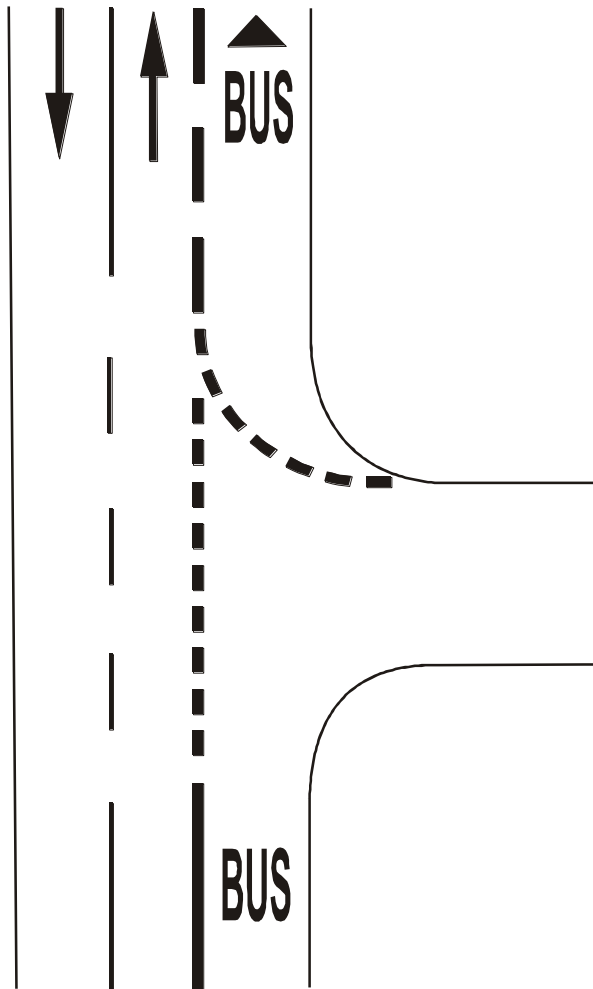

Diagram 28 a
Diagramme 28 a
Диаграмма 28 а

Diagram 28 b
Diagramme 28 b
Диаграмма 28 b



Annex 3

~~REPRODUCTION IN COLOUR OF SIGNS, SYMBOLS AND PANELS REFERRED IN
ANNEX 1~~
