



UNITED NATIONS ECONOMIC COMMISSION FOR EUROPE

UNITED NATIONS CENTRE FOR TRADE FACILITATION
AND ELECTRONIC BUSINESS (UN/CEFACT)

**REQUIREMENTS SPECIFICATION MAPPING
(RSM)**

CCBDA Cross Industry Invoicing v1.0

Approved: UN/CEFACT Bureau on 9 January 2017

Version: 1.0

Release: 0.1

41
42**Contributors**

Name	Organization
Mary Kay Blantz	
Karina Duvinger	
Gerhard Heemskerck (Lead Editor)	
Andreas Pelekies	
Sue Probert	
Natascha Rossner	
Hisanao Sugamata	
Rolf Wessel	

43
44
45
46
47

TABLE OF CONTENTS

48			
49	1	INTRODUCTION.....	4
50	1.1	AUDIENCE	4
51	1.2	REFERENCE DOCUMENTS.....	4
52	2	DOCUMENT HISTORY	6
53	2.1	PURPOSE AND SCOPE.....	6
54	2.2	TARGET SOLUTION	6
55	2.3	BUSINESS REQUIREMENTS SUMMARY	6
56	2.4	BUSINESS PROCESSES, INFORMATION ENVELOPES AND AUTHORISED ROLES	37
57	2.5	BUSINESS PARTNER TYPES AND AUTHORISED ROLES	37
58	2.5.1	<i>Conceptual Model</i>	37
59	2.6	INFORMATION MAPPING.....	38
60	2.6.1	<i>Referenced CCL</i>	38
61	2.6.2	<i>Business Information Entity Model</i>	38
62	2.6.3	<i>Core Components Model Extract</i>	54
63	2.7	LOGICAL MESSAGE STRUCTURE.....	54
64	2.7.1	<i>Message Assembly</i>	54
65	2.7.2	<i>Business Information Entities Used</i>	55
66	2.7.3	<i>Code Lists Used</i>	121
67	2.8	MESSAGE LIBRARY UPDATE.....	128
68	2.8.1	<i>Message Assembly Submission</i>	128
69	2.9	CORE COMPONENT LIBRARY UPDATE	128
70	2.9.1	<i>Referenced CCL</i>	128
71	2.9.2	<i>CCL Update Submission</i>	128
72	2.10	MODEL EXCHANGE FILE	128
73	2.11	ADDITIONAL INFORMATION	128
74	2.12	DEFINITION OF TERMS.....	128
75			
76			
77			

78 1 Introduction

79 The current practice of the exchange of business documents by means of telecommunications –
80 usually defined as e-Business presents a major opportunity to improve the competitiveness of
81 companies, especially for Small and Medium Enterprises (SME).

82
83 The commercial invoice is an important document exchanged between trading partners. In
84 addition to its prime function as a request for payment from the seller to the buyer, the invoice
85 is an important accounting document and, also has potential legal implications for both trading
86 partners. Additionally, e.g., in the member states of the European Union, the invoice is the key
87 document for VAT declaration and reclamation, for statistics declaration, and to support export
88 and import declaration in respect of trade with other countries.

89
90 Started as an initiative by CEN/ISSS Work shop eBES, the European Expert Group 1 (EEG1)
91 – Supply Chain & e-Procurement developed the Cross Industry Invoice in 2004. The Cross
92 Industry Invoice has been compiled using the EUROFER ESIDEL version 1.0 as the base, with
93 contributions and submissions from: EUROFER, GS1, CIDX, EDIFICE, AIAG / ODETTE
94 /JAMA, GHX and EDS.

95
96 The first draft of the Business Requirements Specification (BRS) was presented at the
97 September 2004 UN/CEFACT Forum to the TBG1 members for review and comments from
98 the other regions. In 2008 version 2.0 of the BRS document was released. Version 2.0 of the
99 BRS was taken as the basis to develop the Requirements Specification Mapping (RSM)
100 version 2.00 and 2.01.

101
102 The structure of this document is based on the structure of the UN/CEFACT Requirements
103 Specification Mapping (RSM) – Documentation Template Guidelines.

105 1.1 Audience

106 The main audiences for this document are the potential authors of individual RSMs. These
107 are primarily the UN/CEFACT business and IT experts who are responsible for specifying
108 the business requirements for e-business solutions in a specific domain and for furthering
109 the development of solutions as relevant standards. Authors may include other standards
110 bodies or users and developers in developed or developing economies.

112 1.2 Reference Documents

113 Knowledge and application of the following standards is crucial to the development of
114 quality business requirements specifications. Other key references are shown in the
115 appropriate part of the document.

- 116
117 - UN/CEFACT. Techniques and Methodologies Group (TMG). UN/CEFACT's
118 Modelling Methodology (UMM): UMM Meta Model Core Module. (Candidate for
119 2.0). 2009-01-30.

120
121 Formal definitions of many of the technical terms used in this RSM guideline may be found
122 in the above references but for convenience some key definitions are included in Annex 1 of
123 this document.

124

- 125 - UN/CEFACT Core Components Technical Specification – Part 8 of the ebXML
126 Framework dated 15 November 2003 Version 2.01 - (CCTS 2.01)
127 - UN/CEFACT – Core Component Technical Specification *Technical Corrigendum*
128 Version 2.01 (Corr. 1) dated 12 February 2007 (CCTS 2.01 Corr.1)
129 - UN/CEFACT Core Components Data Type Catalogue Version 2.1 dated 2008-04-08
130 (CCDTC 2.1)
131 - UN/CEFACT XML Naming and Design Rules Version 2.0, dated 17 February 2006
132 (NDR 2)
133 - UN/CEFACT UML Profile for Core Components (UPCC), Version 1.0, Final
134 Specification, 2008-01-16
135 - UN/CEFACT Core Components Business Document Assembly Technical Specification
136 (CCBDA) version 1.0
137 - UN/CEFACT Business Requirement Specification Cross Industry Invoicing Process
138 Version 2.0.6.
139

140 In this document the set of CCTS 2.01 / CCTS 2.01 Corr.1 / NDR 2 / CCDTC 2.1
141 specifications are referred to as "UN/CEFACT Technical Specifications Version 2"..
142
143
144

145

146 2 Document History

147 Table 1: Document History

Phase	Status	Date Last Modified
ODP 3	Draft Development	30-05-2016
ODP 4	Public Review	06-21-2016
ODP 5	Publication	

148

149 Table 2: Change Log

Date of Change	Version	Paragraph Changed	Summary of Changes	Author
01-14-2016	0.4		Proof of Concept CCBDA CII	Gerhard Heemskerk (Lead Editor)
05-30-2016	1.0		12B : INV-0296 till INV-0310 16A : INV-0311 till INV-0312 16A.1: INV-0030, INV-0158, INV-0189, INV-0169, INV-0195, INV-0295, INV-0013, INV-0134, INV-0313 till INV-0321	Gerhard Heemskerk (Lead Editor)
10-10-2016	1.0		Public Review comments processed (editorial comments)	Gerhard Heemskerk (Lead Editor)

150

151 2.1 Purpose and Scope

152

153

154

155

156

157

158

159

160

161

This project aims to standardize the business process and information entities of cross-industrial electronic invoicing. In various industries all over the world, there are all sorts of invoicing actions being performed. With the explosive spread of the Internet and the rapid growth of information technology, invoicing activity is being performed electronically through the Internet as well as other business activities. With the realization of electronic invoicing through the Internet and spreading practice of international electronic invoicing, the needs for international standardization are thought to increase. According to such trends, the goal of this project is to make the business process and information entities within invoicing activities standard.

162 2.2 Target Solution

163

164

165

The target solution is an implementation using XML schema based on the following UN/CEFACT specifications: CCTS 2.01, NDR 2.1, CCBDA 1.0 and the UN/CEFACT standard Supply Chain Reference Data Model.

166 2.3 Business Requirements Summary

167

168

169

In conjunction with the BRS document (UN/CEFACT Business Requirement Specification Cross Industry Invoicing Process Version 2.0.6), the purpose of this document is to provide a standard framework for the exchange of information.

170

171 Table 1-1 Business Requirements List

UID	Crđ	Short Name	Business Requirement	Rationale / Example / Mapping Notes / Status	Mapping to Dictionary Entry Name
CII			BRS : Cross Industry Invoicing Process		
			Header section		

UID	Crđ	Short Name	Business Requirement	Rationale / Example / Mapping Notes / Status	Mapping to Dictionary Entry Name
Grouping of Document Details					
INV-0001	1..1	Invoice identifier	A unique identification for this document.		Exchanged_Document. Identification. Identifier
INV-0002	1..1	Issue date	The date, time, date time or other date time value for the issuance of this document.		Exchanged_Document. Issue. Date Time
INV-0003	0..1	Document type code	A code specifying a type of document [Reference United Nations Code List (UNCL) 1001 (subset)].	Specifying the type of the invoice, e.g.: <ul style="list-style-type: none"> ■ Commercial invoice ■ Self-billed invoice ■ Proforma invoice ■ Corrected invoice ■ Credit note – goods and services ■ Debit note – goods and services ■ Credit note related to financial adjustments ■ Debit note related to financial adjustments ■ Self-billed credit note 	Exchanged_Document. Type. Code
INV-0007	0..1	Document Purpose	The purpose, expressed as code, of this document (e.g. Repair Invoice).	Exchanged Document Category	Exchanged_Document. Purpose. Code
INV-0008	0..1	Document Purpose Information	The purpose, expressed in text, of this document.	Renamed, formerly "Document Information"	Exchanged_Document. Purpose. Text
INV-0011	0..1	Document Control Requirement	The indication of whether or not a document has specific control requirements.		Exchanged_Document. Control Requirement. Indicator

UID	Crđ	Short Name	Business Requirement	Rationale / Example / Mapping Notes / Status	Mapping to Dictionary Entry Name
INV-0313	0..1	Test indicator	The indication of whether or not this exchanged document context is a test.	Added in 16A.1.	Exchanged Document_ Context. Test. Indicator
INV-0314	0..1	Effective Specified Period	The specified period within which this exchanged document is effective.	Added in 16A.1.	Exchanged_ Document. Effective. Specified_ Period
For additional requirements on document details please refer to CSC-DOC.					
Grouping of Header Trade Agreement					
INV-0016	0..1	Seller	The entity contains the details of the seller.	Further details specified in Common BRS (CSC-PAR)	Header_ Trade Agreement. Seller. Trade_ Party
INV-0017	0..1	Buyer	The entity contains the details of the buyer.	Further details specified in Common BRS (CSC-PAR)	Header_ Trade Agreement. Buyer. Trade_ Party
INV-0018	0..1	Buyer's tax representative	The entity contains the details of the tax representative of the buyer.	Split into Seller and Buyer (see INV-00250) within TBG1 review, originally tax representative, not specified. Details see CSC-PAR	Header_ Trade Agreement. Buyer_ Tax Representative. Trade_ Party
INV-0250	0..1	Seller's tax representative	The entity contains the details of the tax representative of the seller.	See previous note. Details see CSC-PAR	Header_ Trade Agreement. Seller_ Tax Representative. Trade_ Party
INV-0019	0..1	Buyer accountant	The entity contains the details of the customer accountant.	Changed from Customer to Buyer within TBG1 review. Details see CSC-PAR	Header_ Trade Agreement. Buyer_ Assigned Accountant. Trade_ Party
INV-0020	0..1	Seller accountant	The entity contains the details of the supplier accountant.	Changed from Supplier to Seller within TBG1 review. Details see CSC-PAR	Header_ Trade Agreement. Seller_ Assigned Accountant. Trade_ Party
INV-0289	0..*	Requisitioner	A trade party who is a buyer requisitioner in this	Added during CEFAC Forum Rome by TBG1,	Header_ Trade Agreement. Buyer_

UID	Crđ	Short Name	Business Requirement	Rationale / Example / Mapping Notes / Status	Mapping to Dictionary Entry Name
			trade agreement.	22-Apr-2009 Details see CSC-PAR	Requisitioner. Trade_Party
INV-0021	0..1	Contract document	Reference to contract or agreement document (reference, issue date, involved parties, etc.)	Details see CSC-REF	Header_Trade Agreement. Contract. Referenced_Document
INV-0022	0..1	Quotation document	Reference to quotation document (reference, issue date, involved parties, etc.)	Details see CSC-REF	Header_Trade Agreement. Quotation. Referenced_Document
INV-0023	0..1	Order document (buyer)	Reference to order document of the buyer (reference, issue date, involved parties, etc.)	Buyer added within TBG 1 review. Details see CSC-REF	Header_Trade Agreement. Buyer_Order. Referenced_Document
INV-0251	0..1	Order document (Seller)	Reference to order document of the seller (reference, issue date, involved parties, etc.)	Added in addition to INV-0023 within TBG 1 review. Details see CSC-REF	Header_Trade Agreement. Seller_Order. Referenced_Document
INV-0024	0..1	Order Response document	Reference to order response document (reference, issue date, involved parties, etc.)	Details see CSC-REF	Header_Trade Agreement. Order Response. Referenced_Document
INV-0025	0..1	Promotional Deal document	Reference to promotional deal document (reference, issue date, involved parties, etc.)	Details see CSC-REF	Header_Trade Agreement. Promotional Deal. Referenced_Document
INV-0026	0..1	Price list document	Reference to price list document (reference, issue date, involved parties, etc.)	Details see CSC-REF	Header_Trade Agreement. Price List. Referenced_Document
INV-0027	0..1	Supply instruction document	Reference to supply instruction document (reference, issue date, involved parties, etc.)	Details see CSC-REF	Header_Trade Agreement. Supply Instruction. Referenced_Document

UID	Crd	Short Name	Business Requirement	Rationale / Example / Mapping Notes / Status	Mapping to Dictionary Entry Name
INV-0028	0..1	Demand forecast document	Reference to demand forecast document (reference, issue date, involved parties, etc.)	Details see CSC-REF	Header_ Trade Agreement. Demand Forecast. Referenced_ Document
INV-0291	0..*	Requisitioner reference	The requisitioner document referenced in this supply chain trade agreement.	Added during CEFACT Forum Rome by TBG1, 22-Apr-2009 Details see CSC-REF	Header_ Trade Agreement. Requisitioner. Referenced_ Document
INV-0030	0..1	Purchase Conditions	Reference to purchase conditions	Details see CSC-Added in 16A.1	Header_ Trade Agreement. Purchase_ Conditions Referenced_ Document
INV-0031	0..*	Additional document reference	Reference to an additional document (reference, issue date, involved parties, etc.)	Details see CSC-REF	Header_ Trade Agreement. Additional. Referenced_ Document
INV-0032	0..1	Additional document type	A code specifying a type of referenced document [Reference United Nations Code List (UNCL) 1153].	Cardinality changed from 0..* to 0..1 as it refers to INV-0031.	Referenced_ Document. Reference_ Type. Code
INV-0033	0..1	Delivery terms	The entity contains the details of the delivery terms and the place if relevant for the delivery terms.	Includes reference to INCOTERMS	Header_ Trade Agreement. Applicable. Trade_ Delivery Terms
INV-311	0..1	Procuring Project	An endeavour carefully planned to achieve a procurement of goods, works and service.	Added in 16A.	Header_ Trade Agreement. Specified. Procuring_ Project
INV-0315	0..1	Product End User	The party acting as the end user for the products in this trade agreement.	Added in 16A.1	Header_ Trade Agreement. Product End User. Trade_ Party
INV-0319	0..*	Reference Text	A reference, expressed as text, for this header trade agreement.	Added in 16A.1	Header_ Trade Agreement. Reference. Text

UID	Crđ	Short Name	Business Requirement	Rationale / Example / Mapping Notes / Status	Mapping to Dictionary Entry Name
INV-0320	0..*	Customer Order reference	A customer order document referenced for this header trade agreement.	Postponed	
Grouping of Header Trade Delivery Details					
INV-0034	0..1	Delivery date, actual	Date/time on which goods or consignment are delivered at their destination.	Also applicable for service completion date. Includes also the indication of delivery periods.	Header_Trade Delivery. Actual_Delivery. Supply Chain_Event
INV-0035	0..1	Pick Up date, actual	Pick-up/collection date/time of goods		Header_Trade Delivery. Actual_Pick-Up. Supply Chain_Event
INV-0036	0..1	Despatch Date, actual	Date/time on which the goods are despatched or shipped.	Changed to actual during TBG1 review.	Header_Trade Delivery. Actual_Despatch. Supply Chain_Event
INV-0038	0..*	Despatch advice document	Reference to despatch advice document (reference, issue date, involved parties, etc.)	Details see CSC-REF	Header_Trade Delivery. Despatch Advice. Referenced_Document
INV-0039	0..*	Receiving advice document	Reference to receiving advice document (reference, issue date, etc.)	Cardinality changed in TBG1 review. Details see CSC-REF	Header_Trade Delivery. Receiving Advice. Referenced_Document
INV-0040	0..*	Delivery note document	Reference to delivery note document (reference, issue date, etc.)	Cardinality changed in TBG1 review. Details see CSC-REF	Header_Trade Delivery. Delivery Note. Referenced_Document
INV-0041	0..*	Additional document reference	Reference to additional document (reference, issue date, involved parties, etc.)	e.g., packing list, waybill, bill of lading, consumption report also customs documents like export/import license, goods or services	Header_Trade Delivery. Additional. Referenced_Document

UID	Crd	Short Name	Business Requirement	Rationale / Example / Mapping Notes / Status	Mapping to Dictionary Entry Name
				declaration, etc. Details see CSC-REF	
INV-0042	0..1	Additional document type	A code specifying a type of additional document [Reference United Nations Code List (UNCL) 1153].	Cardinality changed from 0..* to 0..1 as it refers to INV-0041.	Referenced_Document. Reference_Type. Code
INV-0043	0..1	Ship to party	The party where the goods or services were delivered or where the service was completed.	Details see CSC-PAR	Header_Trade Delivery. Ship To. Trade_Party
INV-0044	0..1	Ship from party	Party where goods or services are shipped from.	Details see CSC-PAR	Header_Trade Delivery. Ship From. Trade_Party
INV-0045	0..1	Pick up party	Party/Place where goods were picked up by the buyer or his representative	Details see CSC-PAR	Header_Trade Delivery. Actual_Pick-Up. Supply Chain_Event / Supply Chain_Event. Occurrence. Logistics_Location
INV-0046	0..1	Consignor party	Party which, by contract with a carrier, consigns or sends goods with the carrier, or has them conveyed by him. Synonym: shipper, sender.	Details see CSC-PAR	Supply Chain_Consignment. Consignor. Trade_Party
INV-0047	0..1	Consignee party	Party to which goods are consigned.	Details see CSC-PAR	Supply Chain_Consignment. Consignee. Trade_Party
INV-0048	0..1	Ultimate Consignee	Party who has been designated on the invoice or packing list as the final recipient of the stated merchandise.	Used in cross-docking scenarios Details see CSC-PAR	Header_Trade Delivery. Ultimate_Ship To. Trade_Party

UID	Crđ	Short Name	Business Requirement	Rationale / Example / Mapping Notes / Status	Mapping to Dictionary Entry Name
INV-0049	0..1	Ultimate Customer	End customer, the final recipient of goods or services.	Used to identify the end consumer. Mapping into Ultimate_ShipTo. Same mapping applies for 0048 and 0049. Details see CSC-PAR	Header_ Trade Delivery. Ultimate_Ship To. Trade_ Party
INV-0050	0..1	Country of supply of goods or services	The country from which the delivery has taken place		Trade_ Tax. Service Supply. Trade_ Country
INV-0051	0..1	Transport mode	The code specifying the mode of transport.		Logistics_ Transport Movement. Mode. Code
INV-0052	0..1	Transport means	The entity contains details regarding the transport means (e.g., license plate of the lorry, wagon number, name of the vessel).	Further details see Common BRS (CSC-TME)	Logistics_ Transport Movement. Used. Logistics_ Transport Means
Grouping of Header Trade Settlement Details					
INV-0053	0..*	Total to be paid amount	The monetary value that constitutes the total to be paid on which the trade settlement is calculated.		Trade Settlement Header_ Monetary Summation. Total Prepaid. Amount
INV-0056	0..*	Total prepaid amount	The monetary value that constitutes the total paid for an advance and on which the trade settlement is calculated.		Trade Settlement Header_ Monetary Summation. Total Prepaid. Amount
INV-0058	0..*	Total line items amount of the invoice	The monetary value that constitutes the total line items on which the trade settlement is calculated.	Cardinality changed during TBG 1 review	Trade Settlement Header_ Monetary Summation. Line Total. Amount
INV-0059	0..*	Total allowances charges amount of the invoice	The monetary value that constitutes the total allowances charges on which the trade settlement	Cardinality changed during TBG 1 review	Trade Settlement Header_ Monetary

UID	Crđ	Short Name	Business Requirement	Rationale / Example / Mapping Notes / Status	Mapping to Dictionary Entry Name
			is calculated.		Summation. Allowance Total. Amount
INV-0252	0..*	Total allowances amount of the invoice	The monetary value that constitutes the total allowances on which the trade settlement is calculated.	Agreed in Paris TBG 1, 28-Aug2008 in addition to INV-0059	Trade Settlement Header_Monetary Summation. Allowance Total. Amount
INV-0253	0..*	Total charges amount of the invoice	The monetary value that constitutes the total charges on which the trade settlement is calculated.	Agreed in Paris TBG 1, 28-Aug2008 in addition to INV-0059	Trade Settlement Header_Monetary Summation. Charge Total. Amount
INV-0060	0..*	Total amount	The monetary value that constitutes the total invoice or credit note on which the trade settlement is calculated.	Renamed to Total amount from Total invoice amount in order to cover invoice and credit note amount.	Trade Settlement Header_Monetary Summation. Grand Total. Amount
INV-0061	0..*	Total tax amount of the invoice	The monetary value that constitutes the total tax on which the trade settlement is calculated.		Trade Settlement Header_Monetary Summation. Tax Total. Amount
INV-0062	0..*	Total tax basis amount of the invoice	The monetary value that constitutes the total tax basis on which the trade settlement is calculated.		Trade Settlement Header_Monetary Summation. Tax Basis Total. Amount
INV-0063	0..*	Total rounding amount	The monetary value that constitutes the total rounding on which the trade settlement is calculated.		Trade Settlement Header_Monetary Summation. Rounding. Amount
INV-0064	0..*	Total Information amount	The monetary value that constitutes the information total on	Can be used for the monetary value that	Trade Settlement

UID	Crđ	Short Name	Business Requirement	Rationale / Example / Mapping Notes / Status	Mapping to Dictionary Entry Name
			which the trade settlement is calculated.	constitutes the total of a previous invoice to be paid. Code list needs to be developed (based on DE 5025) <ul style="list-style-type: none"> • Total retail value • Total returnable items deposit amount • Calculation basis excluding all taxes • Calculation basis including all taxes except VAT • Message total duty/tax/fee amount 	Header_Monetary Summation. Information. Amount
INV-0065	0..1	Total amount subject to payment discount	Part of the invoice amount which is subject to payment discount.		Trade_Payment Discount Terms. Actual Discount. Amount
INV-0067	0..*	Adjustment	Specifying the adjustment.	Includes amount, reason, etc.	Header_Trade Delivery. Specified. Delivery_Adjustment
INV-0068	0..1	Credit reason	Reason why credit was issued in credit note	Added in 10A.	Header_Trade Settlement. Credit Reason. Code / Header_Trade Settlement. Credit Reason. Text
INV-0069	0..1	Tax point date	The date of the tax point when taxes are or will be applicable.	covered within CSC-Tax within Common BRS	Applied_Tax. Tax Point. Date
INV-0280	0..1	Tax due date code	A code indicating when the duty, tax, or fee payment will be due.	Refer to EDIFACT, DE 5307. Added during CEFACT Forum Rome, 22-Apr-2009.	Trade_Payment Terms. Due Date. Date Time

UID	Crđ	Short Name	Business Requirement	Rationale / Example / Mapping Notes / Status	Mapping to Dictionary Entry Name
INV-0070	0..1	Billing period	A specific period of time such as the length of time between two known date/time points, from a start date onwards, or up to an end date.		Header_ Trade Settlement. Billing. Specified_Period
INV-0071	0..1	Invoicer party	The invoicer is the person or organization making the invoice, claiming payment for the goods or services rendered.	Details see CSC-PAR	Header_ Trade Settlement. Invoicer. Trade_Party
INV-0072	0..1	Invoicee party	The invoicee party is the person or organization who will receive the invoice for the delivery of products or services.	Details see CSC-PAR	Header_ Trade Settlement. Invoicee. Trade_Party
INV-0073	0..1	Payer party	The payer is the person or organization responsible for the payment.	Details see CSC-PAR	Header_ Trade Settlement. Payer. Trade_Party
INV-0074	0..*	Payee party	The payee party is the person or organization to whom a payment should be or is made.	Cardinality 0..* means that various payees can occur in one invoice, related to Payment Means and Payment Terms. The cardinality of 0..* needs further discussion. In 09A only a cardinality of 0..1 will be supported. Details see CSC-PAR	Header_ Trade Settlement. Payee. Trade_Party
INV-0079	0..1	Invoice document	Reference to invoice document (reference, issue date, involved parties, etc.) of a previously sent invoice	Details see CSC-REF	Header_ Trade Settlement. Invoice. Referenced_Document
INV-0080	0..1	Pro-forma invoice document	Reference to pro-forma invoice document (reference, issue date, involved	Details see CSC-REF	Header_ Trade Settlement. Pro-Forma Invoice.

UID	Crđ	Short Name	Business Requirement	Rationale / Example / Mapping Notes / Status	Mapping to Dictionary Entry Name
			parties, etc.)		Referenced_ Document
INV-0081	0..1	Letter of credit reference	Reference to a letter of credit document. This requirement refers to Stand-By Letter of Credit, also called Documentary Credit in Anglo-American.	The Stand-By Letter of Credit is a guarantee of payment. Definition changed (see INV0082). Details see CSC-REF	Header_ Trade Settlement. Letter Of Credit. Referenced_ Document
INV-0083	0..*	Applicable Tax	A levy or payment for the support of a government required of persons, groups, or businesses within the domain of that government.	Further details see Common BRS (CSC-TAX) Note: Includes Place of Supply	Header_ Trade Settlement. Applicable. Trade_ Tax
INV-0316	0..*	Tax - Line Total Basis. Amount	A monetary value used as the line total basis on which this trade related tax, levy or duty is calculated.	Added in 16A.1	Trade_ Tax. Line Total_ Basis. Amount
INV-0317	0..*	Tax - Allowance Charge_ Basis. Amount	A monetary value used as the allowance and charge basis on which this trade related tax, levy or duty is calculated.	Added in 16A.1	Trade_ Tax. Allowance Charge_ Basis. Amount
INV-0256	0..*	Calculated Tax	The calculated tax for the invoice.	Added in TBG 1 review. Further details see Common BRS (CSC-TAX)	Header_ Trade Settlement. Subtotal_ Calculated. Trade_ Tax
INV-0257	0..*	Tax scheme	Specifying the tax scheme for the calculated or applicable tax.	Added in TBG 1 review. Further details see Common BRS (CSC-TXS)	Trade_ Tax. Category. Code
INV-0088	0..*	Tax basis amount per rate	Total taxable amount for the given tax rate and tax category	May 2009: Implemented as Subtotal_ Calculated. Trade_ Tax. For further details see Common BRS (CSC-TAX).	Applied_ Tax. Details / Applied_ Tax. Basis. Amount

UID	Crđ	Short Name	Business Requirement	Rationale / Example / Mapping Notes / Status	Mapping to Dictionary Entry Name
INV-0089	0..*	Tax amount per rate	The total amount of tax per tax rate and tax category	May 2009: Implemented as Subtotal_Calculated. Trade_Tax. For further details see Common BRS (CSC-TAX).	Trade Settlement Header_Monetary Summation. Tax Total. Amount
INV-0090	0..*	Tax amount per rate in VAT currency	The total amount of tax per tax rate and tax category in VAT currency	May 2009: Implemented as Subtotal_Calculated. Trade_Tax. For further details see Common BRS (CSC-TAX).	Header_Trade Settlement. Tax_Currency. Code / Trade_Tax. Category. Code
INV-0091	0..*	Total allowances/charges amount per tax rate	Total allowances / charges amount per tax rate and category	May 2009: Implemented as Subtotal_Calculated. Trade_Tax. For further details see Common BRS (CSC-TAX). Not covered in 09A, moved to 09B.	Line_Trade Settlement. Specified. Trade_Allowance Charge
INV-0092	0..*	Total of all line item amounts per tax rate	Sum of all line item amounts per tax rate and category	May 2009: Implemented as Subtotal_Calculated. Trade_Tax. For further details see Common BRS (CSC-TAX). Not covered in 09A, moved to 09B.	Header_Trade Settlement. Specified. Trade Settlement Header_Monetary Summation
INV-0258	0..*	Payment Terms	Specifying payment terms for this document.	Added during TBG1 review to align with Common BRS. Further details see Common BRS (CSC-PYT) Note: Includes reference to direct debit mandate.	Header_Trade Settlement. Specified. Trade_Payment Terms
INV-0097	0..1	Payment Terms Discount Due Date	Date by which payment should be made if discount terms are to apply.		Header_Trade Settlement. Specified. Trade_Payment Terms

UID	Crd	Short Name	Business Requirement	Rationale / Example / Mapping Notes / Status	Mapping to Dictionary Entry Name
					Trade_ Payment Terms. Due Date. Date Time
INV-0103	0..*	Payment Means	A payment means specified for this trade settlement.	Usage of DE 4461 (Cheque, cash, bank account etc.) Including Accounts of payer, payee. Further details in Common. Supply Chain BRS. (CSC-PYM)	Header_ Trade Settlement. Specified. Trade Settlement_ Payment Means
INV-0104	0..*	Allowance and/or charge details	Details regarding allowances and charges	Further details in Common Supply Chain BRS. (CSC-ALC)	Header_ Trade Settlement. Specified. Trade_ Allowance Charge
INV-0105	0..*	Allowance and/or charge rate	Rate per unit which the allowance or charge applies, e.g., the allowance/charge amount is 3 EUR per 10 tons.	Added in 09A.	Header_ Trade Settlement. Specified. Trade_ Allowance Charge. Calculation. Percent
INV-0106	0..*	Allowance and/or charge rate basis	Basis for the rate per unit which the allowance or charge applies, e.g., the allowance/charge amount is 3 EUR per 10 tons.	Added in 09A.	Header_ Trade Settlement. Specified. Trade_ Allowance Charge. Basis. Amount / Header_ Trade Settlement. Specified. Trade_ Allowance Charge. Unit_ Basis. Amount
INV-0107	0..*	Freight Charge	Charge for freight	If not included in allowances and charges	Supply Chain_ Consignment. Total Charge. Amount

UID	Crđ	Short Name	Business Requirement	Rationale / Example / Mapping Notes / Status	Mapping to Dictionary Entry Name
INV-0108	0..1	Invoice Currency	The name or symbol of the monetary unit used for calculation in an invoice.		Header_ Trade Settlement. Invoice_ Applicable. Trade_ Currency Exchange
INV-0109	0..1	Tax Currency	The name or symbol of the monetary unit used for tax purposes.		Header_ Trade Settlement. Tax_ Applicable. Trade_ Currency Exchange
INV-0110	0..1	Payment Currency	The name or symbol of the monetary unit used for payment.		Header_ Trade Settlement. Payment_ Applicable. Trade_ Currency Exchange
INV-0263	0..1	Creditor Reference	The unique identifier of the creditor reference for this trade settlement, such as a specific identifier assigned by the creditor to refer to the financial transaction.	Added during TBG steering review Oct-2008.	Header_ Trade Settlement. Creditor Reference. Identifier
INV-0270	0..1	Reconciliation Reference ID	The unique identifier of the payment instruction, such as assigned by an instructing party for an instructed party to unambiguously identify the instruction.	Added during CEFACT Forum Rome 22-Apr-2009, requested by TBG 5	Header_ Trade Settlement. Payment Reference. Text
INV-0272	0..*	Payable Accounting Account	A payable accounting account specified for this trade settlement.	Added during CEFACT Forum Rome 22-Apr-2009, in agreement with TBG 12	Header_ Trade Settlement. Payable_ Specified. Trade_ Accounting Account

UID	Crđ	Short Name	Business Requirement	Rationale / Example / Mapping Notes / Status	Mapping to Dictionary Entry Name
INV-0273	0..*	Receivable Accounting Account	A receivable accounting account specified for this trade settlement.	Added during CEFACT Forum Rome 22-Apr-2009, in agreement with TBG 12	Header_ Trade Settlement. Receivable_ Specified. Trade_ Accounting Account
INV-0274	0..*	Purchase Accounting Account	A purchase accounting account specified for this trade settlement.	Added during CEFACT Forum Rome 22-Apr-2009, in agreement with TBG 12	Header_ Trade Settlement. Purchase_ Specified. Trade_ Accounting Account
INV-0275	0..*	Sales Accounting Account	A sales accounting account specified for this trade settlement.	Added during CEFACT Forum Rome 22-Apr-2009, in agreement with TBG 12	Header_ Trade Settlement. Sales_ Specified. Trade_ Accounting Account
INV-0281	0..1	Factoring Agreement	Reference to a underlying factoring agreement between invoice seller and factoring service provider.	Added during CEFACT Forum Rome 22-Apr-2009, in agreement with TBG 5. Details see CSC-REF	Header_ Trade Settlement. Factoring Agreement. Referenced_ Document
INV-0282	0..1	Factoring List	Reference to a factoring transmission list. This list contains identification information of factored invoices.	Added during CEFACT Forum Rome 22-Apr-2009, in agreement with TBG 5 Details see CSC-REF	Header_ Trade Settlement. Factoring List. Referenced_ Document
INV-0293	0..*	Financial Card Details	Details to a financial card related to this trade settlement.	Requirements reflected by CSCFCA in Common BRS. Added during CEFACT Forum Rome 22-Apr-2009, in agreement with TBG 5	Header_ Trade Settlement. Specified. Trade Settlement_ Financial Card
Line Section					Supply Chain_ Trade Line Item. Details
Grouping of Document Line Details					

UID	Crđ	Short Name	Business Requirement	Rationale / Example / Mapping Notes / Status	Mapping to Dictionary Entry Name
INV-0112	0..1	Invoice line number	The unique reference given by the issuer to identify an invoice line within an invoice		Document Line_ Document. Line. Identifier
INV-0113	0..1	Invoice line status code	The code specifying the status of this document line.		Document Line_ Document. Line Status. Code
INV-0114	0..1	Invoice line status reason code	The code specifying the reason for the status of this document line.		Document Line_ Document. Line Status Reason. Code
INV-0115	0..*	Invoice line note	The free text information related to the invoice line.		Document Line_ Document. Included. Note
INV-0116	0..1	Invoice parent line reference	Reference to the parent line, used in order to provide sublines of the line item.	Added in 10A.	Document Line_ Document. Parent_ Line. Identifier
INV-0295	0..1	Line item description code	A code specifying the type of trade item e.g., invoicing unit, consumer unit etc.	Added in 16A1	Supply Chain_ Trade Line Item. Description. Code
INV-0296	0..*	Sub-Line Item	A collection of information specific for a line breakdown (a constituent part of a product).	Added in 12B.	Subordinate_ Trade Line Item. Details
INV-0297	0..*	Sub-Line Item Price	A product price specified in the sub line trade agreement details.	Added in 12B;	Subordinate Line_ Trade Agreement. Gross Price_ Product. Trade_ Price / Subordinate Line_ Trade Agreement. Net Price_ Product. Trade_ Price / Subordinate Line_ Trade Agreement. List_ Product.

UID	Crđ	Short Name	Business Requirement	Rationale / Example / Mapping Notes / Status	Mapping to Dictionary Entry Name
					Trade_Price
INV-0298	0..*	Sub-Line Item agreement reference.	A document referenced in the sub-line trade agreement details.	Added in 12B.	Subordinate Line_Trade Agreement. Additional. Referenced_Document
INV-0299	0..1	Sub-Line Item package quantity.	The number of packages for this the sub-line item.	Added in 12B.	Subordinate Line_Trade Delivery. Package. Quantity
INV-0300	0..1	Sub-Line Item product unit quantity	The number of product units for this sub-line item.	Added in 12B.	Subordinate Line_Trade Delivery. Product_Unit. Quantity
INV-0301	0..1	Sub-Line Item per package unit quantity	The number of units per package for this sub-line item.	Added in 12B.	Subordinate Line_Trade Delivery. Per Package_Unit. Quantity
INV-0302	0..*	Sub-Line Item packaging	Packaging for this sub-line item.	Added in 12B.	Subordinate Line_Trade Delivery. Included. Supply Chain_Packaging
INV-0303	0..1	Sub-Line Item applicable tax	The trade tax applicable to this sub-line item.	Added in 12B.	Subordinate Line_Trade Settlement. Applicable. Trade_Tax
INV-0304	0..1	Sub-Line Item seller	The item seller party, such as an auction item seller, specified for this sub-line item.	Added in 12B.	Subordinate Line_Trade Agreement. Item_Seller. Trade_Party
INV-0305	0..1	Sub-Line Item buyer	The item buyer party, such as an auction item buyer, specified for this sub-line item.	Added in 12B.	Subordinate Line_Trade Agreement. Item_Buyer.

UID	Crđ	Short Name	Business Requirement	Rationale / Example / Mapping Notes / Status	Mapping to Dictionary Entry Name
					Trade_Party
INV-0306	0..1	Sub-Line Item marketplace	The marketplace included for this sub-line item.	Added in 12B.	Subordinate Line_Trade Agreement. Included. Specified_Marketplace
Grouping of Line Trade Agreement Details					
INV-0117	0..1	Seller Order document	Reference to seller order document (reference, issue date, involved parties, line number etc.)	Details see CSC-REF	Line_Trade Agreement. Seller Order. Referenced_Document
INV-0118	0..1	Buyer order document	Reference to order document (reference, issue date, involved parties, line number etc.)	Details see CSC-REF	Line_Trade Agreement. Buyer Order. Referenced_Document
INV-0119	0..1	Quotation document	Reference to quotation document (reference, issue date, involved parties, line number etc.)	Details see CSC-REF	Line_Trade Agreement. Quotation. Referenced_Document
INV-0120	0..1	Contract document	Reference to contract or agreement document (reference, issue date, involved parties, line number etc.)	Details see CSC-REF	Line_Trade Agreement. Contract. Referenced_Document
INV-0121	0..1	Demand forecast document	Reference to demand forecast document (reference, issue date, involved parties, line number etc.)	Details see CSC-REF	Line_Trade Agreement. Demand Forecast. Referenced_Document
INV-0292	0..*	Requisitioner reference	The requisitioner document referenced in this supply chain trade agreement.	Added during CEFACT Forum Rome by TBG1, 22-Apr-2009 Details see CSC-REF	Line_Trade Agreement. Requisitioner. Referenced_Document
INV-0123	0..*	Additional document reference	Reference to an additional document (reference, issue date, involved	Details see CSC-REF	Line_Trade Delivery. Additional. Referenced_Document

UID	Crđ	Short Name	Business Requirement	Rationale / Example / Mapping Notes / Status	Mapping to Dictionary Entry Name
			parties, etc.)		
INV-0124	0..1	Additional document type	A code specifying a type of additional document [Reference United Nations Code List (UNCL) 1153].		Referenced_Document. Reference_Type. Code
INV-0125	0..1	End consumer order number	Indication of the ultimate consignee order number	Renamed from Ultimate Consignee Order number to End consumer order number, covered with additional document.	Header_Trade Agreement. Additional_Associated. Referenced_Document
INV-0126	0..1	Delivery terms	The entity contains the details of the delivery terms and the place if relevant for the delivery terms.		Line_Trade Agreement. Applicable. Trade_Delivery Terms
INV-0127	0..1	Purchase Conditions	Reference to purchase conditions		Header_Trade Agreement. Additional. Referenced_Document
INV-0128	0..*	Price details for gross price	including price amount, price type, base quantity, validity period, free of charge indicator etc.	Further details see Common BRS (CSC-PRI)	Line_Trade Agreement. Gross Price_Product. Trade_Price
INV-0129	0..*	Price details for net price	including price amount, price type, base quantity, validity period, free of charge indicator etc.	Further details see Common BRS (CSC-PRI)	Line_Trade Agreement. Net Price_Product. Trade_Price
INV-0290	0..*	Requisitioner	A trade party who is a buyer requisitioner in this trade agreement.	Added during CEFACT Forum Rome by TBG1, 22-Apr-2009 Details see CSC-PAR	Line_Trade Agreement. Buyer_Requisitioner. Trade_Party
INV-0307	0..1	Marketplace	An actual or nominal place where buyers and sellers interact (directly or through intermediaries) to	Added in 12B.	Line_Trade Agreement. Included. Specified_Marketplace

UID	Crđ	Short Name	Business Requirement	Rationale / Example / Mapping Notes / Status	Mapping to Dictionary Entry Name
			trade goods or services.		
INV-0308	0..1	Item seller	The item seller party, such as an auction item seller, specified in this trade agreement.	Added in 12B	Line_Trade Agreement. Item_Seller. Trade_Party
INV-0309	0..1	Item buyer	The item buyer party, such as an auction item buyer, specified in this trade agreement.	Added in 12B	Line_Trade Agreement. Item_Buyer. Trade_Party
INV-0321	0..*	Customer Order reference	A customer order document referenced for this line trade agreement.	Postponed	
Grouping of Line Trade Delivery Details					
INV-0013	0..1	Despatched quantity	The quantity of the goods of the invoice line despatched by the supplier.		Header_Trade Delivery. Actual_Despatch. Supply Chain_Event / Supply Chain_Event. Unit. Quantity
INV-0134	0..1	Received quantity	The quantity received in this trade delivery.	Added to 16A.1	Line_Trade Delivery. Received. Quantity / Supply Chain_Event. Unit. Quantity
INV-0135	0..1	Billed quantity	The quantity billed for this trade delivery		Line_Trade Delivery. Billed. Quantity
INV-0136	0..1	Free goods quantity	The quantity of free goods in this trade delivery		Line_Trade Delivery. Charge Free. Quantity
INV-0137	0..1	Delivered quantity	The quantity of articles or services which has been delivered to the delivery party.		Header_Trade Delivery. Actual_Delivery. Supply Chain_Event / Supply Chain_

UID	Crđ	Short Name	Business Requirement	Rationale / Example / Mapping Notes / Status	Mapping to Dictionary Entry Name
					Event. Unit. Quantity
INV-0138	0..1	Returned quantity	The quantity of articles returned by the delivery party or receiving party to the shipper.	Postponed to 16B.	Line_ Trade Delivery. Due In_ Returned. Quantity
INV-0139	0..1	Quantity per pack	The quantity contained in the currently identified pack.		Line_ Trade Delivery. Per Package_ Unit. Quantity
INV-0140	0..1	Number of consumer	The number of consumer units (package size of a product agreed between trading partners as the unit crossing the retail point of sale) in a traded unit to be ordered, delivered and invoiced.		Line_ Trade Delivery. Product_ Unit. Quantity
INV-0141	0..1	Number of units in higher packaging or configuration level	The number of units contained in higher packaging or configuration level.		Supply Chain_ Packaging. Details / Supply Chain_ Packaging. Level. Code
INV-0143	0..1	Delivery Adjustment	Adjustment to the delivery.		Line_ Trade Delivery. Specified. Delivery_ Adjustment
INV-0144	0..1	Gross weight	The weight of the goods including packing but excluding the carriers' equipment of the invoice line.		Line_ Trade Delivery. Gross Weight. Measure
INV-0145	0..1	Net weight	The weight of the goods themselves without any packing. (net weight) of the invoice line		Line_ Trade Delivery. Net Weight. Measure
INV-0146	0..1	Theoretical weight	The calculated weight of the goods of the invoice based on the dimensions		Line_ Trade Delivery. Theoretical Weight.

UID	Crđ	Short Name	Business Requirement	Rationale / Example / Mapping Notes / Status	Mapping to Dictionary Entry Name
			ordered.		Measure
INV-0147	0..1	Consignor party	Party which, by contract with a carrier, consigns or sends goods with the carrier, or has them conveyed by him. Synonym: shipper, sender.	Details see CSC-PAR	Supply Chain_ Consignment. Consignor. Trade_ Party
INV-0148	0..1	Consignee party	Party to which goods are consigned.	Details see CSC-PAR	Supply Chain_ Consignment. Consignee. Trade_ Party
INV-0150	0..1	Number of packages	The total number of packages comprising an invoice line.		Line_ Trade Delivery. Package. Quantity
INV-0151	0..1	Type of package	Specifying the type of package, e.g., box. Carton etc.	DE 7065	Supply Chain_ Packaging. Type. Code
INV-0152	0..1	Mode of package	Description of the form in which goods are presented.		Supply Chain_ Packaging. Description. Text
INV-0153	0..1	Transport mode	The code specifying the mode of transport.		Logistics_ Transport Movement. Mode. Text
INV-0154	0..1	Transport means	The entity contains the identification of the means of transport (e.g., license plate of the lorry, wagon number, name of the vessel).		Logistics_ Transport Means. Identification. Identifier
INV-0155	0..1	Marks and numbers	The information requested on the transport label of the package.		Packaging_ Marking. Content. Text Packaging_ Marking. Barcode_ Type. Code

UID	Crđ	Short Name	Business Requirement	Rationale / Example / Mapping Notes / Status	Mapping to Dictionary Entry Name
INV-0156	0..1	Transport charge amount	The amount including tax charged by shipper for moving goods, by whatever means, from one place to another.		Line_ Trade Settlement. Specified. Logistics_ Service Charge / Logistics_ Service Charge. Applied. Amount
INV-0157	0..1	Taxable transport charge amount	The amount before tax charged by shipper for moving goods, by whatever means, from one place to another.		Logistics_ Service Charge. Applied. Trade_ Tax
INV-0158	0..1	Insurance charge amount	The amount of premium payable to the insurance company to insure the goods.	Added in 16A.1	Supply Chain_ Consignment. Insurance Premium. Amount
INV-0159	0..1	Ship to party	The party where the goods were delivered or where the service was completed.	Details see CSC-PAR	Line_ Trade Delivery. Ship To. Trade_ Party
INV-0160	0..1	Ship from party	Party where goods are shipped from.	Details see CSC-PAR	Line_ Trade Delivery. Ship From. Trade_ Party
INV-0161	0..1	Pick up place	Party/Place where goods were picked up by the buyer or his representative	Details see CSC-PAR	Line_ Trade Delivery. Actual_ Pick-Up. Supply Chain_ Event
INV-0162	0..1	Despatch advice document	Reference to despatch advice document (reference, issue date, involved parties, line number etc.)	Details see CSC-REF	Line_ Trade Delivery. Despatch Advice. Referenced_ Document
INV-0163	0..1	Ultimate Consignee	Party who has been designated on the invoice or packing list as the final recipient of the stated merchandise.	Used in cross-docking scenarios Details see CSC-PAR	Supply Chain_ Consignment. Consignee. Trade_ Party
INV-0164	0..1	Ultimate Customer	End customer, the final recipient of goods or services.	e.g., to identify the end consumer	Header_ Trade Delivery. Ultimate_ Ship

UID	Crđ	Short Name	Business Requirement	Rationale / Example / Mapping Notes / Status	Mapping to Dictionary Entry Name
				Mapping into Ultimate_ShipTo. Same mapping applies for 0164 and 0163. Details see CSC-PAR	To. Trade_Party
INV-0165	0..*	Receiving advice document	Reference to receiving advice document (reference, issue date, involved parties, line number etc.)	Details see CSC-REF	Line_Trade Delivery. Receiving Advice. Referenced_Document
INV-0166	0..*	Additional document reference	Reference to an additional document (reference, issue date, involved parties, etc.)	Details see CSC-REF	Line_Trade Delivery. Additional. Referenced_Document
INV-0167	0..*	Additional document type	A code specifying a type of additional document [Reference United Nations Code List (UNCL) 1153].		Referenced_Document. Reference_Type. Code
INV-0168	0..1	Delivery note document	Reference to delivery note document (reference, issue date, involved parties, line number etc.)	Details see CSC-REF	Line_Trade Delivery. Delivery Note. Referenced_Document
INV-0169	0..1	Packing list document	Reference to packing list document (reference, issue date, involved parties, line number etc.)	Details see CSC-REF Added in 16A.1	Line_Trade Delivery. Packing List. Referenced_Document
INV-0170	0..1	Delivery date/period	A date, time, date time, or other date time value of an occurrence of this event.	Also applicable for service completion date. Includes also the indication of delivery periods.	Line_Trade Delivery. Actual_Delivery. Supply Chain_Event / Supply Chain_Event. Occurrence. Specified_Period

UID	Crđ	Short Name	Business Requirement	Rationale / Example / Mapping Notes / Status	Mapping to Dictionary Entry Name
INV-0171	0..1	Despatch Date	Date/time on which the ordered goods or services were dispatched.		Line_Trade Delivery. Actual_Despatch. Supply Chain_Event / Supply Chain_Event. Occurrence. Date Time
INV-0172	0..1	Pick up date	Date/time on which the ordered goods were picked up.		Line_Trade Delivery. Actual_Pick-Up. Supply Chain_Event / Supply Chain_Event. Occurrence. Date Time
INV-0173	0..1	Requested Delivery Date	Date on which buyer requests goods or services to be delivered.	e.g., for calculation of penalties	Line_Trade Delivery. Requested_Delivery. Supply Chain_Event / Supply Chain_Event. Occurrence. Date Time
INV-0174	0..1	Receiving Date	Date/time of receipt.		Line_Trade Delivery. Actual_Receipt. Supply Chain_Event / Supply Chain_Event. Occurrence. Date Time
INV-0310	0..1	Consignment item tariff quantity	The tariff quantity specified for this consignment item.	Added in 12B.	Supply Chain_Consignment Item. Tariff. Quantity
Grouping of Line Trade Settlement Details					
INV-0175	0..1	Invoice line item amount	The monetary amount of the invoice line, without all allowances and charges related to the invoice line and before tax or fee.		Trade Settlement Line_Monetary Summation. Line Total. Amount

UID	Crđ	Short Name	Business Requirement	Rationale / Example / Mapping Notes / Status	Mapping to Dictionary Entry Name
INV-0176	0..1	Invoice line item amount without tax	The monetary value that constitutes the line total without tax. This total is the total of items plus total of allowance/charges.	If the price given is a gross price, the Item Amount is calculated = (Quantity * Unit Gross Price) + Charges – Allowances. If applicable, allowances and charges must be provided. If the price given is a net price, the Item Amount is calculated = Quantity * Unit Net Price.	Trade Settlement Line_Monetary Summation. Net_Line Total. Amount
INV-0177	0..1	Invoice line item total amount	The total amount of the invoice line, being the sum of Invoice line item amount, Invoice item allowances/charges amounts and tax/fee amount.		Trade Settlement Line_Monetary Summation. Line Total. Amount
INV-0178	0..1	Allowance and / or charge line total amount of the line item	The monetary value that constitutes the allowance charge line total on which the trade settlement is calculated.		Line_Trade Settlement. Specified. Trade_Allowance Charge
INV-0179	0..1	Information amount	Additional amount for information: e.g., shrink amount for vegetables, amount without tobacco tax etc.		Trade Settlement Line_Monetary Summation. Information. Amount
INV-0180	0..1	Invoice document	An invoice reference number. The invoice being referred to is a previously sent invoice.	Details see CSC-REF	Line_Trade Settlement. Invoice. Referenced_Document
INV-0255	0..*	Payment Terms	Specifying Payment terms for this document.	Added during TBG 1 review to align with Common BRS. Further details see Common BRS (CSC-PYT).	Line_Trade Settlement. Specified. Trade_Payment Terms

UID	Crđ	Short Name	Business Requirement	Rationale / Example / Mapping Notes / Status	Mapping to Dictionary Entry Name
INV-0187	0..1	Payment adjustment reason code	A code specifying a reason for the adjustment.		Financial_ Adjustment. Reason. Code
INV-0188	0..1	Payment adjustment reason text	A reason, expressed as text, for the adjustment.		Financial_ Adjustment. Reason. Text
INV-0189	0..1	Payment adjustment actual amount	The actual monetary amount added or subtracted as a result of this adjustment.	Added in 16A.1	Line_ Trade Settlement. Total_ Adjustment. Amount
INV-0190	0..1	Payment adjustment actual quantity	The actual quantity for the Adjustment		Financial_ Adjustment. Actual. Quantity
INV-0191	0..1	Payment adjustment actual date time	The actual date, time, date time, or other date time value for the Adjustment		Financial_ Adjustment. Actual. Date Time
INV-0195	0..1	Indicator not subject to discount	The item concerned is not applicable for discount calculation.	Added in 16A.1	Line_ Trade Settlement. Discount. Indicator
INV-0196	0..*	Allowance and/or charge details	Details regarding allowances and charges	Further details see Common BRS (CSC-ALC)	Line_ Trade Settlement. Specified. Trade_ Allowance Charge
INV-0197	0..*	Allowance and/or charge rate	Rate per unit which the allowance or charge applies, e.g., the allowance/charge amount is 3 EUR per 10 tons.	Added in 09A.	Line_ Trade Settlement. Specified. Trade_ Allowance Charge. Calculation. Percent
INV-0198	0..*	Allowance and/or charge rate basis	Basis for the rate per unit which the allowance or charge applies, e.g., the allowance/charge amount is 3 EUR per 10 tons.	Added in 09A.	Line_ Trade Settlement. Specified. Trade_ Allowance Charge. Basis. Amount / Header_ Trade Settlement. Specified.

UID	Crđ	Short Name	Business Requirement	Rationale / Example / Mapping Notes / Status	Mapping to Dictionary Entry Name
					Trade_ Allowance Charge. Unit_ Basis. Amount
INV-0199	0..*	Freight Charge	Charge for freight	If not included in allowances and charges	Line_ Trade Settlement. Specified. Logistics_ Service Charge
INV-0200	0..*	Total tax basis amount of the line item	The monetary value that constitutes the total tax basis on which the trade settlement is calculated.		Trade Settlement Line_ Monetary Summation. Tax Basis Total. Amount
INV-0201	0..*	Tax line total amount of the line item	The monetary value that constitutes the tax line total on which the trade settlement is calculated.		Trade Settlement Line_ Monetary Summation. Tax Total. Amount
INV-0202	0..*	Applicable Tax	A levy or payment for the support of a government required of persons, groups, or businesses within the domain of that government.	Further details see Common BRS (CSC-TAX) Note: Includes Place of Supply	Line_ Trade Settlement. Applicable. Trade_ Tax
INV-0259	0..*	Calculated Tax	The calculated tax for the invoice	Added in TBG 1 review. Further details see Common BRS (CSC-TAX)	Line_ Trade Settlement. Subtotal_ Calculated. Trade_ Tax
INV-0260	0..*	Tax scheme	Specifying the tax scheme	Added in TBG 1 review. Further details see Common BRS (CSC-TXS)	Trade_ Tax. Category. Code
INV-0276	0..*	Payable Accounting Account	A payable accounting account specified for this trade settlement.	Added during CEFACT Forum Rome 22-Apr-2009, in agreement with TBG 12	Line_ Trade Settlement. Payable_ Specified. Trade_ Accounting Account
INV-0277	0..*	Receivable Accounting Account	A receivable accounting account specified for this	Added during CEFACT Forum Rome 22-Apr-	Line_ Trade Settlement. Receivable_

UID	Crđ	Short Name	Business Requirement	Rationale / Example / Mapping Notes / Status	Mapping to Dictionary Entry Name
			trade settlement.	2009, in agreement with TBG 12	Specified. Trade_Accounting Account
INV-0278	0..*	Purchase Accounting Account	A purchase accounting account specified for this trade settlement.	Added during CEFACT Forum Rome 22-Apr-2009, in agreement with TBG 12	Line_Trade Settlement. Purchase_Specified. Trade_Accounting Account
INV-0279	0..*	Sales Accounting Account	A sales accounting account specified for this trade settlement.	Added during CEFACT Forum Rome 22-Apr-2009, in agreement with TBG 12	Line_Trade Settlement. Sales_Specified. Trade_Accounting Account
INV-0294	0..1	Financial Card Details	Details to a financial card related to this trade settlement on line level.	Requirements reflected by CSCFCA in Common BRS. Added during CEFACT Forum Rome 22-Apr-2009, in agreement with TBG 5	Line_Trade Settlement. Specified. Trade Settlement_Financial Card
INV-312	0..1	Grand Total. Amoun	The monetary value of the grand total amount to this trade settlement on line level.	Added in 16A	Trade Settlement Line_Monetary Summation. Grand Total. Amount
Grouping of Product Details					
INV-0261	0..1	Product Details	Details regarding the product.	Further details see Common BRS (CSC-PRO including CSC-PIN)	Trade_Product. Details
INV-0318	0..*	Included Referenced Product	An included product referenced from this trade product.	Added in 16A.1	Trade_Product. Included. Referenced_Product
Valuation Breakdown Statement					
INV-0254	0..*	Valuation Breakdown Statement	Used for describing, asserting or approving the works performed and invoiced in specific sectors.	Realization CCL 09B.1 as requested by TBG 6.	Valuation_Breakdown Statement. Details

UID	Crd	Short Name	Business Requirement	Rationale / Example / Mapping Notes / Status	Mapping to Dictionary Entry Name
			Used alternatively to the Line Section of an invoice.		

172
173

174
175 **2.4 Business Processes, Information Envelopes and Authorised Roles**

176 The BRS Cross Industry Invoice defines the following processes:

- 177 - Traditional or supplier initiated invoice
- 178 - Incorrect invoice
- 179 - Self-billing invoice
- 180 - Self-billing incorrect invoice

182 **2.5 Business Partner Types and Authorised Roles**

- 183 - Seller
- 184 - Buyer

185 **Table 1-1: Business Partner Types and Authorized Roles**

Authorised Role Name	Business Partner Type Name
Invoice Issuer	Seller Organization Buyer Organization (self-billing)
Invoice Sender	Seller Organization Buyer Organization (self-billing)
Invoice Receiver	Seller Organization (self-billing) Buyer Organization

187 **2.5.1 Conceptual Model**

188 The conceptual model identifies the main Entity Classes. The following model is shown in the form
189 of class diagram.

190 **Figure 2.5.1. Cross Industry Invoice conceptual data model**

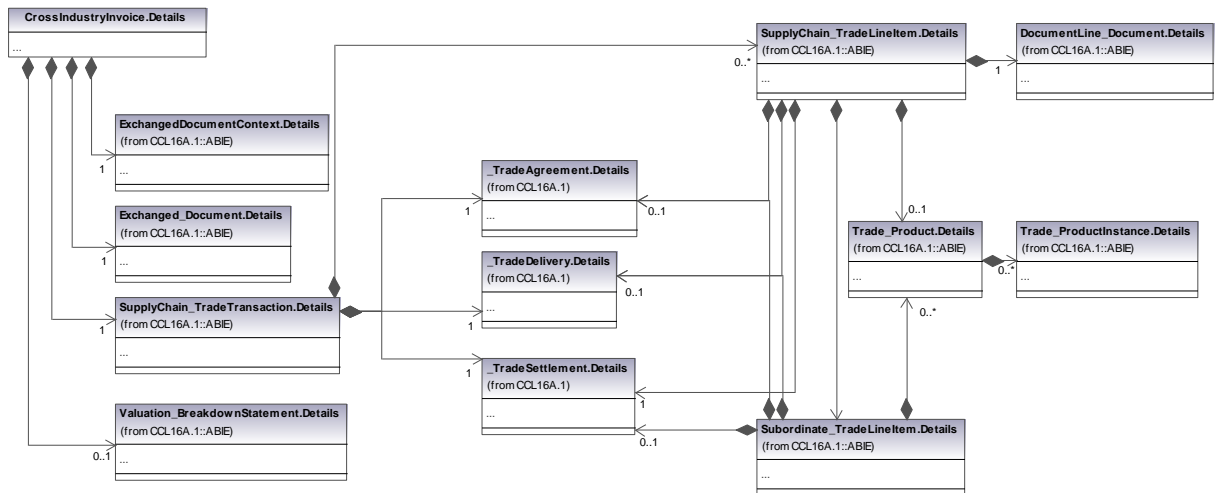

191
192 *Note: For simplification purposes the associations TradeAgreement, TradeDelivery, TradeSettlement for*
193 *SupplyChainTransaction are qualified with 'Header' and for SupplyChainTradeLineItem are qualified with 'Line' and for*
194 *SubordinateTradeLineItem are qualified with 'Subordinate Line'*

195 **Philosophy behind the conceptual design**

196
197 The conceptual design is based on the assumption that information exchanged in the order-to-pay
198 process tends to have a large degree of similarity. Therefore, rather than linking the information to
199 message specific entities three neutral entities have been defined: Trade Agreement, Trade
200 Delivery and Trade Settlement. These entities contain the main semantic payload for all
201 communication exchanges, on header as well as on line level. A fourth essential entity is the

202 Product entity. This entity holds all characteristics of the trade product that are independent of a
203 particular trade transaction. The Trade Transaction and Trade Line Item entities serve to structure
204 the entities mentioned before.

205
206

Description of the main entities

207

Header section of an invoice.

208
209

1. Exchanged Document Context: Application processing information for the business document.

210
211

2. Exchanged Document: Generic document heading information such as Invoice number, Issue date.

212

3. Trade Transaction: Information on the trade transaction(s) to which the invoice applies.

213
214

4. Trade Agreement: information on the commercial agreement on which the invoiced trade transaction or line is based.

215

5. Trade Delivery: information on the fulfilment of the invoiced trade transaction or line.

216
217

6. Trade Settlement: information on the financial settlement of the invoiced trade transaction or line.

218

Line section of an invoice.

219

7. Trade Line Item: Information on the line items that are being invoiced.

220
221

8. Subordinate Trade Line Item: a collection of information specific for a line breakdown (sub-line: a constituent part of a product).

222
223

9. Valuation Breakdown Statement: information on asserting or approving the works performed and invoiced in specific sectors.

224

10. Product: Information on the generic object that is being invoiced.

225

11. Product Instance: Information on the individual objects that are being invoiced.

226

227

2.6 Information Mapping

228

2.6.1 Referenced CCL

229

CCL16A.1

230

Remark: Additions or changes to this CCL are included later in this section. During the harmonization process the change requests will be considered against the whole CCL and may lead to suggestions for the re-use or modification of existing core components.

231

232

233

2.6.2 Business Information Entity Model

234

For readability reasons the canonical model is provided in multiple diagrams, each providing a full description of a segment in the Cross Industry Invoice. Note: The three entities Trade Agreement, Trade Delivery and Trade Settlement have been depicted as identical on header and line level, since these entities are meant to support the entire Order-to-Pay process. In the individual steps of the process, such as the invoice, further refinements can be made on what is communicated on header and line level. Therefore, in the canonical model for the Invoice message the three conceptual entities are realized as six message specific entities, one for the header and one for the line.

235

236

237

238

239

240

241

242

243

244
245
246
247

Figure 2.6.2-01 Exchanged_ Document, Exchanged Document_ Context and Document Line_ Document

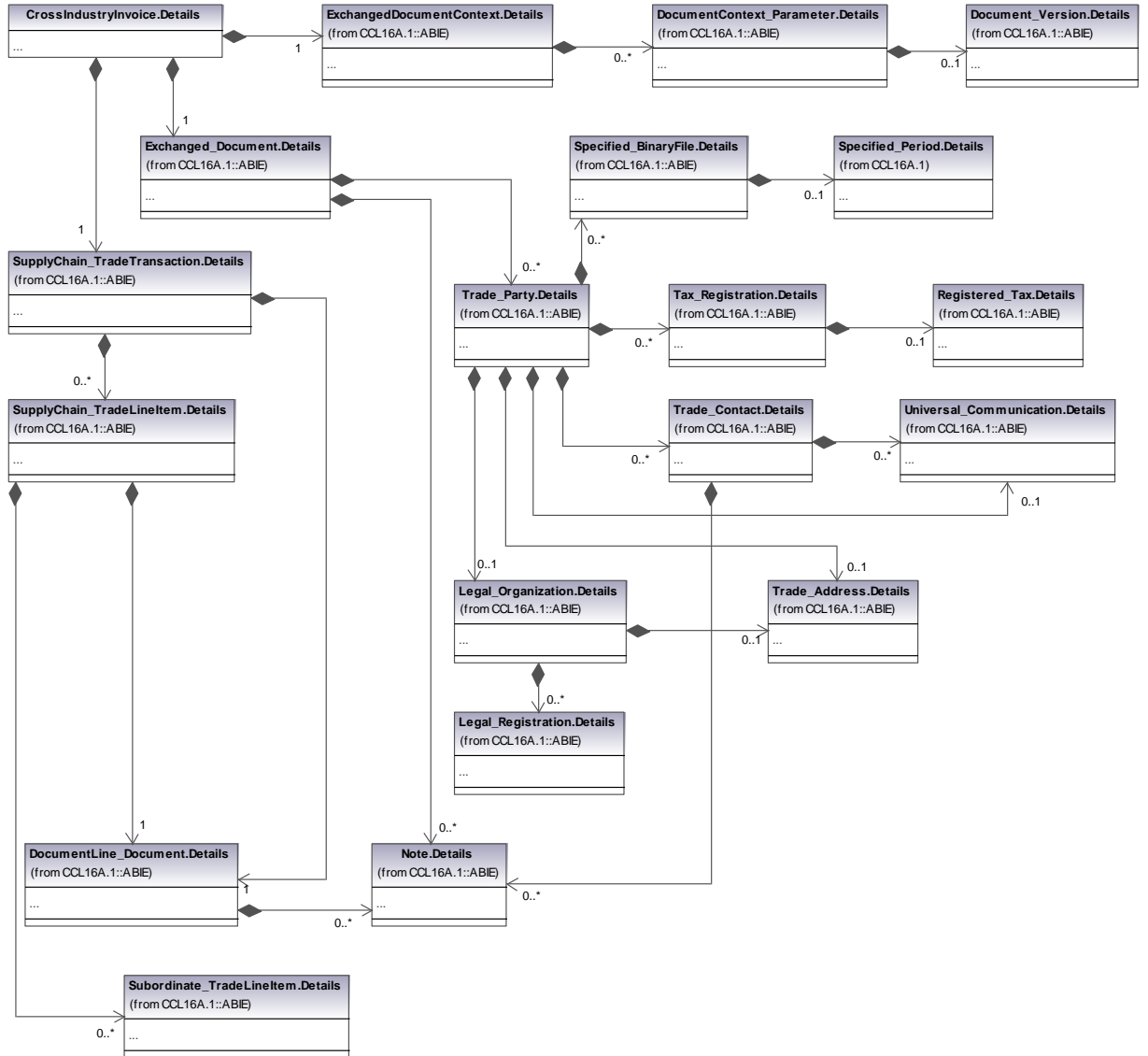

248
249
250

251
252
253

Figure 2.6.2-02 Header_ Trade Agreement

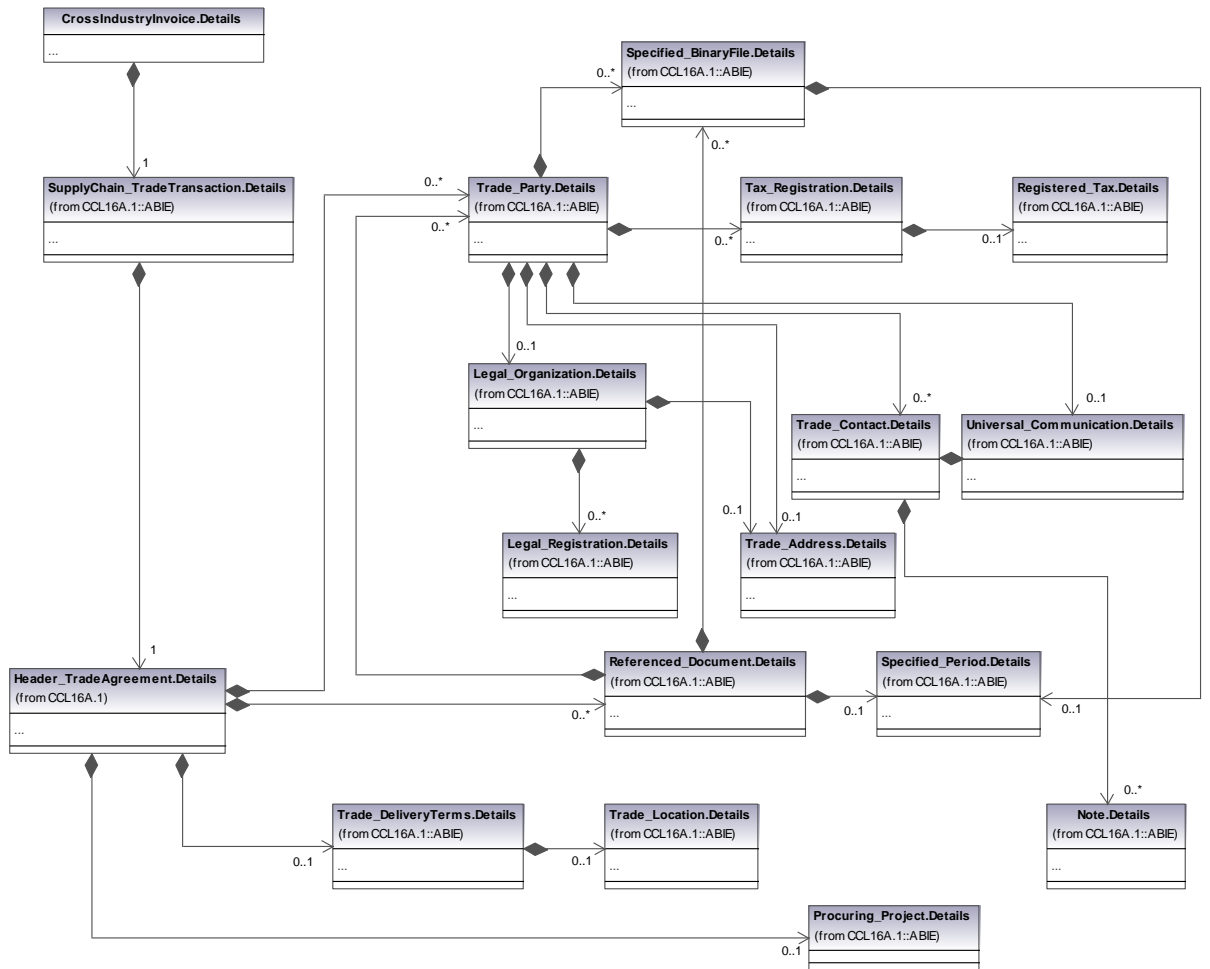

254
255
256
257
258
259
260
261
262
263
264
265
266
267
268

269
270
271

Figure 2.6.2-03 Line_ Trade Agreement

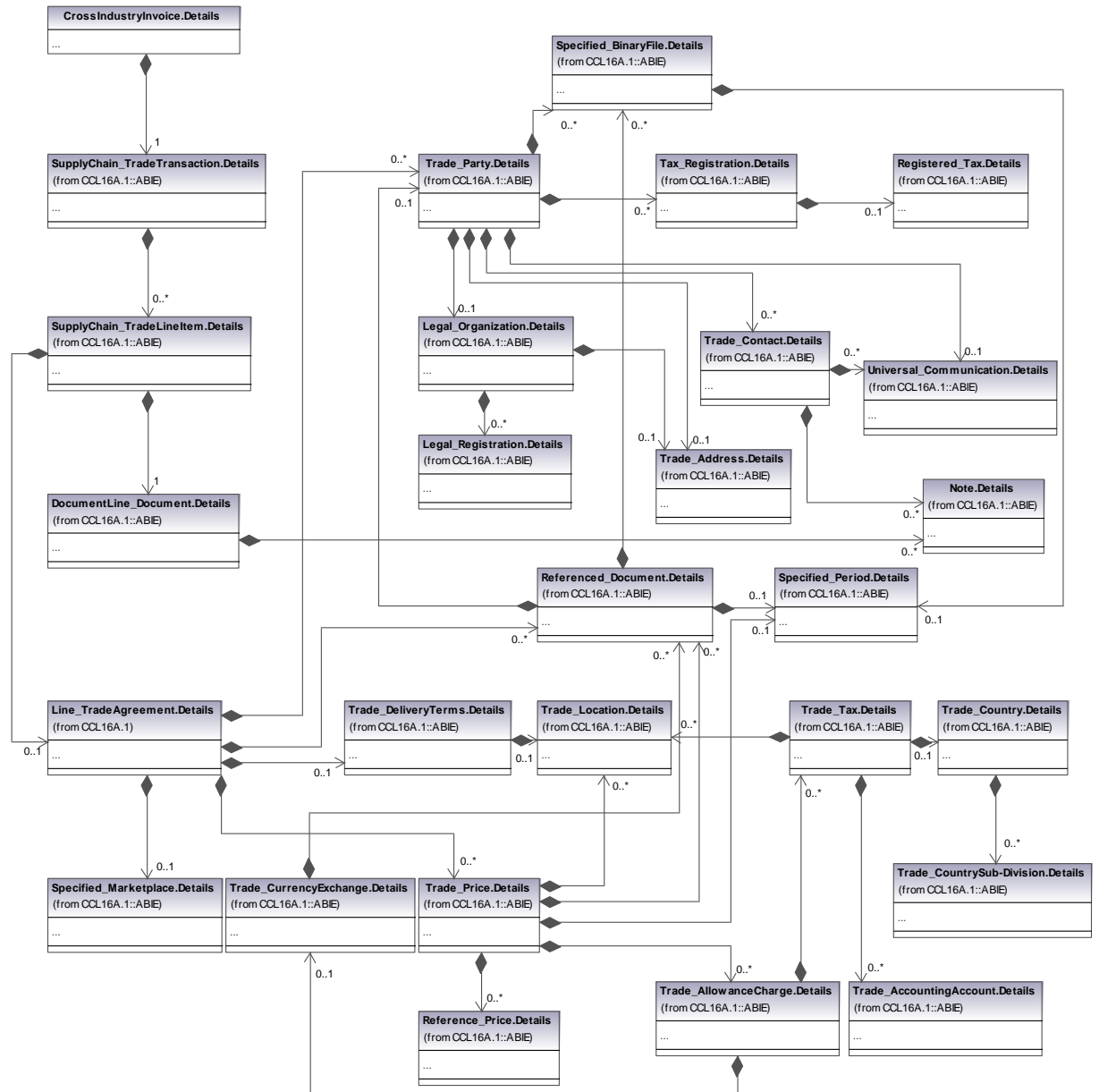

272
273
274
275
276
277
278
279
280

281
282
283

Figure 2.6.2-04 Header_ Trade Delivery

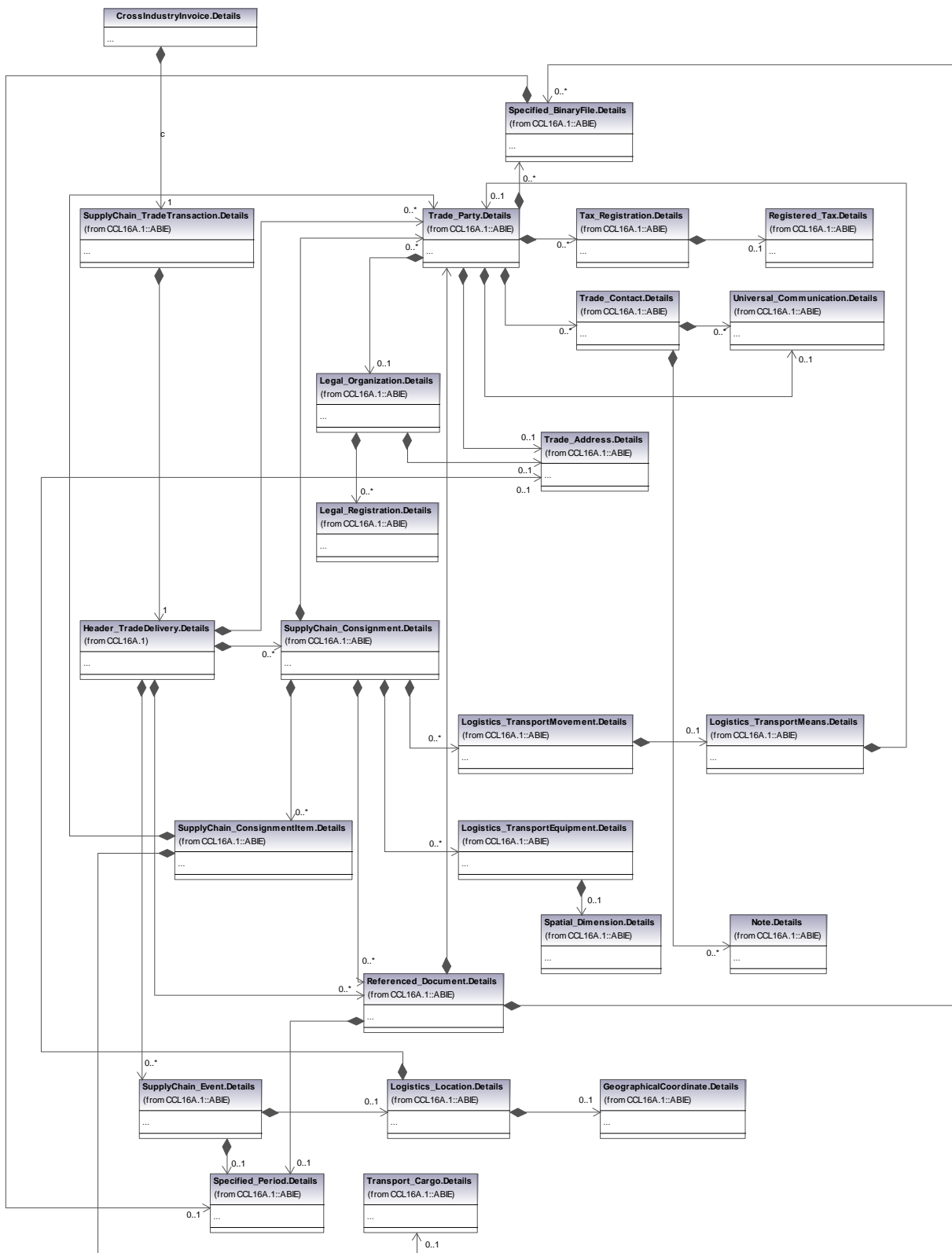

284

288
289

Figure 2.6.2-06 Header_ Trade Settlement

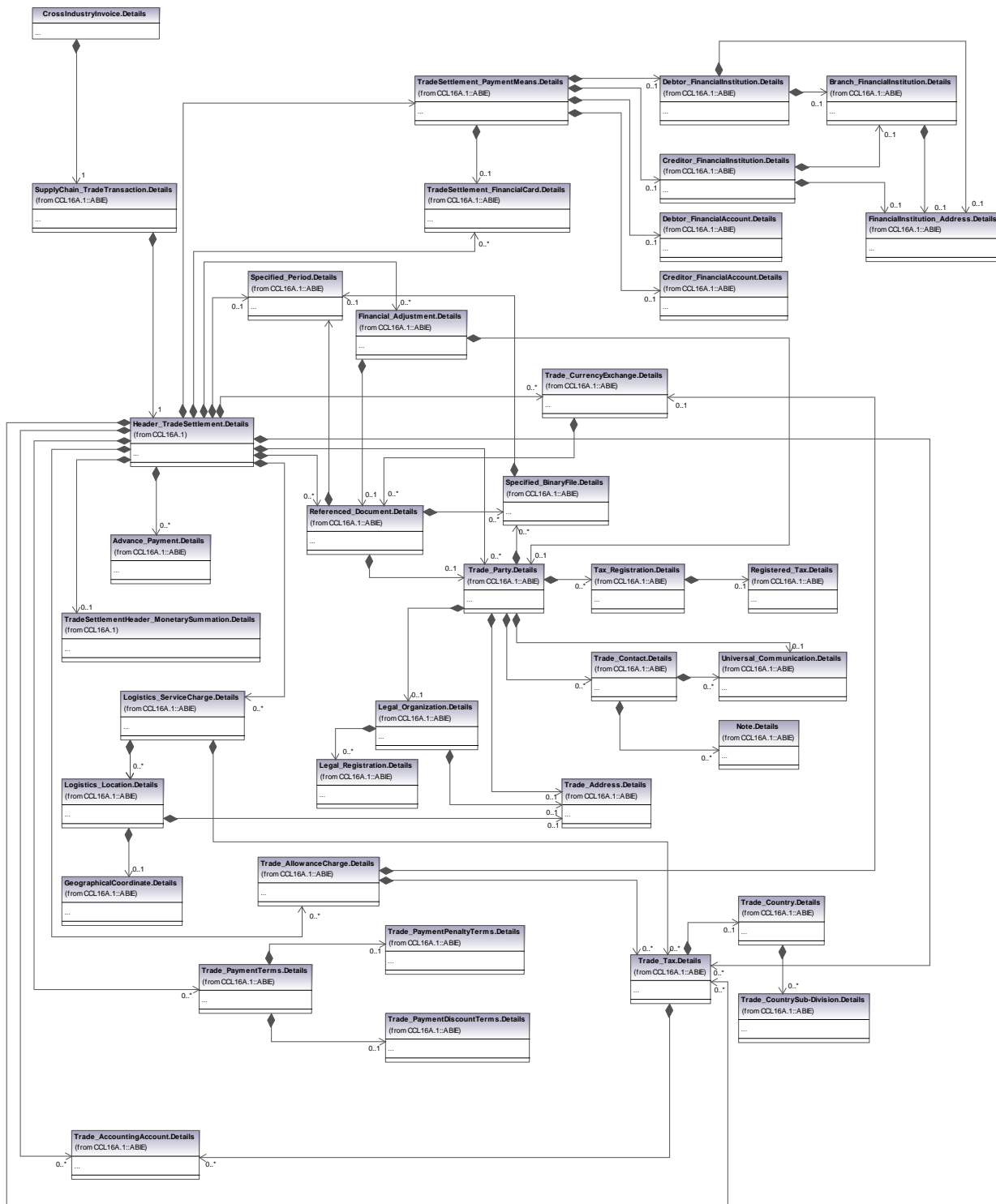

290
291
292
293
294

295
296

Figure 2.6.2-07 Line_Trade Settlement

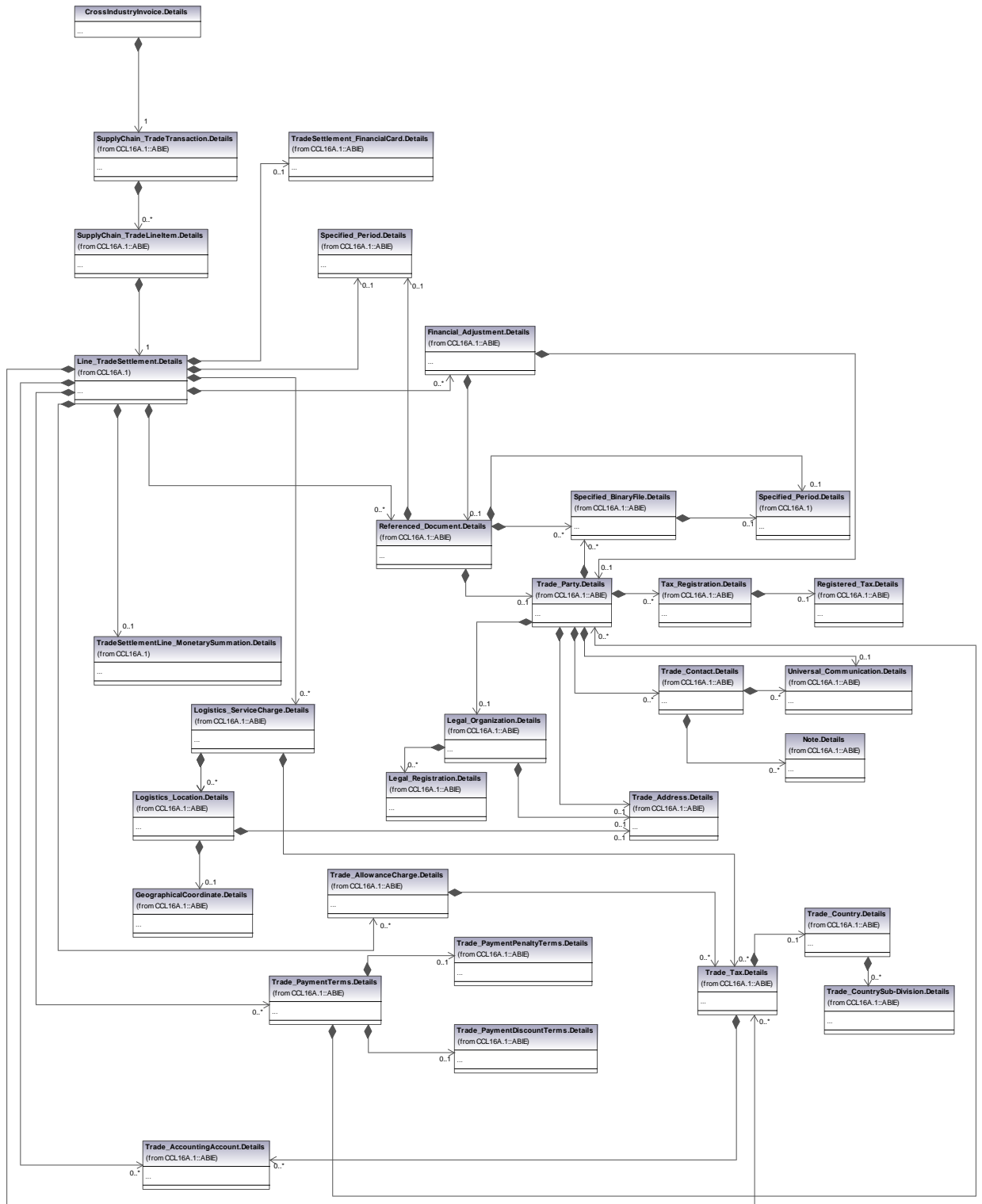

297
298
299

300
301

Figure 2.6.2-08 Trade_Product

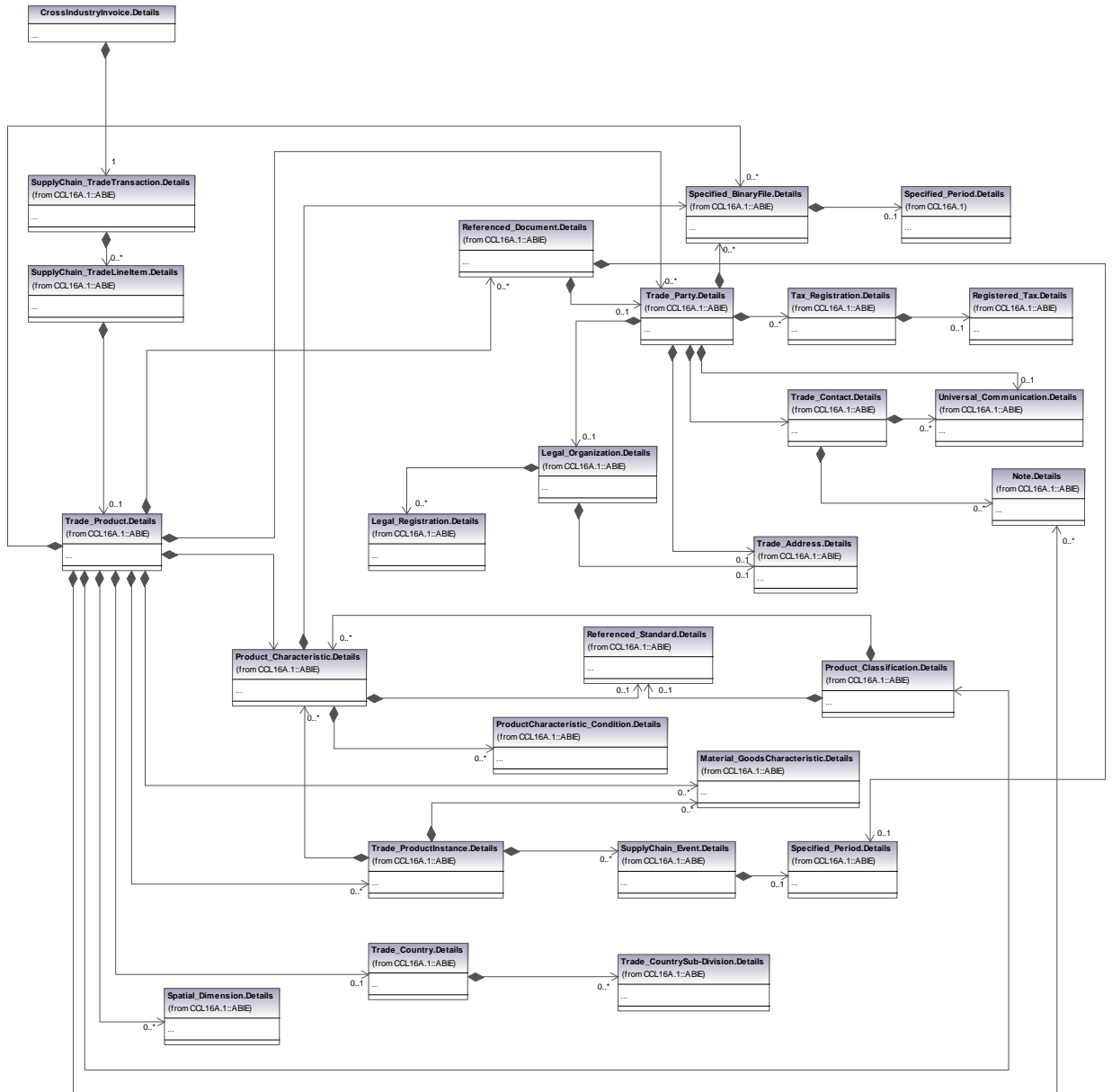

302
303
304
305
306
307
308
309
310
311
312

313

314

Figure 2.6.2-09 Valuation_ Breakdown Statement

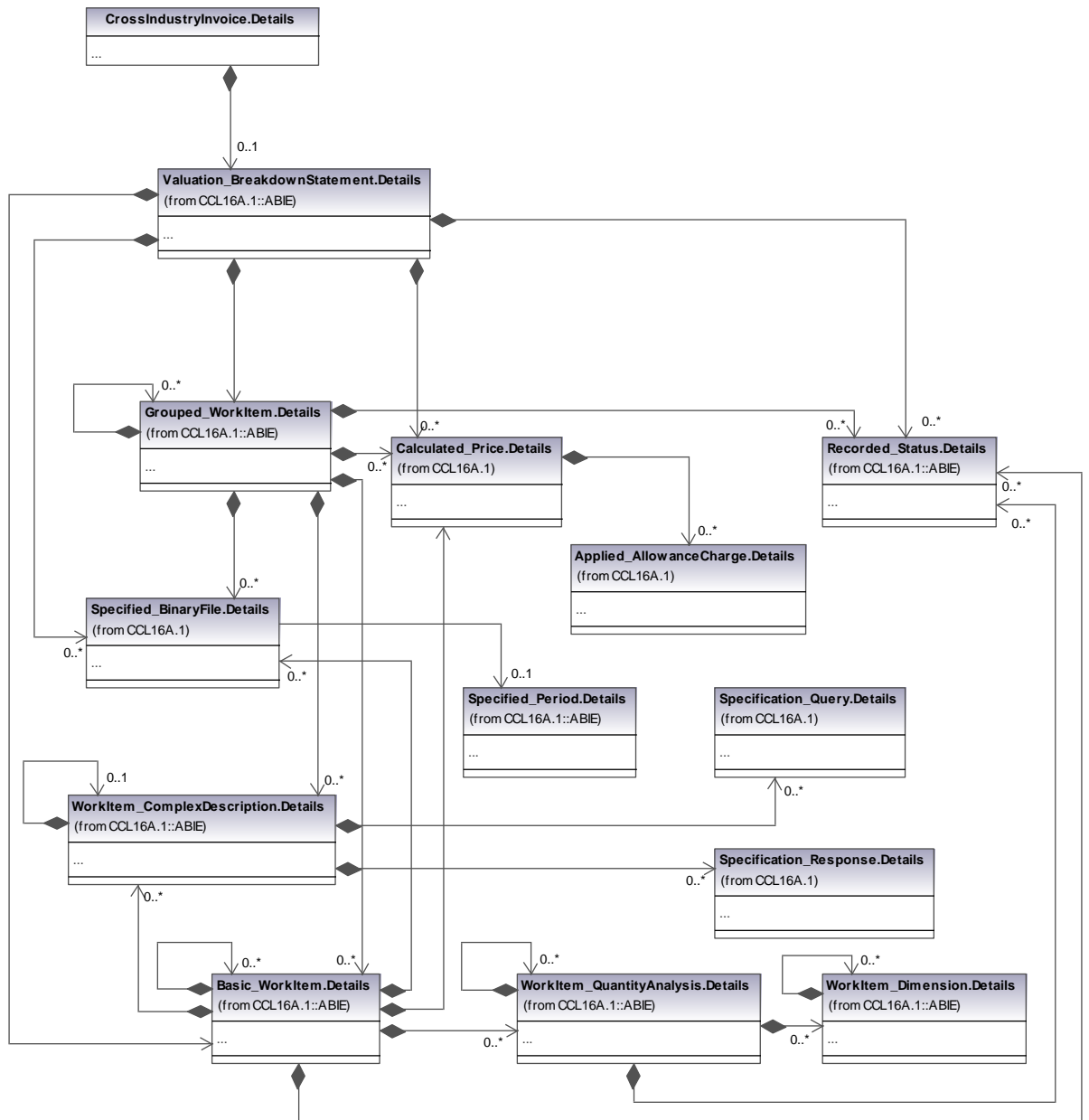

315

2.6.2.1 New and Changed Components

The new and changed components for the Cross Industry Invoice will be identified by the SCRDM (Supply Chain Reference Data Model) project.

2.6.2.2 Detailed class diagrams

Below diagrams are detailing the CCTS Business Information Entities (BIEs) identified as part of the Cross Industry Invoice. Compared to the canonical data model, as presented earlier, these multiple diagrams are broken down in a logical fashion. The Class Diagrams show the Aggregate Business Information Entity, and its properties (Basic Business Information Entities and its Association Business Information Entities), and relevant cardinalities.

Figure 2.6.2-10 Cross Industry Invoice (root element)

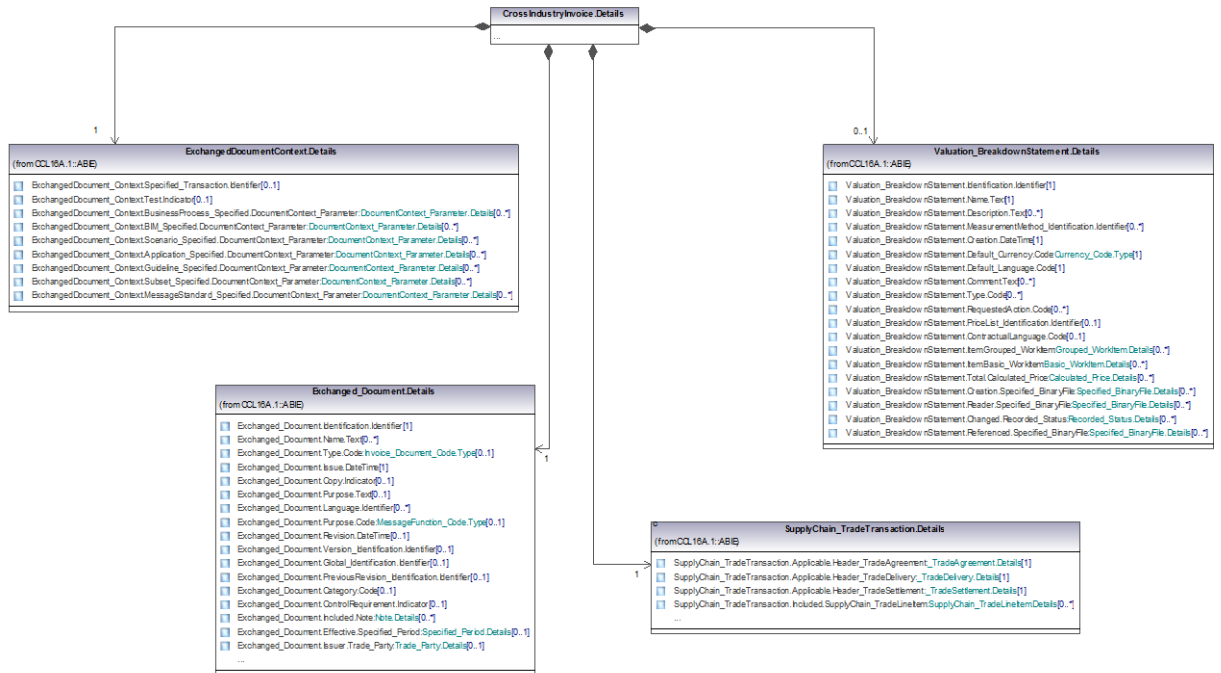

Figure 2.6.2-11 Trade Transaction

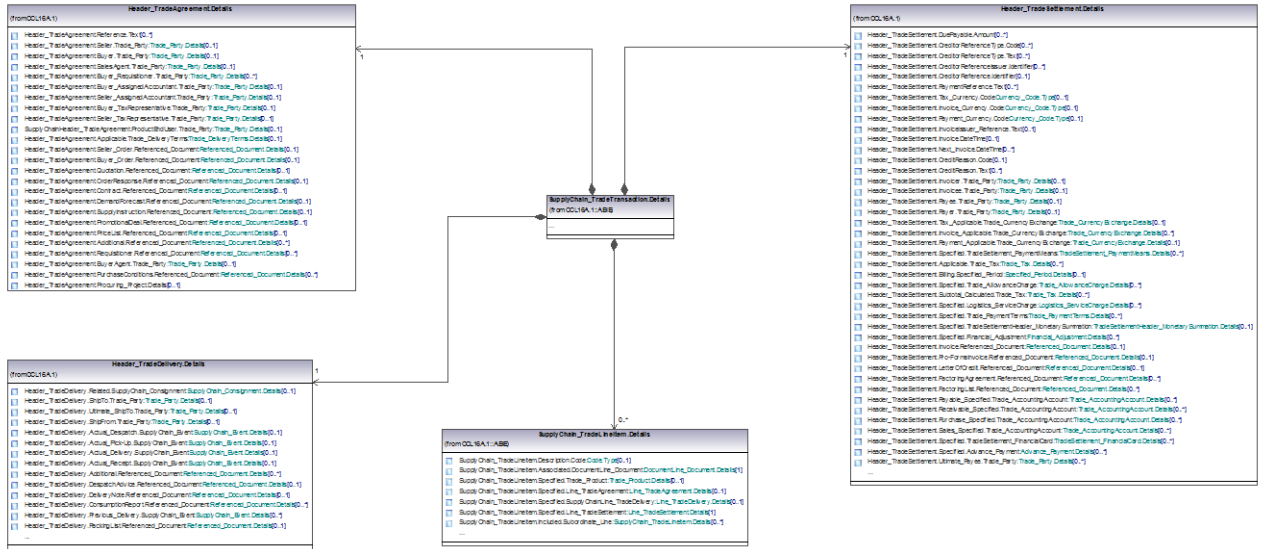

Figure 2.6.2-12 Trade Settlement Header_ Specified. Trade_ Allowance Charge



Figure 2.6.2-13 Trade Settlement Header_ Monetary Summation

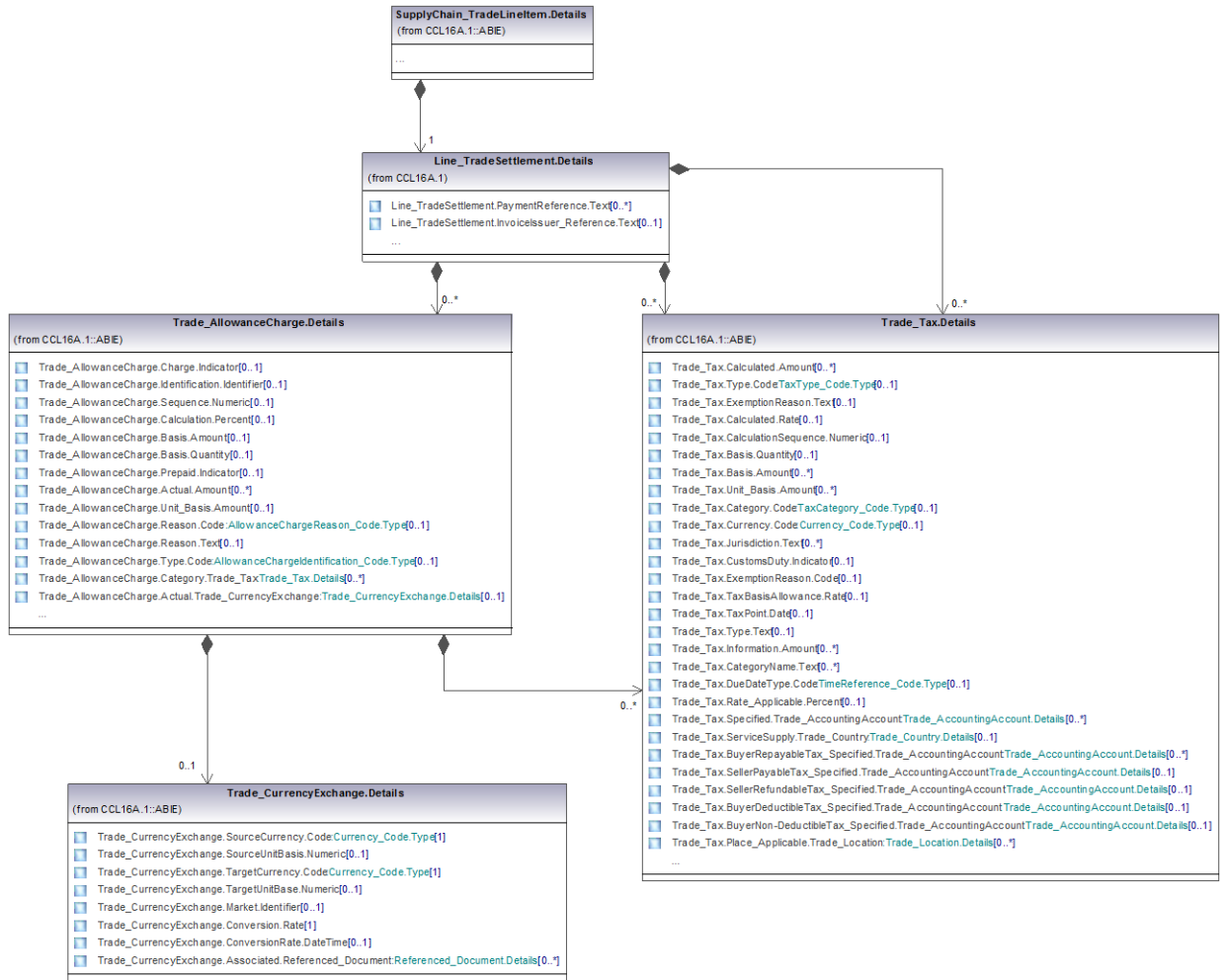

Figure 2.6.2-14 Trade Line Item

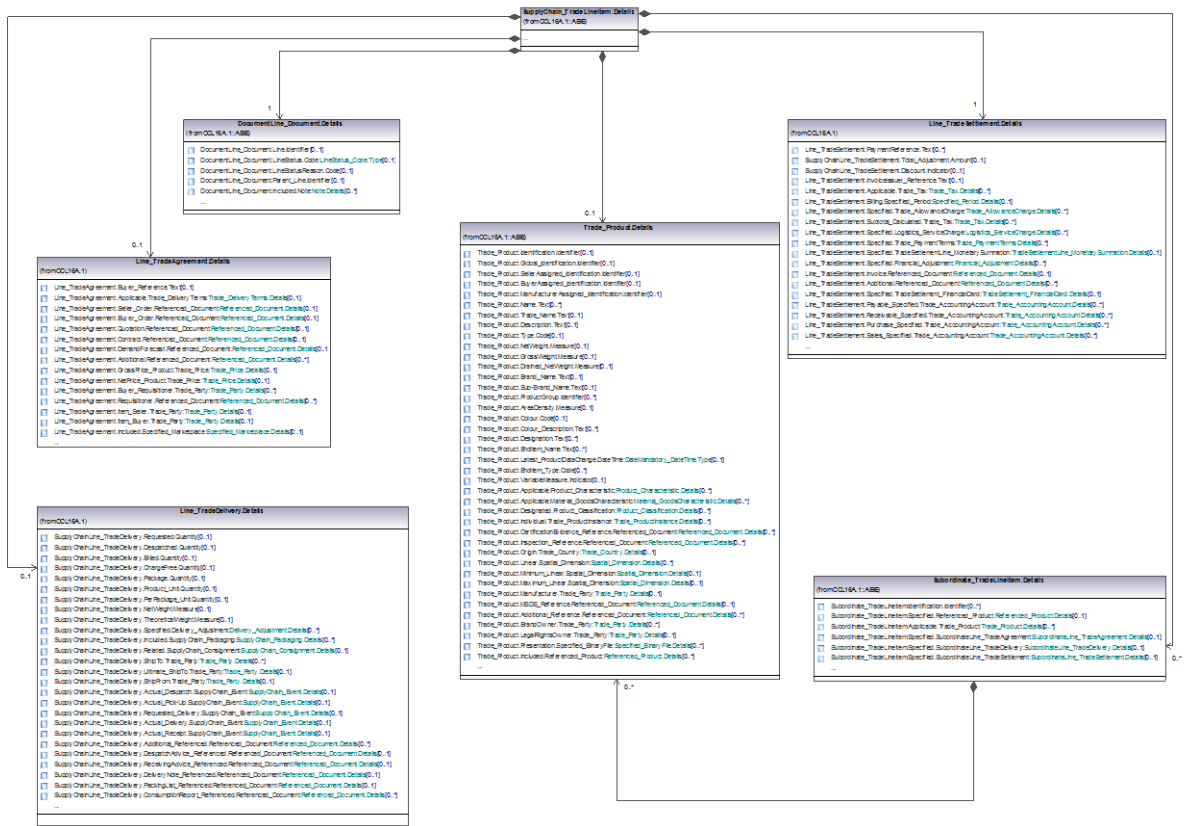

Figure 2.6.2-15 Trade Settlement Line_ Specified. Trade_ Allowance Charge

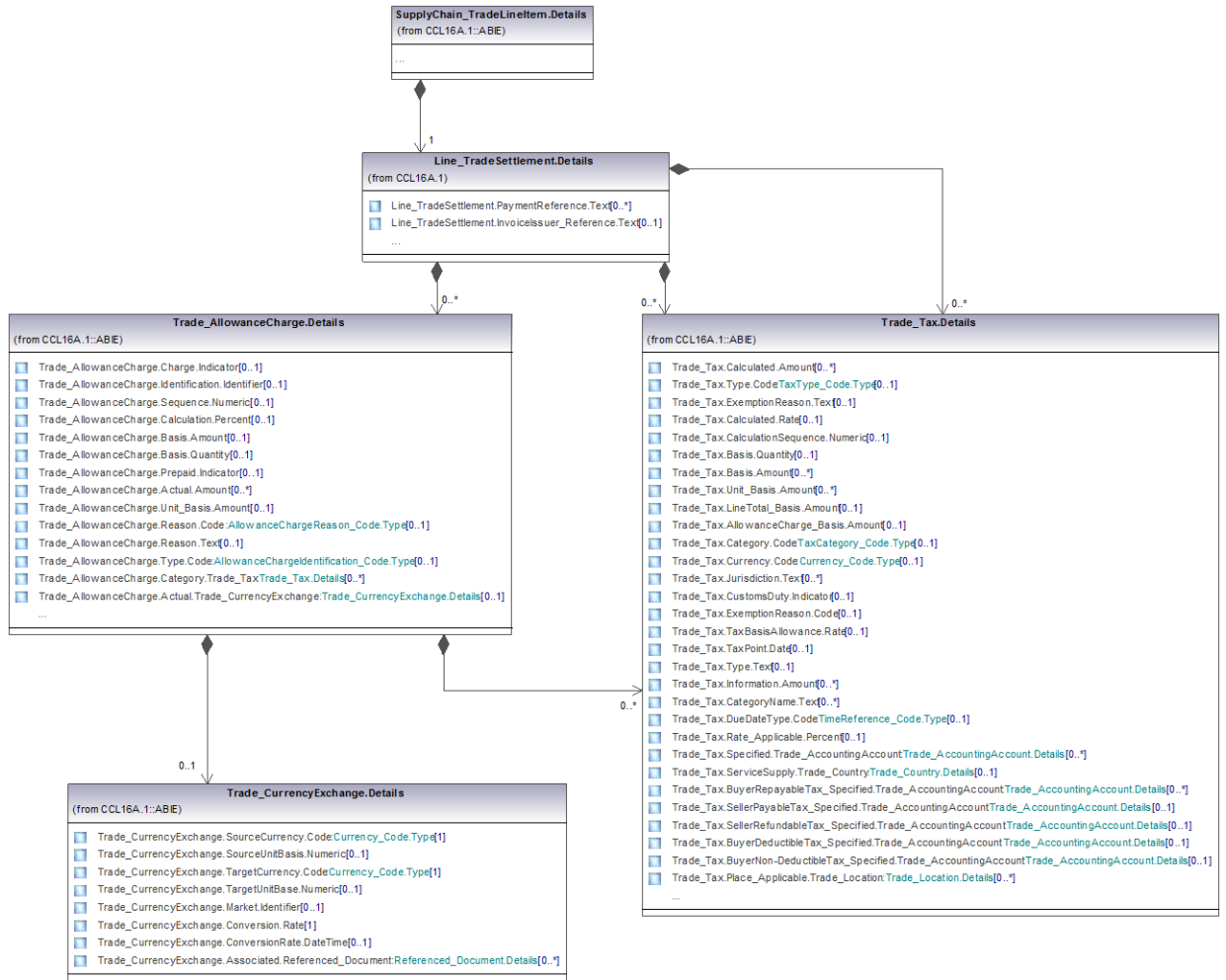

Figure 2.6.2-16 Trade Settlement Line_ Monetary Summation

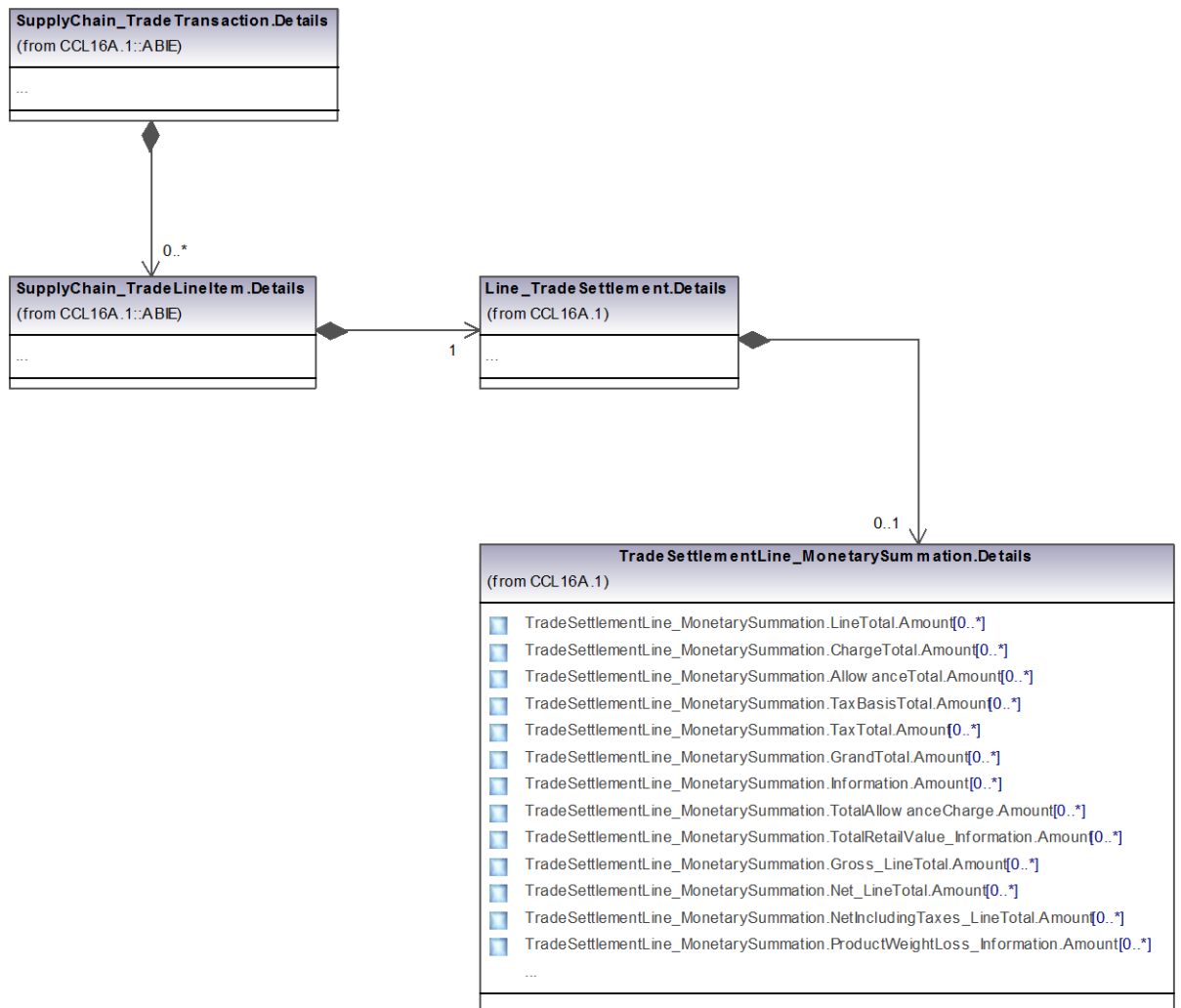
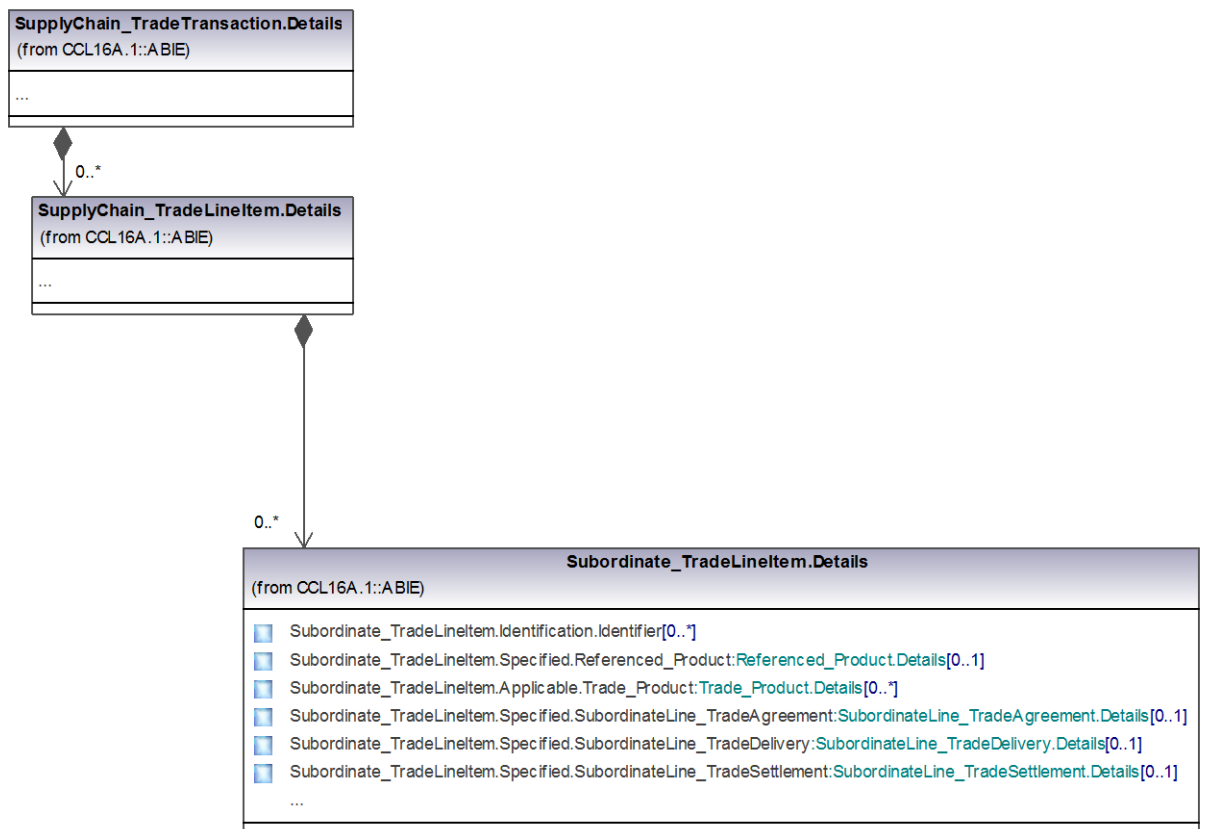

Figure 2.6.2-17 Subordinate_ Trade Line Item



2.6.3 Core Components Model Extract

Not applicable

2.6.3.1 New and Changed Components

Not applicable

2.6.3.2 New and Changed Core Data Types

Not applicable

2.6.3.3 Presentation

Not applicable

2.7 Logical Message Structure

2.7.1 Message Assembly

The purpose of this section is to describe the content or business information payload of each message by showing the top level ABIEs that connect to the root of the message.

The following messages are defined:

- Cross Industry Invoice

Table 3-1 Message Assembly Realization Table

Type MA/ASMA	Dictionary Entry Name	Definition	Message Name Qualifier(s)	Message Name	Occurrence Min	Occurrence Max
MA	Cross Industry_ Invoice. Details	A message used as a request for payment, or modification of a request for payment, for the supply of goods or services ordered, delivered, received, consumed.	Cross Industry	Invoice		
ASMA	Cross Industry_ Invoice. Exchanged Document_ Context	The set of context parameters specified for a use of this UNEDocs buy master message assembly.	Cross Industry	Invoice	1	1
ASMA	Cross Industry_ Invoice. Exchanged_ Document	The header document information for a use of this UNEDocs buy master message assembly.	Cross Industry	Invoice	1	1
ASMA	Cross Industry_ Invoice. Supply Chain_ Trade Transaction	A supply chain trade transaction specified for a use of this UNEDocs buy master message assembly.	Cross Industry	Invoice	1	1
ASMA	Cross Industry_ Invoice. Valuation_ Breakdown Statement	A detailed statement of work, prices, and dimensions for this cross industry invoice.	Cross Industry	Invoice	0	1



CCBDA Cross
Industry Message As

CCBDA Cross Industry Invoice Message Assemblyv1.xlsx

2.7.2 Business Information Entities Used

This section provides a complete listing of ABIEs required for all the messages defined in this RSM showing the ABIEs, Properties and Associations, their Dictionary Entry Names and cardinalities.

The following table of Aggregate Business Information Entities (ABIEs) represents the Business Information Entities used in the Cross Industry Invoice (CII) message.

Below, embedded excel file includes the CCL ABIE's and their relationship to the message Business Information Entities (MBIE's). Restrictions on the CCL ABIE's are shown in this file.



Relationship CCL
ABIE - CCBDA CII ME

Relationship CCL ABIE - CCBDA CII MBIE.xlsx

ABIE/ BBIE/ ASBIE	Dictionary Entry Name	Definition	Occurrence Min	Occurrence Max
ABIE	Advance_ Payment. Details	A prepaid discharge of obligations in respect of funds or securities transferred between two or more parties.		
BBIE	Advance_ Payment. Paid. Amount	The monetary value of the funds or securities paid in this advance payment.	1	1
BBIE	Advance_ Payment. Formatted_ Received. Date Time	The formatted date or date time value when an advance payment has been received.	0	1
ABIE	Applied_ Allowance Charge. Details	The applied allowance or charge component of pricing.		
BBIE	Applied_ Allowance Charge. Actual. Amount	The actual monetary value of the applied allowance charge.	0	1
BBIE	Applied_ Allowance Charge. Description. Text	The textual description of the applied allowance charge.	0	1
BBIE	Applied_ Allowance Charge. Reason. Code	The code specifying the reason for this applied allowance charge.	0	1
BBIE	Applied_ Allowance Charge. Calculation. Percent	The percentage used to calculate the applied allowance charge.	0	1
BBIE	Applied_ Allowance Charge. Basis. Amount	The monetary value that is the basis on which the applied allowance charge is calculated.	0	1
BBIE	Applied_ Allowance Charge. Charge. Indicator	The indication of whether or not the applied allowance charge is a charge.	1	1
ASBIE	Applied_ Allowance Charge. Category. Applied_ Tax	The applied tax category of this applied allowance charge.	0	1
ABIE	Applied_ Tax. Details	A total levy or payment for the support of a government that is required of persons, groups, or businesses within the domain of that government.		
BBIE	Applied_ Tax. Calculated. Amount	The monetary value resulting from the calculation of the applied tax.	0	1
BBIE	Applied_ Tax. Type. Code	The code specifying the applied tax type such as VAT.	0	1
BBIE	Applied_ Tax. Calculated. Rate	The rate used to calculate the applied tax.	0	1
BBIE	Applied_ Tax. Basis. Amount	The monetary value used as the basis in calculating the applied tax.	0	1
BBIE	Applied_ Tax. Tax Point. Date	The date of the tax point when taxes, such as VAT, are to be applied.	0	1

ABIE/ BBIE/ ASBIE	Dictionary Entry Name	Definition	Occurrence Min	Occurrence Max
ABIE	Available_Period. Details	A specific period of time such as the length of time between two known date/time points, from a start date onwards, or up to an end date for which something is available.		
BBIE	Available_Period. Start. Date Time	The date, time, date time or other date time value for the start of this available period of time.	0	1
BBIE	Available_Period. End. Date Time	The date, time, date time or other date time value for the end of this available period of time.	0	1
BBIE	Available_Period. Description. Text	The textual description of this available period.	0	1
ABIE	Basic_Work Item. Details	A basic item of work.		
BBIE	Basic_Work Item. Identification. Identifier	The unique identifier for this basic work item.	1	1
BBIE	Basic_Work Item. Reference_ Identification. Identifier	The unique identifier of another work item referenced by this basic work item.	0	1
BBIE	Basic_Work Item. Primary_ Classification. Code	A code specifying the primary classification for this basic work item.	0	unbounded
BBIE	Basic_Work Item. Alternative_ Classification. Code	A code specifying an alternative classification for this basic work item.	0	unbounded
BBIE	Basic_Work Item. Type. Code	A code specifying the type of basic work item.	0	unbounded
BBIE	Basic_Work Item. Comment. Text	A comment, expressed as text, for this basic work item.	0	unbounded
BBIE	Basic_Work Item. Total. Quantity	The total quantity for this basic work item.	0	1
BBIE	Basic_Work Item. Total Quantity Classification. Code	The code specifying the classification of the total quantity for this basic work item.	0	1
BBIE	Basic_Work Item. Index. Value	The index value for this basic work item.	0	1
BBIE	Basic_Work Item. Status. Code	A code specifying the status of this basic work item.	0	unbounded
BBIE	Basic_Work Item. Reference File. Binary Object	A reference file binary object related to this basic work item.	0	unbounded
BBIE	Basic_Work Item. Index. Text	The index, expressed as text, to be used for this basic work item.	0	1
BBIE	Basic_Work Item. Requested Action. Code	A code specifying a requested action for this basic work item.	0	unbounded
BBIE	Basic_Work Item. Price List Item_ Identification. Identifier	The unique identifier of a price list item for this basic work item.	0	1

ABIE/ BBIE/ ASBIE	Dictionary Entry Name	Definition	Occurrence Min	Occurrence Max
BBIE	Basic_ Work Item. Contractual Language. Code	The code specifying the contractual language for this basic work item.	0	1
ASBIE	Basic_ Work Item. Actual. Work Item_ Complex Description	An actual complex description for this basic work item.	0	unbounded
ASBIE	Basic_ Work Item. Total Quantity. Work Item_ Quantity Analysis	An analysis of the total quantity for this basic work item.	0	unbounded
ASBIE	Basic_ Work Item. Unit. Calculated_ Price	A unit calculated price for this basic work item.	0	unbounded
ASBIE	Basic_ Work Item. Total. Calculated_ Price	A total calculated price for this basic work item.	0	unbounded
ASBIE	Basic_ Work Item. Subordinate. Basic_ Work Item	A subordinate work item for this basic work item.	0	unbounded
ASBIE	Basic_ Work Item. Changed. Recorded_ Status	A changed recorded status for this basic work item.	0	unbounded
ASBIE	Basic_ Work Item. Item. Basic_ Work Item	A basic work item in this basic work item.	0	unbounded
ASBIE	Basic_ Work Item. Referenced. Specified_ Binary File	A specified binary file referenced by this basic work item.	0	unbounded
ABIE	Branch_ Financial Institution. Details	A sub-division of a bank, building society, credit union, stock brokerage, or similar business; established primarily to provide financial services and financial transactions.		
BBIE	Branch_ Financial Institution. Identification. Identifier	The unique identifier for this branch of a financial institution.	0	1
BBIE	Branch_ Financial Institution. Name. Text	The name, expressed as text, for this branch of a financial institution.	0	1
ASBIE	Branch_ Financial Institution. Location. Financial Institution_ Address	The location address for this branch of a financial institution.	0	1
ABIE	Calculated_ Price. Details	Information related to a calculated price.		
BBIE	Calculated_ Price. Type. Code	A code specifying the type of calculated price.	0	unbounded
BBIE	Calculated_ Price. Charge. Amount	A monetary value of the calculated price to be charged.	0	unbounded
ASBIE	Calculated_ Price. Related. Applied_ Allowance Charge	Applied allowance charge information related to this calculated price.	0	unbounded
ABIE	Contact_ Person. Details	An individual human being in a position to give assistance or information.		

ABIE/ BBIE/ ASBIE	Dictionary Entry Name	Definition	Occurrence Min	Occurrence Max
BBIE	Contact_ Person. Given Name. Text	The name, expressed as text, given to this contact person, usually by parents at birth.	0	1
BBIE	Contact_ Person. Middle Name. Text	The middle name, expressed as text, of this contact person, usually given by parents at birth.	0	1
BBIE	Contact_ Person. Family Name. Text	The name, expressed as text, that this contact person shares with members of his/her family.	0	1
ABIE	Creditor_ Financial Account. Details	A specific business arrangement whereby credits arising from transactions are recorded.		
BBIE	Creditor_ Financial Account. IBAN_ Identification. Identifier	The unique International Bank Account Number (IBAN) identifier for this creditor financial account.	0	1
BBIE	Creditor_ Financial Account. Account Name. Text	The account name, expressed as text, of this creditor financial account.	0	1
BBIE	Creditor_ Financial Account. Proprietary_ Identification. Identifier	The unique proprietary identifier for this creditor financial account.	0	1
ABIE	Creditor_ Financial Institution. Details	A bank, building society, credit union, stock brokerage, or similar business of the party that receives money.		
BBIE	Creditor_ Financial Institution. BIC. Identifier	The unique Bank Identification Code (BIC) as defined in ISO 9362 for this creditor financial institution.	0	1
BBIE	Creditor_ Financial Institution. CHIPS Universal_ Identification. Identifier	The unique (United States) Clearing House Interbank Payments System (CHIPS) Universal Identification (UID) as assigned by the New York Clearing House for this creditor financial institution.	0	1
BBIE	Creditor_ Financial Institution. New Zealand NCC_ Identification. Identifier	The unique New Zealand National Clearing Code (NCC) identifier as assigned by the New Zealand Bankers' Association (NZBA) for this creditor financial institution.	0	1
BBIE	Creditor_ Financial Institution. Irish NSC_ Identification. Identifier	The unique Irish National Sorting Code (NSC) identifier as assigned by the Irish Payments Services Organisation (IPSO) for this creditor financial institution.	0	1

ABIE/ BBIE/ ASBIE	Dictionary Entry Name	Definition	Occurrence Min	Occurrence Max
BBIE	Creditor_ Financial Institution. UK Sort Code_ Identification. Identifier	The unique United Kingdom (UK) Sort Code identifier as assigned by the UK Payment Association (APACS) for this creditor financial institution.	0	1
BBIE	Creditor_ Financial Institution. CHIPS Participant_ Identification. Identifier	The unique (United States) Clearing House Interbank Payment System (CHIPS) Participant Identifier (ID) as assigned by the New York Clearing House for this creditor financial institution.	0	1
BBIE	Creditor_ Financial Institution. Swiss BC_ Identification. Identifier	The unique Swiss Bank Code (BC) identifier for this creditor financial institution.	0	1
BBIE	Creditor_ Financial Institution. Fedwire Routing Number_ Identification. Identifier	The unique Fedwire Routing Number identifier as assigned by the American Bankers Association (ABA) for this creditor financial institution.	0	1
BBIE	Creditor_ Financial Institution. Portuguese NCC_ Identification. Identifier	The unique Portuguese National Clearing Code (NCC) identifier for this creditor financial institution.	0	1
BBIE	Creditor_ Financial Institution. Russian Central Bank_ Identification. Identifier	The unique Russian Central Bank Identification Code identifier for this creditor financial institution.	0	1
BBIE	Creditor_ Financial Institution. Italian Domestic_ Identification. Identifier	The unique Italian Domestic Identification Code identifier as assigned by the Associazione Bancaria Italiana (ABI) for this creditor financial institution.	0	1
BBIE	Creditor_ Financial Institution. Austrian Bankleitzahl_ Identification. Identifier	The unique Austrian Bankleitzahl identifier for this creditor financial institution.	0	1
BBIE	Creditor_ Financial Institution. Canadian Payments Association_ Identification. Identifier	The unique Canadian Payments Association Routing Number identifier for this creditor financial institution.	0	1
BBIE	Creditor_ Financial Institution. SIC_ Identification. Identifier	The unique Swiss Interbank Clearing (SIC) Code identifier for this creditor financial institution.	0	1
BBIE	Creditor_ Financial Institution. German Bankleitzahl_ Identification. Identifier	The unique German Bankleitzahl identifier for this creditor financial institution.	0	1
BBIE	Creditor_ Financial Institution. Spanish Domestic Interbanking_ Identification. Identifier	The unique Spanish Domestic Interbanking Code identifier as assigned by the Centro de Cooperacion Interbancaria (CCI) for this creditor financial	0	1

ABIE/ BBIE/ ASBIE	Dictionary Entry Name	Definition	Occurrence Min	Occurrence Max
		institution.		
BBIE	Creditor_ Financial Institution. South African NCC_ Identification. Identifier	The unique South African National Clearing Code (NCC) identifier as assigned by the South African Bankers Services Company Ltd. (BankServ) for this creditor financial institution.	0	1
BBIE	Creditor_ Financial Institution. Hong Kong Bank_ Identification. Identifier	The unique Hong Kong Bank Code identifier for this creditor financial institution.	0	1
BBIE	Creditor_ Financial Institution. Australian BSB_ Identification. Identifier	The unique Australian Bank State Branch (BSB) Code identifier as assigned by the Australian Payments Clearing Association (APCA) for this creditor financial institution.	0	1
BBIE	Creditor_ Financial Institution. Indian Financial System_ Identification. Identifier	The unique Indian Financial System Code identifier for this creditor financial institution.	0	1
BBIE	Creditor_ Financial Institution. Hellenic Bank_ Identification. Identifier	The unique Hellenic Bank Identification Code identifier for this creditor financial institution.	0	1
BBIE	Creditor_ Financial Institution. Polish National Clearing_ Identification. Identifier	The unique Polish National Clearing Code identifier for this creditor financial institution.	0	1
BBIE	Creditor_ Financial Institution. Name. Text	The name, expressed as text, for this creditor financial institution.	0	1
BBIE	Creditor_ Financial Institution. Clearing System Name. Text	The clearing system name, expressed as text, for this creditor financial institution.	0	1
BBIE	Creditor_ Financial Institution. Japan Financial Institution Common_ Identification. Identifier	The Japan Financial Institution Common identifier as assigned by the Japanese Bankers Association for this creditor financial institution.	0	1
ASBIE	Creditor_ Financial Institution. Location. Financial Institution_ Address	The location address for this creditor financial institution.	0	1
ASBIE	Creditor_ Financial Institution. Sub-Division. Branch_ Financial Institution	The branch financial institution for this creditor financial institution.	0	1
ABIE	Debtor_ Financial Account. Details	A specific business arrangement whereby debits arising from transactions are recorded.		

ABIE/ BBIE/ ASBIE	Dictionary Entry Name	Definition	Occurrence Min	Occurrence Max
BBIE	Debtor_ Financial Account. IBAN_ Identification. Identifier	The unique International Bank Account Number (IBAN) identifier for this debtor financial account.	0	1
BBIE	Debtor_ Financial Account. Account Name. Text	The account name, expressed as text, of this debtor financial account.	0	1
BBIE	Debtor_ Financial Account. Proprietary_ Identification. Identifier	The unique proprietary identifier for this debtor financial account.	0	1
ABIE	Debtor_ Financial Institution. Details	A bank, building society, credit union, stock brokerage, or similar business of the party that owes money.		
BBIE	Debtor_ Financial Institution. BIC. Identifier	The unique Bank Identification Code (BIC) as defined in ISO 9362 for this debtor financial institution.	0	1
BBIE	Debtor_ Financial Institution. Clearing System Name. Text	The clearing system name, expressed as text, for this debtor financial institution.	0	1
BBIE	Debtor_ Financial Institution. CHIPS Universal_ Identification. Identifier	The unique (United States) Clearing House Interbank Payments System (CHIPS) Universal Identification (UID) as assigned by the New York Clearing House for this debtor financial institution.	0	1
BBIE	Debtor_ Financial Institution. New Zealand NCC_ Identification. Identifier	The unique New Zealand National Clearing Code (NCC) identifier as assigned by the New Zealand Bankers' Association (NZBA) for this debtor financial institution.	0	1
BBIE	Debtor_ Financial Institution. Irish NSC_ Identification. Identifier	The unique Irish National Sorting Code (NSC) identifier as assigned by the Irish Payments Services Organisation (IPSO) for this debtor financial institution.	0	1
BBIE	Debtor_ Financial Institution. UK Sort Code_ Identification. Identifier	The unique United Kingdom (UK) Sort Code identifier as assigned by the UK Payment Association (APACS) for this debtor financial institution.	0	1
BBIE	Debtor_ Financial Institution. CHIPS Participant_ Identification. Identifier	The unique (United States) Clearing House Interbank Payment System (CHIPS) Participant Identifier (ID) as assigned by the New York Clearing House for this debtor financial institution.	0	1

ABIE/ BBIE/ ASBIE	Dictionary Entry Name	Definition	Occurrence Min	Occurrence Max
BBIE	Debtor_ Financial Institution. Swiss BC_ Identification. Identifier	The unique Swiss Bank Code (BC) identifier for this debtor financial institution.	0	1
BBIE	Debtor_ Financial Institution. Fedwire Routing Number_ Identification. Identifier	The unique Fedwire Routing Number identifier as assigned by the American Bankers Association (ABA) for this debtor financial institution.	0	1
BBIE	Debtor_ Financial Institution. Portuguese NCC_ Identification. Identifier	The unique Portuguese National Clearing Code (NCC) identifier for this debtor financial institution.	0	1
BBIE	Debtor_ Financial Institution. Russian Central Bank_ Identification. Identifier	The unique Russian Central Bank Identification Code identifier for this debtor financial institution.	0	1
BBIE	Debtor_ Financial Institution. Italian Domestic_ Identification. Identifier	The unique Italian Domestic Identification Code identifier as assigned by the Associazione Bancaria Italiana (ABI) for this debtor financial institution.	0	1
BBIE	Debtor_ Financial Institution. Austrian Bankleitzahl_ Identification. Identifier	The unique Austrian Bankleitzahl identifier for this debtor financial institution.	0	1
BBIE	Debtor_ Financial Institution. Canadian Payments Association_ Identification. Identifier	The unique Canadian Payments Association Routing Number identifier for this debtor financial institution.	0	1
BBIE	Debtor_ Financial Institution. SIC_ Identification. Identifier	The unique Swiss Interbank Clearing (SIC) Code identifier for this debtor financial institution.	0	1
BBIE	Debtor_ Financial Institution. German Bankleitzahl_ Identification. Identifier	The unique German Bankleitzahl identifier for this debtor financial institution.	0	1
BBIE	Debtor_ Financial Institution. Spanish Domestic Interbanking_ Identification. Identifier	The unique Spanish Domestic Interbanking Code identifier as assigned by the Centro de Cooperacion Interbancaria (CCI) for this debtor financial institution.	0	1
BBIE	Debtor_ Financial Institution. South African NCC_ Identification. Identifier	The unique South African National Clearing Code (NCC) identifier as assigned by the South African Bankers Services Company Ltd. (BankServ) for this debtor financial institution.	0	1
BBIE	Debtor_ Financial Institution. Hong Kong Bank_ Identification. Identifier	The unique Hong Kong Bank Code identifier for this debtor financial institution.	0	1

ABIE/ BBIE/ ASBIE	Dictionary Entry Name	Definition	Occurrence Min	Occurrence Max
BBIE	Debtor_ Financial Institution. Australian BSB_ Identification. Identifier	The unique Australian Bank State Branch (BSB) Code identifier as assigned by the Australian Payments Clearing Association (APCA) for this debtor financial institution.	0	1
BBIE	Debtor_ Financial Institution. Indian Financial System_ Identification. Identifier	The unique Indian Financial System Code identifier for this debtor financial institution.	0	1
BBIE	Debtor_ Financial Institution. Hellenic Bank_ Identification. Identifier	The unique Hellenic Bank Identification Code identifier for this debtor financial institution.	0	1
BBIE	Debtor_ Financial Institution. Polish National Clearing_ Identification. Identifier	The unique Polish National Clearing Code identifier for this debtor financial institution.	0	1
BBIE	Debtor_ Financial Institution. Name. Text	The name, expressed as text, for this debtor financial institution.	0	1
BBIE	Debtor_ Financial Institution. Japan Financial Institution Common_ Identification. Identifier	The Japan Financial Institution Common identifier as assigned by the Japanese Bankers Association for this debtor financial institution.	0	1
ASBIE	Debtor_ Financial Institution. Location. Financial Institution_ Address	The location address for this debtor financial institution.	0	1
ASBIE	Debtor_ Financial Institution. Sub-Division. Branch_ Financial Institution	The branch financial institution for this debtor financial institution.	0	1
ABIE	Delivery_ Adjustment. Details	A correction or modification to reflect actual delivery conditions.		
BBIE	Delivery_ Adjustment. Reason. Code	The code specifying a reason for this delivery adjustment.	0	1
BBIE	Delivery_ Adjustment. Reason. Text	A reason, expressed as text, for this delivery adjustment.	0	unbounded
BBIE	Delivery_ Adjustment. Actual. Amount	An actual monetary value added or subtracted as a result of this delivery adjustment.	0	unbounded
BBIE	Delivery_ Adjustment. Actual. Quantity	The actual quantity added or subtracted as a result of this delivery adjustment.	0	1
BBIE	Delivery_ Adjustment. Actual. Date Time	The actual date, time, date time, or other date time value of this delivery adjustment.	0	1
ABIE	Disposal_ Instructions. Details	A set of instructions detailing how to properly dispose of a material.		
BBIE	Disposal_ Instructions. Material. Identifier	The identifier of the material to which these disposal instructions apply.	0	1

ABIE/ BBIE/ ASBIE	Dictionary Entry Name	Definition	Occurrence Min	Occurrence Max
BBIE	Disposal_ Instructions. Recycling_ Description. Code	A code describing recycling in these disposal instructions.	0	unbounded
BBIE	Disposal_ Instructions. Description. Text	A textual description of these disposal instructions.	0	unbounded
BBIE	Disposal_ Instructions. Recycling_ Procedure. Text	A recycling procedure, expressed as text, for these disposal instructions.	0	unbounded
ABIE	Document Context_ Parameter. Details	A feature that is fixed for a particular document context.		
BBIE	Document Context_ Parameter. Identification. Identifier	The unique identifier of this document context parameter.	0	1
BBIE	Document Context_ Parameter. Value. Text	The value, expressed as text, of this document context parameter.	0	1
ASBIE	Document Context_ Parameter. Specified. Document_ Version	The document version specified for this document context parameter.	0	1
ABIE	Document Line_ Document. Details	A collection of data for a line on a piece of written, printed or electronic matter that provides information or evidence.		
BBIE	Document Line_ Document. Line. Identifier	The unique identifier of this document line.	0	1
BBIE	Document Line_ Document. Parent_ Line. Identifier	The unique identifier of the parent line to this document line.	0	1
BBIE	Document Line_ Document. Line Status. Code	The code specifying the status of this document line.	0	1
BBIE	Document Line_ Document. Line Status Reason. Code	The code specifying the line status reason for this document line.	0	1
ASBIE	Document Line_ Document. Included. Note	A note included in this document line.	0	unbounded
ABIE	Document_ Version. Details	A specific variant of a document.		
BBIE	Document_ Version. Identification. Identifier	The unique identifier for this document version.	0	1
BBIE	Document_ Version. Name. Text	The name, expressed as text, of this document version.	0	1
BBIE	Document_ Version. Issue. Date Time	The date, time, date and time or other date time value of issue of this document version.	0	1
ABIE	Exchanged Document_ Context. Details	The scenario or setting of an exchanged document, such as its business process application context.		
BBIE	Exchanged Document_ Context. Specified_ Transaction. Identifier	The identifier of a specified transaction in this exchanged document context.	0	1

ABIE/ BBIE/ ASBIE	Dictionary Entry Name	Definition	Occurrence Min	Occurrence Max
BBIE	Exchanged Document_ Context. Test. Indicator	The indication of whether or not this exchanged document context is a test.	0	1
ASBIE	Exchanged Document_ Context. Business Process_ Specified. Document Context_ Parameter	A business process context parameter specified for this exchanged document context.	0	unbounded
ASBIE	Exchanged Document_ Context. BIM_ Specified. Document Context_ Parameter	A Business Information Master (BIM) context parameter specified for this exchanged document context.	0	unbounded
ASBIE	Exchanged Document_ Context. Scenario_ Specified. Document Context_ Parameter	A scenario context parameter specified for this exchanged document context.	0	unbounded
ASBIE	Exchanged Document_ Context. Application_ Specified. Document Context_ Parameter	An application context parameter specified for this exchanged document context.	0	unbounded
ASBIE	Exchanged Document_ Context. Guideline_ Specified. Document Context_ Parameter	A guideline context parameter specified for this exchanged document context.	0	unbounded
ASBIE	Exchanged Document_ Context. Subset_ Specified. Document Context_ Parameter	A subset context parameter specified for this exchanged document context.	0	unbounded
ASBIE	Exchanged Document_ Context. Message Standard_ Specified. Document Context_ Parameter	The message standard document context parameter specified for this exchanged document context.	0	1
ABIE	Exchanged_ Document. Details	A collection of data for a piece of written, printed or electronic matter that is exchanged between two or more parties.		
BBIE	Exchanged_ Document. Identification. Identifier	The unique identifier of this exchanged document.	1	1
BBIE	Exchanged_ Document. Name. Text	A name, expressed as text, of this exchanged document.	0	unbounded
BBIE	Exchanged_ Document. Type. Code	The code specifying the type of exchanged document.	0	1
BBIE	Exchanged_ Document. Issue. Date Time	The date, time, date time or other date time value for the issuance of this exchanged document.	1	1
BBIE	Exchanged_ Document. Copy. Indicator	The indication of whether or not this exchanged document is a copy.	0	1
BBIE	Exchanged_ Document. Purpose. Text	The purpose, expressed as text, of this exchanged document.	0	1
BBIE	Exchanged_ Document. Control Requirement. Indicator	The indication of whether or not this exchanged document has specific control	0	1

ABIE/ BBIE/ ASBIE	Dictionary Entry Name	Definition	Occurrence Min	Occurrence Max
		requirements.		
BBIE	Exchanged_ Document. Language. Identifier	A unique identifier for a language used in this exchanged document.	0	unbounded
BBIE	Exchanged_ Document. Purpose. Code	A code specifying the purpose of this exchanged document, such as request or reminder.	0	1
BBIE	Exchanged_ Document. Revision. Date Time	The date, time, date time or other date time value for the revision of this exchanged document.	0	1
BBIE	Exchanged_ Document. Version_ Identification. Identifier	The unique identifier for the version of this exchanged document.	0	1
BBIE	Exchanged_ Document. Global_ Identification. Identifier	The unique global identifier for this exchanged document.	0	1
BBIE	Exchanged_ Document. Revision_ Identification. Identifier	The unique identifier of the revision of this exchanged document.	0	1
BBIE	Exchanged_ Document. Previous Revision_ Identification. Identifier	The unique identifier of the previous revision of this exchanged document.	0	1
BBIE	Exchanged_ Document. Category. Code	The code specifying a category for this exchanged document.	0	1
ASBIE	Exchanged_ Document. Included. Note	A note included in this exchanged document.	0	unbounded
ASBIE	Exchanged_ Document. Effective. Specified_ Period	The specified period within which this exchanged document is effective.	0	1
ASBIE	Exchanged_ Document. Issuer. Trade_ Party	The party that issues this exchanged document.	0	1
ABIE	Financial Institution_ Address. Details	The location at which a financial institution may be found or reached.		
BBIE	Financial Institution_ Address. Postcode. Code	The code specifying the postcode for this financial institution address.	0	1
BBIE	Financial Institution_ Address. Building Number. Text	The number, expressed as text, of the building on a street for this financial institution address.	0	1
BBIE	Financial Institution_ Address. Line One. Text	The first free form line, expressed as text, of this financial institution address.	0	1
BBIE	Financial Institution_ Address. Line Two. Text	The second free form line, expressed as text, of this financial institution address.	0	1

ABIE/ BBIE/ ASBIE	Dictionary Entry Name	Definition	Occurrence Min	Occurrence Max
BBIE	Financial Institution_ Address. Line Three. Text	The third free form line, expressed as text, of this financial institution address.	0	1
BBIE	Financial Institution_ Address. Line Four. Text	The fourth free form line, expressed as text, of this financial institution address.	0	1
BBIE	Financial Institution_ Address. Line Five. Text	The fifth free form line, expressed as text, of this financial institution address.	0	1
BBIE	Financial Institution_ Address. Street Name. Text	The name, expressed as text, of the street or thoroughfare for this financial institution address.	0	1
BBIE	Financial Institution_ Address. City Name. Text	The name, expressed as text, of the city, town or village of this financial institution address.	0	1
BBIE	Financial Institution_ Address. Country Sub-Division. Identifier	The unique identifier of a country sub-division for this financial institution address (Reference ISO 3166 and UN/ECE Rec 3).	0	1
BBIE	Financial Institution_ Address. Country. Identifier	The unique identifier of a country for this financial institution address (Reference ISO 3166 and UN/ECE Rec 3).	0	1
BBIE	Financial Institution_ Address. Type. Code	The code specifying the type of financial institution address.	0	1
BBIE	Financial Institution_ Address. Department Name. Text	The name, expressed as text, of a department within this financial institution address.	0	1
BBIE	Financial Institution_ Address. Post Office Box. Text	The post office box, expressed as text, for this financial institution address.	0	1
BBIE	Financial Institution_ Address. City. Identifier	The unique identifier of the city for this financial institution address, such as United Nations Location Code (UNLOCODE).	0	1
BBIE	Financial Institution_ Address. Country Sub-Division Name. Text	The name, expressed as text, of a country sub-division within this financial institution address.	0	1
BBIE	Financial Institution_ Address. Country Name. Text	The name, expressed as text, of the country within this financial institution address.	0	1
ABIE	Financial_ Adjustment. Details	A correction or modification to reflect actual financial conditions.		
BBIE	Financial_ Adjustment. Reason. Code	A code specifying a reason for this financial adjustment.	0	1
BBIE	Financial_ Adjustment. Reason. Text	A reason, expressed as text, for this financial adjustment.	0	unbounded

ABIE/ BBIE/ ASBIE	Dictionary Entry Name	Definition	Occurrence Min	Occurrence Max
BBIE	Financial_ Adjustment. Actual. Amount	An actual monetary value added or subtracted as a result of this financial adjustment.	0	unbounded
BBIE	Financial_ Adjustment. Actual. Quantity	The actual quantity added or subtracted as a result of this financial adjustment.	0	1
BBIE	Financial_ Adjustment. Actual. Date Time	The actual date, time, date time, or other date time value of this financial adjustment.	0	1
ASBIE	Financial_ Adjustment. Claim_ Related. Trade_ Party	The claim related party for this financial adjustment.	0	1
ASBIE	Financial_ Adjustment. Invoice_ Reference. Referenced_ Document	The invoice document referenced for this financial adjustment.	0	1
ABIE	Geographical Coordinate. Details	A set of geographical coordinates of a specific point such as the longitude, latitude and altitude.		
BBIE	Geographical Coordinate. Altitude. Measure	The measure of the altitude that reflects the vertical elevation of an object above a surface for this geographical coordinate (Reference ISO 6709).	0	1
BBIE	Geographical Coordinate. Latitude. Measure	The measure of the latitude as an angular distance north or south from the Equator meridian to the meridian of a specific place for this geographical coordinate (Reference ISO 6709).	0	1
BBIE	Geographical Coordinate. Longitude. Measure	The measure of the longitude as an angular distance east or west from the Greenwich meridian to the meridian of a specific place (Reference ISO 6709).	0	1
BBIE	Geographical Coordinate. System. Identifier	The unique identifier of the reference system used for measuring a geographical coordinate.	0	1
ABIE	Grouped_ Work Item. Details	A grouping of related work items.		
BBIE	Grouped_ Work Item. Identification. Identifier	The unique identifier for this work item group.	1	1
BBIE	Grouped_ Work Item. Primary_ Classification. Code	A code specifying the primary classification for this work item group.	0	unbounded
BBIE	Grouped_ Work Item. Alternative_ Classification. Code	A code specifying an alternative classification for this work item group.	0	unbounded
BBIE	Grouped_ Work Item. Index. Value	The index value for this work item group.	0	1

ABIE/ BBIE/ ASBIE	Dictionary Entry Name	Definition	Occurrence Min	Occurrence Max
BBIE	Grouped_ Work Item. Type. Code	A code specifying the type of this work item group.	0	unbounded
BBIE	Grouped_ Work Item. Comment. Text	A comment, expressed as text, for this work item group.	0	unbounded
BBIE	Grouped_ Work Item. Description. Text	A textual description of this work item group.	0	unbounded
BBIE	Grouped_ Work Item. Reference File. Binary Object	A reference file binary object related to this work item group.	0	unbounded
BBIE	Grouped_ Work Item. Total. Quantity	The total quantity of this work item group.	0	1
BBIE	Grouped_ Work Item. Index. Text	The index, expressed as text, to be used for this grouped work item.	0	1
BBIE	Grouped_ Work Item. Requested Action. Code	A code specifying a requested action for this grouped work item.	0	unbounded
BBIE	Grouped_ Work Item. Price List Item_ Identification. Identifier	The identifier of a price list item for this grouped work item.	0	1
BBIE	Grouped_ Work Item. Contractual Language. Code	The code specifying the contractual language for this grouped work item.	0	1
ASBIE	Grouped_ Work Item. Subordinate. Grouped_ Work Item	A subordinate work item group in this work item group.	0	unbounded
ASBIE	Grouped_ Work Item. Subordinate. Basic_ Work Item	A subordinate basic work item in this work item group.	0	unbounded
ASBIE	Grouped_ Work Item. Total. Calculated_ Price	A total calculated price for this work item group.	0	unbounded
ASBIE	Grouped_ Work Item. Item. Grouped_ Work Item	A grouped work item within this grouped work item.	0	unbounded
ASBIE	Grouped_ Work Item. Item. Basic_ Work Item	A basic work item within this grouped work item.	0	unbounded
ASBIE	Grouped_ Work Item. Changed. Recorded_ Status	A changed recorded status for this grouped work item.	0	unbounded
ASBIE	Grouped_ Work Item. Actual. Work Item_ Complex Description	An actual complex description for this work item group.	0	unbounded
ASBIE	Grouped_ Work Item. Referenced. Specified_ Binary File	A specified binary file referenced by this grouped work item.	0	unbounded
ABIE	Header_ Trade Agreement. Details	The contractual terms of a header trade agreement.		
BBIE	Header_ Trade Agreement. Reference. Text	A reference, expressed as text, for this header trade agreement.	0	inbounded
BBIE	Header_ Trade Agreement. Buyer_ Reference. Text	A buyer reference, expressed as text, for this header trade agreement.	0	1
ASBIE	Header_ Trade Agreement. Seller. Trade_ Party	The seller party for this header trade agreement.	0	1

ABIE/ BBIE/ ASBIE	Dictionary Entry Name	Definition	Occurrence Min	Occurrence Max
ASBIE	Header_ Trade Agreement. Buyer. Trade_ Party	The buyer party for this header trade agreement.	0	1
ASBIE	Header_ Trade Agreement. Sales Agent. Trade_ Party	The agent party representing the seller for this header trade agreement.	0	1
ASBIE	Header_ Trade Agreement. Buyer_ Requisitioner. Trade_ Party	A party who is a buyer requisitioner in this header trade agreement.	0	unbounded
ASBIE	Header_ Trade Agreement. Buyer_ Assigned Accountant. Trade_ Party	The party assigned as an accountant by the buyer for this header trade agreement.	0	1
ASBIE	Header_ Trade Agreement. Seller_ Assigned Accountant. Trade_ Party	The party assigned as an accountant by the seller for this header trade agreement.	0	1
ASBIE	Header_ Trade Agreement. Buyer_ Tax Representative. Trade_ Party	The party acting as a tax representative for the buyer for this header trade agreement.	0	1
ASBIE	Header_ Trade Agreement. Seller_ Tax Representative. Trade_ Party	The party acting as a tax representative for the seller for this header trade agreement.	0	1
ASBIE	Header_ Trade Agreement. Product End User. Trade_ Party	The party acting as the end user for the products in this header trade agreement.	0	1
ASBIE	Header_ Trade Agreement. Applicable. Trade_ Delivery Terms	The terms of delivery applicable to this header trade agreement.	0	1
ASBIE	Header_ Trade Agreement. Seller_ Order. Referenced_ Document	The seller generated order document referenced in this header trade agreement.	0	1
ASBIE	Header_ Trade Agreement. Buyer_ Order. Referenced_ Document	The buyer generated order document referenced in this header trade agreement.	0	1
ASBIE	Header_ Trade Agreement. Quotation. Referenced_ Document	The quotation document referenced in this header trade agreement.	0	1
ASBIE	Header_ Trade Agreement. Order Response. Referenced_ Document	The order response document referenced in this header trade agreement.	0	1
ASBIE	Header_ Trade Agreement. Contract. Referenced_ Document	A contract document referenced in this header trade agreement.	0	1
ASBIE	Header_ Trade Agreement. Demand Forecast. Referenced_ Document	A demand forecast document referenced in this header trade agreement.	0	1
ASBIE	Header_ Trade Agreement. Supply Instruction. Referenced_ Document	A supply instruction document referenced in this header trade agreement.	0	1
ASBIE	Header_ Trade Agreement. Promotional Deal. Referenced_ Document	The promotional deal document referenced in this header trade agreement.	0	1

ABIE/ BBIE/ ASBIE	Dictionary Entry Name	Definition	Occurrence Min	Occurrence Max
ASBIE	Header_ Trade Agreement. Price List. Referenced_ Document	The price list document referenced in this header trade agreement.	0	1
ASBIE	Header_ Trade Agreement. Additional. Referenced_ Document	An additional document referenced in this header trade agreement.	0	unbounded
ASBIE	Header_ Trade Agreement. Requisitioner. Referenced_ Document	A requisitioner document referenced in this header trade agreement.	0	unbounded
ASBIE	Header_ Trade Agreement. Buyer Agent. Trade_ Party	The buyer agent party for this header trade agreement.	0	1
ASBIE	Header_ Trade Agreement. Purchase_ Conditions. Referenced_ Document	A purchase conditions document referenced in this header trade agreement.	0	1
ASBIE	Header_ Trade Agreement. Specified. Procuring_ Project	A procuring project specified for this header chain trade agreement.	0	1
ABIE	Header_ Trade Delivery. Details	Shipping arrangements and movement of products and or services including despatch and delivery at a header level.		
ASBIE	Header_ Trade Delivery. Related. Supply Chain_ Consignment	A consignment, at header level, related to this trade delivery.	0	1
ASBIE	Header_ Trade Delivery. Ship To. Trade_ Party	The ship to party, at header level, for this trade delivery.	0	1
ASBIE	Header_ Trade Delivery. Ultimate_ Ship To. Trade_ Party	The ultimate ship to party, at header level, for this trade delivery.	0	1
ASBIE	Header_ Trade Delivery. Ship From. Trade_ Party	The ship from party, at header level, for this trade delivery.	0	1
ASBIE	Header_ Trade Delivery. Actual_ Despatch. Supply Chain_ Event	An actual despatch event, at header level, for this trade delivery.	0	1
ASBIE	Header_ Trade Delivery. Actual_ Pick-Up. Supply Chain_ Event	The actual pick-up event, at header level, for this trade delivery.	0	1
ASBIE	Header_ Trade Delivery. Actual_ Delivery. Supply Chain_ Event	An actual delivery event, at header level, for this trade delivery.	0	1
ASBIE	Header_ Trade Delivery. Actual_ Receipt. Supply Chain_ Event	The actual receipt event, at header level, for this trade delivery.	0	1
ASBIE	Header_ Trade Delivery. Additional. Referenced_ Document	An additional document, at header level, referenced for this trade delivery.	0	unbounded
ASBIE	Header_ Trade Delivery. Despatch Advice. Referenced_ Document	The despatch advice document, at header level, referenced for this trade delivery.	0	1
ASBIE	Header_ Trade Delivery. Receiving Advice. Referenced_ Document	A receiving advice document, at header level, referenced for this trade delivery.	0	1

ABIE/ BBIE/ ASBIE	Dictionary Entry Name	Definition	Occurrence Min	Occurrence Max
ASBIE	Header_ Trade Delivery. Delivery Note. Referenced_ Document	The delivery note document, at header level, referenced for this trade delivery.	0	1
ASBIE	Header_ Trade Delivery. Consumption Report. Referenced_ Document	The consumption report document, at header level, referenced for this trade delivery.	0	1
ASBIE	Header_ Trade Delivery. Previous_ Delivery. Supply Chain_ Event	A previous delivery event, at header level, for this trade delivery.	0	unbounded
ABIE	Header_ Trade Settlement. Details	The information, at a header level, that enables the reconciliation of a financial transaction, with the item(s) that the financial transaction is intended to settle, such as a commercial invoice.		
BBIE	Header_ Trade Settlement. Due Payable. Amount	A monetary value that is an exact amount due and payable for this header trade settlement, such as the amount due to the creditor.	0	unbounded
BBIE	Header_ Trade Settlement. Creditor Reference Type. Code	A code specifying the creditor reference type for this header trade settlement.	0	unbounded
BBIE	Header_ Trade Settlement. Creditor Reference Type. Text	A creditor reference type, expressed as text, for this header trade settlement.	0	unbounded
BBIE	Header_ Trade Settlement. Creditor Reference Issuer. Identifier	An identifier of the creditor reference issuer for this header trade settlement.	0	unbounded
BBIE	Header_ Trade Settlement. Creditor Reference. Identifier	The identifier of the creditor reference for this header trade settlement, such as a specific identifier assigned by the creditor to reference the financial transaction.	0	1
BBIE	Header_ Trade Settlement. Payment Reference. Text	A payment reference, expressed as text, for this header trade settlement.	0	unbounded
BBIE	Header_ Trade Settlement. Tax_ Currency. Code	The code specifying the tax currency for this header trade settlement.	0	1
BBIE	Header_ Trade Settlement. Invoice_ Currency. Code	The code specifying the invoice currency for this header trade settlement.	0	1
BBIE	Header_ Trade Settlement. Payment_ Currency. Code	The code specifying the payment currency for this header trade settlement.	0	1
BBIE	Header_ Trade Settlement. Invoice Issuer_ Reference. Text	The invoice issuer reference, expressed as text, for this header trade settlement.	0	1

ABIE/ BBIE/ ASBIE	Dictionary Entry Name	Definition	Occurrence Min	Occurrence Max
BBIE	Header_ Trade Settlement. Invoice. Date Time	The date, time, date time or other date time value of the invoice in this header trade settlement.	0	1
BBIE	Header_ Trade Settlement. Next_ Invoice. Date Time	A date, time, date time or other date time value of a next invoice or invoices in this header trade settlement.	0	unbounded
BBIE	Header_ Trade Settlement. Credit Reason. Code	The code specifying the reason for a credit being given in this header trade settlement.	0	1
BBIE	Header_ Trade Settlement. Credit Reason. Text	A textual description of the reason for a credit being given in this header trade settlement.	0	unbounded
ASBIE	Header_ Trade Settlement. Invoicer. Trade_ Party	The party issuing the invoice for this header trade settlement.	0	1
ASBIE	Header_ Trade Settlement. Invoicee. Trade_ Party	The party to whom an invoice is issued for this header trade settlement.	0	1
ASBIE	Header_ Trade Settlement. Payee. Trade_ Party	A payee party for this header trade settlement.	0	1
ASBIE	Header_ Trade Settlement. Payer. Trade_ Party	The payer party for this header trade settlement.	0	1
ASBIE	Header_ Trade Settlement. Tax_ Applicable. Trade_ Currency Exchange	A currency exchange applicable to a tax in this header trade settlement.	0	1
ASBIE	Header_ Trade Settlement. Invoice_ Applicable. Trade_ Currency Exchange	The currency exchange applicable to the invoice in this header trade settlement.	0	1
ASBIE	Header_ Trade Settlement. Payment_ Applicable. Trade_ Currency Exchange	The currency exchange applicable to the payment in this header trade settlement.	0	1
ASBIE	Header_ Trade Settlement. Specified. Trade Settlement_ Payment Means	A payment means specified for this header trade settlement.	0	unbounded
ASBIE	Header_ Trade Settlement. Applicable. Trade_ Tax	A tax applicable to this header trade settlement.	0	unbounded
ASBIE	Header_ Trade Settlement. Billing. Specified_ Period	A billing period specified for this header trade settlement.	0	1
ASBIE	Header_ Trade Settlement. Specified. Trade_ Allowance Charge	An allowance or charge specified for this header trade settlement.	0	unbounded
ASBIE	Header_ Trade Settlement. Subtotal_ Calculated. Trade_ Tax	A tax subtotal calculated for this header trade settlement.	0	unbounded
ASBIE	Header_ Trade Settlement. Specified. Logistics_ Service Charge	A logistics service charge specified for this header trade settlement.	0	unbounded
ASBIE	Header_ Trade Settlement. Specified. Trade_ Payment	Payment terms specified for this header trade settlement.	0	unbounded

ABIE/ BBIE/ ASBIE	Dictionary Entry Name	Definition	Occurrence Min	Occurrence Max
	Terms			
ASBIE	Header_ Trade Settlement. Specified. Trade Settlement Header_ Monetary Summation	The monetary summation totals specified for this header trade settlement.	0	1
ASBIE	Header_ Trade Settlement. Specified. Financial_ Adjustment	A financial adjustment specified for this header trade settlement.	0	unbounded
ASBIE	Header_ Trade Settlement. Invoice. Referenced_ Document	The invoice document referenced by this header trade settlement.	0	1
ASBIE	Header_ Trade Settlement. Pro-Forma Invoice. Referenced_ Document	The pro-forma invoice document referenced by this header trade settlement.	0	1
ASBIE	Header_ Trade Settlement. Letter Of Credit. Referenced_ Document	The letter of credit document referenced in this header trade settlement.	0	1
ASBIE	Header_ Trade Settlement. Factoring Agreement. Referenced_ Document	A factoring agreement document referenced in this header trade settlement.	0	unbounded
ASBIE	Header_ Trade Settlement. Factoring List. Referenced_ Document	A factoring list document referenced in this header trade settlement.	0	unbounded
ASBIE	Header_ Trade Settlement. Payable_ Specified. Trade_ Accounting Account	A payable accounting account specified for this header trade settlement.	0	unbounded
ASBIE	Header_ Trade Settlement. Receivable_ Specified. Trade_ Accounting Account	A receivable accounting account specified for this header trade settlement.	0	unbounded
ASBIE	Header_ Trade Settlement. Purchase_ Specified. Trade_ Accounting Account	A purchase accounting account specified for this header trade settlement.	0	unbounded
ASBIE	Header_ Trade Settlement. Sales_ Specified. Trade_ Accounting Account	A sales accounting account specified for this header trade settlement.	0	unbounded
ASBIE	Header_ Trade Settlement. Specified. Trade Settlement_ Financial Card	A financial card specified in this header trade settlement.	0	unbounded
ASBIE	Header_ Trade Settlement. Specified. Advance_ Payment	An advance payment specified in this header trade settlement.	0	unbounded
ASBIE	Header_ Trade Settlement. Ultimate_ Payee. Trade_ Party	An ultimate payee party in this header trade settlement.	0	1
ABIE	Legal_ Organization. Details	An organization set up on a legal basis as a business, government body, department, charity, or financial institution.		

ABIE/ BBIE/ ASBIE	Dictionary Entry Name	Definition	Occurrence Min	Occurrence Max
BBIE	Legal_ Organization. Legal Classification. Code	The code specifying the legal classification of this organization, such as Incorporated (Inc), Limited Liability Corporation (LLC) or non-profit.	0	1
BBIE	Legal_ Organization. Name. Text	A name, expressed as text, of this legally set up organization.	0	1
BBIE	Legal_ Organization. Identification. Identifier	A unique identifier for this legally set up organization.	0	1
BBIE	Legal_ Organization. Trading Business Name. Text	The trading business name, expressed as text, of this legally set up organization.	0	1
ASBIE	Legal_ Organization. Postal. Trade_ Address	A postal address for this legally set up organization.	0	1
ASBIE	Legal_ Organization. Authorized. Legal_ Registration	A legal registration authorized for this legally set up organization.	0	unbounded
ABIE	Legal_ Registration. Details	The recording of items or details for a specific legal purpose.		
BBIE	Legal_ Registration. Type. Code	A code specifying the type of this legal registration.	0	1
BBIE	Legal_ Registration. Identification. Identifier	A unique identifier for this legal registration.	0	1
ABIE	Line_ Trade Agreement. Details	The contractual terms of a line trade agreement.		
BBIE	Line_ Trade Agreement. Buyer_ Reference. Text	A buyer reference, expressed as text, for this line trade agreement.	0	1
ASBIE	Line_ Trade Agreement. Buyer_ Requisitioner. Trade_ Party	A party who is a buyer requisitioner in this line trade agreement.	0	unbounded
ASBIE	Line_ Trade Agreement. Applicable. Trade_ Delivery Terms	The terms of delivery applicable to this line trade agreement.	0	1
ASBIE	Line_ Trade Agreement. Seller_ Order. Referenced_ Document	The seller generated order document referenced in this line trade agreement.	0	1
ASBIE	Line_ Trade Agreement. Buyer_ Order. Referenced_ Document	A buyer generated order document referenced in this line trade agreement.	0	1
ASBIE	Line_ Trade Agreement. Quotation. Referenced_ Document	The quotation document referenced in this line trade agreement.	0	1
ASBIE	Line_ Trade Agreement. Contract. Referenced_ Document	A contract document referenced in this line trade agreement.	0	1
ASBIE	Line_ Trade Agreement. Demand Forecast. Referenced_ Document	A demand forecast document referenced in this line trade agreement.	0	1

ABIE/ BBIE/ ASBIE	Dictionary Entry Name	Definition	Occurrence Min	Occurrence Max
ASBIE	Line_ Trade Agreement. Promotional Deal. Referenced_ Document	The promotional deal document referenced in this line trade agreement.	0	1
ASBIE	Line_ Trade Agreement. Additional. Referenced_ Document	An additional document referenced in this line trade agreement.	0	unbounded
ASBIE	Line_ Trade Agreement. Gross Price_ Product. Trade_ Price	A gross product price in this line trade agreement.	0	1
ASBIE	Line_ Trade Agreement. Net Price_ Product. Trade_ Price	A net product price in this line trade agreement.	0	1
ASBIE	Line_ Trade Agreement. Requisitioner. Referenced_ Document	A requisitioner document referenced in this line trade agreement.	0	unbounded
ASBIE	Line_ Trade Agreement. Item_ Seller. Trade_ Party	The item seller party, such as an auction item seller, for this line trade agreement.	0	1
ASBIE	Line_ Trade Agreement. Item_ Buyer. Trade_ Party	The item buyer party, such as an auction item buyer, for this line trade agreement.	0	1
ASBIE	Line_ Trade Agreement. Included. Specified_ Marketplace	A marketplace included in this line trade agreement.	0	1
ABIE	Line_ Trade Delivery. Details	Shipping arrangements and movement of products and or services including despatch and delivery at a line level.		
BBIE	Line_ Trade Delivery. Requested. Quantity	The quantity, at line level, requested for this trade delivery.	0	1
BBIE	Line_ Trade Delivery. Received. Quantity	The quantity, at line level, received for this trade delivery.	0	1
BBIE	Line_ Trade Delivery. Despatched. Quantity	The quantity despatched in this line trade delivery.	0	1
BBIE	Line_ Trade Delivery. Billed. Quantity	The quantity, at line level, billed for in this trade delivery.	0	1
BBIE	Line_ Trade Delivery. Charge Free. Quantity	The quantity, at line level, free of charge, in this trade delivery.	0	1
BBIE	Line_ Trade Delivery. Package. Quantity	The number of packages, at line level, in this trade delivery.	0	1
BBIE	Line_ Trade Delivery. Product_ Unit. Quantity	The number of product units, at line level, in this trade delivery.	0	1
BBIE	Line_ Trade Delivery. Per Package_ Unit. Quantity	The number of units per package, at line level, in this trade delivery.	0	1
BBIE	Line_ Trade Delivery. Net Weight. Measure	The measure, at line level, of the net weight (mass) of this trade delivery.	0	1

ABIE/ BBIE/ ASBIE	Dictionary Entry Name	Definition	Occurrence Min	Occurrence Max
BBIE	Line_ Trade Delivery. Gross Weight. Measure	The measure, at line level, of the gross weight (mass) of this line trade delivery.	0	1
BBIE	Line_ Trade Delivery. Theoretical Weight. Measure	The measure, at line level, of the theoretical weight of this trade delivery.	0	1
ASBIE	Line_ Trade Delivery. Specified. Delivery_ Adjustment	A delivery adjustment, at line level, specified for this trade delivery.	0	unbounded
ASBIE	Line_ Trade Delivery. Included. Supply Chain_ Packaging	Packaging included, at line level, in this trade delivery.	0	unbounded
ASBIE	Line_ Trade Delivery. Related. Supply Chain_ Consignment	A consignment, at line level, related to this line trade delivery.	0	1
ASBIE	Line_ Trade Delivery. Ship To. Trade_ Party	The ship to party, at line level, for this trade delivery.	0	1
ASBIE	Line_ Trade Delivery. Ultimate_ Ship To. Trade_ Party	The ultimate ship to party, at line level, for this trade delivery.	0	1
ASBIE	Line_ Trade Delivery. Ship From. Trade_ Party	The ship from party, at line level, for this trade delivery.	0	1
ASBIE	Line_ Trade Delivery. Actual_ Despatch. Supply Chain_ Event	An actual despatch event, at line level, for this trade delivery.	0	1
ASBIE	Line_ Trade Delivery. Actual_ Pick-Up. Supply Chain_ Event	The actual pick-up event, at line level, for this trade delivery.	0	1
ASBIE	Line_ Trade Delivery. Requested_ Delivery. Supply Chain_ Event	A delivery event, at line level, requested for this trade delivery.	0	1
ASBIE	Line_ Trade Delivery. Actual_ Delivery. Supply Chain_ Event	An actual delivery event, at line level, for this trade delivery.	0	1
ASBIE	Line_ Trade Delivery. Actual_ Receipt. Supply Chain_ Event	The actual receipt event, at line level, for this trade delivery.	0	1
ASBIE	Line_ Trade Delivery. Additional. Referenced_ Document	An additional document, at line level, referenced for this trade delivery.	0	unbounded
ASBIE	Line_ Trade Delivery. Despatch Advice. Referenced_ Document	The despatch advice document, at line level, referenced for this trade delivery.	0	1
ASBIE	Line_ Trade Delivery. Receiving Advice. Referenced_ Document	A receiving advice document, at line level, referenced for this trade delivery.	0	1
ASBIE	Line_ Trade Delivery. Delivery Note. Referenced_ Document	The delivery note document, at line level, referenced for this trade delivery.	0	1
ASBIE	Line_ Trade Delivery. Consumption Report. Referenced_ Document	The consumption report document, at line level, referenced from this trade delivery.	0	1

ABIE/ BBIE/ ASBIE	Dictionary Entry Name	Definition	Occurrence Min	Occurrence Max
ASBIE	Line_ Trade Delivery. Packing List. Referenced_ Document	The packing list document, at line level, referenced for this trade delivery.	0	1
ABIE	Line_ Trade Settlement. Details	The information, at a line level, that enables the reconciliation of a financial transaction with the item(s) that the financial transaction is intended to settle, for example a commercial invoice.		
BBIE	Line_ Trade Settlement. Payment Reference. Text	A payment reference, expressed as text, for this line trade settlement.	0	unbounded
BBIE	Line_ Trade Settlement. Total_ Adjustment. Amount	The monetary value of the total adjustment for this line trade settlement.	0	1
BBIE	Line_ Trade Settlement. Discount. Indicator	The indication of whether or not a discount applies the item in this line trade settlement.	0	1
BBIE	Line_ Trade Settlement. Invoice Issuer_ Reference. Text	The invoice issuer reference, expressed as text, for this line settlement.	0	1
ASBIE	Line_ Trade Settlement. Applicable. Trade_ Tax	A tax applicable to this line trade settlement.	0	unbounded
ASBIE	Line_ Trade Settlement. Billing. Specified_ Period	A billing period specified for this line trade settlement.	0	1
ASBIE	Line_ Trade Settlement. Specified. Trade_ Allowance Charge	An allowance or charge specified for this line trade settlement.	0	unbounded
ASBIE	Line_ Trade Settlement. Subtotal_ Calculated. Trade_ Tax	A tax subtotal calculated for this line trade settlement.	0	unbounded
ASBIE	Line_ Trade Settlement. Specified. Logistics_ Service Charge	A logistics service charge specified for this line trade settlement.	0	unbounded
ASBIE	Line_ Trade Settlement. Specified. Trade_ Payment Terms	Payment terms specified for this line trade settlement.	0	unbounded
ASBIE	Line_ Trade Settlement. Specified. Trade Settlement Line_ Monetary Summation	The monetary summation totals specified for this line trade settlement.	0	1
ASBIE	Line_ Trade Settlement. Specified. Financial_ Adjustment	A financial adjustment specified for this line trade settlement.	0	unbounded
ASBIE	Line_ Trade Settlement. Invoice. Referenced_ Document	The invoice document referenced in this line trade settlement.	0	1
ASBIE	Line_ Trade Settlement. Additional. Referenced_ Document	An additional document referenced in this line trade settlement.	0	unbounded
ASBIE	Line_ Trade Settlement. Payable_ Specified. Trade_ Accounting Account	A payable accounting account specified for this line trade settlement.	0	unbounded

ABIE/ BBIE/ ASBIE	Dictionary Entry Name	Definition	Occurrence Min	Occurrence Max
ASBIE	Line_ Trade Settlement. Receivable_ Specified. Trade_ Accounting Account	A receivable accounting account specified for this line trade settlement.	0	unbounded
ASBIE	Line_ Trade Settlement. Purchase_ Specified. Trade_ Accounting Account	A purchase accounting account specified for this line trade settlement.	0	unbounded
ASBIE	Line_ Trade Settlement. Sales_ Specified. Trade_ Accounting Account	A sales accounting account specified for this line trade settlement.	0	unbounded
ASBIE	Line_ Trade Settlement. Specified. Trade Settlement_ Financial Card	A financial card specified in this line trade settlement.	0	1
ABIE	Logistics_ Location. Details	A logistics related physical location or place.		
BBIE	Logistics_ Location. Identification. Identifier	A unique identifier for this logistics related location, such as a United Nations Location Code (UNLOCODE) or GS1 Global Location Number (GLN).	0	1
BBIE	Logistics_ Location. Name. Text	A name, expressed as text, of this logistics related location.	0	unbounded
BBIE	Logistics_ Location. Type. Code	A code specifying the type of this logistics related location.	0	1
BBIE	Logistics_ Location. Description. Text	A textual description of this logistics related location.	0	unbounded
ASBIE	Logistics_ Location. Physical. Geographical Coordinate	Geographical coordinate information for this logistics related location.	0	1
ASBIE	Logistics_ Location. Postal. Trade_ Address	The postal trade address information for this logistics related location.	0	1
ABIE	Logistics_ Service Charge. Details	A charge made for a logistics related service.		
BBIE	Logistics_ Service Charge. Identification. Identifier	The unique identifier for this logistics service charge.	0	1
BBIE	Logistics_ Service Charge. Description. Text	A textual description of this logistics service charge.	0	unbounded
BBIE	Logistics_ Service Charge. Payment Arrangement. Code	The code specifying the payment arrangement for this logistics service charge [Reference United Nations Code List (UNCL) 4237].	0	1
BBIE	Logistics_ Service Charge. Tariff Class. Code	The code specifying the tariff class for this logistics service charge which represents an entry in a table of fixed charges [Reference United Nations Code List (UNCL) 5243].	0	1
BBIE	Logistics_ Service Charge. Charge_ Category. Code	The code specifying the category of charge for this logistics service charge.	0	1

ABIE/ BBIE/ ASBIE	Dictionary Entry Name	Definition	Occurrence Min	Occurrence Max
BBIE	Logistics_ Service Charge. Service_ Category. Code	The code specifying the category of service for this logistics service charge.	0	1
BBIE	Logistics_ Service Charge. Disbursement. Amount	A monetary value of a disbursement for this logistics service charge.	0	unbounded
BBIE	Logistics_ Service Charge. Applied. Amount	A monetary value applied to this logistics service charge.	0	unbounded
BBIE	Logistics_ Service Charge. Allowance Charge. Text	The allowance or charge, expressed as text, for this logistics service charge.	0	1
BBIE	Logistics_ Service Charge. Paying Party Role. Code	The code specifying the role of the party responsible for paying this logistics service charge.	0	1
BBIE	Logistics_ Service Charge. Calculation Basis. Code	The code specifying a basis on which this logistics service charge is to be calculated, such as by volume or per unit.	0	1
BBIE	Logistics_ Service Charge. Calculation Basis. Text	The basis, expressed as text, on which this logistics service charge is to be calculated, such as by volume or per unit.	0	1
BBIE	Logistics_ Service Charge. Transport Payment Method. Code	The code specifying the transport payment method for this logistics service charge.	0	1
ASBIE	Logistics_ Service Charge. Payment Place. Logistics_ Location	The location of the place of payment of this logistics service charge.	0	1
ASBIE	Logistics_ Service Charge. Applied From. Logistics_ Location	The start location from which this logistics service charge should be applied.	0	1
ASBIE	Logistics_ Service Charge. Applied To. Logistics_ Location	The end location at which this logistics service charge is no longer to be applied.	0	1
ASBIE	Logistics_ Service Charge. Applied. Trade_ Tax	A tax that is applied to this logistics service charge.	0	unbounded
ABIE	Logistics_ Transport Equipment. Details	A piece of equipment used to hold, protect or secure cargo for logistics purposes.		
BBIE	Logistics_ Transport Equipment. Identification. Identifier	The unique identifier of this piece of logistics transport equipment.	0	1
BBIE	Logistics_ Transport Equipment. Loading Length. Measure	The measure of the loading length of this piece of logistics transport equipment.	0	1
BBIE	Logistics_ Transport Equipment. Category. Code	The code specifying the category for this piece of logistics transport equipment, such as container or trailer.	0	1

ABIE/ BBIE/ ASBIE	Dictionary Entry Name	Definition	Occurrence Min	Occurrence Max
BBIE	Logistics_ Transport Equipment. Characteristic. Code	The code specifying the characteristic or characteristics of this piece of logistics transport equipment, such as the ISO 6346 transport equipment size and type code.	0	1
BBIE	Logistics_ Transport Equipment. Used Capacity. Code	The code specifying the used capacity of this piece of logistics transport equipment, such as full or empty.	0	1
ASBIE	Logistics_ Transport Equipment. Linear. Spatial_ Dimension	The linear spatial dimensions of this piece of logistics transport equipment.	0	1
ABIE	Logistics_ Transport Means. Details	The devices used to convey goods or other objects from place to place during logistics cargo movements.		
BBIE	Logistics_ Transport Means. Type. Code	The code specifying the type of logistics means of transport (Reference UNECE Recommendation 28).	0	1
BBIE	Logistics_ Transport Means. Type. Text	The type, expressed as text, of this logistics means of transport.	0	1
BBIE	Logistics_ Transport Means. Identification. Identifier	An identifier of this logistics means of transport, such as the International Maritime Organization number of a vessel.	0	1
BBIE	Logistics_ Transport Means. Name. Text	The name, expressed as text, of this logistics means of transport.	0	1
ASBIE	Logistics_ Transport Means. Owner. Trade_ Party	The party owning this logistics means of transport.	0	1
ABIE	Logistics_ Transport Movement. Details	The conveyance (physical carriage) of goods or other objects used for logistics transport purposes.		
BBIE	Logistics_ Transport Movement. Stage. Code	The code specifying the stage of this logistics transport movement.	0	1
BBIE	Logistics_ Transport Movement. Mode. Code	The code specifying the mode, such as by air, sea, rail, road or inland waterway, for this logistics transport movement.	0	1
BBIE	Logistics_ Transport Movement. Mode. Text	The mode, expressed as text, of this logistics transport movement.	0	1
ASBIE	Logistics_ Transport Movement. Used. Logistics_ Transport Means	The means of transport used for this logistics transport movement.	0	1

ABIE/ BBIE/ ASBIE	Dictionary Entry Name	Definition	Occurrence Min	Occurrence Max
ABIE	Material_ Goods Characteristic. Details	A distinctive feature of a material contained within physical goods.		
BBIE	Material_ Goods Characteristic. Description. Text	A textual description of this material goods characteristic.	0	unbounded
BBIE	Material_ Goods Characteristic. Type. Code	The code specifying the type of material goods characteristic.	0	1
BBIE	Material_ Goods Characteristic. Proportional_ Constituent. Percent	The percentage presence of the material within the goods for this material goods characteristic.	0	1
BBIE	Material_ Goods Characteristic. Absolute Presence_ Weight. Measure	The weight measure of the absolute presence of this material goods characteristic.	0	1
BBIE	Material_ Goods Characteristic. Absolute Presence_ Volume. Measure	The volume measure of the absolute presence of this material goods characteristic.	0	1
ABIE	Note. Details	A textual or coded description, such as a remark or additional information.		
BBIE	Note. Subject. Text	The subject, expressed as text, of this note.	0	1
BBIE	Note. Content. Code	A code specifying the content of this note.	0	1
BBIE	Note. Content. Text	A content, expressed as text, of this note.	0	unbounded
BBIE	Note. Subject. Code	The code specifying the subject of this note.	0	1
BBIE	Note. Identification. Identifier	A unique identifier for this note.	0	1
ABIE	Packaging_ Marking. Details	An inscription, stamp or label on packaging, such as to indicate date, ownership, quality, manufacture or origin.		
BBIE	Packaging_ Marking. Type. Code	A code specifying a type of packaging marking.	0	unbounded
BBIE	Packaging_ Marking. Content. Text	Content, expressed as text, of this packaging marking.	0	unbounded
BBIE	Packaging_ Marking. Content. Date Time	The date, time, date time or other date time value for the content of this packaging marking.	0	1
BBIE	Packaging_ Marking. Content. Amount	Content, expressed as a monetary amount, for this packaging marking.	0	unbounded
BBIE	Packaging_ Marking. Barcode_ Type. Code	A code specifying a type of barcode for this packaging marking.	0	unbounded
BBIE	Packaging_ Marking. Content. Code	Content, expressed as a code, of this packaging marking.	0	unbounded

ABIE/ BBIE/ ASBIE	Dictionary Entry Name	Definition	Occurrence Min	Occurrence Max
BBIE	Packaging_ Marking. Automatic Data Capture Method_ Type. Code	A code specifying an automatic data capture method type for this packaging marking.	0	unbounded
ABIE	Procuring_ Project. Details	An endeavour carefully planned to achieve a procurement of goods, works and service.		
BBIE	Procuring_ Project. Identification. Identifier	The unique identifier of this procuring project.	1	1
BBIE	Procuring_ Project. Description. Text	The textual description of this procuring project.	0	1
BBIE	Procuring_ Project. Name. Text	The name, expressed as text, of this procuring project.	1	1
ABIE	Product Characteristic_ Condition. Details	A state that applies to a product characteristic.		
BBIE	Product Characteristic_ Condition. Type. Code	The code specifying the type of product characteristic condition.	0	1
BBIE	Product Characteristic_ Condition. Name. Text	A name, expressed as text, for this product characteristic condition.	0	unbounded
BBIE	Product Characteristic_ Condition. Value. Measure	The measure of the value for this product characteristic condition.	0	1
ABIE	Product_ Characteristic. Details	A prominent attribute or aspect of a product.		
BBIE	Product_ Characteristic. Identification. Identifier	A unique identifier for this product characteristic.	0	unbounded
BBIE	Product_ Characteristic. Type. Code	A code specifying a type of product characteristic.	0	1
BBIE	Product_ Characteristic. Description. Text	A textual description of this product characteristic.	0	unbounded
BBIE	Product_ Characteristic. Value. Measure	A measure of a value for this product characteristic.	0	1
BBIE	Product_ Characteristic. Measurement Method. Code	A code specifying a measurement method for this product characteristic.	0	1
BBIE	Product_ Characteristic. Value. Text	A value, expressed as text, for this product characteristic.	0	unbounded
BBIE	Product_ Characteristic. Value. Code	The code specifying the value of this product characteristic.	0	1
BBIE	Product_ Characteristic. Value. Date Time	The value for this product characteristic expressed as a date, time, date time, or other date time value.	0	1
BBIE	Product_ Characteristic. Value. Indicator	The value for this product characteristic expressed as an indicator.	0	1
BBIE	Product_ Characteristic. Content_ Type. Code	The code specifying the content type of this product characteristic.	0	1

ABIE/ BBIE/ ASBIE	Dictionary Entry Name	Definition	Occurrence Min	Occurrence Max
ASBIE	Product_ Characteristic. Value. Specified_ Binary File	The value for this product characteristic expressed in a binary file.	0	1
ASBIE	Product_ Characteristic. Applicable. Product Characteristic_ Condition	A condition applicable to this product characteristic.	0	unbounded
ASBIE	Product_ Characteristic. Applicable. Referenced_ Standard	The referenced standard that is applicable to this product characteristic.	0	1
ABIE	Product_ Classification. Details	A systematic arrangement of products in classes or categories according to established criteria.		
BBIE	Product_ Classification. System. Identifier	The unique identifier of the classification system for this product classification.	0	1
BBIE	Product_ Classification. System Name. Text	A name, expressed as text, of the classification system for this product classification.	0	unbounded
BBIE	Product_ Classification. Class. Code	The code specifying the class for this product classification.	0	1
BBIE	Product_ Classification. Class Name. Text	A class name, expressed as text, for this product classification.	0	unbounded
BBIE	Product_ Classification. Sub_ Class. Code	The code specifying the sub class for this product classification.	0	1
ASBIE	Product_ Classification. Class. Product_ Characteristic	A product class characteristic for this product classification.	0	unbounded
ASBIE	Product_ Classification. Applicable. Referenced_ Standard	The referenced standard that is applicable to this product classification.	0	1
ABIE	Recorded_ Status. Details	Recorded information relevant to a condition or a position of an object.		
BBIE	Recorded_ Status. Condition. Code	The code specifying the condition for this recorded status.	1	1
BBIE	Recorded_ Status. Changer Name. Text	The name of the person or system, expressed as text, that changed this recorded status.	0	1
BBIE	Recorded_ Status. Changed. Date Time	The date, time, date time, or other date time value when this recorded status changed.	1	1
ABIE	Referenced_ Document. Details	Written, printed or electronic matter that is referenced.		
BBIE	Referenced_ Document. Issuer Assigned_ Identification. Identifier	The unique issuer assigned identifier for this referenced document.	0	1
BBIE	Referenced_ Document. URI_ Identification. Identifier	The unique Uniform Resource Identifier (URI) for this referenced document.	0	1

ABIE/ BBIE/ ASBIE	Dictionary Entry Name	Definition	Occurrence Min	Occurrence Max
BBIE	Referenced_ Document. Issue. Date Time	The date or date time for the issuance of this referenced document.	0	1
BBIE	Referenced_ Document. Status. Code	The code specifying the status for this referenced document.	0	1
BBIE	Referenced_ Document. Copy. Indicator	The indication of whether or not the referenced document is a copy.	0	1
BBIE	Referenced_ Document. Line. Identifier	The unique identifier of a line in this referenced document.	0	1
BBIE	Referenced_ Document. Type. Code	The code specifying the type of referenced document.	0	1
BBIE	Referenced_ Document. Global_ Identification. Identifier	A unique global identifier for this referenced document.	0	1
BBIE	Referenced_ Document. Revision_ Identification. Identifier	A unique identifier for a revision of this referenced document.	0	1
BBIE	Referenced_ Document. Name. Text	A name, expressed as text, for this referenced document.	0	unbounded
BBIE	Referenced_ Document. Attachment. Binary Object	A binary object that is attached or otherwise appended to this referenced document.	0	unbounded
BBIE	Referenced_ Document. Information. Text	Information, expressed as text, for this referenced document.	0	unbounded
BBIE	Referenced_ Document. Reference_ Type. Code	The code specifying the reference type of this referenced document.	0	1
BBIE	Referenced_ Document. Section Name. Text	A section name, expressed as text, for this referenced document.	0	unbounded
BBIE	Referenced_ Document. Previous Revision_ Identification. Identifier	An identifier for a previous revision of this referenced document.	0	unbounded
BBIE	Referenced_ Document. Formatted_ Issue. Date Time	The formatted date or date time for the issuance of this referenced document.	0	1
ASBIE	Referenced_ Document. Effective. Specified_ Period	The specified period within which this referenced document is effective.	0	1
ASBIE	Referenced_ Document. Issuer. Trade_ Party	The trade related party that issues this referenced document.	0	1
ASBIE	Referenced_ Document. Attached. Specified_ Binary File	A specified binary file attached to this referenced document.	0	unbounded
ABIE	Referenced_ Product. Details	A reference to a product or service produced by human or mechanical effort or by a natural process for trading purposes.		

ABIE/ BBIE/ ASBIE	Dictionary Entry Name	Definition	Occurrence Min	Occurrence Max
BBIE	Referenced_ Product. Identification. Identifier	A unique identifier for this referenced product.	0	unbounded
BBIE	Referenced_ Product. Global_ Identification. Identifier	A unique global identifier for this referenced product.	0	unbounded
BBIE	Referenced_ Product. Seller Assigned_ Identification. Identifier	The unique seller assigned identifier for this referenced product.	0	1
BBIE	Referenced_ Product. Buyer Assigned_ Identification. Identifier	The unique buyer assigned identifier for this referenced product.	0	1
BBIE	Referenced_ Product. Manufacturer Assigned_ Identification. Identifier	A unique manufacturer assigned identifier for this referenced product.	0	unbounded
BBIE	Referenced_ Product. Industry Assigned_ Identification. Identifier	A unique industry assigned identifier for this referenced product.	0	unbounded
BBIE	Referenced_ Product. Name. Text	A name, expressed as text, for this referenced product.	0	unbounded
BBIE	Referenced_ Product. Description. Text	A textual description for this referenced product.	0	unbounded
BBIE	Referenced_ Product. Relationship_ Type. Code	A code specifying a type of relationship for this referenced product.	0	unbounded
BBIE	Referenced_ Product. Unit. Quantity	A unit quantity of this referenced product.	0	unbounded
ABIE	Referenced_ Standard. Details	A referenced norm or requirement that establishes uniform criteria, methods, processes and practices, such as in engineering or technical areas.		
BBIE	Referenced_ Standard. Identification. Identifier	The identifier of this referenced standard.	0	1
BBIE	Referenced_ Standard. Version. Identifier	The identifier of the version of this referenced standard.	0	1
BBIE	Referenced_ Standard. Element Version. Identifier	The identifier of the version of a specific element within the referenced standard, such as the version of a data element.	0	1
BBIE	Referenced_ Standard. URI. Identifier	The Uniform Resource Identifier (URI) for this referenced standard.	0	1
BBIE	Referenced_ Standard. Part_ Identification. Identifier	The identifier of a part of this referenced standard, such as a section or topic.	0	1
BBIE	Referenced_ Standard. Agency. Identifier	The identifier of the agency for this referenced standard.	0	1
ABIE	Reference_ Price. Details	A reference to a sum of money for which something is or may be bought or sold.		

ABIE/ BBIE/ ASBIE	Dictionary Entry Name	Definition	Occurrence Min	Occurrence Max
BBIE	Reference_ Price. Charge. Amount	The monetary value of a charged reference price.	0	1
BBIE	Reference_ Price. Basis. Quantity	A quantity on which the reference price is based.	0	unbounded
BBIE	Reference_ Price. Net Price. Indicator	An indication of whether or not the reference price is a net price.	0	unbounded
BBIE	Reference_ Price. Comparison Method. Code	The code specifying the comparison method for this reference price.	0	1
ABIE	Registered_ Tax. Details	A registered tax or duty system pertaining to an authority.		
BBIE	Registered_ Tax. Type. Code	The code specifying the type of registered tax.	0	1
BBIE	Registered_ Tax. Exemption Reason. Code	The code specifying the exemption reason for this registered tax.	0	1
BBIE	Registered_ Tax. Exemption Reason. Text	A reason, expressed as text, for exemption from this registered tax.	0	unbounded
BBIE	Registered_ Tax. Currency. Code	The code specifying the currency for this registered tax.	0	1
BBIE	Registered_ Tax. Jurisdiction. Text	A jurisdiction, expressed as text, for this registered tax.	0	unbounded
BBIE	Registered_ Tax. Description. Text	A textual description of this registered tax.	0	unbounded
BBIE	Registered_ Tax. Customs Duty. Indicator	The indication of whether or not this registered tax is a customs duty.	0	1
ABIE	Returnable Asset_ Instructions. Details	The procedures to follow for returnable assets, such as reusable packaging (pallets, crates).		
BBIE	Returnable Asset_ Instructions. Material. Identifier	An identifier of the material to which these returnable asset instructions apply.	0	unbounded
BBIE	Returnable Asset_ Instructions. Terms And Conditions_ Description. Text	A textual description of the terms and conditions for these returnable asset instructions.	0	unbounded
BBIE	Returnable Asset_ Instructions. Terms And Conditions_ Description. Code	The code specifying the description of the terms and conditions for these returnable asset instructions.	0	1
BBIE	Returnable Asset_ Instructions. Deposit Value_ Specified. Amount	A deposit value specified in these returnable asset instructions.	0	unbounded
ASBIE	Returnable Asset_ Instructions. Deposit Value_ Validity. Specified_ Period	The specified period during which the deposit value specified in these returnable asset instructions is valid.	0	1

ABIE/ BBIE/ ASBIE	Dictionary Entry Name	Definition	Occurrence Min	Occurrence Max
ABIE	Spatial_ Dimension. Details	A measure of spatial extent of an object, such as the length, breadth or height of a shipping container.		
BBIE	Spatial_ Dimension. Value. Measure	The measure of the value of this spatial dimension.	0	1
BBIE	Spatial_ Dimension. Type. Code	The code specifying the type of spatial dimension, such as thickness, area, or volume.	0	1
BBIE	Spatial_ Dimension. Description. Text	A textual description of this spatial dimension.	0	unbounded
BBIE	Spatial_ Dimension. Width. Measure	The measure of the width component of this spatial dimension.	0	1
BBIE	Spatial_ Dimension. Length. Measure	The measure of the length component of this spatial dimension.	0	1
BBIE	Spatial_ Dimension. Height. Measure	The measure of the height component of this spatial dimension.	0	1
BBIE	Spatial_ Dimension. Identification. Identifier	The unique identifier of this spatial dimension.	0	1
BBIE	Spatial_ Dimension. Diameter. Measure	The measure of the diameter component for this spatial dimension.	0	1
ABIE	Specification_ Query. Details	A formally raised question or request for information about this specification.		
BBIE	Specification_ Query. Identification. Identifier	The unique identifier for this specification query.	1	1
BBIE	Specification_ Query. Type. Code	The code specifying the type of specification query.	0	1
BBIE	Specification_ Query. Content. Text	The content, expressed as text, of this specification query.	1	1
BBIE	Specification_ Query. Contractual Language. Code	The code specifying the contractual language for this specification query.	0	1
ABIE	Specification_ Response. Details	A response to a specification query.		
BBIE	Specification_ Response. Identification. Identifier	The unique identifier for this specification response.	1	1
BBIE	Specification_ Response. Query_ Identification. Identifier	The unique identifier for the query to which this response refers.	0	1
BBIE	Specification_ Response. Type. Code	The code specifying the type of this specification response.	0	1
BBIE	Specification_ Response. Content. Text	The content, expressed as text, of this specification response.	1	1

ABIE/ BBIE/ ASBIE	Dictionary Entry Name	Definition	Occurrence Min	Occurrence Max
BBIE	Specification_ Response. Contractual Language. Code	The code specifying the contractual language for this specification response.	0	1
ABIE	Specified_ Binary File. Details	A specified computer file or program stored in a binary format.		
BBIE	Specified_ Binary File. Identification. Identifier	A unique identifier for this specified binary file.	0	unbounded
BBIE	Specified_ Binary File. Title. Text	A title, expressed as text, for this specified binary file.	0	unbounded
BBIE	Specified_ Binary File. Author Name. Text	A name of an author, expressed as text, of this specified binary file.	0	unbounded
BBIE	Specified_ Binary File. Version. Identifier	The unique version identifier for this specified binary file.	0	1
BBIE	Specified_ Binary File. File Name. Text	The file name, expressed as text, of this specified binary file.	0	1
BBIE	Specified_ Binary File. URI. Identifier	The unique Uniform Resource Identifier (URI) for this specified binary file.	0	1
BBIE	Specified_ Binary File. MIME. Code	The code specifying the Multipurpose Internet Mail Extensions (MIME) type for this specified binary file.	0	1
BBIE	Specified_ Binary File. Encoding. Code	The code specifying the encoding of this specified binary file.	0	1
BBIE	Specified_ Binary File. Character Set. Code	The code specifying the character set for this specified binary file.	0	1
BBIE	Specified_ Binary File. Included. Binary Object	A binary object included in this specified binary file.	0	unbounded
BBIE	Specified_ Binary File. Access. Text	Access information, expressed as text, for this specified binary file, such as security and download parameters.	0	unbounded
BBIE	Specified_ Binary File. Description. Text	A textual description of this specified binary file.	0	unbounded
BBIE	Specified_ Binary File. Size. Measure	The measure of the size of this specified binary file.	0	1
ASBIE	Specified_ Binary File. Access Availability. Specified_ Period	The specified period when access to this binary file is available.	0	1
ABIE	Specified_ Marketplace. Details	An actual or virtual place where buyers and sellers interact, directly or through intermediaries, to trade goods or services.		
BBIE	Specified_ Marketplace. Identification. Identifier	The identifier for this specified marketplace.	0	1

ABIE/ BBIE/ ASBIE	Dictionary Entry Name	Definition	Occurrence Min	Occurrence Max
BBIE	Specified_ Marketplace. Name. Text	The name, expressed as text, for this specified marketplace.	0	1
BBIE	Specified_ Marketplace. Virtual. Indicator	The indication of whether or not this specified marketplace is virtual, such as a web-based marketplace.	0	1
BBIE	Specified_ Marketplace. Website_ URI. Identifier	A website Uniform Resource Identifier (URI) for this specified marketplace.	0	unbounded
BBIE	Specified_ Marketplace. Sales Method. Code	The code specifying a sales method, such as an auction clock or mediation, for this specified marketplace.	0	1
ASBIE	Specified_ Marketplace. Ordering. Available_ Period	An available ordering period for this specified marketplace.	0	unbounded
ABIE	Specified_ Period. Details	A specified period of time.		
BBIE	Specified_ Period. Duration. Measure	A measure of the length of time for this specified time period such as hours, days, weeks, months, years.	0	unbounded
BBIE	Specified_ Period. Inclusive. Indicator	The indication of whether or not the start and end dates are included in this specified period.	0	1
BBIE	Specified_ Period. Description. Text	A textual description of this specified period of time.	0	unbounded
BBIE	Specified_ Period. Start. Date Time	The date, time, date time or other date time value for the start of this specified period of time.	0	1
BBIE	Specified_ Period. End. Date Time	The date, time, date time or other date time value for the end of this specified period of time.	0	1
BBIE	Specified_ Period. Complete. Date Time	The date, time, date time or other date time value for a complete specified period of time expressed as a specific month, a specific week, etc.	0	1
BBIE	Specified_ Period. Open. Indicator	The indication of whether or not an entity is open during this specified period.	0	1
BBIE	Specified_ Period. Season. Code	The code specifying the season for this specified period.	0	1
BBIE	Specified_ Period. Identification. Identifier	The unique identifier of this specified period.	0	1
BBIE	Specified_ Period. Name. Text	A name, expressed as text, of this specified period.	0	unbounded
BBIE	Specified_ Period. Sequence. Numeric	A sequence number for this specified period.	0	1

ABIE/ BBIE/ ASBIE	Dictionary Entry Name	Definition	Occurrence Min	Occurrence Max
BBIE	Specified_Period. Start Date Flexibility. Code	The code specifying the flexibility of the start date of this specified period.	0	1
BBIE	Specified_Period. Continuous. Indicator	The indication of whether or not this specified period is continuous.	0	1
BBIE	Specified_Period. Purpose. Code	The code specifying the purpose of this specified period.	0	1
ABIE	Subordinate Line_ Trade Agreement. Details	The contractual terms of a subordinate line trade agreement.		
ASBIE	Subordinate Line_ Trade Agreement. Seller_ Order. Referenced_ Document	The seller generated order document referenced in this subordinate line trade agreement.	0	1
ASBIE	Subordinate Line_ Trade Agreement. Buyer_ Order. Referenced_ Document	A buyer generated order document referenced in this subordinate line trade agreement.	0	1
ASBIE	Subordinate Line_ Trade Agreement. Additional. Referenced_ Document	An additional document referenced in this subordinate line trade agreement.	0	unbounded
ASBIE	Subordinate Line_ Trade Agreement. Gross Price_ Product. Trade_ Price	A gross product price in this subordinate line trade agreement.	0	unbounded
ASBIE	Subordinate Line_ Trade Agreement. Net Price_ Product. Trade_ Price	A net product price in this subordinate line trade agreement.	0	unbounded
ABIE	Subordinate Line_ Trade Delivery. Details	Supply chain shipping arrangements and movement of products and or services including despatch and delivery.		
BBIE	Subordinate Line_ Trade Delivery. Package. Quantity	The number of packages in this subordinate line trade delivery.	0	1
BBIE	Subordinate Line_ Trade Delivery. Product_ Unit. Quantity	The number of product units in this subordinate line trade delivery.	0	1
BBIE	Subordinate Line_ Trade Delivery. Per Package_ Unit. Quantity	The number of units per package in this subordinate line trade delivery.	0	1
ASBIE	Subordinate Line_ Trade Delivery. Included. Supply Chain_ Packaging	Packaging included in this subordinate line trade delivery.	0	unbounded
ABIE	Subordinate Line_ Trade Settlement. Details	The information, at a subordinate line level, that enables the reconciliation of a financial transaction with the item(s) that the financial transaction is intended to settle, for example a commercial invoice.		

ABIE/ BBIE/ ASBIE	Dictionary Entry Name	Definition	Occurrence Min	Occurrence Max
ASBIE	Subordinate Line_ Trade Settlement. Applicable. Trade_ Tax	A tax applicable to this subordinate line trade settlement.	0	1
ABIE	Subordinate_ Trade Line Item. Details	A collection of information specific to a subordinate item being used or reported on for trade purposes.		
BBIE	Subordinate_ Trade Line Item. Identification. Identifier	An identifier for this subordinate trade line item.	0	unbounded
ASBIE	Subordinate_ Trade Line Item. Specified. Referenced_ Product	The referenced product specified for this subordinate trade line item.	0	1
ASBIE	Subordinate_ Trade Line Item. Applicable. Trade_ Product	A product applicable for this subordinate trade line item.	0	unbounded
ASBIE	Subordinate_ Trade Line Item. Specified. Subordinate Line_ Trade Agreement	The trade agreement specified for this subordinate trade line item.	0	1
ASBIE	Subordinate_ Trade Line Item. Specified. Subordinate Line_ Trade Delivery	The delivery specified for this subordinate trade line item.	0	1
ASBIE	Subordinate_ Trade Line Item. Specified. Subordinate Line_ Trade Settlement	A trade settlement specified for this subordinate trade line item.	0	1
ABIE	Supply Chain_ Consignment Item. Details	An item within a supply chain consignment of goods separately identified for transport and customs purposes.		
BBIE	Supply Chain_ Consignment Item. Type. Code	The code specifying the type of supply chain consignment item.	0	1
BBIE	Supply Chain_ Consignment Item. Type Extension. Code	The code used as an extension to the type code for further specifying the type of supply chain consignment item.	0	1
BBIE	Supply Chain_ Consignment Item. Declared Value For Customs. Amount	The monetary value of this supply chain consignment item as declared for customs purposes.	0	1
BBIE	Supply Chain_ Consignment Item. Declared Value For Statistics. Amount	The monetary value of this supply chain consignment item as declared for statistical purposes.	0	1
BBIE	Supply Chain_ Consignment Item. Invoice. Amount	A monetary value for an invoice for this supply chain consignment item.	0	unbounded
BBIE	Supply Chain_ Consignment Item. Gross Weight. Measure	A measure of the gross weight (mass) of this supply chain consignment item which includes packaging but excludes any transport equipment.	0	1

ABIE/ BBIE/ ASBIE	Dictionary Entry Name	Definition	Occurrence Min	Occurrence Max
BBIE	Supply Chain_ Consignment Item. Net Weight. Measure	A measure of the net weight (mass) of this supply chain consignment item which excludes all packaging.	0	1
BBIE	Supply Chain_ Consignment Item. Tariff. Quantity	The tariff quantity in this supply chain consignment item.	0	1
ASBIE	Supply Chain_ Consignment Item. Nature Identification. Transport_ Cargo	Transport cargo details of this supply chain consignment item sufficient to identify its nature for customs, statistical or transport purposes.	0	1
ABIE	Supply Chain_ Consignment. Details	A separately identifiable collection of goods items to be transported or available to be transported from one consignor to one consignee in a supply chain via one or more modes of transport where each consignment is the subject of one single transport contract.		
BBIE	Supply Chain_ Consignment. Gross Weight. Measure	A measure of the gross weight (mass) of this supply chain consignment which includes the weight of packaging but which excludes the weight of any transport equipment.	0	unbounded
BBIE	Supply Chain_ Consignment. Net Weight. Measure	A measure of the net weight (mass) of this consignment which excludes the weight of packaging of this supply chain consignment and that of any transport equipment.	0	unbounded
BBIE	Supply Chain_ Consignment. Gross Volume. Measure	A measure of the gross volume, normally calculated by multiplying the maximum length, width and height of this supply chain consignment.	0	unbounded
BBIE	Supply Chain_ Consignment. Insurance Premium. Amount	The monetary value of the insurance premium for this supply chain consignment.	0	1
BBIE	Supply Chain_ Consignment. Associated Invoice. Amount	A monetary value of an invoice associated with this supply chain consignment.	0	unbounded
BBIE	Supply Chain_ Consignment. Total Charge. Amount	The total monetary value of all freight and other service charges for this supply chain consignment.	0	1
BBIE	Supply Chain_ Consignment. Declared Value For Customs. Amount	The monetary value declared for customs purposes for this supply chain consignment.	0	1

ABIE/ BBIE/ ASBIE	Dictionary Entry Name	Definition	Occurrence Min	Occurrence Max
BBIE	Supply Chain_ Consignment. Package. Quantity	The number of packages within this supply chain consignment.	0	1
ASBIE	Supply Chain_ Consignment. Consignor. Trade_ Party	The consignor party for this supply chain consignment.	0	1
ASBIE	Supply Chain_ Consignment. Consignee. Trade_ Party	The consignee party for this supply chain consignment.	0	1
ASBIE	Supply Chain_ Consignment. Carrier. Trade_ Party	The carrier party for this supply chain consignment.	0	1
ASBIE	Supply Chain_ Consignment. Freight Forwarder. Trade_ Party	The freight forwarder party for this supply chain consignment.	0	1
ASBIE	Supply Chain_ Consignment. Delivery. Trade_ Party	The party to whom this supply chain consignment will be, or has been, delivered.	0	1
ASBIE	Supply Chain_ Consignment. Customs Import Agent. Trade_ Party	The party acting as an agent for, or on behalf of, the consignee with respect to the customs import procedures for this supply chain consignment.	0	1
ASBIE	Supply Chain_ Consignment. Customs Export Agent. Trade_ Party	The party acting as an agent for, or on behalf of, the consignor with respect to the customs export procedures for this supply chain consignment.	0	1
ASBIE	Supply Chain_ Consignment. Grouping Centre. Trade_ Party	A grouping centre party for this supply chain consignment.	0	unbounded
ASBIE	Supply Chain_ Consignment. Transport Contract. Referenced_ Document	The referenced transport contract document for this supply chain consignment, such as an airwaybill or a seawaybill.	0	1
ASBIE	Supply Chain_ Consignment. Associated. Referenced_ Document	A referenced document associated with this supply chain consignment, such as the certificate of origin or dangerous goods note.	0	unbounded
ASBIE	Supply Chain_ Consignment. Included. Supply Chain_ Consignment Item	A consignment item included in this supply chain consignment.	0	unbounded
ASBIE	Supply Chain_ Consignment. Utilized. Logistics_ Transport Equipment	Logistics transport equipment utilized for this supply chain consignment.	0	unbounded
ASBIE	Supply Chain_ Consignment. Specified. Logistics_ Transport Movement	A logistics transport movement specified for this supply chain consignment.	0	unbounded
ABIE	Supply Chain_ Event. Details	A significant occurrence or happening in a supply chain.		
BBIE	Supply Chain_ Event. Identification. Identifier	The unique identifier for this supply chain event.	0	1

ABIE/ BBIE/ ASBIE	Dictionary Entry Name	Definition	Occurrence Min	Occurrence Max
BBIE	Supply Chain_ Event. Occurrence. Date Time	A date, time, date time, or other date time value of an occurrence of this supply chain event.	0	1
BBIE	Supply Chain_ Event. Type. Code	A code specifying the type of supply chain event.	0	1
BBIE	Supply Chain_ Event. Description. Text	A textual description of this supply chain event.	0	unbounded
BBIE	Supply Chain_ Event. Description. Binary Object	Binary object data, such as a photograph, describing this supply chain event.	0	unbounded
BBIE	Supply Chain_ Event. Unit. Quantity	A number of units for this supply chain event.	0	1
BBIE	Supply Chain_ Event. Latest Occurrence. Date Time	The date, time, date time, or other date time value of the latest occurrence of this supply chain event.	0	1
BBIE	Supply Chain_ Event. Earliest Occurrence. Date Time	The date, time, date time, or other date time value of the earliest occurrence of this supply chain event.	0	1
ASBIE	Supply Chain_ Event. Occurrence. Specified Period	A specified period of time during which this supply chain event occurs.	0	1
ASBIE	Supply Chain_ Event. Occurrence. Logistics Location	A logistics location where this supply chain event occurs.	0	1
ABIE	Supply Chain_ Packaging. Details	Any material with which supply chain goods are packaged, such as a box or bubble wrap.		
BBIE	Supply Chain_ Packaging. Type. Code	The code specifying the type of supply chain packaging.	0	1
BBIE	Supply Chain_ Packaging. Type. Text	The type, expressed as text, of supply chain packaging.	0	1
BBIE	Supply Chain_ Packaging. Description. Text	A textual description of this supply chain packaging.	0	unbounded
BBIE	Supply Chain_ Packaging. Condition. Code	A code specifying the condition of this supply chain packaging.	0	1
BBIE	Supply Chain_ Packaging. Disposal Method. Code	A code specifying the disposal method of this supply chain packaging.	0	unbounded
BBIE	Supply Chain_ Packaging. Weight. Measure	A measure of the weight of this supply chain packaging.	0	unbounded
BBIE	Supply Chain_ Packaging. Maximum Stackability. Quantity	The number of units of this type of supply chain packaging which can be stacked on top of each other.	0	1
BBIE	Supply Chain_ Packaging. Maximum Stackability Weight. Measure	The measure of the maximum stackability weight of this supply chain packaging.	0	1

ABIE/ BBIE/ ASBIE	Dictionary Entry Name	Definition	Occurrence Min	Occurrence Max
BBIE	Supply Chain_ Packaging. Customer Facing_ Total Unit. Quantity	The total number of units of this supply chain packaging facing the customer, such as would be seen when this packaging is placed on a retail shelf.	0	1
BBIE	Supply Chain_ Packaging. Layer_ Total Unit. Quantity	The total number of units in a layer of this supply chain packaging.	0	1
BBIE	Supply Chain_ Packaging. Content Layer. Quantity	The number of content layers that are or may be packaged with this supply chain packaging, such as the number of layers of product on a pallet.	0	1
ASBIE	Supply Chain_ Packaging. Linear. Spatial_ Dimension	The linear spatial dimensions of this supply chain packaging.	0	1
ASBIE	Supply Chain_ Packaging. Minimum_ Linear. Spatial_ Dimension	The minimum linear spatial dimensions of this supply chain packaging.	0	1
ASBIE	Supply Chain_ Packaging. Maximum_ Linear. Spatial_ Dimension	The maximum linear spatial dimensions of this supply chain packaging.	0	1
ASBIE	Supply Chain_ Packaging. Specified. Packaging_ Marking	A marking specified for this supply chain packaging, such as an inscription, stamp or label to indicate date, ownership, quality, manufacture or origin.	0	unbounded
ASBIE	Supply Chain_ Packaging. Applicable. Material_ Goods Characteristic	Material goods characteristic applicable to this supply chain packaging.	0	unbounded
ASBIE	Supply Chain_ Packaging. Applicable. Disposal_ Instructions	Disposal instructions for this supply chain packaging.	0	unbounded
ASBIE	Supply Chain_ Packaging. Applicable. Returnable Asset_ Instructions	Returnable asset instructions for this supply chain packaging.	0	unbounded
ABIE	Supply Chain_ Trade Line Item. Details	A collection of information specific to an item being used or reported on for supply chain trade purposes.		
BBIE	Supply Chain_ Trade Line Item. Description. Code	The code specifying a description of this supply chain trade line item.	0	1
ASBIE	Supply Chain_ Trade Line Item. Associated. Document Line_ Document	The document line associated with this trade line item.	1	1
ASBIE	Supply Chain_ Trade Line Item. Specified. Trade_ Product	The product specified for this supply chain trade line item.	0	1
ASBIE	Supply Chain_ Trade Line Item. Specified. Line_ Trade Agreement	The line trade agreement specified for this supply chain trade line item.	0	1

ABIE/ BBIE/ ASBIE	Dictionary Entry Name	Definition	Occurrence Min	Occurrence Max
ASBIE	Supply Chain_ Trade Line Item. Specified. Line_ Trade Delivery	The line trade delivery specified for this supply chain trade line item.	0	1
ASBIE	Supply Chain_ Trade Line Item. Specified. Line_ Trade Settlement	A line trade settlement specified for this supply chain trade line item.	1	1
ASBIE	Supply Chain_ Trade Line Item. Included. Subordinate_ Trade Line Item	A subordinate trade line item included in this supply chain trade line item.	0	unbounded
ABIE	Supply Chain_ Trade Transaction. Details	A group of supply chain trade line items, trade agreement, trade delivery and trade settlement details.		
ASBIE	Supply Chain_ Trade Transaction. Included. Supply Chain_ Trade Line Item	A trade line item included in this supply chain trade transaction.	0	unbounded
ASBIE	Supply Chain_ Trade Transaction. Applicable. Header_ Trade Agreement	A trade agreement header applicable to this supply chain trade transaction, such as payment or delivery terms.	1	1
ASBIE	Supply Chain_ Trade Transaction. Applicable. Header_ Trade Delivery	A trade delivery header applicable to this supply chain trade transaction.	1	1
ASBIE	Supply Chain_ Trade Transaction. Applicable. Header_ Trade Settlement	The trade settlement header applicable to this supply chain trade transaction.	1	1
ABIE	Tax_ Registration. Details	Registration with a specific tax authority.		
BBIE	Tax_ Registration. Identification. Identifier	The unique identifier for this tax registration.	0	1
ASBIE	Tax_ Registration. Associated. Registered_ Tax	The registered tax associated with this tax registration.	0	1
ABIE	Trade Settlement Header_ Monetary Summation. Details	A collection of monetary amount totals, specified at header level, for a trade settlement.		
BBIE	Trade Settlement Header_ Monetary Summation. Line Total. Amount	A monetary value of the line amount total being reported in this trade settlement header monetary summation.	0	unbounded
BBIE	Trade Settlement Header_ Monetary Summation. Charge Total. Amount	A monetary value of the total of all charge amounts being reported in this trade settlement header monetary summation.	0	unbounded
BBIE	Trade Settlement Header_ Monetary Summation. Allowance Total. Amount	A monetary value of the total of all allowance amounts being reported in this trade settlement header monetary summation.	0	unbounded

ABIE/ BBIE/ ASBIE	Dictionary Entry Name	Definition	Occurrence Min	Occurrence Max
BBIE	Trade Settlement Header_Monetary Summation. Tax Basis Total. Amount	A monetary value of the total of all tax basis amounts being reported in this trade settlement monetary summation.	0	unbounded
BBIE	Trade Settlement Header_Monetary Summation. Tax Total. Amount	A monetary value of the total of all tax amounts being reported in this trade settlement header monetary summation.	0	unbounded
BBIE	Trade Settlement Header_Monetary Summation. Rounding. Amount	A monetary value of a rounding amount being applied in this trade settlement header monetary summation.	0	unbounded
BBIE	Trade Settlement Header_Monetary Summation. Grand Total. Amount	A monetary value of the grand total of this trade settlement header monetary summation, to include addition and subtraction of individual summation amounts.	0	unbounded
BBIE	Trade Settlement Header_Monetary Summation. Information. Amount	A monetary value of an amount being reported for information in this trade settlement header monetary summation.	0	unbounded
BBIE	Trade Settlement Header_Monetary Summation. Total Prepaid. Amount	A monetary value of a prepaid total reported in this trade settlement header monetary summation.	0	unbounded
BBIE	Trade Settlement Header_Monetary Summation. Total Discount. Amount	A monetary value of a total discount reported in this trade settlement header monetary summation.	0	unbounded
BBIE	Trade Settlement Header_Monetary Summation. Total Allowance Charge. Amount	A monetary value of a total allowance and charge reported in this trade settlement header monetary summation.	0	unbounded
BBIE	Trade Settlement Header_Monetary Summation. Due Payable. Amount	A monetary value that is an amount due and payable for this trade settlement header monetary summation, such as the amount due to the creditor.	0	unbounded
BBIE	Trade Settlement Header_Monetary Summation. Retail Value Excluding Tax_Information. Amount	A monetary value which constitutes the retail value, excluding all duties and taxes, stated for information purposes in this trade settlement header monetary summation.	0	unbounded
BBIE	Trade Settlement Header_Monetary Summation. Total Deposit Fee_Information. Amount	A monetary value of the total deposit fee stated for information purposes in this trade settlement header	0	unbounded

ABIE/ BBIE/ ASBIE	Dictionary Entry Name	Definition	Occurrence Min	Occurrence Max
		monetary summation.		
BBIE	Trade Settlement Header_Monetary Summation. Product Value Excluding Tobacco Tax_ Information. Amount	A monetary value which constitutes the total product value excluding tobacco tax stated for information purposes in this trade settlement header monetary summation.	0	unbounded
BBIE	Trade Settlement Header_Monetary Summation. Total Retail Value_ Information. Amount	A monetary value which constitutes the total retail value stated for information purposes in this trade settlement header monetary summation.	0	unbounded
BBIE	Trade Settlement Header_Monetary Summation. Gross_ Line Total. Amount	A monetary value of the total of all line amounts, excluding line level allowances and charges and taxes, being reported in this trade settlement header monetary summation.	0	unbounded
BBIE	Trade Settlement Header_Monetary Summation. Net_ Line Total. Amount	A monetary value of the total of all line amounts, including line level allowances and charges and excluding line level taxes, being reported in this trade settlement header monetary summation.	0	unbounded
BBIE	Trade Settlement Header_Monetary Summation. Net Including Taxes_ Line Total. Amount	A monetary value of the total of all line amounts, including line level allowances and charges and including line level taxes, being reported in this trade settlement header monetary summation.	0	unbounded
ABIE	Trade Settlement Line_Monetary Summation. Details	A collection of monetary amount totals, specified at line level, for a trade settlement.		
BBIE	Trade Settlement Line_Monetary Summation. Line Total. Amount	A monetary value of the line amount total being reported in this trade settlement line monetary summation.	0	unbounded
BBIE	Trade Settlement Line_Monetary Summation. Charge Total. Amount	A monetary value of the total of all charge amounts being reported in this trade settlement line monetary summation.	0	unbounded
BBIE	Trade Settlement Line_Monetary Summation. Allowance Total. Amount	A monetary value of the total of all allowance amounts being reported in this trade settlement line monetary summation.	0	unbounded

ABIE/ BBIE/ ASBIE	Dictionary Entry Name	Definition	Occurrence Min	Occurrence Max
BBIE	Trade Settlement Line_Monetary Summation. Tax Basis Total. Amount	A monetary value of the total of all tax basis amounts being reported in this trade settlement line monetary summation.	0	unbounded
BBIE	Trade Settlement Line_Monetary Summation. Tax Total. Amount	A monetary value of the total of all tax amounts being reported in this trade settlement line monetary summation.	0	unbounded
BBIE	Trade Settlement Line_Monetary Summation. Grand Total. Amount	A monetary value of the grand total of this trade settlement line monetary summation, to include addition and subtraction of individual summation amounts.	0	1
BBIE	Trade Settlement Line_Monetary Summation. Information. Amount	A monetary value of an amount being reported for information in this trade settlement monetary summation.	0	unbounded
BBIE	Trade Settlement Line_Monetary Summation. Total Allowance Charge. Amount	A monetary value of a total allowance and charge reported in this trade settlement line monetary summation.	0	unbounded
BBIE	Trade Settlement Line_Monetary Summation. Total Retail Value_ Information. Amount	A monetary value which constitutes the total retail value stated for information purposes in this trade settlement line monetary summation.	0	unbounded
BBIE	Trade Settlement Line_Monetary Summation. Gross_Line Total. Amount	A monetary value of the total of all line amounts, excluding line level allowances and charges and taxes, being reported in this trade settlement line monetary summation.	0	unbounded
BBIE	Trade Settlement Line_Monetary Summation. Net_Line Total. Amount	A monetary value of the total of all line amounts, including line level allowances and charges and excluding line level taxes, being reported in this trade settlement line monetary summation.	0	unbounded
BBIE	Trade Settlement Line_Monetary Summation. Net Including Taxes_Line Total. Amount	A monetary value of the total of all line amounts, including line level allowances and charges and including line level taxes, being reported in this trade settlement line monetary summation.	0	unbounded

ABIE/ BBIE/ ASBIE	Dictionary Entry Name	Definition	Occurrence Min	Occurrence Max
BBIE	Trade Settlement Line_ Monetary Summation. Product Weight Loss_ Information. Amount	A monetary value of the loss of weight of a product, such as fresh goods, stated for information purposes in this trade settlement line monetary summation.	0	unbounded
ABIE	Trade Settlement_ Financial Card. Details	A card used to represent a financial account for a trade settlement.		
BBIE	Trade Settlement_ Financial Card. Microchip. Indicator	The indication of whether or not this trade settlement financial card has a microchip.	0	1
BBIE	Trade Settlement_ Financial Card. Identification. Identifier	The unique identifier, commonly known as the card number, of this trade settlement financial card.	0	1
BBIE	Trade Settlement_ Financial Card. Type. Code	The code specifying the type of this trade settlement financial card, such as debit or credit.	0	1
BBIE	Trade Settlement_ Financial Card. Cardholder Name. Text	The cardholder name as it appears on this trade settlement financial card. This may include both an individual authorized to use the card as well as the organization that owns the card.	0	1
BBIE	Trade Settlement_ Financial Card. Expiry. Date	The date of expiry up to which this trade settlement financial card is valid.	0	1
BBIE	Trade Settlement_ Financial Card. Verification. Numeric	The unique card verification number for security purposes to help verify the card user is in actual possession of this trade settlement financial card.	0	1
BBIE	Trade Settlement_ Financial Card. Valid From. Date Time	The date from which this trade settlement financial card is valid.	0	1
BBIE	Trade Settlement_ Financial Card. Credit Limit. Amount	A monetary value of the credit limit for this trade settlement financial card.	0	unbounded
BBIE	Trade Settlement_ Financial Card. Credit Available. Amount	A monetary value of the credit available for this trade settlement financial card.	0	unbounded
BBIE	Trade Settlement_ Financial Card. Interest Rate. Percent	The interest rate expressed as a percentage for this trade settlement financial card.	0	1
BBIE	Trade Settlement_ Financial Card. Issuing Company Name. Text	The issuing company name, expressed as text, for this trade settlement financial card.	0	1
BBIE	Trade Settlement_ Financial Card. Description. Text	The textual description of this trade settlement financial	0	1

ABIE/ BBIE/ ASBIE	Dictionary Entry Name	Definition	Occurrence Min	Occurrence Max
		card.		
ABIE	Trade Settlement_ Payment Means. Details	The means by which a payment will be or has been made for trade settlement purposes.		
BBIE	Trade Settlement_ Payment Means. Payment Channel. Code	The code specifying the payment channel through which this trade settlement payment is to be processed (Reference United Nations Code List (UNCL) 4435).	0	1
BBIE	Trade Settlement_ Payment Means. Type. Code	The code specifying the type of trade settlement payment means, such as cash or check.	0	1
BBIE	Trade Settlement_ Payment Means. Guarantee Method. Code	The code specifying the method of guarantee for this trade settlement payment means.	0	1
BBIE	Trade Settlement_ Payment Means. Payment Method. Code	The code specifying the method by which a payment may be made for this trade settlement payment means.	0	1
BBIE	Trade Settlement_ Payment Means. Information. Text	Information, expressed as text, for this trade settlement payment means.	0	unbounded
BBIE	Trade Settlement_ Payment Means. Identification. Identifier	An identifier for this trade settlement payment means.	0	unbounded
ASBIE	Trade Settlement_ Payment Means. Applicable. Trade Settlement_ Financial Card	A financial card applicable to this trade settlement payment means.	0	1
ASBIE	Trade Settlement_ Payment Means. Payer_ Party. Debtor_ Financial Account	The debtor financial account of the payer party for this trade settlement payment means.	0	1
ASBIE	Trade Settlement_ Payment Means. Payee_ Party. Creditor_ Financial Account	The creditor financial account of the payee party for this trade settlement payment means.	0	1
ASBIE	Trade Settlement_ Payment Means. Payer_ Specified. Debtor_ Financial Institution	The debtor financial institution of the payer party specified for this trade settlement payment means.	0	1
ASBIE	Trade Settlement_ Payment Means. Payee_ Specified. Creditor_ Financial Institution	The creditor financial institution of the payee party specified for this trade settlement payment means.	0	1
ABIE	Trade_ Accounting Account. Details	A specific trade account for recording debits and credits to general accounting, cost accounting or budget accounting.		

ABIE/ BBIE/ ASBIE	Dictionary Entry Name	Definition	Occurrence Min	Occurrence Max
BBIE	Trade_ Accounting Account. Identification. Identifier	The unique identifier for this trade accounting account.	1	1
BBIE	Trade_ Accounting Account. Set Trigger. Code	A code specifying a set trigger for this trade accounting account to be used in response to a specific event or a set of events.	0	1
BBIE	Trade_ Accounting Account. Type. Code	The code specifying the type of trade accounting account, such as general (main), secondary, cost accounting or budget account.	0	1
BBIE	Trade_ Accounting Account. Amount Type. Code	The code specifying the amount type for this trade accounting account.	0	1
BBIE	Trade_ Accounting Account. Name. Text	The name, expressed as text, of this trade accounting account.	0	1
BBIE	Trade_ Accounting Account. Cost Reference Dimension Pattern. Text	The cost reference dimension pattern, expressed as text, for this trade accounting account.	0	1
ABIE	Trade_ Address. Details	The location at which a particular trade related organization or person may be found or reached.		
BBIE	Trade_ Address. Identification. Identifier	A unique identifier for this trade address.	0	1
BBIE	Trade_ Address. Postcode. Code	A code specifying the postcode of this trade address.	0	1
BBIE	Trade_ Address. Post Office Box. Text	The unique identifier, expressed as text, of a container commonly referred to as a box, in a post office or other postal service location, assigned to a person or organization, where postal items may be kept for this trade address.	0	1
BBIE	Trade_ Address. Building Name. Text	The name, expressed as text, of a building, a house or other structure on a street at this trade address.	0	1
BBIE	Trade_ Address. Line One. Text	The first free form line, expressed as text, of this trade address.	0	1
BBIE	Trade_ Address. Line Two. Text	The second free form line, expressed as text, of this trade address.	0	1
BBIE	Trade_ Address. Line Three. Text	The third free form line, expressed as text, of this trade address.	0	1
BBIE	Trade_ Address. Line Four. Text	The fourth free form line, expressed as text, of this trade address.	0	1

ABIE/ BBIE/ ASBIE	Dictionary Entry Name	Definition	Occurrence Min	Occurrence Max
BBIE	Trade_ Address. Line Five. Text	The fifth free form line, expressed as text, of this trade address.	0	1
BBIE	Trade_ Address. Street Name. Text	A name, expressed as text, of a street or thoroughfare for this trade address.	0	1
BBIE	Trade_ Address. City Name. Text	The name, expressed as text, of the city, town or village of this trade address.	0	1
BBIE	Trade_ Address. City Sub-Division Name. Text	A name, expressed as text, of a sub-division of a city for this trade address, for example a district or borough.	0	1
BBIE	Trade_ Address. Country. Identifier	The unique identifier of a country for this trade address.	0	1
BBIE	Trade_ Address. Country Name. Text	A name, expressed as text, of the country for this trade address.	0	unbounded
BBIE	Trade_ Address. Country Sub-Division. Identifier	A unique identifier of the country sub-division for this trade address.	0	1
BBIE	Trade_ Address. Country Sub-Division Name. Text	A name, expressed as text, of the sub-division of a country for this trade address.	0	unbounded
BBIE	Trade_ Address. Attention Of. Text	The name, expressed as text, of a person or department in the organization to whom incoming mail is marked with words such as 'for the attention of' or 'FAO' or 'ATTN' for this trade address.	0	1
BBIE	Trade_ Address. Care Of. Text	The name, expressed as text, of a person or organization at this trade address to whom incoming mail is marked with words such as 'care of' or 'C/O'.	0	1
BBIE	Trade_ Address. Building Number. Text	The building number, expressed as text, in this trade address.	0	1
BBIE	Trade_ Address. Department Name. Text	The name, expressed as text, of a department for this trade address.	0	1
BBIE	Trade_ Address. Additional_Street Name. Text	The additional name of a street, expressed as text, for this trade address.	0	1
ABIE	Trade_ Allowance Charge. Details	A component of pricing, such as an allowance or charge for trade purposes.		
BBIE	Trade_ Allowance Charge. Charge. Indicator	The indication of whether or not the trade allowance charge is a charge.	0	1

ABIE/ BBIE/ ASBIE	Dictionary Entry Name	Definition	Occurrence Min	Occurrence Max
BBIE	Trade_ Allowance Charge. Identification. Identifier	The unique identifier for this trade allowance charge.	0	1
BBIE	Trade_ Allowance Charge. Sequence. Numeric	The sequence number for applying this trade allowance charge.	0	1
BBIE	Trade_ Allowance Charge. Calculation. Percent	The percentage applied to calculate this trade allowance charge.	0	1
BBIE	Trade_ Allowance Charge. Basis. Amount	The monetary value that is the basis on which this trade allowance charge is calculated.	0	1
BBIE	Trade_ Allowance Charge. Basis. Quantity	The quantity on which this trade allowance charge is based.	0	1
BBIE	Trade_ Allowance Charge. Prepaid. Indicator	The indication of whether or not this trade allowance charge is prepaid.	0	1
BBIE	Trade_ Allowance Charge. Actual. Amount	An actual monetary value of the trade allowance charge.	0	unbounded
BBIE	Trade_ Allowance Charge. Unit_ Basis. Amount	The monetary value of the unit basis on which the allowance or charge is calculated.	0	1
BBIE	Trade_ Allowance Charge. Reason. Code	The code specifying the reason for this trade allowance charge.	0	1
BBIE	Trade_ Allowance Charge. Reason. Text	The reason, expressed as text, for this trade allowance charge.	0	1
BBIE	Trade_ Allowance Charge. Type. Code	The code specifying the type of this trade allowance charge.	0	1
ASBIE	Trade_ Allowance Charge. Category. Trade_ Tax	A tax category of this trade allowance charge.	0	unbounded
ASBIE	Trade_ Allowance Charge. Actual. Trade_ Currency Exchange	The actual trade currency exchange for this trade allowance charge.	0	1
ABIE	Trade_ Contact. Details	A person or a department that acts as a point of contact with another person or department in a trading relationship.		
BBIE	Trade_ Contact. Identification. Identifier	The unique identifier for this trade contact.	0	1
BBIE	Trade_ Contact. Person Name. Text	The name, expressed as text, of this trade contact person.	0	1
BBIE	Trade_ Contact. Department Name. Text	The name, expressed as text, of the department to which this trade contact belongs within an organization.	0	1
BBIE	Trade_ Contact. Type. Code	The code specifying the type of trade contact.	0	1

ABIE/ BBIE/ ASBIE	Dictionary Entry Name	Definition	Occurrence Min	Occurrence Max
BBIE	Trade_Contact. Job Title. Text	The job title, position or designation, expressed as text, of this trade contact within an organization, such as Director, Software Engineer, Purchasing Manager.	0	1
BBIE	Trade_Contact. Responsibility. Text	A responsibility, expressed as text, of this trade contact.	0	1
BBIE	Trade_Contact. Person_ Identification. Identifier	A unique identifier for this trade contact person.	0	unbounded
ASBIE	Trade_Contact. Telephone. Universal_ Communication	Telephone communication information for this trade contact.	0	1
ASBIE	Trade_Contact. Direct_ Telephone. Universal_ Communication	The direct telephone communication information for this trade contact.	0	1
ASBIE	Trade_Contact. Mobile_ Telephone. Universal_ Communication	The mobile telephone communication information for this trade contact.	0	1
ASBIE	Trade_Contact. Fax. Universal_ Communication	Fax communication information for this trade contact.	0	1
ASBIE	Trade_Contact. Email_ URI. Universal_ Communication	The email URI communication information for this trade contact.	0	1
ASBIE	Trade_Contact. Telex. Universal_ Communication	Telegraphy (Telex) communication information for this trade contact.	0	1
ASBIE	Trade_Contact. VOIP. Universal_ Communication	Voice Over Internet Protocol (VOIP) communication information for this trade contact.	0	1
ASBIE	Trade_Contact. Instant Messaging. Universal_ Communication	Instant messaging communication information for this trade contact.	0	1
ASBIE	Trade_Contact. Specified. Note	A note specified for this trade contact.	0	unbounded
ASBIE	Trade_Contact. Specified. Contact_ Person	The contact person specified for this trade contact.	0	1
ABIE	Trade_ Country Sub-Division. Details	A political or physical area or region within the political boundaries of a country used or referenced for trade purposes.		
BBIE	Trade_ Country Sub-Division. Identification. Identifier	The unique identifier for this trade country sub-division.	0	1
BBIE	Trade_ Country Sub-Division. Name. Text	A name, expressed as text, of this trade country sub-division.	0	unbounded

ABIE/ BBIE/ ASBIE	Dictionary Entry Name	Definition	Occurrence Min	Occurrence Max
ABIE	Trade_ Country. Details	The area of land that belongs to a nation together with its properties, such as population, political organization, etc., used or referenced for trade purposes.		
BBIE	Trade_ Country. Identification. Identifier	A unique identifier for this trade country.	0	1
BBIE	Trade_ Country. Name. Text	A name, expressed as text, of this trade country.	0	unbounded
ASBIE	Trade_ Country. Subordinate. Trade_ Country Sub-Division	A trade country sub-division that is subordinate to this trade country, such as a state, a county, a canton, a province.	0	unbounded
ABIE	Trade_ Currency Exchange. Details	The conversion of one currency to another for trade purposes.		
BBIE	Trade_ Currency Exchange. Source Currency. Code	The code specifying the source currency of a trade related currency conversion.	1	1
BBIE	Trade_ Currency Exchange. Source Unit Basis. Numeric	The numeric unit basis of the source currency used in this trade related currency exchange rate calculation.	0	1
BBIE	Trade_ Currency Exchange. Target Currency. Code	The code specifying the target currency of a trade related currency conversion.	1	1
BBIE	Trade_ Currency Exchange. Target Unit Base. Numeric	The numeric unit basis of the target currency used in this trade related currency exchange rate calculation.	0	1
BBIE	Trade_ Currency Exchange. Market. Identifier	The unique identifier of the currency exchange market from which the exchange rate is taken for trade purposes.	0	1
BBIE	Trade_ Currency Exchange. Conversion. Rate	The rate factor used for conversion from the source currency to the target currency for trade purposes.	1	1
BBIE	Trade_ Currency Exchange. Conversion Rate. Date Time	The date, time, date time or other date time value of the conversion rate for this trade related currency exchange.	0	1
ASBIE	Trade_ Currency Exchange. Associated. Referenced_ Document	An associated document referenced for this trade related currency exchange.	0	1
ABIE	Trade_ Delivery Terms. Details	Conditions agreed upon between the parties with regard to the delivery of goods and or services for trade purposes.		

ABIE/ BBIE/ ASBIE	Dictionary Entry Name	Definition	Occurrence Min	Occurrence Max
BBIE	Trade_ Delivery Terms. Delivery Type. Code	The code specifying the type of delivery for these trade delivery terms.	0	1
BBIE	Trade_ Delivery Terms. Description. Text	A textual description of these trade delivery terms.	0	unbounded
ASBIE	Trade_ Delivery Terms. Relevant. Trade_ Location	The trade location relevant for these trade delivery terms.	0	1
ABIE	Trade_ Location. Details	A physical location or place used or referenced for trade purposes.		
BBIE	Trade_ Location. Country. Identifier	The unique identifier of a country location used or referenced in trade.	0	1
BBIE	Trade_ Location. Country Name. Text	The name, expressed as text, of a country location used or referenced in trade.	0	1
BBIE	Trade_ Location. Identification. Identifier	The unique identifier for this location used or referenced in trade.	0	1
BBIE	Trade_ Location. Name. Text	The name, expressed as text, of this location used or referenced in trade.	0	1
ABIE	Trade_ Party. Details	An individual, a group, or a body having a role in a trade business function.		
BBIE	Trade_ Party. Identification. Identifier	A unique identifier of this trade party.	0	unbounded
BBIE	Trade_ Party. Global Identification. Identifier	A globally unique identifier of this trade party.	0	unbounded
BBIE	Trade_ Party. Name. Text	The name, expressed as text, for this trade party.	0	1
BBIE	Trade_ Party. Role. Code	A code specifying the role of this trade party.	0	unbounded
BBIE	Trade_ Party. Description. Text	A textual description of this trade party.	0	unbounded
ASBIE	Trade_ Party. Specified. Legal_ Organization	The legally constituted organization specified for this trade party.	0	1
ASBIE	Trade_ Party. Defined. Trade_ Contact	A trade contact defined for this trade party.	0	unbounded
ASBIE	Trade_ Party. Postal. Trade_ Address	The postal address for this trade party.	0	1
ASBIE	Trade_ Party. URI. Universal_ Communication	A Uniform Resource Identifier (URI) communication for this trade party, such as a web or email address.	0	unbounded
ASBIE	Trade_ Party. Specified. Tax_ Registration	A tax registration specified for this trade party.	0	unbounded
ASBIE	Trade_ Party. End Point_ URI. Universal_ Communication	The communication address of the end point URI for this trade party.	0	1

ABIE/ BBIE/ ASBIE	Dictionary Entry Name	Definition	Occurrence Min	Occurrence Max
ASBIE	Trade_ Party. Logo_ Associated. Specified_ Binary File	A file containing a specified binary representation of a logo associated with this trade party.	0	unbounded
ABIE	Trade_ Payment Discount Terms. Details	Trade terms and conditions by which a discount is or can be applied to a payable amount.		
BBIE	Trade_ Payment Discount Terms. Basis. Date Time	The date, time, date time, or other date time value used as the basis to calculate the discount in the trade payment discount terms.	0	1
BBIE	Trade_ Payment Discount Terms. Basis Period. Measure	The measure of the basis period for these trade payment discount terms.	0	1
BBIE	Trade_ Payment Discount Terms. Basis. Amount	A monetary value used as a basis to calculate the discount in these trade payment discount terms.	0	1
BBIE	Trade_ Payment Discount Terms. Calculation. Percent	The percent used to calculate the discount in these trade payment discount terms.	0	1
BBIE	Trade_ Payment Discount Terms. Actual Discount. Amount	A monetary value of the actual discount in these trade payment discount terms.	0	1
ABIE	Trade_ Payment Penalty Terms. Details	Trade terms and conditions by which a penalty is or can be applied to a payable amount.		
BBIE	Trade_ Payment Penalty Terms. Basis. Date Time	The date, time, date time, or other date time value used as the basis to calculate these trade payment penalty terms.	0	1
BBIE	Trade_ Payment Penalty Terms. Basis Period. Measure	The measure of the period used as a basis to calculate these trade payment penalty terms.	0	1
BBIE	Trade_ Payment Penalty Terms. Basis. Amount	A monetary value used as a basis to calculate these trade payment penalty terms.	0	1
BBIE	Trade_ Payment Penalty Terms. Calculation. Percent	The percent applied to calculate these trade payment penalty terms.	0	1
BBIE	Trade_ Payment Penalty Terms. Actual Penalty. Amount	A monetary value of the actual penalty in these trade payment penalty terms.	0	1
ABIE	Trade_ Payment Terms. Details	Terms and conditions by which payment has been or will be made for trade purposes.		
BBIE	Trade_ Payment Terms. Identification. Identifier	The unique identifier of these trade payment terms.	0	1

ABIE/ BBIE/ ASBIE	Dictionary Entry Name	Definition	Occurrence Min	Occurrence Max
BBIE	Trade_ Payment Terms. From Event. Code	The code specifying the event from which these trade payment terms are offered for a length of time.	0	1
BBIE	Trade_ Payment Terms. Settlement Period. Measure	The measure of the number of settlement periods from this trade payment term time reference to the latest payment date, such as 30 days, 3 months.	0	1
BBIE	Trade_ Payment Terms. Description. Text	A textual description of these trade payment terms.	0	unbounded
BBIE	Trade_ Payment Terms. Due Date. Date Time	The date, time, date time, or other date time value for a due date specified by these trade payment terms.	0	1
BBIE	Trade_ Payment Terms. Type. Code	A code specifying the type of trade payment terms.	0	1
BBIE	Trade_ Payment Terms. Instruction_ Type. Code	A code specifying a type of instruction for these trade payment terms.	0	1
BBIE	Trade_ Payment Terms. Direct Debit Mandate_ Identification. Identifier	An identifier of a direct debit mandate in these trade payment terms.	0	unbounded
BBIE	Trade_ Payment Terms. Partial Payment. Percent	A partial payment, expressed as a percent, in these trade payment terms.	0	1
BBIE	Trade_ Payment Terms. Payment Means_ Identification. Identifier	An identifier of a payment means in these trade payment terms.	0	unbounded
BBIE	Trade_ Payment Terms. Partial Payment. Amount	A monetary value of a partial payment in these trade payment terms.	0	unbounded
ASBIE	Trade_ Payment Terms. Applicable. Trade_ Payment Penalty Terms	Trade payment penalty terms applicable to these trade payment terms.	0	1
ASBIE	Trade_ Payment Terms. Applicable. Trade_ Payment Discount Terms	Trade payment discount terms applicable to these trade payment terms.	0	1
ASBIE	Trade_ Payment Terms. Payee. Trade_ Party	A payee party in these trade payment terms.	0	unbounded
ABIE	Trade_ Price. Details	A sum of money for which something is or may be bought or sold for trade purposes.		
BBIE	Trade_ Price. Type. Code	The code specifying the type of trade price.	0	1
BBIE	Trade_ Price. Charge. Amount	A monetary value of the trade price charge.	1	unbounded
BBIE	Trade_ Price. Basis. Quantity	The quantity on which the trade price is based.	0	1

ABIE/ BBIE/ ASBIE	Dictionary Entry Name	Definition	Occurrence Min	Occurrence Max
BBIE	Trade_ Price. Minimum. Quantity	The minimum quantity in a range for which this trade price applies.	0	1
BBIE	Trade_ Price. Maximum. Quantity	The maximum quantity in a range for which the trade price applies.	0	1
BBIE	Trade_ Price. Change Reason. Text	A reason, expressed as text, for a change of this trade price.	0	unbounded
BBIE	Trade_ Price. Order_ Unit Conversion Factor. Numeric	The value used as the factor to convert the order unit into the price unit for this trade price.	0	1
ASBIE	Trade_ Price. Applied. Trade_ Allowance Charge	An allowance or charge applied to the trade price.	0	unbounded
ASBIE	Trade_ Price. Validity. Specified_ Period	A specified period for which this trade price is valid.	0	1
ASBIE	Trade_ Price. Delivery. Trade_ Location	A delivery location for this trade price.	0	unbounded
ASBIE	Trade_ Price. Trade_ Comparison. Reference_ Price	A price that provides a trade comparison with this trade price.	0	unbounded
ASBIE	Trade_ Price. Associated. Referenced_ Document	An associated document referenced for this trade price.	0	unbounded
ABIE	Trade_ Product Instance. Details	An individual trade product or batch of similar trade products produced by human or mechanical effort or by a natural process.		
BBIE	Trade_ Product Instance. Global Serial_ Identification. Identifier	The unique global serial identifier for this trade product instance.	0	1
BBIE	Trade_ Product Instance. Batch_ Identification. Identifier	The unique batch identifier for this trade product instance.	0	1
BBIE	Trade_ Product Instance. Kanban_ Identification. Identifier	The unique kanban identifier for this trade product instance.	0	1
BBIE	Trade_ Product Instance. Supplier Assigned Serial_ Identification. Identifier	The unique supplier assigned serial identifier for this trade product instance.	0	1
BBIE	Trade_ Product Instance. Best Before. Date Time	The date, time, date time, or other date time value before which it is best to consume the items contained in this trade product instance.	0	1
BBIE	Trade_ Product Instance. Expiry. Date Time	The date, time, date time, or other date time value of expiry of the items contained in the trade product instance.	0	1

ABIE/ BBIE/ ASBIE	Dictionary Entry Name	Definition	Occurrence Min	Occurrence Max
BBIE	Trade_ Product Instance. Sell By. Date Time	The date, time, date time, or other date time value by after which the items contained in the trade product instance should not be sold.	0	1
BBIE	Trade_ Product Instance. Serial_ Identification. Identifier	A unique serial identifier for this trade product instance.	0	unbounded
BBIE	Trade_ Product Instance. Registration_ Identification. Identifier	A unique registration identifier, such as a vehicle licence plate identification, for this trade product instance.	0	unbounded
ASBIE	Trade_ Product Instance. Production. Supply Chain_ Event	The production event for this trade product instance.	0	1
ASBIE	Trade_ Product Instance. Packaging. Supply Chain_ Event	The packaging event for this trade product instance.	0	1
ASBIE	Trade_ Product Instance. Applicable. Material_ Goods Characteristic	A distinguishing material feature applicable to this trade product instance.	0	unbounded
ASBIE	Trade_ Product Instance. Applicable. Product_ Characteristic	A product characteristic applicable to this trade product instance.	0	unbounded
ABIE	Trade_ Product. Details	Any tangible output or service produced by human or mechanical effort or by a natural process for trade purposes.		
BBIE	Trade_ Product. Identification. Identifier	A unique identifier for this trade product.	0	1
BBIE	Trade_ Product. Global_ Identification. Identifier	A unique global identifier for this trade product.	0	1
BBIE	Trade_ Product. Seller Assigned_ Identification. Identifier	The unique seller assigned identifier for this trade product.	0	1
BBIE	Trade_ Product. Buyer Assigned_ Identification. Identifier	The unique buyer assigned identifier for this trade product.	0	1
BBIE	Trade_ Product. Manufacturer Assigned_ Identification. Identifier	A unique manufacturer assigned identifier for this trade product.	0	1
BBIE	Trade_ Product. Name. Text	A name, expressed as text, for this trade product.	0	unbounded
BBIE	Trade_ Product. Trade_ Name. Text	A trade name, expressed as text, for this trade product.	0	1
BBIE	Trade_ Product. Description. Text	A textual description for this trade product.	0	1
BBIE	Trade_ Product. Type. Code	A code specifying the type of trade product.	0	1
BBIE	Trade_ Product. Net Weight. Measure	A measure of the net weight (mass) of this trade product.	0	1
BBIE	Trade_ Product. Gross Weight. Measure	A measure of the gross weight (mass) of this trade	0	1

ABIE/ BBIE/ ASBIE	Dictionary Entry Name	Definition	Occurrence Min	Occurrence Max
		product.		
BBIE	Trade_ Product. Product Group. Identifier	A unique identifier for a product group for this trade product.	0	unbounded
BBIE	Trade_ Product. End Item_ Type. Code	A code specifying a type of end item for this trade product.	0	unbounded
BBIE	Trade_ Product. End Item_ Name. Text	An end item name, expressed as text, for this trade product.	0	unbounded
BBIE	Trade_ Product. Area Density. Measure	The measure of the area density, such as paper density 100 gsm, of this trade product.	0	1
BBIE	Trade_ Product. Use_ Description. Text	A textual description of a use of this trade product.	0	unbounded
BBIE	Trade_ Product. Brand_ Name. Text	The brand name, expressed as text, for this trade product.	0	1
BBIE	Trade_ Product. Sub-Brand_ Name. Text	The sub-brand name, expressed as text, for this trade product.	0	1
BBIE	Trade_ Product. Drained_ Net Weight. Measure	The measure of the drained net weight (mass) of this trade product.	0	1
BBIE	Trade_ Product. Variable Measure. Indicator	The indication of whether or not instances of this trade product have a variable measure, such as weight, length or volume.	0	1
BBIE	Trade_ Product. Colour. Code	The code specifying the colour for this trade product.	0	1
BBIE	Trade_ Product. Colour_ Description. Text	A textual description of the colour of this trade product.	0	unbounded
BBIE	Trade_ Product. Designation. Text	A designation, expressed as text, for this trade product.	0	unbounded
BBIE	Trade_ Product. Formatted Cancellation_ Announced Launch. Date Time	The formatted date, time, date time, or other date time value of the cancellation of the announced launch of this trade product.	0	1
BBIE	Trade_ Product. Formatted Latest_ Product Data Change. Date Time	The formatted date, time, date time, or other date time value of the latest change in the product data for this trade product.	0	1
ASBIE	Trade_ Product. Applicable. Product_ Characteristic	A characteristic applicable to this trade product.	0	unbounded
ASBIE	Trade_ Product. Applicable. Material_ Goods Characteristic	A material goods characteristic applicable to this trade product.	0	unbounded
ASBIE	Trade_ Product. Designated. Product_ Classification	A product classification designated for this trade product.	0	unbounded

ABIE/ BBIE/ ASBIE	Dictionary Entry Name	Definition	Occurrence Min	Occurrence Max
ASBIE	Trade_ Product. Individual. Trade_ Product Instance	An individual instance of this trade product.	0	unbounded
ASBIE	Trade_ Product. Certification Evidence_ Reference. Referenced_ Document	A referenced certification evidence document for this trade product.	0	unbounded
ASBIE	Trade_ Product. Inspection_ Reference. Referenced_ Document	A referenced inspection document for this trade product.	0	unbounded
ASBIE	Trade_ Product. Origin. Trade_ Country	A country of origin for this trade product.	0	1
ASBIE	Trade_ Product. Linear. Spatial_ Dimension	Linear spatial dimensions of this trade product.	0	1
ASBIE	Trade_ Product. Minimum_ Linear. Spatial_ Dimension	Minimum linear spatial dimensions of this trade product.	0	1
ASBIE	Trade_ Product. Maximum_ Linear. Spatial_ Dimension	Maximum linear spatial dimensions of this trade product.	0	1
ASBIE	Trade_ Product. Manufacturer. Trade_ Party	A manufacturer party for this trade product.	0	1
ASBIE	Trade_ Product. Presentation. Specified_ Binary File	A binary file presentation specified for this trade product.	0	unbounded
ASBIE	Trade_ Product. MSDS_ Reference. Referenced_ Document	A Material Safety Data Sheet (MSDS) document referenced for this product.	0	1
ASBIE	Trade_ Product. Additional_ Reference. Referenced_ Document	An additional referenced document for this trade product, such as a manual or a certificate.	0	unbounded
ASBIE	Trade_ Product. Legal Rights Owner. Trade_ Party	The party that owns the legal rights for this trade product.	0	1
ASBIE	Trade_ Product. Brand Owner. Trade_ Party	The party that owns the brand of this trade product.	0	1
ASBIE	Trade_ Product. Included. Referenced_ Product	An included product referenced from this trade product.	0	unbounded
ASBIE	Trade_ Product. Information. Note	An information note for this trade product.	0	unbounded
ABIE	Trade_ Tax. Details	A trade related fiscal levy or duty.		
BBIE	Trade_ Tax. Calculated. Amount	A monetary value resulting from the calculation of this trade related tax, levy or duty.	0	unbounded
BBIE	Trade_ Tax. Type. Code	The code specifying the type of trade related tax, levy or duty, such as a code for a Value Added Tax (VAT) [Reference United Nations Code List (UNCL) 5153].	0	1
BBIE	Trade_ Tax. Exemption Reason. Text	The reason, expressed as text, for exemption from this trade related tax, levy or duty.	0	1

ABIE/ BBIE/ ASBIE	Dictionary Entry Name	Definition	Occurrence Min	Occurrence Max
BBIE	Trade_Tax. Calculated. Rate	The rate used to calculate the amount of this trade related tax, levy or duty.	0	1
BBIE	Trade_Tax. Calculation Sequence. Numeric	A numeric expression of the sequence in which this trade related tax is to be or has been applied when multiple taxes are applicable per calculation, such as first "Value Added Tax (VAT)", second "Transfer".	0	1
BBIE	Trade_Tax. Basis. Quantity	The quantity used as the basis for calculating the amount of this trade related tax, levy or duty.	0	1
BBIE	Trade_Tax. Basis. Amount	A monetary value used as the basis on which this trade related tax, levy or duty is calculated.	0	unbounded
BBIE	Trade_Tax. Unit_Basis. Amount	A monetary value that constitutes the per unit basis on which this trade related tax, levy or duty is calculated.	0	unbounded
BBIE	Trade_Tax. Line Total_Basis. Amount	A monetary value used as the line total basis on which this trade related tax, levy or duty is calculated.	0	unbounded
BBIE	Trade_Tax. Allowance Charge_Basis. Amount	A monetary value used as the allowance and charge basis on which this trade related tax, levy or duty is calculated.	0	unbounded
BBIE	Trade_Tax. Category. Code	The code specifying the category to which this trade related tax, levy or duty applies, such as codes for "Exempt from Tax", "Standard Rate", "Free Export Item - Tax Not Charged" [Reference United Nations Code List (UNCL) 5305].	0	1
BBIE	Trade_Tax. Currency. Code	The code specifying the currency for this trade related tax, levy or duty [UNCL 6345].	0	1
BBIE	Trade_Tax. Jurisdiction. Text	A jurisdiction, expressed as text, to which this trade related tax, levy or duty applies.	0	unbounded
BBIE	Trade_Tax. Customs Duty. Indicator	The indication of whether or not this trade related tax, levy or duty is a customs duty.	0	1
BBIE	Trade_Tax. Exemption Reason. Code	A code specifying a reason for exemption from this trade related tax, levy or duty.	0	1

ABIE/ BBIE/ ASBIE	Dictionary Entry Name	Definition	Occurrence Min	Occurrence Max
BBIE	Trade_ Tax. Tax Basis Allowance. Rate	The rate of the tax basis allowance (deduction or discount) used to calculate the trade related tax, levy or duty.	0	1
BBIE	Trade_ Tax. Tax Point. Date	The date of the tax point when this trade related tax, levy or duty becomes applicable.	0	1
BBIE	Trade_ Tax. Type. Text	The type, expressed as text, of this trade related tax, levy or duty.	0	1
BBIE	Trade_ Tax. Information. Amount	A monetary value of an amount being reported for information for this trade related tax, levy or duty.	0	unbounded
BBIE	Trade_ Tax. Category Name. Text	A category name, expressed as text, of this trade related tax, levy or duty.	0	unbounded
BBIE	Trade_ Tax. Due Date Type. Code	The code specifying a type of due date for this trade tax.	0	1
BBIE	Trade_ Tax. Rate_ Applicable. Percent	The applicable rate, expressed as a percentage, for this trade tax, levy or duty.	0	1
ASBIE	Trade_ Tax. Specified. Trade_ Accounting Account	A specified accounting account for this trade related tax, levy or duty.	0	unbounded
ASBIE	Trade_ Tax. Service Supply. Trade_ Country	The country or country subdivision where a service was supplied for this trade tax.	0	1
ASBIE	Trade_ Tax. Buyer Repayable Tax_ Specified. Trade_ Accounting Account	The buyer repayable tax specified accounting account for this trade related tax, levy or duty.	0	1
ASBIE	Trade_ Tax. Seller Payable Tax_ Specified. Trade_ Accounting Account	The seller payable tax specified accounting account for this trade related tax, levy or duty.	0	1
ASBIE	Trade_ Tax. Seller Refundable Tax_ Specified. Trade_ Accounting Account	The seller refundable tax specified accounting account for this trade related tax, levy or duty.	0	1
ASBIE	Trade_ Tax. Buyer Deductible Tax_ Specified. Trade_ Accounting Account	The buyer deductible tax specified accounting account for this trade related tax, levy or duty.	0	1
ASBIE	Trade_ Tax. Buyer Non-Deductible Tax_ Specified. Trade_ Accounting Account	The buyer non-deductible tax specified accounting account for this trade related tax, levy or duty.	0	1
ASBIE	Trade_ Tax. Place_ Applicable. Trade_ Location	A location where this trade tax is applicable.	0	unbounded

ABIE/ BBIE/ ASBIE	Dictionary Entry Name	Definition	Occurrence Min	Occurrence Max
ABIE	Transport_ Cargo. Details	Information about goods being transported identifying their nature for customs, statistical or transport purposes.		
BBIE	Transport_ Cargo. Type. Code	The code, such as UNECE Recommendation 21 single digit codes, specifying the type of transported cargo.	0	1
BBIE	Transport_ Cargo. Identification. Text	The identification, expressed as text, of this transport cargo that is sufficient to identify it for customs, statistical or transport purposes.	0	1
BBIE	Transport_ Cargo. Operational Category. Code	The code specifying the operational category for this transport cargo, such as obnoxious or military.	0	1
BBIE	Transport_ Cargo. Statistical Classification. Code	The code specifying a statistical classification for this transport cargo.	0	1
ABIE	Universal_ Communication. Details	The exchange of thoughts, messages, or information, as universally exchanged by speech, signals, writing, or behaviour between persons and/or organizations.		
BBIE	Universal_ Communication. URI. Identifier	The Uniform Resource Identifier (URI), such as a web or an email address, for this universal communication.	0	1
BBIE	Universal_ Communication. Channel. Code	The code specifying the channel or manner in which a universal communication can be made, such as telephone or email.	0	1
BBIE	Universal_ Communication. Complete Number. Text	The text string of characters that make up the complete number for this universal communication.	0	1
ABIE	Valuation_ Breakdown Statement. Details	A detailed statement of work, prices, and dimensions for this valuation.		
BBIE	Valuation_ Breakdown Statement. Identification. Identifier	The unique identifier for this valuation breakdown statement.	1	1
BBIE	Valuation_ Breakdown Statement. Name. Text	The name, expressed as text, for this valuation breakdown statement.	1	1
BBIE	Valuation_ Breakdown Statement. Description. Text	A textual description of this valuation breakdown statement.	0	unbounded

ABIE/ BBIE/ ASBIE	Dictionary Entry Name	Definition	Occurrence Min	Occurrence Max
BBIE	Valuation_ Breakdown Statement. Measurement Method_ Identification. Identifier	A unique identifier of a method of measurement for this valuation breakdown statement.	0	unbounded
BBIE	Valuation_ Breakdown Statement. Creation. Date Time	The date, time, date time, or other date time value of the creation of this valuation breakdown statement.	1	1
BBIE	Valuation_ Breakdown Statement. Default_ Currency. Code	The code specifying the default currency for this valuation breakdown statement.	1	1
BBIE	Valuation_ Breakdown Statement. Default_ Language. Code	The code specifying the default language for this valuation breakdown statement.	1	1
BBIE	Valuation_ Breakdown Statement. Comment. Text	A comment, expressed as text, for this valuation breakdown statement.	0	unbounded
BBIE	Valuation_ Breakdown Statement. Type. Code	A code specifying the type of valuation breakdown statement.	0	unbounded
BBIE	Valuation_ Breakdown Statement. Requested Action. Code	A code specifying the requested action for this valuation breakdown statement.	0	unbounded
BBIE	Valuation_ Breakdown Statement. Price List_ Identification. Identifier	The identifier of a price list for this valuation breakdown statement.	0	1
BBIE	Valuation_ Breakdown Statement. Contractual Language. Code	The code specifying the contractual language for this valuation breakdown statement.	0	1
ASBIE	Valuation_ Breakdown Statement. Item. Grouped_ Work Item	A grouped work item in this valuation breakdown statement.	0	unbounded
ASBIE	Valuation_ Breakdown Statement. Item. Basic_ Work Item	A basic work item in this valuation breakdown statement.	0	unbounded
ASBIE	Valuation_ Breakdown Statement. Total. Calculated_ Price	A total calculated price for this valuation breakdown statement.	0	unbounded
ASBIE	Valuation_ Breakdown Statement. Changed. Recorded_ Status	A changed recorded status for this valuation breakdown statement.	0	unbounded
ASBIE	Valuation_ Breakdown Statement. Creation. Specified_ Binary File	A specified binary file used to create this valuation breakdown statement.	0	unbounded
ASBIE	Valuation_ Breakdown Statement. Reader. Specified_ Binary File	A specified binary file used to read this valuation breakdown statement.	0	unbounded
ASBIE	Valuation_ Breakdown Statement. Referenced. Specified_ Binary File	A specified binary file referenced by this valuation breakdown statement.	0	unbounded

ABIE/ BBIE/ ASBIE	Dictionary Entry Name	Definition	Occurrence Min	Occurrence Max
ABIE	Work Item_ Complex Description. Details	An aggregation of descriptive information consisting of different but related characteristics that together constitute a work item complex description.		
BBIE	Work Item_ Complex Description. Abstract. Text	A textual abstract of the content of the work item complex description.	0	unbounded
BBIE	Work Item_ Complex Description. Content. Text	Content, expressed as text, for this work item complex description.	0	unbounded
BBIE	Work Item_ Complex Description. Contractual Language. Code	The code specifying the contractual language for this work item complex description.	0	1
ASBIE	Work Item_ Complex Description. Requesting. Specification_ Query	A requesting specification query for this work item complex description.	0	unbounded
ASBIE	Work Item_ Complex Description. Responding. Specification_ Response	A responding specification response for this work item complex description.	0	unbounded
ASBIE	Work Item_ Complex Description. Subset. Work Item_ Complex Description	The complex description subset for this work item complex description.	0	1
ABIE	Work Item_ Dimension. Details	A measure of spatial extent associated with this work item, such as length, breadth, or height.		
BBIE	Work Item_ Dimension. Identification. Identifier	The unique identifier for this work item dimension.	0	1
BBIE	Work Item_ Dimension. Value. Measure	The measured value for this work item dimension.	1	1
BBIE	Work Item_ Dimension. Description. Text	The textual description of this work item dimension.	0	1
BBIE	Work Item_ Dimension. Type. Code	The code specifying the type of this work item dimension.	1	1
BBIE	Work Item_ Dimension. Contractual Language. Code	The code specifying the contractual language for this work item dimension.	0	1
ASBIE	Work Item_ Dimension. Component. Work Item_ Dimension	A work item component dimension for this work item dimension.	0	unbounded
ABIE	Work Item_ Quantity Analysis. Details	The quantity analysis for this work item.		
BBIE	Work Item_ Quantity Analysis. Identification. Identifier	The unique identifier for this work item quantity analysis.	1	1
BBIE	Work Item_ Quantity Analysis. Actual. Quantity	The actual quantity for this work item quantity analysis.	0	1
BBIE	Work Item_ Quantity Analysis. Description. Text	The textual description of this work item quantity analysis.	0	1

ABIE/ BBIE/ ASBIE	Dictionary Entry Name	Definition	Occurrence Min	Occurrence Max
BBIE	Work Item_ Quantity Analysis. Actual Quantity. Percent	The percentage of a total quantity that the actual quantity of this work item quantity analysis represents.	0	1
BBIE	Work Item_ Quantity Analysis. Status. Code	The code specifying the status of this work item quantity analysis, such as partial, approved, not approved.	0	1
BBIE	Work Item_ Quantity Analysis. Type. Code	The code specifying the type of work item quantity analysis.	0	1
BBIE	Work Item_ Quantity Analysis. Primary_ Classification. Code	A code specifying a primary classification value for this work item quantity analysis.	0	unbounded
BBIE	Work Item_ Quantity Analysis. Alternative_ Classification. Code	A code specifying an alternative classification value for this work item quantity analysis.	0	unbounded
BBIE	Work Item_ Quantity Analysis. Contractual Language. Code	The code specifying the contractual language for this work item quantity analysis.	0	1
ASBIE	Work Item_ Quantity Analysis. Actual Quantity. Work Item_ Dimension	A work item dimension of the actual quantity in this work item quantity analysis.	0	unbounded
ASBIE	Work Item_ Quantity Analysis. Breakdown. Work Item_ Quantity Analysis	A quantity analysis breakdown of this work item quantity analysis.	0	unbounded
ASBIE	Work Item_ Quantity Analysis. Changed. Recorded_ Status	A changed recorded status for this work item quantity analysis.	0	unbounded

END

2.7.3 Code Lists Used

2.7.3.1 New Code List

Not applicable

2.7.3.2 Additions to an Existing Code List

Not applicable

2.7.3.3 Use or Reference of an Existing Code List

Nr	Data Element	Agency Identifier	Code List Identifier	Code List Version
1	AccountingAccountType	EDIFICAS-EU	UN02000101	D11A
2	AccountingAmountType	EDIFICAS-EU	UN02000102	D11A
3	ActionCode	UNECE	UN02000124	D15B

Nr	Data Element	Agency Identifier	Code List Identifier	Code List Version
4	AllowanceChargeIdentificationCode	UNECE	UN02000134	D15B
5	AllowanceChargeReasonCode	UNECE	UN02000118	D15B
6	AutomaticDataCaptureMethodCode	UNECE	UN02000119	D15B
7	CargoOperationalCategoryCode	UNECE	UN02000077	D15B
8	CargoTypeCode	UNECE	UN02000096	1996 Rev2Final
9	CommodityIdentificationCode	UNECE	UN02000053	D15B
10	CommunicationMeansTypeCode	UNECE	UN02000121	D15B
11	ContactFunctionCode	UNECE	UN02000122	D15B
12	DeliveryTermsCode	UNECE	UN02000005	2010
13	DimensionTypeCode	UNECE	UN02000071	D15B
14	DocumentNameCode_ Accounting	UNECE	UN02000110	D15B
15	DocumentNameCode	UNECE	UN02000006	D15B
16	DocumentStatusCode	UNECE	UN02000025	D15B
17	DutyorTaxorFeeCategoryCode	UNECE	UN02000014	D15B
18	DutyTaxFeeTypeCode	UNECE	UN02000015	D15B
19	EquipmentSizeTypeDescriptionCode	UNECE	UN02000061	D15B
20	EventTimeReferenceCode	UNECE	UN02000183	D15B
21	EventTimeReferenceCodePaymentTermsEvent	UNECE	UN02000008	D15B
22	FreightChargeQuantityUnitBasisCode	UNECE	UN02000051	D15B
23	FreightChargeTariffCode	UNECE	UN02000074	D15B
24	ISO3AlphaCurrencyCode	ISO	UN02000004	2012-08-31
25	ISOTwo-letterCountryCode	ISO	UN02000003	Second Edition2006
26	MeasurementUnitCommonCodeLinear	UNECE	UN02000092	4
27	MessageFunctionCode	UNECE	UN02000125	D15B
28	PackagingMarkingCode	UNECE	UN02000126	D15B
29	PartyRoleCode	UNECE	UN02000044	D15B
30	PartyRoleCode Charge Paying	UNECE	UN02000062	D15B
31	PaymentGuaranteeMeansCode	UNECE	UN02000009	D15B
32	PaymentMeansChannelCode	UNECE	UN02000081	D15B
33	PaymentMeansCode	UNECE	UN02000010	D15B
34	PaymentTermsTypeCode	UNECE	UN02000083	D15B
35	PriceTypeCode	UNECE	UN02000013	D15B
36	ReferenceTypeCode	UNECE	UN02000048	D15B
37	TransportEquipmentCategoryCode	UNECE	UN02000087	D15B
38	TransportEquipmentFullnessCode	UNECE	UN02000088	D15B
39	TransportMeansTypeCode	UNECE	UN02000098	2007
40	TransportMovementStageCode	UNECE	UN02000091	D15B

Recommended code lists:

Data Element	Agency Identifier	Code List Identifier	Code List Version	Recommended for
FreightCostCode	UNECE	UN02000097	4	Logistics_ Service Charge. Identification. Identifier
GoodsTypeCode	UNECE	UN02000058	D15B	Consignment Item. Type. Code
GoodsTypeExtensionCode	UNECE	UN02000057	D15B	Consignment Item. Type Extension. Code
AdjustmentReasonDescriptionCode	UNECE	UN02000123	D15B	Delivery_ Adjustment. Reason. Code
MeasurementUnitCommonCodeVolume	UNECE	UN02000094	4	Consignment. Gross Volume. Measure
MeasurementUnitCommonCodeWeight	UNECE	UN02000095	4	Consignment Item. Gross Weight. Measure
PackageTypeCode	UNECE	UN02000043	2006	Packaging. Type. Code
PaymentMethodCode	UNECE	UN02000011	D15B	Payment Method. Code
PaymentTermsDescriptionIdentifier	UNECE	UN02000012	D15B	Trade_ Payment Terms. Identification. Identifier
TransportModeCode	UNECE	UN02000018	2	Transport Movement. Mode. Code

2.7.3.4 Restriction of an Existing Code List

AdjustmentReasonDescriptionCode		
- Restrictions to be applied in case of element: Delivery_ Adjustment. Reason. Code		
1	Agreed settlement	An adjustment made based on an agreement between partners.
5	Price query	An adjustment due to a price query.
7	Payment on account	Buyer is to make payment later.
8	Returnable container charge included	Adjustment made to deduct the returnable container charge.
9	Invoice error	Invoice not in accordance with the order.
10	Costs for draft	Cost of draft has been deducted from payment.
11	Bank charges	Bank charges have been deducted from payment.
12	Agent commission	Agent commission has been deducted from payment.
13	Counter claim	Buyer claims an existing (financial) obligation from seller which (partly) offsets the outstanding invoice(s).
19	Trade discount	Trade discount deducted from payment.
20	Deduction for late delivery	Penalty amount deducted for later delivery.
21	Advertising costs	Advertising costs deducted from payment.
22	Customs duties	Customs duties deducted from payment.
23	Telephone and postal costs	Telephone and postal costs deducted from payment.
24	Repair costs	Repair costs deducted from payment.
25	Attorney fees	Attorney fees deducted from payment.
26	Taxes	Taxes deducted from payment.
27	Reclaimed deduction	Buyer reclaims an unspecified deduction from the invoice(s) (to be) paid.
30	Direct payment to seller	Buyer states to have paid to seller.
34	Quoted as paid to you	Factor informs the seller that a certain invoice(s) was paid by

AdjustmentReasonDescriptionCode		
		the buyer directly to the seller.
36	Invoice not received	Buyer claims he did not receive the invoice for which payment is requested.
37	Credit note to debtor/not to us	Factor informs the seller that he did not receive copy of a credit note sent to the buyer.
38	Deducted bonus	Buyer has/will deduct a bonus he is entitled to from the payment.
39	Deducted discount	Buyer has/will deduct the discount he is entitled to from the payment.
40	Deducted freight costs	Buyer has/will deduct freight costs from the payment.
41	Deduction against other invoices	Deduction against invoices already settled.
42	Credit balance(s)	Buyer makes use of existing credit balance(s) to offset (partly) the outstanding invoice(s).
43	Reason unknown	Factor informs the seller that the reason of a commercial dispute raised by the buyer is unknown.
44	Awaiting message from seller	Buyer or factor are waiting for a (reply) message from the seller before a commercial dispute can be settled.
45	Debit note to seller	Buyer issued debit note to seller.
46	Discount beyond terms	Buyer has taken a discount larger than the discount terms agreed with the seller.
47	See buyer's letter	See correspondence from buyer.
48	Allowance/charge error	Error made by seller in the amount of allowance/charge.
50	Terms of sale error	Terms of sale not according to purchase order.
52	Wrong invoice	Invoice issued to wrong party.
53	Duplicate invoice	Invoice sent twice.
54	Weight error	Weight not in accordance with the order.
55	Additional charge not authorized	Additional charge not authorised.
56	Incorrect discount	Buyer states that calculated discount on the invoice(s) is wrongly calculated.
57	Price change	Price has been changed.
58	Variation	The adjustment is a variation from an agreed value.
59	Chargeback	Balance of one or more items charged back to seller.
60	Offset	Allocation of one or more debit items to one or more credit items or vice-versa.
61	Indirect payment	Payment in settlement of an invoice has been made to a party other than the designated creditor.
62	Financial reassignment	Previously assigned invoice/credit note is being reassigned.
63	Reinstatement of chargeback/offset	Reversal or cancellation of a chargeback and/or offset relating to an incorrect balance.
64	Expecting new terms	Buyer expects that seller revises the terms of payment of an invoice.
65	Settlement to agent	Invoice has been/to be paid to seller's agent.
66	Cash discount	An adjustment has been made due to the application of a cash discount.
67	Delcredere costs	Costs deducted from a total amount to pay for the services of central payment.
68	Early payment allowance adjustment	Adjustment results from the application of an early payment allowance.
69	Incorrect due date for monetary amount	Adjustment has been made because an incorrect due date was referred to with regard to the monetary amount.
70	Wrong monetary amount resulting from incorrect free goods quantity	Adjustment has been made because of a wrong monetary amount resulting from an incorrect free goods quantity.
73	Difference in tax rate	Adjustment due to a difference in tax rate.

AdjustmentReasonDescriptionCode		
74	Quantity discount	Adjustment due to a quantity discount.
75	Promotion discount	Adjustment due to a promotion discount.
77	Pricing discount	An adjustment has been made due to the application of a pricing discount.
78	Volume discount	Discount for reaching or exceeding an agreed accumulated volume.
79	Sundry discount	Adjustment has been made due to the application of a sundry discount.
80	Card holder signature missing	The adjustment was made due to the card holder not signing the filing document.
81	Card expiry date missing	The adjustment was made due to the card acceptor not specifying the expiry date within the filing document.
82	Card number error	The adjustment was made due to the card acceptor specifying an erroneous card number within the filing document.
83	Card expired	The adjustment was made due to the card acceptor specifying an expired expiry date within the filing document or electronic data.
84	Test card transaction	The adjustment was made due to a test card transaction, used for installing, maintaining or debugging purposes.
85	Permission limit exceeded	The adjustment was made due to the permission limit defined by card issuer or card company was exceeded without prior authorisation. Synonym: Floor limit.
86	Wrong authorisation code	The adjustment was made due to the authorisation code provided did not fit to the specified transaction.
87	Wrong authorised amount	The adjustment was made due to the specified amount not meeting the authorised amount for the transaction.
88	Authorisation failed	The adjustment was made due to the authorisation needed had failed.
89	Card acceptor data error	The adjustment was made due to the data regarding the card acceptor is erroneous.
90	Treasury management service charge	Charge for the service of treasury management.
91	Agreed discount	The reason for the adjustment is that a mutually agreed discount has been applied.
92	Expediting fee	The reason for the adjustment is that a fee for expediting has been applied.
93	Invoicing fee	The reason for the adjustment is that a fee for invoicing has been applied.
94	Freight charge	The reason for the adjustment is that freight charges has been applied.
95	Small order processing service charge	The reason for the adjustment is that a fee for processing of a small order (an order below a defined threshold) has been applied.
96	Currency exchange differences	An adjustment made due to a change in a currency exchange rate.
97	Insolvency	An adjustment made due to the partner's inability to pay open debts.
ZZZ	Mutually defined	A code assigned within a code list to be used on an interim basis and as defined among trading partners until a precise code can be assigned to the code list.

DocumentNameCode		
- Restrictions to be applied in case of element: Exchanged_ Document. Type. Code		
80	Debit note related to goods or services	Debit information related to a transaction for goods or services to the relevant party.
81	Credit note related to goods	Document message used to provide credit information related to a

DocumentNameCode		
	or services	transaction for goods or services to the relevant party.
82	Metered services invoice	Document/message claiming payment for the supply of metered services (e.g., gas, electricity, etc.) supplied to a fixed meter whose consumption is measured over a period of time.
83	Credit note related to financial adjustments	Document message for providing credit information related to financial adjustments to the relevant party, e.g., bonuses.
84	Debit note related to financial adjustments	Document/message for providing debit information related to financial adjustments to the relevant party.
261	Self billed credit note	A document which indicates that the customer is claiming credit in a self billing environment.
262	Consolidated credit note - goods and services	Credit note for goods and services that covers multiple transactions involving more than one invoice.
325	Proforma invoice	Document/message serving as a preliminary invoice, containing - on the whole - the same information as the final invoice, but not actually claiming payment.
380	Commercial invoice	(1334) Document/message claiming payment for goods or services supplied under conditions agreed between seller and buyer.
381	Credit note	(1113) Document/message for providing credit information to the relevant party.
383	Debit note	Document/message for providing debit information to the relevant party.
384	Corrected invoice	Commercial invoice that includes revised information differing from an earlier submission of the same invoice.
385	Consolidated invoice	Commercial invoice that covers multiple transactions involving more than one vendor.
386	Prepayment invoice	An invoice to pay amounts for goods and services in advance; these amounts will be subtracted from the final invoice.
389	Self-billed invoice	An invoice the invoicee is producing instead of the seller.
395	Consignment invoice	Commercial invoice that covers a transaction other than one involving a sale.
396	Factored credit note	Credit note related to assigned invoice(s).
	- Restricted in case of element: Trade_ Accounting Account. Set Trigger. Code	
105	Purchase order	Document/message issued within an enterprise to initiate the purchase of articles, materials or services required for the production or manufacture of goods to be offered for sale or otherwise supplied to customers.
220	Order	Document/message by means of which a buyer initiates a transaction with a seller involving the supply of goods or services as specified, according to conditions set out in an offer, or otherwise known to the buyer.
223	Lease order	Document/message for goods in leasing contracts.
224	Rush order	Document/message for urgent ordering.
245	Delivery release	Document/message issued by a buyer releasing the despatch of goods after receipt of the Ready for despatch advice from the seller.
315	Contract	(1296) Document/message evidencing an agreement between the seller and the buyer for the supply of goods or services; its effects are equivalent to those of an order followed by an acknowledgement of order.
320	Acknowledgement of order	Document/message acknowledging an undertaking to fulfil an order and confirming conditions or acceptance of conditions.
325	Proforma invoice	Document/message serving as a preliminary invoice, containing - on the whole - the same information as the final invoice, but not actually claiming payment.
326	Partial invoice	Document/message specifying details of an incomplete invoice.
380	Commercial invoice	(1334) Document/message claiming payment for goods or services supplied under conditions agreed between seller and buyer.

DocumentNameCode		
389	Self-billed invoice	An invoice the invoicee is producing instead of the seller.
393	Factored invoice	Invoice assigned to a third party for collection.
394	Lease invoice	Usage of INVOIC-message for goods in leasing contracts.
395	Consignment invoice	Commercial invoice that covers a transaction other than one involving a sale.
398	Cross docking despatch advice	Document by means of which the supplier or consignor informs the buyer, consignee or the distribution centre about the despatch of goods for cross docking.
399	Transshipment despatch advice	Document by means of which the supplier or consignor informs the buyer, consignee or the distribution centre about the despatch of goods for transshipment.
455	Extended credit advice	Document/message sent by an account servicing institution to one of its account owners, to inform the account owner of an entry that has been or will be credited to its account for a specified amount on the date indicated. It provides extended commercial information concerning the relevant remittance advice.
481	Remittance advice	Document/message advising of the remittance of payment.
533	Original accounting voucher	To indicate that the document/message justifying an accounting entry is original.
534	Copy accounting voucher	To indicate that the document/message justifying an accounting entry is a copy.
640	Delivery order	Document/message issued by a party entitled to authorize the release of goods specified therein to a named consignee, to be retained by the custodian of the goods.

MeasurementUnitCommonCode		
- Restrictions to be applied in case of element: Specified_ Binary File. Size. Measure		
4L	megabyte	A unit of information equal to 10 to the power of 6 (1000000) bytes.
E34	gigabyte	A unit of information equal to 10 to the power of 9 bytes.
E35	terabyte	A unit of information equal to 10 to the power of 12 bytes.

PartyRoleCode		
- Restrictions to be applied in case of element: Logistics_ Service Charge. Paying Party Role. Code		
AB	Buyer's agent/representative	Third party who arranged the purchase of merchandise on behalf of the actual buyer.
AE	Declarant's agent/representative	Any natural or legal person who makes a declaration to an official body on behalf of another natural or legal person, where legally permitted (CCC).
AF	Transit principal	Natural or legal person responsible for the satisfactory performance of a Customs transit operation. Source: CCC.
AH	Transit principal's agent/representative	Agent acting on behalf of the transit principal (CCC).
AQ	Approved consignor	Person or company approved by the relevant authority in the country to pack and export specific goods under Customs supervision.
AR	Authorized exporter	Exporter authorized/approved by Customs for special Customs procedures e.g. simplified procedure.
AT	Authorized importer	Importer authorized/approved by Customs for special Customs procedures e.g. simplified procedure.
AU	Authorized trader (transit)	Trader authorized/approved by Customs for special transit procedures e.g. simplified procedure.
CA	Carrier	[3126] Party undertaking or arranging transport of goods between named points.

PartyRoleCode		
CG	Carrier's agent	[3052] Party authorized to act for or on behalf of carrier.
CN	Consignee	[3132] Party to which goods are consigned.
CPD	Charges payer at destination	Party, other than the ordering party, which has to pay the charges concerning the destination operations.
CX	Consignee's agent	Party authorized to act on behalf of the consignee.
CZ	Consignor	[3336] Party which, by contract with a carrier, consigns or sends goods with the carrier, or has them conveyed by him. Synonym: shipper, sender.
EX	Exporter	[3030] Party who makes, or on whose behalf the export declaration is made, and who is the owner of the goods or has similar rights of disposal over them at the time when the declaration is accepted.
FW	Freight forwarder	[3170] Party arranging forwarding of goods.
GS	Consignor's representative	Party authorised to represent the consignor.
IM	Importer	[3020] Party who makes - or on whose behalf a Customs clearing agent or other authorized person makes - an import declaration. This may include a person who has possession of the goods or to whom the goods are consigned.
IV	Invoicee	[3006] Party to whom an invoice is issued.
PE	Payee	Identifies the credit party when other than the beneficiary.

2.8 Message Library Update

2.8.1 Message Assembly Submission

Not applicable

2.9 Core Component Library Update

2.9.1 Referenced CCL

Not applicable

2.9.2 CCL Update Submission

Not applicable

2.10 Model Exchange File

Not applicable

2.11 Additional Information

Not applicable

2.12 Definition of Terms

Term	Definition
Acceptance Of Goods	<ol style="list-style-type: none"> 1. Date on which the goods are taken over by the carrier at the place of acceptance (CMR 4). 2. The process of receiving a consignment usually against the issue of a receipt. As and from this moment the party accepting the consignment becomes responsible for the consignment.

Term	Definition
Accepted	To take on a responsibility or liability for something.
Account	A formal contractual relationship established to provide for regular banking, brokerage or business services.
Accounting	Record or statement of financial transactions.
Agent	A person or company that provides a particular service, typically one organizing transactions between two other parties.
Allowance	The amount of something allowed.
Allowance Charge	Details about a component of pricing, such as a service, promotion, allowance or charge.
Amount	A number of monetary units specified in a currency where the unit of currency is explicit or implied.
Available	1. Able to be used or obtained. 2. Goods positioning date/time, expected - Date/time on which goods are expected to be positioned.
Batch	n. A quantity or consignment of goods produced at one time. v. Arrange (things) in sets or groups.
Batch (No.)	(Identification of) a quantity or consignment of goods produced at one time.
Buyer	The party to which goods or services are sold.
Carrier	The party undertaking the transportation of goods from one point to another.
Cash	Money in the form of bills and coins.
Catalogue	A list of items arranged in a systematic order.
Category	A class or division of people or things having particular shared characteristics.
Characteristic	A feature or quality typical of a person, place, or thing.
Charge	An amount asked as a price for a service rendered or goods supplied (OED derived).
Classification	Arrangement (of a group) in classes or categories according to shared qualities or characteristics.
Commission	A sum paid to an agent in a commercial transaction.
Communication	The means of sending or receiving information, such as telephone lines or computers.
Communication (Address)	The unique identification of location, person or company within a specific means of sending or receiving information, such as telephone lines or computers.
Condition	The state of something or someone, with regard to appearance, fitness, or working order.
Conditions	Circumstances affecting the functioning or existence of something. A state of affairs that must exist before something else is possible.
Consignee	The party by whom the goods, cargo or containers are meant to be received. The actual physical receipt can take place by another party.
Consignment	A separately identifiable collection of goods items (available to be) transported from one consignor to one consignee via one or more modes of transport as specified in one single transport document.
Consignor	The party by whom goods, cargo and containers are sent. The physical dispatch can be done by another party.
Context	The circumstances that form the setting for an event, statement, or idea, and in terms of which it can be fully understood.
Contract	A legally binding agreement between two parties in which the specific titles, rights, commitments and obligations of both parties are defined.
Count	The total determined by counting.

Term	Definition
Country Of Arrival	The country to which a means of transport is scheduled to arrive or has arrived.
Country Of Departure	The country from which a means of transport is scheduled to depart or has departed.
Country Of Destination	The country to which goods are (to be) transported.
Country Of Origin	The country in which the goods have been produced or manufactured, according to criteria laid down for the purposes of application of the Customs tariff, of quantities restrictions, or of any other measure related to trade.
Country Sub-division	A formally recognized subdivision of a country.
Creditor	One who gives credit for money or goods; one to whom a debt is owing; correlative to debtor.
Currency	That which is current as a medium of exchange; the circulating medium (whether coins or notes); the money of a country in actual use.
Currency Exchange	The conversion of financial amounts in one currency to another.
Customer	The party to which or to whom goods and/or services are supplied.
Customs	The government organization that deals with the levying of duties and taxes on imported goods from foreign countries and the control over the export and import of goods.
Date	Identification of a particular calendar day, expressed by some combination of the data elements calendar year, calendar month, calendar week, calendar day, of day of the year.
Deductible	An amount or percentage that can be taken away from or applied to another amount for purpose of reduction.
Deduction	An amount that is or may be deducted.
Deliver	Bring and handover (a letter, goods or service) to the appropriate recipient.
Delivered	The quantity provided (of something promised or expected).
Delivery	1. The action of delivering something, especially letters, goods or services. 2. The physical process of handing over goods to the consignee or to the party acting on his behalf.
Delivery Date	The date on which the delivery of goods to takes place, is scheduled to take place, or must be received.
Delivery Terms	Conditions in a sales or transportation contract that specify the carrier, routing, freight charges, place of delivery, time of delivery, etc.
Dimension	A measurable extent, such as length, breadth or height.
Disbursement	The action of dispersing money that is paid out.
Discharge	The process of unloading the goods from a means of transport.
Discount	1. A deduction from the usual cost of something. 2. (Finance) a percentage deducted from the face value of a bill of exchange or promissory note when it changes hands before the due date.
Due	Required as a legal or moral obligation.
	Expected at, planned for, or required by a certain time.
Duration	The time during which something continues.
Duty	A payment levied on the import, export, manufacture, or sale of goods or services.
Earliest	Not before the time or date specified.
Effective Period	The time during which something runs its course, duration; allotted time; natural lifespan.
Electronic Communication	Communications in the general sense of any communication that involves having components such as microchips and transistors that control and direct electric currents. Used to encompass, fax, telephone, e-mail, EDI, etc.

Term	Definition
End	To come or bring to an end; finish..
Term	Definition
Event	A significant occurrence or happening related to an object process, or person.
Exclusive	Not divided or shared with others.
Expected	Regarded as likely to happen..
Expiry	The end or term of a period of time.
Family Name	A surname, the hereditary name common to all members of a family, as distinct from a forename.
Fee	A payment made to a professional person or to a professional or public body in exchange for advice or services.
Fiscal	Of or relating to government revenue, especially taxes.
Freight	Goods in transport from one location to another.
Freight Costs	Costs incurred when moving goods, by whatever means, from one place to another under the terms of a contract of carriage. In addition to transport costs, this may include such elements as packing, documentation, loading , unloading, and insurance (to the 2. The amount of money due for the carriage of goods and payable either in advance or upon delivery.
Frequency	1) The rate at which something occurs over a period or in a given sample. 2) Occurrence many times at short intervals.
Given Name	Another term for first name, a personal name given to someone at birth or baptism and used before (or after in some national styles) a family name.
Gross	Without deduction of tax or other contributions.
	Including contents or other variable items; overall.
Gross Price	Price inclusive of all discounts, rebates, etc.; sometimes called the retail price.
IBAN	Abbreviation of International Bank Account Number.
Identification	The action or process of identifying or the fact of being identified.
Identifier	Something which identifies.
Invoice	
Invoicee	One who receives the invoice and is expected to arrange its settlement.
Invoicer	One who issues the invoice.
Issued	1) Supplied or distributed for use. 2) Formally sent out or made known.
Level (Packaging)	The position in a series of packaging that groups items together within a package within a package etc.
Line Item	An article or unit of any kind included in an enumeration, computation, or sum total.
Location	A particular place or position.
Logistic Service Provider	Party providing logistic services such as warehousing, re-packing products, distribution and assembly.
Lot (No.)	(Identification of) a particular group or set of people or things.
Maximum	The highest value or extreme limit.
Means (Of Payment Guarantee)	This indicates the kind of guarantee covering the payment.
Means (Of Payment)	The method used for payment.
Means (Of Settlement)	An act that discharges obligations in respect of funds or securities transfers between two or more parties.

Term	Definition
Means (Of Transport)	The particular vehicle used for the transport of goods or persons.
Measure	A standard unit used to express size, amount, or degree.
Measurement	An amount, size, or extent as established by measuring.
Minimum	The smallest amount or quantity that is possible, usual, attainable, allowable, etc.
Monetary Adjustment	See Allowance Charge
Net	(Of an amount, value or price) remaining after deduction of tax or other contributions.
Net Price	Price after all discounts, rebates, etc., have been allowed; sometimes called the wholesale price.
Net Volume	1. The amount or quantity of something free from, or not subject to, any (further) deduction. 2. (Of a weight) excluding that of packaging.
Net Weight	Measurement of quantity by means of weighing, free from, or not subject to, any (further) deduction.
Non Repudiation	Non repudiation means that the originator must digitally sign the business data and the recipient must store the business data in its original form for the mutually agreed duration.
Number	An arithmetic value, expressed by a word, symbol or figure, representing a particular amount.
Original	1. The earliest form of something. 2. Existing from the beginning: first or earliest.
Package	1. The final product of the packing operation. 2. Consisting of the packing and the contents, e.g. a box, carton, crate, barrel, pallet, etc.
Packaging	The action or process of making something into a package or enclosing a thing in packaging; the action of wrapping something up.
Payee	A person or company to whom money is being paid or is due, especially in a transaction such as the payment of a cheque or money order.
Payment	The action of paying or the process of being paid.
Payment Terms	Conditions or stipulations limiting the paying of money or its equivalent for (also of) goods, services, etc.
Payor	The person or company named as responsible for the payment of a cheque, money order, or other financial 'paper' when it is redeemed.
Percentage	1) A rate, number, or amount in each hundred. 2) Any proportion or share in relation to a whole.
Period (Of Time)	A length or portion of time.
	A portion of time between two time points.
Prepaid	Paid for in advance.
Pre-Payment	Payment that has taken place before the delivery.
Previous	Existing or occurring before in time or order.
Price	The amount of money (or a material equivalent) expected, required, or given in payment for a commodity or service.
Product	Any tangible output or service produced by human or mechanical effort or by a natural process.
Product Instance	An instance of an individual product or batch of similar products produced by human or mechanical effort or by a natural process.
Quantity	A certain amount or number.
Term	Definition

Term	Definition
Rate	Numeric information that is assigned or is determined by calculation, counting, or sequencing. It does not require a unit of quantity or unit of measure.
Rate Basis	The basis of calculation of an amount of a charge or payment expressed as an amount per some feature.
Received	Taken delivery of.
Regime	A systematic or ordered way of doing something.
Regulation	A rule prescribed for the management of some matter, or for the regulating of conduct; a governing precept or direction; a standing rule.
Remittance	A sum of money remitted.
Seller	The party selling goods or services.
Sequence	The fact of following after or succeeding; the following of one thing after another in succession; an instance of this.
Serial Number	An identification number showing the position of a manufactured item in a series.
Service	Work or doing of work for another or for a community such as utilities and transport.
Service Charge	A charge made for banking or other services such as Freight Services.
Settlement	'settle' - pay (a debt or account)
Status	The position of affairs at a particular time.
Subdivision	Subdivisions of a country such as primary subdivisions, County (UK), Department (France), State (US) etc., secondary subdivisions such.
Supplier	Someone who makes (something needed) available to someone.
Tariff	A classified list or scale of charges made in any private or public business; as, a hotel tariff, a railroad tariff.
	A tax or duty to be paid on a particular class of imports or exports.
Tax	A levy or payment for the support of a government required of persons, groups, or businesses within the domain of that government.
Terms Of Delivery	All the conditions agreed upon between a seller and a buyer with regard to the delivery of goods and/or services, e.g. CIF, FOB, or EXW from the INCOTERMS Terms of Delivery.
Terms Of Freight	All the conditions (to be) agreed upon between a transport service provider and a transport service buyer about the type of freight and charges due to carriage and whether they are prepaid or are to be collected.
Terms Of Transport	All the conditions agreed upon between a transport service provider and a transport service buyer with regard to the transportation of goods, e.g. CIF, FOB, or EXW from the INCOTERMS Terms of Delivery.
Type	A category of people or things having common characteristics.
Ultimate Consignee	A final party to whom goods are consigned.
Value	1. Material or monetary worth. 2. The numerical amount denoted by an algebraic term; a magnitude, quantity, or number.