



Economic and Social Council

Distr.: General
10 April 2018

Original: English

Economic Commission for Europe

Inland Transport Committee

World Forum for Harmonization of Vehicle Regulations

175th session

Geneva, 19-22 June 2018

Item 4.8.5 of the provisional agenda

1958 Agreement:

Consideration of draft amendments

to existing UN Regulations submitted by GRRF

Proposal for Supplement 16 to UN Regulation No. 106 (Tyre for agricultural vehicles)

Submitted by the Working Party on Brakes and Running Gear*

The text reproduced below was adopted by the Working Party on Brakes and Running Gear (GRRF) at its eighty-sixth session (ECE/TRANS/WP.29/GRRF/86, para. 32). It is based on ECE/TRANS/WP.29/GRRF/86/Add.2. It is submitted to the World Forum for Harmonization of Vehicle Regulations (WP.29) and to the Administrative Committee AC.1 for consideration at their June 2018 sessions.

* In accordance with the programme of work of the Inland Transport Committee for 2018–2019 (ECE/TRANS/274, para. 123 and ECE/TRANS/2018/21/Add.1, Cluster 3.1), the World Forum will develop, harmonize and update Regulations in order to enhance the performance of vehicles. The present document is submitted in conformity with that mandate.

Supplement 16 to UN Regulation No. 106 (Tyre for agricultural vehicles)

Uniform provisions concerning the approval of pneumatic tyres for agricultural vehicles and their trailers

Page

Contents

Regulation

1.	Scope	3
2.	Definitions.....	3
3.	Markings	9
4.	Application for approval	10
5.	Approval.....	11
6.	Requirements.....	12
7.	Modification of tyre type and extension of approval	14
8.	Conformity of production.....	15
9.	Penalties for non-conformity of production	15
10.	Production definitively discontinued.....	15
11.	Names and addresses of Technical Services responsible for conducting approval tests, of test laboratories, and of Type Approval Authorities	16

Annexes

1	Communication	18
2	Arrangement of approval mark	20
3	Arrangement of tyre markings	21
4	List of load capacity indices (LI) and corresponding maximum mass to be carried (kg).....	28
5	Theoretical rim, outer diameter and nominal section width of tyres of certain size designations	29
6	Test method for measuring tyre dimensions	51
7	Variation of load capacity with speed	52
8	Test procedure to assess tyre resistance to bursting	55
9	Load/speed test procedure	56
10	Tyre classification code.....	59
11	Example of the pictogram to be marked on both tyre sidewalls of the tyres to explicit the maximum inflation pressure not to be exceeded for bead seating during tyre mounting	60

1. Scope

This Regulation covers new pneumatic tyres* designed primarily, but not only, for agricultural and forestry vehicles (power-driven vehicles in category T¹), agricultural machines (power-driven and trailed) and agricultural trailers, and identified by speed category symbols corresponding to speeds of 65 km/h (speed symbol "D") and below.

It does not apply to tyre types designated primarily for other purposes, such as:

- (a) Earth-moving equipment;
- (b) Industrial and lift trucks.

2. Definitions

For the purposes of this Regulation:

2.1. "*Type of agricultural tyre*" means tyres which do not differ in such essential characteristics as:

- (a) The manufacturer's name;
- (b) Tyre-size designation;
- (c) Category of use:
 - (i) Tractor - steering wheel**;
 - (ii) Tractor - drive wheel - standard tread;
 - (iii) Tractor - drive wheel - special tread;
 - (iv) Implement - traction;
 - (v) Implement - trailer;
 - (vi) Implement - mixed applications;
 - (vii) Forestry machines – standard tread;
 - (viii) Forestry machines – special tread;
 - (ix) Construction applications (IND).
- (d) Structure (diagonal or (bias-ply), bias-belted, radial-ply);
- (e) Speed category symbol;
- (f) Load capacity index;
- (g) Tyre cross-section.

¹ As defined in the Consolidated Resolution on the Construction of Vehicles (R.E.3.), document ECE/TRANS/WP.29/78/Rev.6, para. 2. - www.unece.org/trans/main/wp29/wp29wgs/wp29gen/wp29resolutions.html

* For the purpose of this Regulation "tyres" means "pneumatic tyres"

** See para. 2.24.

- 2.2. "*Manufacturer*" means the person or body who is responsible to the Type Approval Authority (TAA) for all aspects of the type-approval and for ensuring the conformity of production.
- 2.3. "*Brand name/trademark*" means the identification of the brand or trademark as defined by the tyre manufacturer and marked on the sidewall(s) of the tyre. The brand name/trademark may be the same as that of the manufacturer.
- 2.4. "*Trade description/commercial name*" means an identification of a range of tyres as given by the tyre manufacturer. It may coincide with the brand name/trademark.
- 2.5. For reference on the following terms see explanatory figure in Appendix 1.
- 2.6. "*Structure of a tyre*" means the technical characteristics of the tyre carcass. The following structures are distinguished in particular:
- 2.6.1. "*Diagonal*" or "*bias-ply*" describes a tyre structure in which the ply cords extend to the bead and are laid at alternate angles of substantially less than 90° to the centreline of the tread;
- 2.6.2. "*Bias-belted*" describes a tyre structure of diagonal (bias-ply) type in which the carcass is restricted by a belt comprising two or more layers of substantially inextensible cord material laid at alternate angles close to those of the carcass;
- 2.6.3. "*Radial*" describes a tyre structure in which the ply cords extend to the beads and are laid substantially at 90° to the centreline of the tread, the carcass being stabilised by an essentially inextensible circumferential belt;
- 2.7. "*Bead*" means the part of a tyre which is of such shape and structure as to fit the rim and hold the tyre on it;
- 2.8. "*Cord*" means the strands forming the fabric of the plies in the tyre;
- 2.9. "*Ply*" means a layer of rubber-coated parallel cords;
- 2.10. "*Carcass*" means that part of a tyre other than the tread and the rubber sidewalls which, when inflated, bears the load;
- 2.11. "*Tread*" means that part of a tyre which comes into contact with the ground;
- 2.12. "*Sidewall*" means the part of the tyre, excluding the tread, which is visible when the tyre, fitted to a rim, is viewed from the side;
- 2.13. "*Section width (S)*" means the linear distance between the outsides of the sidewalls of an inflated tyre, excluding elevations due to labelling (marking), decoration or protective bands or ribs;
- 2.14. "*Overall width*" means the linear distance between the outside of the sidewalls of an inflated tyre, including labelling (marking), decoration and protective bands or ribs;
- 2.15. "*Section height (h)*" means a distance equal to half the difference between the outer diameter of the tyre and the nominal rim diameter;
- 2.16. "*Nominal aspect ratio (Ra)*" means one hundred times the number obtained by dividing the number expressing the nominal section height in millimetres by the number expressing the nominal section width in millimetres;
- 2.17. "*Outer diameter (D)*" means the overall diameter of an inflated new tyre;
- 2.18. "*Tyre-size designation*" means a designation showing:

-
- 2.18.1. The nominal section width (S1). This value must be expressed in mm.
 - 2.18.2. The nominal aspect ratio (Ra).
 - 2.18.3. An indication of the structure, placed in front of the nominal rim diameter marking, as follows:
 - 2.18.3.1. On diagonal (bias-ply) tyres, the symbol "-" or the letter "D";
 - 2.18.3.2. On radial-ply tyres, the letter "R";
 - 2.18.3.3. On bias-belted tyres, the letter "B".
 - 2.18.4. The conventional number "d" denoting the nominal rim diameter;
 - 2.18.5. Optionally, the letters "IMP" after the nominal rim diameter marking in case of implement tyres;
 - 2.18.6. Optionally, the letters "FRONT" after the nominal rim diameter marking in case of tractor steering wheel tyres;
 - 2.18.7. However for tyres listed in Annex 5 the "tyre size designation" is that shown in the first column of those tables.
 - 2.18.8. The letters "IF" before the nominal section width in case of "Improved Flexion Tyre".
 - 2.18.9. The letters "VF" before the nominal section width in case of "Very High Flexion Tyre".
 - 2.18.10. The letters "CFO" after the nominal rim diameter marking in case of "Improved Flexion" or "Very High Flexion" tractor-drive wheel tyres specifically designed for the equipments of machines to be used in Cyclic Field Operations.
 - 2.18.11. The letters "CHO" after the nominal rim diameter marking in case of standard tractor-drive wheel tyres specifically designed for the equipments of machines to be used in Cyclic Harvesting Operations.
 - 2.18.12. The letters "IND" after the nominal rim diameter marking in case of tyres for construction application (industrial tractors);
 - 2.18.12.1. The letters "IND" may be replaced by the letters "SS" or "NHS" after the nominal rim diameter marking in case of tyres for construction applications as identified in Annex 5 table 10.
 - 2.19. "*Nominal rim diameter (d)*" means a conventional number denoting the nominal diameter of the rim on which a tyre is designed to be mounted and corresponding to the diameter of the rim expressed either by size codes (number below 100 - see table for equivalence with millimeters) or in mm (numbers above 100) but not both;

"d" symbol expressed by codes	Value to be used for the calculation in paras. 6.2.1 and 6.4 (mm)	"d" symbol expressed by codes	Value to be used for the calculation in paras. 6.2.1 and 6.4 (mm)	"d" symbol expressed by codes	Value to be used for the calculation in paras. 6.2.1 and 6.4 (mm)
4	102	19	483	48	1219
5	127	20	508	50	1270
6	152	21	533	52	1321
7	178	22	559	54	1372
8	203	24	610	14.5	368
9	229	25	635	15.5	394
10	254	26	660	16.5	419
11	279	28	711	17.5	445
12	305	30	762	19.5	495
13	330	32	813	20.5	521
14	356	34	864	22.5	572
15	381	36	914	24.5	622
15.3	389	38	965	26.5	673
16	406	40	1016	28.5	724
16.1	409	42	1067	30.5	775
17	432	44	1118	-	-
18	457	46	1168	-	-

- 2.20. "Rim" means the support for a tyre-and-tube assembly, or for a tubeless tyre, on which the tyre beads are seated;
- 2.21. "Theoretical rim" means the notional rim whose width would be equal to X times the nominal section width of a tyre; the value "X" must be specified by the tyre manufacturer or the reference rim width is that mentioned in Annex 5 for the relevant "tyre size designation";
- 2.22. "Measuring rim" means the rim on which a tyre is fitted for the measurement of the dimensions;
- 2.23. "Tractor-drive wheel tyre" means a tyre designed to be fitted to driven axles of agricultural and forestry tractors (vehicles in categories T) suitable for sustained high torque service. The tread pattern of the tyre consists of lugs or cleats;
- 2.23.1. "Improved Flexion Tyre" or "Very High Flexion Tyre" describes a tyre structure in which the carcass is more resistant than that of the corresponding standard tyre.
- 2.24. "Tractor steering wheel tyre" means a tyre designed to be fitted to non-driven axles of agricultural and forestry tractors (motor vehicles in category T). The tread pattern of the tyre generally consists of circumferential grooves and ribs;
- 2.25. "Implement tyre" means a tyre designed primarily for agricultural machines or interchangeable towed equipments (Category S¹ vehicles) or for agricultural trailers (Category R¹ vehicles); however it may also equip either front steering wheels and drive wheels of agricultural and forestry tractors

(Category T¹ vehicles), but it is not suitable for sustained high torque services;

- 2.26. "Traction tyre" means a tyre designed primarily for the equipment of driven axles agricultural machinery, excluding sustained high torque services. The tread pattern of the tyre generally consists of blocks, lugs or cleats. The type of application is identified with the symbol:



- 2.27. "Trailer tyre" means a tyre designed for the equipment of non-driven (trailed) axles of interchangeable towed equipments, agricultural machinery or trailers. The type of application is identified with the symbol:

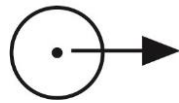

- 2.28. "Mixed applications tyre" means a tyre designed to be fitted to either driven and non-driven axles of interchangeable towed equipments, agricultural machinery or trailers;
- 2.29. "Service description" means the association of a load capacity index with a speed category symbol;
- 2.29.1. In case of implement tyres the service description is supplemented with the relevant symbol for the type of application concerned (traction or trailer) as defined in paragraphs 2.26. and 2.27.
- 2.30. "Supplementary service description" means an additional service description, marked within a circle, to identify a special type of service (load rating and speed category) to which the tyre type is also allowed in addition to the applicable load variation with speed (see Annex 7);
- 2.31. "Load-capacity index" means one number which indicates the load the tyre can carry in single formation at the speed corresponding to the associated speed category and when operated in conformity with the requirements governing utilisation specified by the manufacturer. The list of these indices and their corresponding masses is given in Annex 4;
- 2.32. "Speed category", the reference speed expressed by the speed category symbol as shown in the table below:

<i>Speed category symbol</i>	<i>Reference speed (km/h)</i>
A2	10
A4	20
A6	30
A8	40
B	50
D	65

- 2.33. "Table: Variation of load capacity with speed" means the tables in Annex 7 showing as a function of the category of use, the type of application, the load capacity index and the nominal speed category symbol, the maximum load

- rating variations which a tyre can withstand when used at speeds different from that corresponding to its speed category symbol;
- 2.33.1. The table "Variation of load capacity with speed" is not applicable to the "supplementary service description".
- 2.34. "*Maximum load rating*" means the maximum mass the tyre is rated to carry:
- 2.34.1. It must not exceed the percentage of the value associated with the relevant load capacity index of the tyre as indicated in the table "Load-capacity variation with speed" (see paragraphs 2.30. and 2.33. above), with reference to the category of use, the speed category symbol of the tyre and the speed capability of the vehicle to which the tyre is fitted;
- 2.35. "*Tread groove*" means the space between the adjacent ribs or blocks in the tread pattern;
- 2.36. "*Tread lug (or cleat)*" means the solid-block element protruding from the base of the tread pattern;
- 2.37. "*Special tread*" means a tyre, the tread pattern and structure of which are primarily designed to ensure in marshy areas a better grip than that of a standard tread tyre. The tread pattern of the tyre generally consists of lugs or cleats deeper than those of a standard tyre;
- 2.38. "*Chunking*" means the breaking away of small pieces of rubber from the tread;
- 2.39. "*Cord separation*" means the parting of the cords from their rubber coating;
- 2.40. "*Ply separation*" means the parting of adjacent plies;
- 2.41. "*Tread separation*" means the pulling away of the tread from the carcass;
- 2.42. "*Test rim*" means the rim on which a tyre must be fitted for the performance test;
- 2.43. "*Tyre classification code*" means the optional marking detailed in Annex 10 that identifies the category of use and the particular type of tread pattern and application.
- 2.44. "*Forestry tyre*" means a tyre designed to be fitted to machines or equipments used in forestry applications.
- 2.45. "*Construction application (industrial tractor) tyre*" means a tyre designed to be fitted on industrial tractors, backhoe loaders and other vehicles working in industrial or construction applications (e.g. loaders, excavators, etc.) or some agricultural vehicles (e.g. telehandlers).
- 2.46. NHS (not for highway service) means a tyre primarily designed for use outside of public roads, but suitable for temporary/incidental use on public roads.
- 2.47. SS differentiates tyres for off-highway vehicles such as mini and skid-steer loaders from other tyres which use similar size designations, but may use different rim bead seat configurations.

3. Markings

- 3.1. Tyres submitted for approval shall bear on both sidewalls the following markings:
- 3.1.1. The manufacturer's name or the brand name/trademark;
- 3.1.2. The trade description/commercial name (see paragraph 2.4. of this Regulation). However, the trade description is not required when it coincides with the brand name/trademark.
- 3.1.3. The tyre-size designation;
- 3.1.4. An indication of the structure as follows:
- 3.1.4.1. On diagonal (bias-ply) tyres, no additional marking;
- 3.1.4.2. On radial-ply tyres, optionally, the word "RADIAL";
- 3.1.4.3. On bias-belted tyres, the words "BIAS-BELTED";
- 3.1.5. The "service description";
- 3.1.5.1. In the case of implement tyre, the service description supplemented with the relevant application symbol;
- 3.1.5.2. In the case of implement tyre for mixed applications, two service descriptions one for "trailer" applications and the other for "traction" applications, each supplemented with the relevant symbol (see paragraphs 2.26. and 2.27. above) as follows:

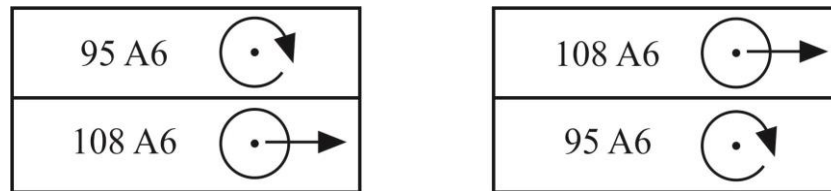

- 3.1.6. The supplementary service description, if applicable.
- 3.1.7. The inscription "DEEP" (or "R-2" or "LS-3" or "HF-3" or "HF-4") in the case of a special tread tyre;
- 3.1.7.1. "DEEP" and "R-2" identify special tread tyres for tractor drive wheels.
- 3.1.8. The inscriptions "F-1" or "F-2" or "F-3" in the case of a tractor steering wheel tyre that is not already marked as per paragraph 2.18.6. above;
- 3.1.9. The inscriptions "LS-1", "LS-2", "LS-3" or "LS-4" in the case of log-skidder tyres for forestry machines.
- 3.1.9.1. "LS-3" identifies special tread tyres.
- 3.1.9.2. The inscription 'I-3' for implement tyres with traction tread as identified in Annex 5, Tables 5 and 6.
- 3.1.10. The inscription "IMPLEMENT" in the case of an implement tyre that is not already marked as per paragraph 2.18.5. above;
- 3.1.11. The word "TUBELESS" if the tyre is designed for use without an inner tube;

- 3.1.12. The inscription "... bar MAX." (or "... kPa MAX") inside the pictogram shown in Annex 11, to notify the cold inflation pressure that shall not be exceeded for bead seating during tyre mounting.
- 3.1.13. The inscription "R-3" for tractor drive wheel tyres with shallow tread as identified in Annex 5, Table 2.
- 3.1.14. The inscription "R-4" in the case of a construction application tyre, identified in Annex 5, Table 9, that is not already marked as per paragraph 2.18.12. above.
- 3.1.15. The inscriptions "HF-1", "HF-2", "HF-3", or "HF-4" in the case of high-flotation tyres for tractor drive wheels or forestry machines listed in Annex 5 Table 7.
- 3.1.15.1. "HF-3" and "HF-4" identify special tread tyres.
- 3.1.16. An indication, in kPa, of the inflation pressure to be adopted for measurements (as specified in Annex 6 paragraph 1) and for the tyre resistance to bursting (as specified in Annex 8 paragraph 2.1) and, if applicable, the load/speed test (as specified in Annex 9 paragraph 2.3). This marking shall be preceded by the symbol "@" or the word "at" (e.g. "@ 240 kPa" or "at 240 kPa") and be placed near the service description, either after or below.
- 3.1.16.1. However, this indication shall not be mandatory on any tyre first type approved before the entry into force of Supplement 16 to this Regulation.
- 3.2. Tyres submitted for approval shall bear, on one sidewall only, the following:
 - 3.2.1. The date of manufacture in the form of a group of four digits, the first two showing the week and the last two the year of manufacture
 - 3.2.2. A free space sufficiently large to accommodate an approval mark as shown in Annex 2 to this Regulation.
- 3.3. All markings shall be clearly and legibly moulded and produced as part of the process during manufacture. The use of branding or other methods of marking after completion of the original manufacturing process is not permitted.
- 3.4. Annex 3 gives examples of the arrangement of tyre markings.

4. Application for approval

- 4.1. The application for approval of a type of tyre for agricultural and forestry services with regard to this Regulation shall be submitted by the tyre manufacturer or by his duly accredited representative. It shall specify:
 - 4.1.1. The tyre-size designation;
 - 4.1.2. The manufacturer's name;
 - 4.1.2.1. The brand name(s)/trademark(s);
 - 4.1.2.2. The trade description(s)/commercial name(s).
 - 4.1.3. The category of use as defined in paragraph 2.1. of this Regulation;
 - 4.1.4. The structure;
 - 4.1.5. The speed category symbol;

- 4.1.6. The load-capacity index of the tyre, specifying in case of implement tyres that for traction (only) and that for trailer application, if applicable;
- 4.1.7. Whether the tyre is to be fitted with or without an inner tube;
- 4.1.8. The supplementary service description, if applicable;
- 4.1.9. The tyre/rim configuration;
- 4.1.10. The rim to be used for measurements and the rim to be used for tests;
- 4.1.11. The rim(s) on which the tyre can be mounted;
- 4.1.12. The inflation pressure (bar or kPa) for measurements as detailed in paragraph 3.1.16.;
- 4.1.13. The factor X referred to in paragraph 2.21. or the applicable table of Annex 5;
- 4.1.14. The cold inflation pressure that shall not be exceeded for bead seating during tyre mounting, as specified by the tyre manufacturer for the tyre type;
- 4.1.15. The test pressure, in kPa (or in bar) as detailed in paragraph 3.1.16..
- 4.2. On request of the Type Approval Authority, the tyre manufacturer must also submit a complete technical file for each tyre type containing in particular sketches or photographs (three copies) to identify the tread pattern and the envelope of the inflated tyre mounted on the measuring rim showing the relevant dimensions (see paragraphs 6.1. and 6.2. below) of the component type submitted for approval. It shall also either contain the test report issued by an approved test laboratory or be accompanied by one sample of the tyre type, as requested by the Type Approval Authority.

5. Approval

- 5.1. If the type of tyre submitted for approval in pursuance to this Regulation meets the requirements of paragraph 6. below, approval of that type of tyre shall be granted.
- 5.2. An approval number shall be assigned to each type approved. Its first two digits (at present 00, for the Regulation in its original form) shall indicate the series of amendments incorporating the most recent major technical amendments made to the Regulation at the time of issue of the approval. The same Contracting Party shall not assign the same number to another type of tyre covered by this Regulation.
- 5.3. Notice of approval or extension or refusal or withdrawal of approval or production definitively discontinued of a type of tyre pursuant to this Regulation shall be communicated to the Parties to the 1958 Agreement which apply this Regulation, by means of a form conforming to the model in Annex 1 to this Regulation (E/ECE/TRANS/505/Rev.3, Art. 5).
- 5.4. There shall be affixed, conspicuously, to every tyre conforming to a type of tyre approved under this Regulation, in the space referred to in paragraph 3.2.2. above and in addition to the markings prescribed in paragraphs 3.1. and 3.2. above, an international approval mark consisting of:

- 5.4.1. A circle surrounding the letter "E" followed by the distinguishing number of the country which has granted approval.²
- 5.4.2. The number of this Regulation followed by the letter "R", a dash and the type approval number.
- 5.5. The approval mark shall be clearly legible and be indelible.
- 5.6. Annex 2 to this Regulation gives an example of the arrangement of the approval mark.

6. Requirements

- 6.1. Section width of a tyre
 - 6.1.1. The section width shall be obtained by means of the following formula:
$$S = S1 + K (A - A1),$$
Where:
S is the "section width" rounded to the nearest millimetre related to the measuring rim;
S1 is "the nominal section width" in mm, as shown on the sidewall of the tyre in the tyre designation as prescribed;
A is the width (expressed in mm)³ of the measuring rim, as shown by the manufacturer in the descriptive note;
A1 is the width of the theoretical rim; it is taken to equal S1 multiplied by the factor X as specified by the tyre manufacturer; and K is taken to equal 0.4.
 - 6.1.2. However, for the types of tyre for which the size designation is given in the first column of the tables in Annex 5, the theoretical rim width code A1³ and the nominal section width S1 are given opposite the tyre size designation in those tables.
- 6.2. Outer diameter of a tyre
 - 6.2.1. Except as provided by paragraph 6.2.2., the outer diameter of a tyre is calculated by the following formula:
$$D = d + 2 H$$
Where:
D is the outer diameter expressed in mm;
d is the conventional number denoting the nominal rim diameter expressed in mm (see paragraph 2.19.);

² The distinguishing numbers of the Contracting Parties to the 1958 Agreement are reproduced in Annex 3 to the Consolidated Resolution on the Construction of Vehicles (R.E.3), document ECE/TRANS/WP.29/78/Rev.6 - www.unece.org/trans/main/wp29/wp29wgs/wp29gen/wp29resolutions.html

³ Conversion factor from code to mm is 25.4.

H is the nominal section height rounded to the nearest millimetre and is equal to:

$$H = 0.01 \cdot Ra \cdot S1$$

Where:

Ra is the nominal aspect ratio;

S1 is the "nominal section width" in mm.

All as shown on the sidewall of the tyre in the tyre-size designation in conformity with the requirements of paragraph 2.18.

6.2.2. However, for the types of tyres for which the size designation is given in the first column of the tables of Annex 5 the outer diameter D and the nominal rim diameter (d) expressed in mm are given opposite the tyre size designation in those tables.

6.3. Tyre section width: specification of tolerances

6.3.1. The overall width of a tyre may be less than the section width determined pursuant to paragraph 6.1., or shown in Annex 5;

6.3.2. The overall width of a tyre may not exceed the section width determined pursuant to paragraph 6.1. by more than the following:

Radial construction: +5 per cent

Diagonal (bias) construction: +8 per cent

Calculated value to be rounded to the nearest mm;

6.3.3. However, for the types of tyre for which the size designation is given in the first column of the tables in Annex 5, the allowed percentages are those given in the relevant tables, if any.

6.4. Tyre outer diameter: specification of tolerances

6.4.1. The outer diameter of a tyre must not be outside the values D min and D max obtained from the following formulae:

$$D \text{ min} = d + 2 \cdot H_{\text{min}}$$

$$D \text{ max} = d + 2 \cdot H_{\text{max}}$$

Where

$H_{\text{min}} = H \cdot a$, rounded to the nearest mm

$H_{\text{max}} = H \cdot b$, rounded to the nearest mm

"H" and "d" are as defined in paragraph 6.2.1.

Coefficients "a" and "b" are specified in paragraph 6.4.2.

6.4.1.1. For sizes listed in Annex 5: $H = 0,5 (D - d)$
(for references see paragraph 6.2. above).

6.4.2. Coefficients "a" and "b" are respectively:

<i>Category of use</i>	<i>Radial</i>		<i>Diagonal (bias)</i>	
	<i>a</i>	<i>b</i>	<i>a</i>	<i>b</i>
Steering wheels	0,96	1,04	0,96	1,07
Tractor drive wheels and forestry machines - normal	0,96	1,04	0,96	1,07
Tractor drive wheels and forestry machines – special	1,00	1,12	1,00	1,12
Implement	0,96	1,04	0,96	1,07
Construction Applications	0,96	1,04	0,97	1,07

6.4.3. However, for the types of tyre for which the size designation is given in the first column of the tables in Annex 5, the allowed percentages are those given in the relevant tables, if any.

6.5. Test procedures

6.5.1. The actual dimensions of tyres are measured as prescribed in Annex 6.

6.5.2. The test procedure to assess the resistance of the tyre to burst is described in Annex 8.

6.5.2.1. A tyre which, after undergoing the relevant test to assess the resistance to burst, does not exhibit any tread separation, ply separation, cord separation, broken beads or broken cords is deemed to have passed the test. The tyre tested shall not be used for any other tests.

6.5.3. The test procedures to assess the suitability of the tyre for the claimed performances are described in Annex 9.

6.5.3.1. A tyre which, after undergoing the relevant load/speed test, does not exhibit any tread separation, ply separation, cord separation or broken cords is deemed to have passed the test. The tyre tested shall not be used for any other tests.

6.5.3.2. A tyre which, after undergoing the relevant load/speed test, does exhibit chunking, due to the specific test conditions is deemed to have passed the test.

6.5.4. Where a tyre manufacturer produces a range of tyres it is not considered necessary to carry out tests on every type of tyre in the range.

7. Modification of tyre type and extension of approval

7.1. Every modification of a tyre type shall be notified to the Type Approval Authority which approved the tyre type. That authority may then either:

7.1.1. Consider that the modifications made are unlikely to have an appreciable adverse effect and that in any case the tyre still meet the requirements; or

7.1.2. Require a further test report from the Technical Service responsible for carrying out the tests.

- 7.2. A modification of the tread pattern of the tyre shall not be considered to necessitate a repetition of the tests prescribed in paragraph 6. of this Regulation.
- 7.3. Confirmation or refusal of approval, specifying the alterations, shall be communicated by the procedure specified in paragraph 5.3. above to the Parties to the Agreement which apply this Regulation.
- 7.4. The Type Approval Authority issuing the extension of approval shall assign a series number for such an extension and inform thereof the other Parties to the 1958 Agreement applying this Regulation by means of a communication form conforming to the model in Annex 1 to this Regulation.

8. Conformity of production

The conformity of production procedures shall comply with those set out in the Agreement, Schedule 1 (E/ECE/TRANS/505/Rev.3), with the following requirements:

- 8.1. The tyres approved under this Regulation shall be so manufactured as to conform to the type approved by meeting the requirements set forth in paragraph 6. above.
- 8.2. The Type Approval Authority which has granted type approval may at any time verify the conformity control methods applied in each production facility. For each production facility, the normal frequency of these verifications shall be once every two years.

9. Penalties for non-conformity of production

- 9.1. The approval granted in respect of a type of tyre pursuant to this Regulation may be withdrawn if the requirement laid down in paragraph 8.1. above is not complied with or if the tyres taken from the series have failed to pass the tests prescribed in that paragraph.
- 9.2. If a Party to the Agreement which applies this Regulation withdraws an approval it has previously granted, it shall forthwith so notify the other Contracting Parties which apply this Regulation, by means of a communication form conforming to the model in Annex 1 to this Regulation.

10. Production definitively discontinued

If the holder of an approval completely ceases to manufacture a type of tyre approved in accordance with this Regulation, he shall so inform the Type Approval Authority which granted the approval. Upon receiving the relevant communication that Authority shall inform thereof the other Parties to the Agreement which apply this Regulation by means of a communication form conforming to the model in Annex 1 to this Regulation.

11. Names and addresses of Technical Services responsible for conducting approval tests, of test laboratories, and of Type Approval Authorities

- 11.1. The Contracting Parties to the 1958 Agreement which apply this Regulation shall communicate to the United Nations Secretariat the names and addresses of the Technical Services responsible for conducting approval tests and, where applicable, of the approved test laboratories and of the Type Approval Authorities which grant approval and to which forms certifying approval, or extension of approval, or refusal of approval or withdrawal of approval or production definitively discontinued, issued in other countries, are to be sent.
- 11.2. The Contracting Parties to the 1958 Agreement which apply this Regulation may designate laboratories of tyre manufacturers as approved test laboratories.
- 11.3. Where a Contracting Party to the 1958 Agreement applies paragraph 11.2. above, it may, if it so desires, be represented at the tests by one or more persons of its choice.

Explanatory figure
Type cross section

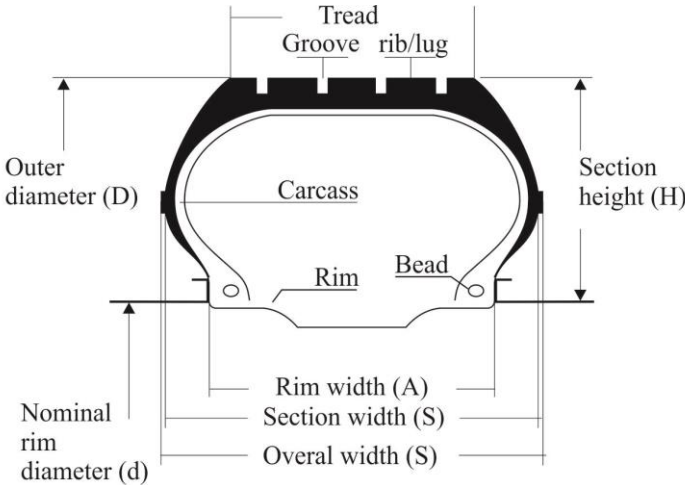

Lug (cleat) tread pattern

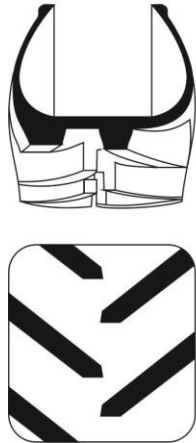

Circumferencial Rib tread pattern

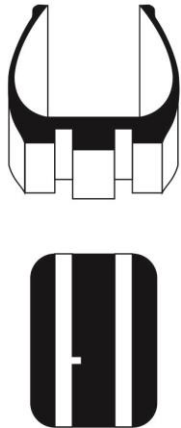

Annex 1

Communication

(Maximum format: A4 (210 x 297 mm))



issued by :

Name of
administration:

.....
.....
.....

concerning:² Approval granted
 Approval extended
 Approval refused
 Approval withdrawn
 Production definitively discontinued

of a type of tyre for motor vehicles pursuant to UN Regulation No. 106

Approval No.: Extension No. :

1. Manufacturer's name and address:
2. Tyre type designation³.....
- 2.1. Brand-name(s)/trademark(s):
- 2.2. Trade description(s)/ Commercial name(s):
3. If applicable, name and address of manufacturer's representative:
-
4. Summarized description:
- 4.1. Size of tyre:
- 4.2. Category of use:
- 4.3. Structure: diagonal or bias-ply/bias belted/radial²
- 4.4. Speed category symbol:
- 4.5. Load-capacity index:.....
- 4.5.1. For traction (implement only):
- 4.5.2. For trailer (implement only):.....

¹ Distinguishing number of the country which has granted/extended/refused/withdrawn approval (see approval provisions in the Regulation).

² Strike out what does not apply.

³ A list of brand name(s)/trademark(s) or Trade description(s)/ Commercial name(s) may be annexed to this communication.

- 4.6. Whether the tyre is to be fitted with or without an inner tube.....
.....
- 4.7. The supplementary service description, if applicable:
.....
5. Technical Service and, where applicable, test laboratory approved for purposes
of approval or of verification of conformity:
6. Date of report issued by that Service:
7. Number of report issued by that Service:
8. Reason(s) of extension (if applicable):
9. Any remarks:.....
.....
10. Place:.....
11. Date:.....
12. Signature:
13. Annexed to this communication is a list of documents in the approval file deposited
at the Type Approval Authorities having delivered the approval and which can be
obtained upon request

Annex 2

Arrangement of approval mark



$a = 12 \text{ mm min}$

The above approval mark affixed to a tyre shows that the type of tyre concerned has been approved in the Netherlands (E 4) pursuant to UN Regulation No. 106 under approval number 002439. The first two digits of the approval number indicate that the approval was granted in accordance with the requirements of UN Regulation No. 106 in its original form.

Note: The approval number must be placed close to the circle and either above or below the "E" or to the left or right of that letter. The digits of the approval number must be on the same side of the "E" and face in the same direction. The use of Roman numerals as approval numbers should be avoided so as to prevent any confusion with other symbols.

Annex 3

Arrangement of tyre markings

(See paragraphs 3.1. and 3.2. of this Regulation)

Part A: Drive wheel tyres for agricultural tractors

Example of the markings to be borne by types of tyres complying with this Regulation

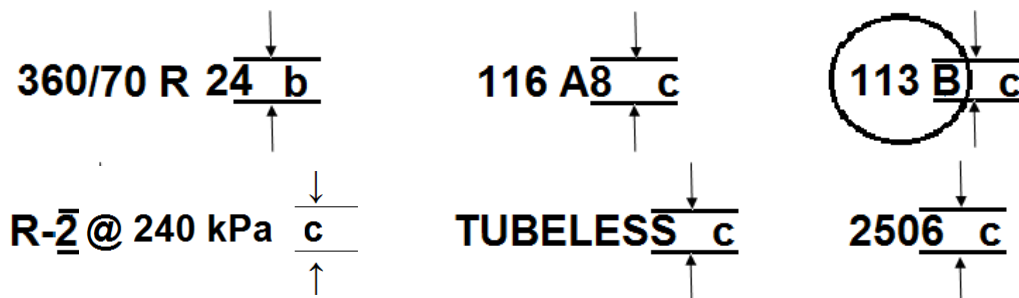

Minimum heights of markings (mm)

Tyres of nominal section width (mm)	Tyres of rim diameter code		
	Up to 12	13 to 19,5	20 and above
up to 130	b = 4 c = 4	b = 6 c = 4	b = 9 c = 4
135 to 235	b = 6 c = 4	b = 6 c = 4	b = 9 c = 4
240 and above	b = 9 c = 4	b = 9 c = 4	b = 9 c = 4

These markings define a drive wheel tyre:

- Having a nominal section width of 360;
- Having a nominal aspect ratio of 70;
- Of radial ply structure (R);
- Having a nominal rim diameter of 610 for which the code is 24;
- Having a load capacity of 1250 kg, corresponding to load index 116 in Annex 4;
- Classified in the speed category A8 (reference speed 40 km/h);
- Allowed to be used additionally at 50 km/h (speed category symbol B) with a load, capacity of 1150 kg corresponding to the load capacity index 113 shown in Annex 4;

- (h) For fitting without an inner tube ("tubeless");
- (i) Having a special tread ("R-2");
- (j) Manufactured during the twenty-fifth week of the year 2006 (see paragraph 3.2. of this Regulation);
- (k) Requiring to be inflated to 240 kPa for measurements and tyre resistance to burst and, if applicable, load/speed test.

The positioning and order of the markings constituting the tyre designation are as follows:

- (a) The size designation, comprising the prefix (if any), the nominal section width, the nominal aspect ratio, the type-of-structure symbol (where applicable) and the nominal rim diameter, must be grouped as shown in the examples:
360/70 R 24, IF 360/70 R 24, VF 360/70 R 24, IF 800/65 R 32 CFO, 800/70 R 24 CHO;
- (b) The service description (load index and the speed category symbol) is placed near the size designation. It may either precede or follow it or be placed above or below it;
- (c) The symbols "TUBELESS", "R-2" or "DEEP", the optional word "RADIAL" and the date of production may be at a distance from the size designation;
- (d) The marking of the additional service description inside the circle may show either the speed category symbol after or below the load index;
- (e) The inflation pressure to be used for measurement and tests is placed near the service description. It may either follow or be placed below it.

Part B: Steering wheel tyres for agricultural and forestry tractors

Example of the markings to be borne by types of tyres complying with this Regulation

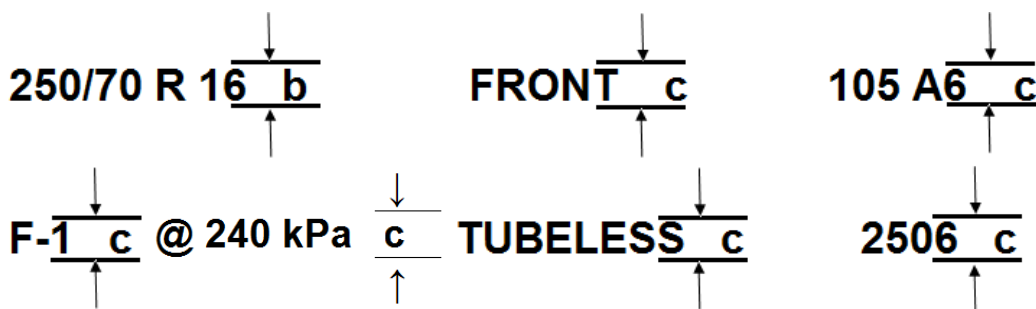

Minimum heights of markings (mm)

Tyres of nominal section width (mm)	Tyres of rim diameter code		
	Up to 12	13 to 19.5	20 and above
up to 130	b = 4 c = 4	b = 6 c = 4	b = 9 c = 4
135 to 235	b = 6 c = 4	b = 6 c = 4	b = 9 c = 4
240 and above	b = 9 c = 4	b = 9 c = 4	b = 9 c = 4

These markings define a steering wheel tyre:

- (a) Having a nominal section width of 250;
- (b) Having a nominal aspect ratio of 70;
- (c) Of radial-ply structure (R);
- (d) Having a nominal rim diameter of 405 mm, for which the code is 16, designed for the equipment of non-driven steering axles of agricultural tractors (FRONT);
- (e) Having load capacities of 925 kg, corresponding to the load capacity index 105 shown in Annex 4;
- (f) Classified in the nominal speed category A6 (reference speed 30 km/h);
- (g) For fitting without an inner tube "tubeless";
- (h) Manufactured during the twenty-fifth week of the year 2006 (see paragraph 3.2. of this Regulation);
- (i) Requiring to be inflated to 240 kPa for measurements and tyre resistance to burst.

The positioning and order of the markings constituting the tyre designation are as follows:

- (a) The size designation, comprising the nominal section width, the nominal aspect ratio, the type-of-structure symbol (where applicable), the nominal rim diameter and, optionally the letters "FRONT", must be grouped as shown in the above example: 250/70 R 16 FRONT;
- (b) The service description (the load index and the speed category symbol) is placed together near the size designation. It may either precede or follow it or be placed above or below it;
- (c) The symbol "TUBELESS", the optional word "RADIAL", the optional symbol "F-1", and the date of manufacture may be at a distance from the size designation;
- (d) The inflation pressure to be used for measurement and tests is placed near the service description. It may either follow or be placed below it.

Part C: Implement tyres

Example of the markings to be borne by types of tyres complying with this Regulation

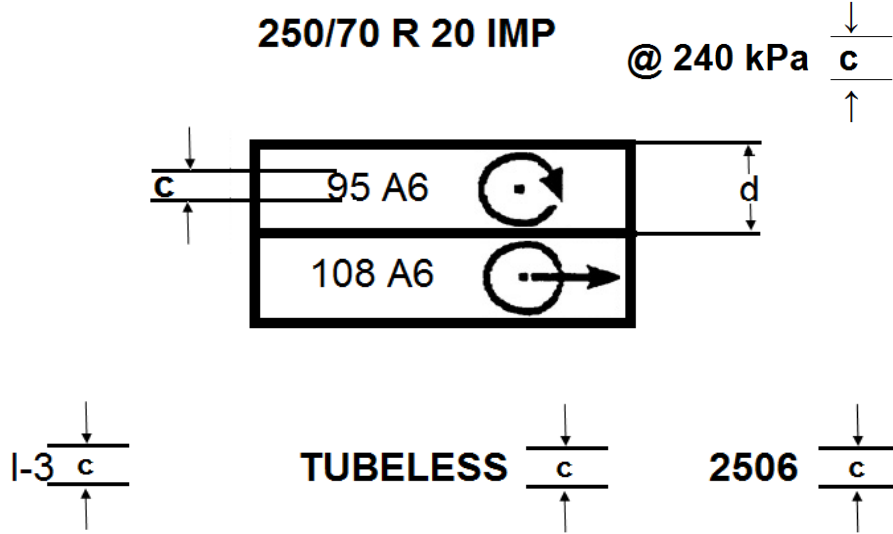

Minimum heights of markings (mm)

Tyres of nominal section width (mm)	Tyres of rim diameter code		
	Up to 12	13 to 19.5	20 and above
up to 130	b = 4 c = 4 d = 7	b = 6 c = 4 d = 12	b = 9 c = 4 d = 12
135 to 235	b = 6 c = 4 d = 12	b = 6 c = 4 d = 12	b = 9 c = 4 d = 12
240 and above	b = 9 c = 4 d = 12	b = 9 c = 4 d = 12	b = 9 c = 4 d = 12

These markings define an implement tyre:

- (a) Having a nominal section width of 250;
- (b) Having a nominal aspect ratio of 70;
- (c) Of radial-ply structure (R);
- (d) Having a nominal rim diameter of 508 mm, for which the code is 20;
- (e) Designed primarily for the equipment of implements, agricultural machinery or agricultural trailers (IMP);
- (f) Having load capacities of 690 kg corresponding to the load capacity index 95 shown in Annex 4 when used on driven axles (traction application), as identified by the appropriate symbol;

- (g) Having load capacities of 1,000 kg when used on non-driven axles (trailer application) corresponding to the load capacity index 108 shown in Annex 4, as identified by the appropriate symbol;
- (h) Both applications being classified in the nominal speed category A6 (reference speed 30 km/h);
- (i) For fitting without an inner tube "tubeless";
- (j) Manufactured during the twenty-fifth week of the year 2006 (see paragraph 3.2. of the Regulation);
- (k) Requiring to be inflated to 240 kPa for measurements and tyre resistance to burst and, if applicable, load/speed test.

The positioning and order of the markings constituting the tyre designation are as follows:

- (a) The size designation, comprising the nominal section width, the nominal aspect ratio, the type-of-structure symbol (where applicable), the nominal rim diameter and optionally the letters 'IMP' must be grouped as shown in the above example: 250/70 R 20 IMP;
- (b) The service description (the load index and the speed category symbol) and the relevant type of application symbol are placed together near the size designation. They may either precede or follow it or be placed above or below it;
- (c) The symbol "TUBELESS", I-3 if any, the optional word "RADIAL", the optional word "IMPLEMENT" and the date of manufacture may be at a distance from the size designation;
- (d) The inflation pressure to be used for measurement and tests is placed near the service description. It may either follow or be placed below it.

Part D: Tyres for forestry machines

Example of the markings to be borne by types of tyres complying with this Regulation

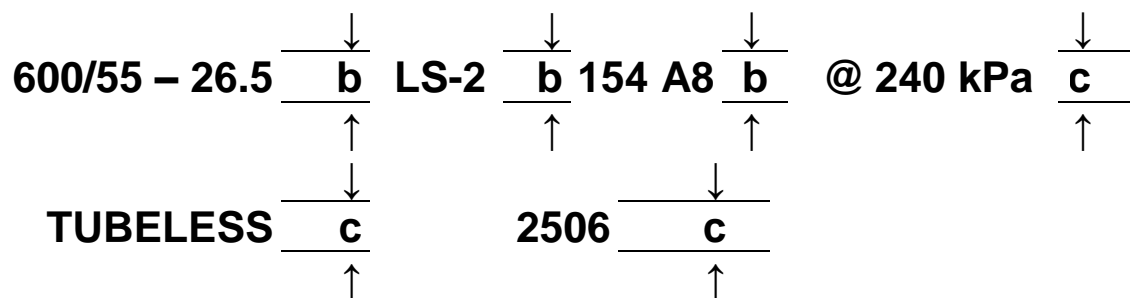

Minimum heights of markings: b: 9 mm c: 4 mm

These markings define a tyre for forestry machines:

- (a) Having a nominal section width of 600;
- (b) Having a nominal aspect ratio of 55;
- (c) Of diagonal ply structure (-);

- (f) Classified in the speed category A8 (reference speed 40 km/h) ;
- (g) Allowed to be used additionally at 50 km/h (speed category symbol B) with a load, capacity of 3650 kg corresponding to the load capacity index 153 shown in Annex 4;
- (h) For fitting without an inner tube ("TUBELESS");
- (i) Manufactured during the twenty-fifth week of the year 2013 (see paragraph 3.2. of the Regulation);
- (j) Requiring to be inflated to 240 kPa for measurements and tyre resistance to burst and, if applicable, load/speed test.

The positioning and order of the markings constituting the tyre designation are as follows:

- (a) The size designation, comprising the nominal section width, the nominal aspect ratio, the type of structure symbol, the nominal rim diameter and the suffix IND, must be grouped as shown in the above example: 400/80 – 24 IND;
- (b) The service description (load index and the speed category symbol) is placed near the size designation. It may either precede or follow it or be placed above or below it;
- (c) The symbols "TUBELESS", "R-4" if applicable, and the date of production may be at a distance from the size designation";
- (d) The marking of the additional Service Description inside the circle, if any, may show either the speed category symbol after or below the load index;
- (e) The inflation pressure to be used for measurement and tests is placed near the service description. It may either follow or be placed below it.

Annex 4

List of load capacity indices (LI) and corresponding maximum mass to be carried (kg)

(See paragraph 2.28. of this Regulation)

LI	kg	LI	kg	LI	kg	LI	kg	LI	kg	LI	kg	LI	kg
0	45	40	140	80	450	120	1 400	160	4 500	200	14 000	240	45 000
1	46.2	41	145	81	462	121	1 450	161	4 625	201	14 500	241	46 250
2	47.5	42	150	82	475	122	1 500	162	4 750	202	15 000	242	47 500
3	48.7	43	155	83	487	123	1 550	163	4 875	203	15 500	243	48 750
4	50	44	160	84	500	124	1 600	164	5 000	204	16 000	244	50 000
5	51.5	45	165	85	515	125	1 650	165	5 150	205	16 500	245	51 500
6	53	46	170	86	530	126	1 700	166	5 300	206	17 000	246	53 000
7	54.5	47	175	87	545	127	1 750	167	5 450	207	17 500	247	54 500
8	56	48	180	88	560	128	1 800	168	5 600	208	18 000	248	56 000
9	58	49	185	89	580	129	1 850	169	5 800	209	18 500	249	58 000
10	60	50	190	90	600	130	1 900	170	6 000	210	19 000	250	60 000
11	61.5	51	195	91	615	131	1 950	171	6 150	211	19 500	251	61 500
12	63	52	200	92	630	132	2 000	172	6 300	212	20 000	252	63 000
13	65	53	206	93	650	133	2 060	173	6 500	213	20 600	253	65 000
14	67	54	212	94	670	134	2 120	174	6 700	214	21 200	254	67 000
15	69	55	218	95	690	135	2 180	175	6 900	215	21 800	255	69 000
16	71	56	224	96	710	136	2 240	176	7 100	216	22 400	256	71 000
17	73	57	230	97	730	137	2 300	177	7 300	217	23 000	257	73 000
18	75	58	236	98	750	138	2 360	178	7 500	218	23 600	258	75 000
19	77.5	59	243	99	775	139	2 430	179	7 750	219	24 300	259	77 500
20	80	60	250	100	800	140	2 500	180	8 000	220	25 000	260	80 000
21	82.5	61	257	101	825	141	2 575	181	8 250	221	25 750	261	82 500
22	85	62	265	102	850	142	2 650	182	8 500	222	26 500	262	85 000
23	87.5	63	272	103	875	143	2 725	183	8 750	223	27 250	263	87 500
24	90	64	280	104	900	144	2 800	184	9 000	224	28 000	264	90 000
25	92.5	65	290	105	925	145	2 900	185	9 250	225	29 000	265	92 500
26	95	66	300	106	950	146	3 000	186	9 500	226	30 000	266	95 000
27	97.5	67	307	107	975	147	3 075	187	9 750	227	30 750	267	97 500
28	100	68	315	108	1 000	148	3 150	188	10 000	228	31 500	268	100 000
29	103	69	325	109	1 030	149	3 250	189	10 300	229	32 500	269	103 000
30	106	70	335	110	1 060	150	3 350	190	10 600	230	33 500	270	106 000
31	109	71	345	111	1 090	151	3 450	191	10 900	231	34 500	271	109 000
32	112	72	355	112	1 120	152	3 550	192	11 200	232	35 500	272	112 000
33	115	73	365	113	1 150	153	3 650	193	11 500	233	36 500	273	115 000
34	118	74	375	114	1 180	154	3 750	194	11 800	234	37 500	274	118 000
35	121	75	387	115	1 215	155	3 875	195	12 150	235	38 750	275	121 500
36	125	76	400	116	1 250	156	4 000	196	12 500	236	40 000	276	125 000
37	128	77	412	117	1 285	157	4 125	197	12 850	237	41 250	277	128 500
38	132	78	425	118	1 320	158	4 250	198	13 200	238	42 500	278	132 000
39	136	79	437	119	1 360	159	4 375	199	13 600	239	43 750	279	136 000

Annex 5

Theoretical rim, outer diameter and nominal section width of tyres of certain size designations

Table 1 (1 of 2)
Agricultural steering wheels - Normal and low Section sizes

Tyre size designation	Theoretical rim width code (A1)	Nominal width (S1) (mm)	Overall diameter (D) (mm)		Nominal width (d) (mm)
				(*)	
4.00 - 9	3	112	460	-	229
4.00 - 12	3	112	535	526	305
4.00 - 15	3	112	610	602	381
4.00 - 16	3	112	630	-	406
4.00 - 19	3	112	712	704	483
4.50 - 10	3	121	505	-	254
4.50 - 16	3	122	655	-	406
4.50 - 19	3	122	736	-	483
5.00 - 10	3	130	530	-	254
5.00 - 12	3	130	580	-	305
5.00 - 15	4	140	655	649	381
5.00 - 16	4	140	680	-	406
5.50 - 16	4	150	710	694	406
6.00 - 14	5	169	688	669	356
6.00 - 16	4,5	165	735	720	406
6.00 - 18	4	160	790	-	457
6.00 - 19	4,5	165	814	796	483
6.00 - 20	4,5	165	840	-	508
6.50 - 10	4,5	175	608	-	254
6.50 - 16	4,5	175	760	739	406
6.50 - 20	4,5	175	865	-	508
7.50 - 16	5,5	205	805	782	406
7.50 - 18	5,5	205	860	833	457
7.50 - 20	5,5	205	915	883	508
8.00 - 16	5,5	211	813	813	406
9.00 - 16	6	234	855	827	406
9.50 - 20	7	254	978	-	508
10.00 - 16	8	274	895	-	406
11.00 - 16	10	315	965	935	406
11.00 - 24	10	315	1 170	1138	610

Table 1 (2 of 2)
Agricultural steering wheels - Normal and low section sizes

Tyre size designation	Theoretical rim width code (A1)	Nominal width (S1) (mm)	Overall diameter (D) (mm)		Nominal width (d) (mm)
				(*)	
Low Section					
7.5L - 15	6	210	745	-	381
8.25/85 - 15	6	210	745	-	381
9.5L - 15	8	240	785	-	381
9.5/85 - 15	8	240	785	-	381
11L - 15	8	280	815	783	381
11.5/75 - 15	8	280	815	-	381
7.5L - 16	6	208	746	-	406
11L - 16	8	279	840	808	406
11.5/80 - 15.3	9	290	845	-	389
14L - 16.1	11	360	985	950	409
14.0/80 - 16.1	11	360	985	-	409
14.5/75 - 16.1	11	373	940	904	409
16.5L - 16.1	14	419	1 072	1031	409

Notes:

1. Agricultural steering wheels tyres are identified either by suffix "Front" placed after the Tyre size designation (e.g. 4.00 - 9 Front) or by one of the following additional markings added to the Tyre sidewalls: "F-1", "F-2" or "F-3".
2. Tyres of radial structure are identified by means of the letter "R" in place of " - " (e.g. 4.00R9).
3. Overall diameters (D) in column (*) apply to tyres for industrial service (construction applications) marked with classification code "F-3" – see paragraph 3.1.8 of this Regulation. These tyres may be marked with the suffix "IND" instead of "Front".
4. For diagonal tyres marked on the tyre sidewall with classification code "F-1" (see paragraph 3.1.8. of this regulation), the overall diameter (D) is to be increased by 12 mm.

Table 2 (1 of 5)
Drive wheel tyres for agricultural tractors - Normal section sizes

Tyre size designation	Theoretical rim width code (A1)	Nominal section width (S1) (mm)		Overall diameter (D) (mm)		Nominal rim diameter (d) (mm)
		Radial	Diagonal	Radial	Diagonal (*)	
4.00-7	3	-	112	-	410	178
4.00-8	3	-	112	-	435	203
4.00-9	3	-	112	-	460	229
4.00-10	3	-	112	-	485	254
4.00-12	3	-	112	-	535	305
4.00-18	3	-	112	-	690	457
4.50-10	3	-	121	-	505	254
5.0 -10	4	-	135	-	505	254
5.00-10	3	-	130	-	530	254
5.00-12	4	-	145	-	580	305
5.00-15	4	-	145	-	645	381
6.00-12	4	-	160	-	635	305
6.00-16	4	-	160	-	735	406
6.5-15	5	-	167	-	685	381
6.50-16	5	-	175	-	760	406
7.00-16	6	-	183	-	742	406
7.00-18	6	-	183	-	792	457
7.50-16	5,5	205	-	805	-	406
7.50-18	5,5	205	205	880	860	457
8.00-20	6	-	220	-	965	508
5-12	4	-	127	-	545	305
5-14	4	-	127	-	595	356
5-26	4	-	127	-	900	660
6-10	5	-	157	-	550	254
6-12	5	-	157	-	600	305
6-14	5	-	157	-	650	356
7-14	5	-	173	-	690	356
7-16	6	-	183	-	740	406
8-16	6	-	201	-	790	406
8-18	7	-	211	-	840	457
7.2-20	6	-	183	-	845	508
7.2-24	6	-	183	-	945	610
7.2-30	6	-	183	-	1 095	762
7.2-36	6	-	183	-	1 250	914
7.2-40	6	-	183	-	1 350	1 016
8.3-16	7	-	211	-	790	406

Table 2 (2 of 5)
Drive wheel tyres for agricultural tractors - Normal section sizes

Tyre size designation	Theoretical rim width code (A1)	Nominal section width (S1) (mm)		Overall diameter (D) (mm)		Nominal rim diameter (d) (mm)
		Radial	Diagonal	Radial	Diagonal (*)	
8.3-20	7	-	211	-	890	508
8.3-22	7	-	211	-	940	559
8.3-24	7	211	211	985	995	610
8.3-26	7	-	211	-	1 045	660
8.3-28	7	-	211	-	1 095	711
8.3-32	7	211	211	1 190	1 195	813
8.3-36	7	211	211	1 290	1 300	914
8.3-38	7	-	211	-	1 350	965
8.3-42	7	211	211	1 440	1 450	1 067
8.3-44	7	211	211	1 495	1 500	1 118
9.5-16	8	-	241	-	845	406
9.5-18	8	-	241	-	895	457
9.5-20	8	241	241	940	945	508
9.5-22	8	-	241	-	995	559
9.5-24	8	241	241	1 040	1 050	610
9.5-26	8	-	241	-	1 100	660
9.5-28	8	241	-	1 140	-	711
9.5-32	8	-	241	-	1 250	813
9.5-36	8	241	241	1 345	1 355	914
9.5-38	8	-	241	-	1 405	965
9.5-42	8	-	241	-	1 505	1 067
9.5-44	8	241	241	1 550	1 555	1 118
9.5-48	8	241	241	1 650	1 655	1 219

Table 2 (3 of 5)
Drive wheel tyres for agricultural tractors - Normal section sizes

Tyre size designation	Theoretical rim width code (A1)	Nominal section width (S1) (mm)		Overall diameter (D) (mm)		Nominal rim diameter (d) (mm)
		Radial	Diagonal	Radial	Diagonal (*)	
11.2-18	10	-	284	-	955	457
11.2-20	10	284	284	995	1 005	508
11.2-24	10	284	284	1 095	1 105	610
11.2-26	10	-	284	-	1 155	660
11.2-28	10	284	284	1 200	1 205	711
11.2-36	10	284	284	1 400	1 410	914
11.2-38	10	284	284	1 455	1 460	965
11.2-42	10	284	-	1 555	-	1 067
11.2-44	10	284	-	1 610	-	1 118
11.2-48	10	284	-	1 710	-	1 219
12.4-16	11	-	315	-	956	406
12.4-20	11	315	-	1 045	-	508
12.4-24	11	315	315	1 145	1 160	610
12.4-26	11	-	315	-	1 210	660
12.4-28	11	315	315	1 250	1 260	711
12.4-30	11	-	315	-	1 310	762
12.4-32	11	315	315	1 350	1 360	813
12.4-36	11	315	315	1 450	1 465	914
12.4-38	11	315	315	1 500	1 515	965
12.4-42	11	-	315	-	1 615	1 067
12.4-46	11	315	-	1 705	-	1 168
12.4-52	11	315	-	1 860	-	1 321
13.6-16	12	-	345	-	1 005	406
13.6-24	12	345	345	1 190	1 210	610
13.6-26	12	345	345	1 260	1 260	660
13.6-28	12	345	345	1 295	1 310	711
13.6-36	12	345	345	1 500	1 515	914
13.6-38	12	345	345	1 550	1 565	965
13.6-46	12	-	345	-	1 768	1 168
13.6-48	12	345	-	1 805	-	1 219
13.9-36	12	-	353	-	1 478	965
14.9/80-24	12	-	368	-	1 215	610
14.9-20	13	-	378	-	1 165	508
14.9-24	13	378	378	1 245	1 265	610
14.9-26	13	378	378	1 295	1 315	660
14.9-28	13	378	378	1 350	1 365	711
14.9-30	13	378	378	1 400	1 415	762

Table 2 (4 of 5)
Drive wheel tyres for agricultural tractors - Normal section sizes

Tyre size designation	Theoretical rim width code (A1)	Nominal section width (S1) (mm)		Overall diameter (D) (mm)		Nominal rim diameter (d) (mm)
		Radial	Diagonal	Radial	Diagonal (*)	
14.9-38	13	378	378	1 600	1 615	965
14.9-46	13	378	-	1 824	-	1 168
15.5-38	14	394	394	1 565	1 570	965
16.9-24	15	429	429	1 320	1 335	610
16.9-26	15	429	429	1 370	1 385	660
16.9-28	15	429	429	1 420	1 435	711
16.9-30	15	429	429	1 475	1 485	762
16.9-34	15	429	429	1 575	1 585	864
16.9-38	15	429	429	1 675	1 690	965
16.9-42	15	429	-	1 775	-	1 067
18.4-16.1	16	-	467	-	1 137	409
18.4-24	16	467	467	1 395	1 400	610
18.4-26	16	467	467	1 440	1 450	660
18.4-28	16	467	467	1 490	1 501	711
18.4-30	16	467	467	1 545	1 550	762
18.4-34	16	467	467	1 645	1 650	864
18.4-38	16	467	467	1 750	1 750	965
18.4-42	16	467	467	1 850	1 850	1 067
18.4-46	16	467	-	1 958	-	1 168

Table 2 (5 of 5)
Drive wheel tyres for agricultural tractors - Normal and low section sizes

Tyre size designation	Theoretical rim width code (A1)	Nominal section width (S1) (mm)		Overall diameter (D) (mm)		Nominal rim diameter (d) (mm)
		Radial	Diagonal	Radial	Diagonal (*)	
20.8-34	18	528	528	1 735	1 735	864
20.8-38	18	528	528	1 835	1 835	965
20.8-42	18	528	528	1 935	1 935	1 067
23.1-26	20	587	587	1 605	1 605	660
23.1-30	20	587	587	1 700	1 705	762
23.1-34	20	587	587	1 800	1 805	864
24.5-32	21	622	622	1 800	1 805	813
Low section height						
7.5L-15	6	-	210	-	745	381
14.9LR-20	13	378	-	1 100	-	508
17.5L-24	15	445	445	1 241	1 265	610
19.5L-24	17	495	495	1 314	1 339	610
21L-24	18	-	533	-	1 402	610
28.1-26	25	-	714	-	1 615	660
28L-26	25	719	714	1 607	1 615	660
30.5L-32	27	775	775	1 820	1 820	813
35.5L-32	31	-	902	-	1 981	813

Notes:

1. The Tyre size designation may be supplemented by a rim contour prefix: ex: VA35.5L-32 instead of 35.5L-32.
 2. Tyres of radial structure are identified by means of the letter "R" in place of " - " (e.g. 23.1R26).
 3. Coefficient for the calculation of the overall width: +8 per cent.
- (*) For Diagonal tyres marked on the tyre sidewall with classification code "R-3" (see paragraph 3.1.14. of this regulation) the overall diameter (D) is to be reduced by 24 mm.

Table 3
Drive wheel tyres for agricultural tractors - Low section series

<i>Tyre size designation</i>	<i>Theoretical rim width code (AI)</i>	<i>Nominal section width (SI) (mm)</i>	<i>Overall diameter (D) (mm)</i>	<i>Nominal rim diameter (d) (mm)</i>
11.2/78-28	10	296	1 180	711
12.4/78-28	11	327	1 240	711
12.4/78-36	11	327	1 440	914
13.6/78-28	12	367	1 285	711
13.6/78-36	12	367	1 490	914
14.9/78-28	13	400	1 345	711
16.9/78-28	15	452	1 410	711
16.9/78-30	15	452	1 460	762
16.9/78-34	15	452	1 560	864
16.9/78-38	15	452	1 665	965
18.4/78-30	16	490	1 525	762
18.4/78-38	16	490	1 730	965

Table 4
Drive wheel tyres for agricultural tractors - Low section series

Tyre size designation (1)	Theoretical rim width code (A1)		Nominal section width (S1) (mm)		Overall diameter (D) (mm)	Nominal rim diameter (d)(mm)
		IF / VF		IF / VF		
300/70R20	9	-	295	-	952	508
320/70R20	10	-	319	-	982	508
320/70R24	10	-	319	-	1 094	610
320/70R28	10	-	319	-	1 189	711
360/70R20	11	-	357	-	1 042	508
360/70R24	11	-	357	-	1 152	610
360/70R28	11	-	357	-	1 251	711
380/70R20	12	13	380	379	1 082	508
380/70R24	12	13	380	379	1 190	610
380/70R28	12	13	380	379	1 293	711
420/70R24	13	14	418	415	1 248	610
420/70R28	13	14	418	415	1 349	711
420/70R30	13	14	418	415	1 398	762
480/70R24	15	16	479	475	1 316	610
480/70R26	15	16	479	475	1 372	660
480/70R28	15	16	479	475	1 421	711
480/70R30	15	16	479	475	1 478	762
480/70R34	15	16	479	475	1 580	864
480/70R38	15	16	479	475	1 681	965
520/70R26	16	18	516	521	1 456	660
520/70R30	16	18	516	521	1 536	762
520/70R34	16	18	516	521	1 640	864
520/70R38	16	18	516	521	1 749	965
580/70R38	18	20	577	580	1 827	965

(1) "Improved flexion tyres" are identified by means of the letters "IF" added in front of the size designation (e.g. IF480/70R38) ; "Very high flexion tyres" are identified by means of the letters "VF" added in front of the size designation (e.g. VF480/70R38) – see paragraphs 2.18.8. and 2.18.9. of this Regulation.

Table 5 (1 of 3)
Agricultural implement tyres - Normal section sizes

Tyre size designation	Theoretical rim width code (A1)	Nominal section width (S1) (mm)	Overall diameter (D) (mm)		Nominal rim diameter (d) (mm)
				(*)	
125 - 15 IMP	3,5	127	590	-	381
140 - 6 IMP	4,5	135	315	-	152
165 - 15 IMP	4,5	167	650	-	381
190-8 IMP	5.50	182	430	-	203
2.50 - 4 IMP	1,75	68	225	-	102
2.75 - 4 IMP	1,75	70	234	-	102
2.50 - 8 IMP	1,5	68	338	-	203
3.00 - 4 IMP	2,5	90	265	-	102
3.00 - 8 IMP	2,5	90	367	-	203
3.00 - 10 IMP	2,5	90	418	-	254
3.25 - 8 IMP	2,10	84	366	-	203
3.25 - 16 IMP	1,85	88	590	-	406
3.50 - 5 IMP	3	95	292	-	127
3.50 - 6 IMP	2,5	100	343	-	152
3.50 - 8 IMP	2,5	100	393	-	203
3.50 - 16 IMP	1,85	92	590	-	406
4.00 - 4 IMP	3	114	313	-	102
4.00 - 5 IMP	3	102	310	-	127
4.00 - 6 IMP	3	114	374	-	152
4.00 - 8 IMP	3	112	418	425	203
4.00 - 9 IMP	3	112	443	460	229
4.0 - 10 IMP	3	114	455	465	254
4.00 - 10 IMP	3	114	465	475	254
4.00 - 12 IMP	3	112	519	536	305
4.00 - 15 IMP	3	112	595	612	381
4.00 - 16 IMP	3	114	618	-	406
4.00 - 18 IMP	3	112	672	688	457
4.00 - 19 IMP	3	114	694	-	483
4.00 - 21 IMP	3	112	765	-	533
4.00/4.50 - 21 IMP	3	110	765	-	533
4.10 - 4 IMP	3,25	102	268	-	102
4.10 - 6 IMP	3,25	102	319	-	152
4.10/3.50-4 IMP	2.10	89	272	-	101
4.50 - 9 IMP	3	124	466	-	229
4.50 - 14 IMP	3	124	593	-	356
4.50 - 16 IMP	3	123	647	-	406
4.50 - 19 IMP	3	124	720	733	483
4.80 - 8 IMP	3,75	121	423	449	203
5.00 - 8 IMP	4	145	467	-	203

Table 5 (2 of 3)
Agricultural implement tyres - Normal section sizes

Tyre size designation	Theoretical rim width code (A1)	Nominal section width (S1) (mm)	Overall diameter (D) (mm)		Nominal rim diameter (d) (mm)
				(*)	
5.00 - 9 IMP	3,5	141	497	-	229
5.0 - 10 IMP	4	145	505	517	254
5.0 - 12 IMP	4	145	566	-	305
5.00 - 12 IMP	4	145	567	580	305
5.00 - 14 IMP	4	145	618	631	356
5.0 - 15 IMP	4	145	642	-	381
5.00 - 15 IMP	3	130	639	655	381
5.00 - 16 IMP	4	145	669	-	406
5.00/5.25 - 21 IMP	3	136	824	-	533
5.50 - 16 IMP	4	150	685	703	406
5.70 - 12 IMP	4,5	146	570	-	305
5.70 - 15 IMP	4,5	146	647	-	381
5.90 - 15 IMP	4	150	665	681	381
6 - 6 IMP	4	145	425	-	152
6.00 - 9 IMP	4,5	169	543	556	229
6 - 12 IMP	5	145	585	-	305
6.0 - 12 IMP	5	155	569	-	305
6.00 - 12 IMP	5	152	579	-	305
6.00 - 16 IMP	4	158	712	729	406
6.00 - 19 IMP	4,5	169	810	-	483
6.00 - 20 IMP	4,5	169	830	-	508
6.40 - 15 IMP	4,5	163	684	-	381
6.5 - 15 IMP	5	163	674	-	381
6.50 - 10 IMP	5	178	597	-	254
6.50 - 16 IMP	4,5	173	735	754	406
6.50 - 20 IMP	5	176	850	-	508
6.70 - 15 IMP	4,5	182	704	720	381
6.90 - 9 IMP	5,5	175	545	-	229
7.00- 12 IMP	5	187	667	685	305
7.00 - 14 IMP	5	170	691	-	356
7.00 - 15 IMP	5,5	200	744	-	381
7.00 - 16 IMP	5,5	200	769	-	406
7.00 - 18 IMP	5,5	200	820	-	457
7.00 - 19 IMP	5,5	200	845	-	483
7.50 - 10 IMP	6	214	634	649	254
7.50 - 14 IMP	5,5	194	686	-	356
7.50 - 15 IMP	6	215	808	-	381
7.50 - 16 IMP	5,5	202	785	801	406
7.50 - 18 IMP	5,5	202	836	852	457

Table 5 (3 of 3)
Agricultural implement tyres - Normal section sizes

Tyre size designation	Theoretical rim width code (A1)	Nominal section width (S1) (mm)	Overall diameter (D) (mm)		Nominal rim diameter (d) (mm)
				(*)	
7.50 – 20 IMP	5.5	202	887	903	508
7.50 – 24 IMP	5.5	202	989	1013	610
7.60 – 15 IMP	5.5	193	734	751	381
8 - 16 IMP	6	211	795	-	406
8.00 - 6 IMP	7	203	452	-	152
8.00 - 12 IMP	5	214	710	-	305
8.00 - 16 IMP	6	206	808	-	406
8.00 - 19 IMP	6	214	888	-	483
8.00 - 20 IMP	6	214	945	-	508
8.25 - 15 IMP	6.5	237	835	-	381
8.25 - 16 IMP	6	229	832	-	406
8.25 - 20 IMP	6	229	934	950	508
9.00 - 10 IMP	6	234	696	-	254
9.00 - 13 IMP	5.5	247	814	-	330
9.00 - 15 IMP	5.5	247	850	-	381
9.00 - 16 IMP	6	234	848	-	406
9.00 - 24 IMP	8	272	1 094	-	610
10.00 - 12 IMP	6,5	262	790	-	305
10.00 - 15 IMP	8	274	853	-	381
10.00 - 16 IMP	8	274	895	-	406
10.50 - 16 IMP	6,5	280	955	-	406
11.00 - 12 IMP	6,5	277	835	-	305
11.00 - 16 IMP	6,5	277	937	-	406
11.0 - 20 IMP	9	285	950	-	508
11.25 - 24 IMP	10	325	1 171	-	610
11.25 - 28 IMP	10	325	1 273	-	711
11.5 - 24 IMP	10	305	1 070	-	610
13.50 – 16.1 IMP	11	353	1021	1043	409
14.0 - 24 IMP	12	370	1 170	-	610
15.0 - 24 IMP	13	400	1 210	-	610
15.0 - 28 IMP	13	400	1 310	-	711
17.0 - 28 IMP	15	455	1 390	-	711
17.0 - 30 IMP	15	455	1 440	-	762
18.5 - 34 IMP	16	490	1 600	-	864
20 - 20 IMP	14	520	1 270	-	508

Notes:

1. The suffix "IMP" may be replaced by the wording "IMPLEMENT" on the tyre sidewall.
2. Tyres of radial structure are identified by means of the letter "R" in place of "-" (e.g. 7.5 L R 15).
3. Overall diameters (D) in column (*) apply to tyres marked with classification code "I-3" – see paragraph 3.1.9.2. of this Regulation.

Table 6 (1 of 3)
Agricultural implement and construction applications tyres - Low section sizes

Tyre size designation	Theoretical rim width code (A1)	Nominal section width (S1) (mm)	Overall diameter (D) (mm)		Nominal rim diameter (d) (mm)
				(*)	
7.5 L - 15 IMP	6	210	745	-	381
8.5L – 14 IMP	6	216	721	735	356
9.5L – 14 IMP	7	241	741	757	356
9.5L – 15 IMP	7	241	767	782	381
11L – 14 IMP	8	279	752	770	356
11L – 15 IMP	8	279	777	796	381
11L – 16 IMP	8	279	803	821	406
12.5L – 15 IMP	10	318	823	845	381
12.5L – 16 IMP	10	318	848	870	406
14L - 16.1 IMP	11	356	940	-	409
16.5L – 16.1 IMP	14	419	1024	1046	409
19 L - 16.1 IMP	16	483	1 087	-	409
21.5 L - 16.1 IMP	18	546	1 130	1 162	409

Table 6 (2 of 3)
Agricultural implement and construction applications tyres - Low section sizes

Tyre size designation	Theoretical rim width code (A1)	Nominal section width (S1) (mm)	Overall diameter (D) (mm)		Nominal rim diameter (d) (mm)
				(*)	
205/50 - 10 IMP	7	211	450	-	254
19.0/45 - 17 IMP	16	491	866	-	432
15.0/55 - 17 IMP	13	391	850	872	432
10.5/65 - 16 IMP	9	274	755	-	406
11.0/60 - 16 IMP	9	281	742	-	406
11.0/65 - 12 IMP	9	281	670	692	305
13.0/65 - 18 IMP	11	336	890	-	457
13.0/70 - 16 IMP	11	337	890	-	406
14.0/65 - 16 IMP	11	353	870	-	406
9.0/70 - 16 IMP	7	226	725	-	406
11.5/70 - 16 IMP	9	290	815	-	406
11.5/70 - 18 IMP	9	290	865	-	457
15.0/70 - 18 IMP	13	391	990	-	457
16.0/70 - 20 IMP	14	418	1075	1097	508
16.5/70 - 22.5 MP	13	417	1 158	-	572
20.0/70 - 508 IMP	16	508	1 220	-	508
8.0/75 - 15 IMP	6.5	199	710	-	381
9.0/75 - 16 IMP	7	226	749	770	406
10.0/75 - 12 IMP	9	264	685	-	305
10.0 - 15.3 IMP	9	258	785	-	389
10.0/75 - 15.3 IMP	9	264	760	780	389
10.0/75 - 16 IMP	9	264	805	-	406
12.0/75 - 18 IMP	9	299	915	937	457
13.0/75 - 16 IMP	11	336	900	-	406
13.5/75 - 430.9 MP	11	345	945	-	431
14.5/75 - 20 IMP	12	372	1 060	-	508
6.5/80 - 12 IMP	5	163	569	588	305
6.5/80 - 15 IMP	5	163	645	663	381
8.50 - 12 IMP	7	235	715	-	305
10.0/80 - 12 IMP	9	264	710	730	305
10 - 18 IMP	9	260	875	-	457
10.5/80 - 18 IMP	9	274	885	907	457
11.5/80 - 15.3 IMP	9	290	845	867	389
11.5/80 - 15.3 IMP	9	290	845	-	389
12.5/80 - 15.3 IMP	9	307	889	-	389
12.5/80 - 18 IMP	9	308	965	987	457
14.5/80 - 18 IMP	12	372	1060	1082	457

Table 6 (3 of 3)
Agricultural implement and construction applications tyres - Low section sizes

Tyre size designation	Theoretical rim width code (A1)	Nominal section width (S1) (mm)	Overall diameter (D) (mm)		Nominal rim diameter (d) (mm)
				(*)	
15.5/80 - 24 IMP	13	394	1240	1262	610
17.0/80 - 508 IMP	13	426	1200	-	508
19.5/80 - 20 IMP	16	499	1300	-	508
21.0/80 - 20 IMP	16	525	1362	-	508
5.5/85 - 9 IMP	4	145	475	-	229
10.5/85 - 15.3 IMP	9	274	792	-	389
13.5/85 - 28 IMP	11	345	1293	-	711
16.5/85 - 24 IMP	13	417	1322	1344	610
16.5/85 - 28 IMP	13	417	1423	1445	711

Notes:

1. The suffix "IMP" may be replaced by the wording "IMPLEMENT". In case of tyres marked with classification code 'I-3' on the tyre sidewall the suffix "IND" may be used in place of "IMP".
2. Tyres of radial structure are identified by means of the letter "R" in place of " - " (e.g. 205/50R10).
3. Overall diameters (D) in column (*) apply to tyres marked with classification code "I-3" – see paragraph 3.1.9.2. of this Regulation.

Table 7 (1 of 4)
Agricultural high flotation tyres

<i>Tyre size designation</i>	<i>Theoretical rim width code (A1)</i>	<i>Nominal section width (S1) (mm)</i>	<i>Overall diameter (D) (mm)</i>	<i>Nominal rim diameter (d) (mm)</i>
9x3.50 - 4	2.75	91	229	101
11x4.00 - 4	3.25	102	280	101
11x4.00 - 5	3	104	272	127
11x7 - 4	6	185	270	101
12x4.00 - 5	3	112	298	127
13x5.00 - 6	3.5	122	320	152
13x6.00 - 6	5	154	330	152
13x6.00 - 8	5	154	330	203
13x6.50 - 6	5	163	330	152
14x4.50 - 6	3.5	113	356	152
14x5.00 - 6	4	127	347	152
14x6.00 - 6	4.5	157	340	152
15x6.00 - 6	4.5	155	366	152
16x4.50 - 9	3	105	405	229
16x5.50 - 8	4.25	142	414	203
16x6.50 - 8	5.375	165	405	203
16x7.50 - 8	5.375	188	411	203
17x8.00 - 8	7	203	438	203
17x8.00 - 12	7	203	432	305
18x6.50 - 8	5	163	457	203
18x7.00 - 8	5.5	178	450	203
18x7.50 - 8	6	191	457	203
18x8.50 - 8	7	214	450	203
18x9.50 - 8	7	235	462	203
19x9.50 - 8	7.5	240	483	203
19x7.50 - 8	5.5	180	480	203
19x8.00 - 10	7	203	483	254
19x10.00 - 8	8.5	254	483	203
20x8.00 - 8	6.5	204	508	203
20x8.00 - 10	7	203	500	254
20x9.00 - 8	7	227	508	203
20x10.00 - 8	8	254	508	203
20x10.00 - 10	8.5	254	508	254
20.5x8.00 - 10	6	208	526	254
21x7.00 - 10	5.5	177	533	254
21x8.00 - 10	7	203	525	254
21x11.00 - 8	8.5	282	518	203
21x11.00 - 10	9	279	525	254
22x8.00 - 10	6	196	556	254
22x8.50 - 12	7	216	551	305
22x10.00 - 8	7	244	572	203
22x10.00 - 10	8.5	254	559	254

Table 7 (2 of 4)
Agricultural high flotation tyres

<i>Tyre size designation</i>	<i>Theoretical rim width code (A1)</i>	<i>Nominal section width (S1) (mm)</i>	<i>Overall diameter (D) (mm)</i>	<i>Nominal rim diameter (d) (mm)</i>
22x11.00 - 8	8.5	284	546	203
22x11.00 - 10	8.5	254	559	254
23x8.50 - 12	7	214	575	305
23x9.00 - 12	7.5	229	575	305
23x9.50 - 12	7	235	577	305
23x10.50 - 12	8.5	264	579	305
24x8.00 - 12	6.5	204	610	305
24x8.50 - 12	7	213	602	305
24x8.50 - 14	7	213	602	356
24x10.00 - 12	8	254	610	305
24x11.00 - 10	8.5	254	607	254
24x12.00-12	9.5	304	610	305
24x13.00 - 12	10.5	325	592	305
25x7.50 - 15	5.5	191	640	381
25x8.00 - 12	6.5	203	635	305
25x8.50 - 14	7	213	645	356
25x10.00 - 12	8	254	635	305
25x10.50 - 15	8	267	640	381
25x11.00 - 12	9	279	635	305
25x12.00 - 9	10	305	635	229
25x12.50 - 15	10	310	640	381
26x8.00 - 12	6.5	204	660	305
26x8.00 - 14	6.5	204	660	356
26x10.00 - 12	10	310	660	305
26x12.00 - 12	10	310	660	305
26x14.00 - 12	12	356	660	305
27x8.50 - 15	7	214	680	381
27x9.50 - 15	7	229	686	381
27x10.00 - 14	8	254	686	356
27x10.50 - 15	8.5	259	691	381
27x10 - 15.3	9	261	685	389
27x12.00 - 14	9.5	304	686	356
28x9.00 - 14	7	227	711	356
28x9.00 - 15	7	234	710	381
28x10.00 - 12	8	254	711	305
28x10.00 - 15	8	254	711	381
28x11.00 - 14	9	281	711	356
28x11.00 - 15	9	281	711	381

Table 7 (3 of 4)
Agricultural high flotation tyres

<i>Tyre size designation</i>	<i>Theoretical rim width code (A1)</i>	<i>Nominal section width (S1) (mm)</i>	<i>Overall diameter (D) (mm)</i>	<i>Nominal rim diameter (d) (mm)</i>
28x12.00 - 12	9.5	304	711	305
28x13 - 15	11.5	330	711	381
29x9.00 - 14	7	227	737	356
29x9.00 - 15	7	227	737	381
29x9.00 - 16	7	227	737	406
29x9.50 - 15	7.5	240	737	381
29x11.00 - 14	9	281	737	356
29x11.00 - 16	9	281	737	406
29x12.00 - 15	10	310	742	381
29x12.50 - 15	10	310	742	381
29x13.50 - 15	10	351	742	381
30x9.00 - 14	7	227	762	356
30x10.00 - 14	8	254	762	356
30x10.00 - 15	8	254	762	381
30x11.00 - 14	9	281	762	356
31x10.00 - 17	8	254	787	432
31x11.50 - 15	8	301	793	381
31x12.50 - 15	10	310	792	381
31x13.50 - 15	10	351	782	381
31x13.5 - 15	10	351	782	381
31x15.50 - 15	13	391	792	381
31x15.5 - 15	13	391	792	381
32x10.00 - 16	8	254	813	406
32x10.00 - 18	8	254	813	457
33x12.50 - 15	10	310	843	381
33x15.50 - 15	13	391	843	381
35x16 - 17.5	10.5	406	914	445
36x13.50 - 15	10	351	909	381
38x14.00 - 20	11	356	991	508
38x18.00 - 20	14	457	991	508
38x20.00 - 16.1	16	488	991	409
40x19 - 19.5	15	495	1003	495
41x14.00 - 20	11	356	1 067	508
42x25.00 - 20	20.5	622	1 080	508
43x13.50 - 22	10	360	1 102	559
44x18.00 - 20	14	457	1 143	508
44x41.00 - 20	36	991	1 143	508

Table 7 (4 of 4)
Agricultural high flotation tyres

<i>Tyre size designation</i>	<i>Theoretical rim width code (A1)</i>	<i>Nominal section width (S1) (mm)</i>	<i>Overall diameter (D) (mm)</i>	<i>Nominal rim diameter (d) (mm)</i>
48x20.00 - 24	15	457	1 245	610
48x25.00 - 20	20.5	635	1 245	508
48x31.00 - 20	26	775	1 245	508
54x31.00 - 26	26	775	1 397	660
54x37.00 - 25	32	940	1397	635
57x31.00 - 26	26	775	1473	660
66x43.00 - 25	36	1 054	1 702	635
66x43.00 - 26	36	1 054	1 702	660
66x44.00 - 25	36	1 118	1 702	635
67x34.00 - 25	30	864	1 727	635
67x34.00 - 26	30	864	1 727	660
67x34.00 - 30	30	864	1 727	762
68x50.00 - 32	44	1 270	1 753	813
73x44.00 - 32	36	1 118	1 880	813
VA73x44.00 - 32	36	1 118	1 880	813
DH73x44.00 - 32	36	1 118	1 880	813
DH73x50.00-32	44	1 270	1 880	813
73x50.00-32	44	1 270	1 880	813
76x50.00-32	44	1 270	1 956	813

Notes:

1. These Tyres may be classified in categories of use "Tractor Drive Wheels", "Implement" or, in the case of tyres with nominal rim diameters of 635 mm and above, also "Forestry Machines".
2. Implement Tyres are identified either by suffix "IMP" placed after the Tyre size designation (e.g. 11x4.00 - 4 IMP) or by the word "IMPLEMENT" marked on the Tyre sidewalls.
3. Tyres of radial structure are identified by means of the letter "R" in place of " - " (e.g. 11x4.00 R 4). The Tyre size designation may be supplemented by a rim contour prefix (eg: VA73x44.00-32 instead of 73x44.00-32)
4. Coefficient "b" for the calculation of the Overall diameter Dmax:
 - (a) 1.12 for tyres with Nominal rim Diameter (d) less than 380 mm;
 - (b) 1.10 for tyres with Nominal rim Diameter (d) 381 mm and above.
5. In case of Tyre Size designations not included in this table (e.g. 27x10.00 – 16):
 - (a) The first number (e.g. 27) represents the overall diameter (D) expressed by code;
 - i. For tyres with rim diameters of 508 mm and above, add 1 before converting to mm
 - (b) The second number (e.g. 10.00) represents the nominal section width (S1) expressed by code, and
 - (c) The third number (e.g. 16) represents the nominal rim diameter (d) expressed by code – see point 2.19.

To convert dimensions expressed in code to mm multiply by 25.4 and round to the nearest mm. The theoretical rim width code (A1) is taken to equal to the nominal section width (S1) expressed by code multiplied by the factor 0.8 rounded to the nearest 0.5 step.

Table 8
Log-Skidder Tyres for Forestry Machines – Code-Designated Sizes

<i>Tyre size designation</i>	<i>Theoretical rim width code (A1)</i>	<i>Nominal section width (S1) (mm)</i>	<i>Overall diameter (D) (mm)</i>	<i>Nominal rim diameter (d) (mm)</i>
16.9-30 LS	15	429	1511	762
18.4-26 LS	16	467	1476	660
18.4-30 LS	16	467	1577	762
18.4-34 LS	16	467	1679	864
23.1-26 LS	20	587	1632	660
24.5-32 LS	21	622	1831	813
28L-26 LS	25	714	1644	660
30.5L-32 LS	27	775	1847	813
35.5L-32 LS	31	902	2011	813

Notes:

1. Log-Skidder Tyres are identified by suffix "LS-1", "LS-2", "LS-3", or "LS-4" placed after the size designation (e.g. 30.5L-32 LS-2).
2. Tyres of radial structure are identified by means of the letter "R" in place of "-" (e.g. 30.5LR32 LS).
3. The Tyre size designation may be supplemented by a rim contour prefix (e.g.: DH35.5L-32 LS instead of 35.5L-32 LS).

Table 9
Tyres for construction applications (industrial tractors)

Tyre size designation	Theoretical rim width code (A1)	Nominal section width (S1) (mm)		Overall diameter (D) (mm)		Nominal rim diameter (d) (mm)
		Radial	Diagonal	Radial	Diagonal	
10.5/80-18	9	274	274	885	885	457
11L-16 IND	8	290	-	850	-	406
12.5/80-18	9	308	308	965	965	457
12.5-18	11	325	325	990	990	457
12.5-20	11	325	325	1040	1040	508
14.5-20	11	355	355	1095	1095	508
14.9-24	13	378	378	1 245	1 240	610
14.9-28	13	378	378	1 350	1 345	711
16.9-24	15	429	429	1 320	1 310	610
16.9-28	15	429	429	1 420	1 410	711
16.9-34	15	-	429	-	1 560	864
17.5L-24	15	445	445	1 250	1 241	610
18.4-24	16	467	467	1 395	1 375	610
18.4-26	16	-	467	-	1 425	660
18.4-28	16	467	467	1 490	1 477	711
18.4-30	16	-	467	-	1 525	762
19.5L-24	17	495	495	1 320	1 314	610
21L-24	18	533	533	1 395	1 378	610
21L-28	18	-	533	-	1 479	711
23.1-26	20	-	587	-	1 580	660

Notes:

1. These tyres are identified either by suffix "IND", placed after the Tyre size designation (e.g. 14.9-24 IND), or by the following marking added to the tyre sidewalls: "R-4".
2. Tyres of radial structure are identified by means of the letter "R" in place of " - " (e.g. 14.9 R 24).
3. Coefficient for the calculation of the overall width of radial tyres: + 8 %.

Table 10
Tyres for construction applications (skid-steers / mini-loaders)

<i>Tyre size designation</i>	<i>Theoretical rim width code (A1)</i>	<i>Nominal section width (S1) (mm)</i>	<i>Overall diameter (D) (mm)</i>	<i>Nominal rim diameter (d) (mm)</i>
7.00-15	5.50	201	762	381
8.25-15	6.00	231	848	381
5.70-12	4.50	146	570	305
5.70-15	4.50	146	647	381
23x8.50-12	7.00	213	574	305
23x8.50-14	7.00	218	584	356
23x10.50-12	8.50	264	579	305
25x8.50-14	7.00	218	635	356
26x12.00-12	10.50	307	648	305
9.00-20	7.00	259	1038	508
10.00-20	7.50	278	1075	508
11.00-20	8.00	293	1104	508
10-16.5	8.25	264	773	419
12-16.5	9.75	307	831	419
14-17.5	10.50	349	921	445
15-19.5	11.75	389	1019	495
15-22.5	11.75	389	1095	572
18-19.5	14	457	1096	495
18-22.5	14	457	1172	572

Notes:

1. Tyres of radial structure are identified by means of the letter "R" in place of "-" (e.g. 12R16.5)
2. Suffixes "IND" or "NHS" or "SS" identify tyres for skid-steers / mini-loaders (see paragraph 2.18.12.1)

Annex 6

Test method for measuring tyre dimensions

1. The tyre shall be mounted on the measuring rim specified by the manufacturer and is inflated to a pressure specified by the manufacturer.
- 1.1. To seat the beads do not exceed the inflation pressure marked on the tyre sidewalls.
- 1.2. Having properly seated tyre beads on the rim, adjust the pressure to the value specified for tyre measurements.
2. The tyre fitted on its rim is conditioned to the ambient temperature of the laboratory for at least 24 hours.
3. The pressure is readjusted to the value specified in paragraph 1.
4. The overall width is measured by calliper at six equally-paced points, account being taken of the thickness of the protective ribs or bands. The highest measurement so obtained is taken as the overall width.
5. The outer diameter is determined by measuring the maximum circumference and dividing the figure so obtained by π (3,1416).

Annex 7

Variation of load capacity with speed

(See paragraphs 2.33. and 2.34. of this Regulation)

Part A: Drive wheel tyres for agricultural tractors

Applicable to tyres classified with categories of use: "Tractor drive wheel" (see paragraph 2.23. of this Regulation)

Variation of load carrying capacity (per cent)

Speed (km/h)	Speed category symbol						(2)	(3)
	A2	A6 (+)	A8 (+)	D (+)	A8 (1)	D (1)		
10	0	+40	+50	+50	0	0	+ 58	+ 56
15	-6	+30	+34	+34	0	0	+ 32	+ 44
20	-11	+20	+23	+23	0	0	+ 26	+ 33
25	-16	+7	+11	+18,5	0	0	+ 19	+ 22
30	-20	0	+7	+15	0	0	+ 12	+ 11
35	-24	-5	+3	+12	0	0	+ 10	+ 6
40	-27	-10	0	+9,5	0	0	+ 6	0
45	-	-	-4	+7	-4	0	+ 2	-
50	-	-	-9	+5	-9	0	0	-
55	-	-	-	+3	-	0	-	-
60	-	-	-	+1,5	-	0	-	-
65	-	-	-	0	-	0	-	-
70	-	-	-	-9	-	-9	-	-

The above load/speed variations apply when the tyre is not subjected to sustained high torque service.

- (+) For field applications with sustained high torque service the values shown in the line 30 km/h apply.
- (1) These load/speed variations apply to IF and VF Tyres.
- (2) These percentages apply only in case of tyres listed in Annex 5, Table 7, with nominal rim diameter (d) 381 mm and above, marked with speed symbol "B"
- (3) These percentages apply only in case of diagonal tyres listed in Annex 5, Table 2 'Drive wheel tyres for agricultural tractors - Normal section sizes' with nominal section width (S1) 211 mm and above (i.e. section width code 8.3 and above) marked with speed symbol "A8".

Part B: Steering wheel tyres for agricultural and forestry tractors

Applicable to tyres classified with category of use "Tractor steering wheels" and marked "Front" or "F-1" or "F-2" or "F-3" (see paragraph 2.24. of this Regulation)

Variation of load carrying capacity (per cent) (See paragraph 2.33. of this Regulation)

Speed (km/h)	Speed category symbol	
	A6	A8
10	+50	+67
15	+43	+50
20	+35	+39
25	+15	+28
30	0	+11
35	-10	+4
40	-20	0
45	-	-7

Part C: Implement tyres

Applicable to tyres classified with categories of use: "Implement" and marked "IMP" or "IMPLEMENT" (see paragraph 2.25. of this Regulation)

Variation of load carrying capacity (per cent) (see paragraphs 2.33. and 2.34. of this Regulation)

Speed (km/h)	Speed category symbol				(1)
	A4	A6(*)	A8(*)	D	
10	+ 20	+ 29	+ 40	+ 80	+ 58
15	+ 12	+ 21	+ 33	+ 73	+ 32
20	0	+ 14	+ 26	+ 65	+ 26
25	- 2	+ 7	+ 19	+ 58	+ 19
30	- 5	0	+ 12	+ 51	+ 12
35	-	- 5	+ 5	+ 44	+ 10
40	-	- 10	0	+ 36	+ 6
45	-	-	- 5	+ 29	+ 2
50	-	-	- 10	+ 21	0
55	-	-	-	+ 14	-
60	-	-	-	+ 7	-
65	-	-	-	0	-
70	-	-	-	- 9	-

The above load/speed variations apply when the tyre is not subjected to sustained high torque service.

- (*) For tyres with nominal rim diameter code 24 and above, excluding codes 24.5, 26.5, 28.5 and 30.5, Annex 7, Part A applies.
- (1) These percentages apply only in case of tyres listed in Annex 5, Table 7, with nominal rim diameter (d) 381 mm and above, marked with speed symbol "B".

Part D: Tyres for forestry machines

Applicable to tyres classified with categories of use: "Forestry machines" (see paragraph 2.44. of this Regulation)

Variation of load carrying capacity (per cent) for tyres marked with speed category symbols A6 and A8 (see paragraphs 2.33. and 2.34. of this Regulation)

<i>Service condition</i>	<i>Speed (Km/h)</i>	<i>A6</i>	<i>A8</i>
Road service	20	+15 %	+23 %
	30	0	+7 %
	40	-10 %	0

Part E: Tyres for construction applications (industrial tractors or skid-steers / mini-loaders)

Applicable to tyres classified with categories of use: "Construction Applications" (see paragraph 2.45.) and marked "IND" or "R-4" or "SS" or "NHS" (see paragraph 2.25. and 2.18.12.1 of this Regulation)

Variation of load carrying capacity (per cent) (see paragraph 2.33. of this Regulation)

<i>Speed (km/h)</i>	<i>Speed Category Symbol</i>		
	<i>A2</i>	<i>A8</i>	
		<i>Constant load</i>	<i>Cyclic applications (+)</i>
5	+ 11	+ 45	+ 67 (1)
10	0	+ 25	+ 50 (2)
15	- 21	+ 13	+ 34
20	- 24	+ 9	+ 23
25	- 28	+ 6	+ 11
30	- 32	+ 4	+ 7
35	- 33	+ 2	+ 3
40	- 34	0	0
45	- 35	- 4	- 4
50	- 37	- 9	- 9

(+) Cyclic means applications where tyres are used one way laden and return unladen (e.g loaders).

(1) One way distance 150 m, fully loaded.

(2) One way distance 600 m, fully loaded.

Note: speed category symbol A2 applies to tyres marked with suffix "SS" or "NHS"

Annex 8

Test procedure to assess tyre resistance to bursting

1. Preparing the tyre
 - 1.1. Mount a new tyre on the test equipment. Wheels used for the test shall be suitable to withstand, with no deformation, the highest value of pressure achievable during the test.
 - 1.2. Carefully centre the tyre beads on the retention device and adjust the outer distance of the tyre beads to a value corresponding to the width of the rim specified by the manufacturer pursuant to paragraph 4.1.10. of this Regulation.
 - 1.3. Fill the tyre with water taking care that all the air inside the tyre is expelled.
2. Test procedure
 - 2.1. Activate the apparatus and increase the pressure of the water inside the tyre in order to reach progressively the limit given by two and half times the pressure specified by the tyre manufacturer pursuant to paragraph 4.1.12. of this Regulation;
 - 2.1.1. In no case, however, the limit value shall be lower than 6 bar (600 kPa) or higher than 10 bar (1 000 kPa).
 - 2.2. Maintain constant the value of the pressure for at least 10 minutes.
 - 2.3. Decrease, progressively, the pressure of the water to zero and drain the tyre.
 - 2.4. Whilst the pressure of the water inside the tyre is higher than the ambient pressure, nobody shall stand inside the test room that shall be safely locked.
3. Equivalent test methods

If a method other than that described above is used, its equivalence must be demonstrated.

Annex 9

Load/speed test procedure

1. Scope and range of application
 - 1.1. This test procedure is applicable for new tyres marked with speed category symbol "D".
 - 1.2. It serves the purpose to assess the suitability of the tyre for the claimed performances.
2. Preparing the tyre
 - 2.1. Mount new tyres on the test rim specified by the manufacturer pursuant to paragraph 4.1.10. of this Regulation.
 - 2.1.1. To seat the beads do not exceed the maximum pressure marked on the tyre sidewalls.
 - 2.2. Use a new inner tube when testing tyres with inner tubes (i.e. tyres not bearing the marking "Tubeless").
 - 2.3. With the tyre beads properly seated on the rim, inflate the tyre to the pressure corresponding to the test pressure specified by the tyre manufacturer for the type of test programme, pursuant to paragraph 4.1.15. of this Regulation.
 - 2.4. Condition the tyre and wheel assembly at test room temperature for not less than three hours.
 - 2.5. Readjust the tyre pressure to that specified in paragraph 2.3. above.
 - 2.6. On request of the tyre manufacturer proceed with the test programme as specified in either of the following paragraphs:
 - Test procedure in a laboratory on a test drum (paragraph 3. below), or
 - Test procedure on a road using a trailer (paragraph 4.).
3. Test procedure on a test drum
 - 3.1. Mount the tyre and wheel assembly on the test axle and press it against the outer face of a smooth power-driven test drum of at least 1,700 mm \pm 1 per cent in diameter having a surface at least as wide as the tyre tread.
 - 3.1.1. Drum widths narrower than the tyre tread pattern may be used if the tyre manufacturer agrees.
 - 3.2. Test drum speed: 20 km/h.
 - 3.3. Apply to test axle a series of masses in accordance with the load/speed test programme shown in paragraph 3.4. below, with reference to the test load which equates:
 - 3.3.1. The mass corresponding to load index marked on the tyre in case of tyres marked with speed symbol D.

3.4. Load/speed test programme:

<i>Tyre speed category symbol</i>	<i>Test step</i>	<i>Percentage of the test load</i>	<i>Duration (hours)</i>
D	1	66 per cent	7
	2	84 per cent	16
	3	101 per cent	24

3.4.1. In case of a test drum diameter larger than 1,700 mm ± 1 per cent, the above "percentage of test load" shall be increased as follows:

$$F_1 = K \cdot F_2$$

Where:

$$K = \sqrt{\frac{(R_1/R_2) \cdot (R_2 + r_T)}{(R_1 + r_T)}}$$

R_1 is the diameter of test drum, in millimeter

R_2 is the diameter of the reference test drum of 1,700 mm

r_T is the tyre outer diameter (see paragraph 6.2. of this Regulation), in millimeter

F_1 is the percentage of load to be applied for the test drum

F_2 is the percentage of load, as per above table, to be applied for reference test drum of 1,700 mm

Example:

$K = 1$ for a test drum diameter of 1,700 mm;

In case of a test drum diameter of 3,000 mm and a tyre diameter of 1500 mm:

$$K = \sqrt{\frac{(3000/1700) \cdot (1700 + 1500)}{(3000 + 1500)}} = 1.12$$

3.5. The tyre pressure must not be corrected throughout the test and the test load must be kept constant throughout each of the three test steps.

3.6. During the test the temperature in the test room must be maintained at between 20 °C and 30 °C or at another temperature if the manufacturer so agrees.

3.7. The load/speed test programme must be carried out without interruption.

4. Test procedure on a trailer

4.1. Mount two new tyres of the same type on a trailer

4.2. Apply on the trailer a mass in order that each tyre be equally loaded with a test load corresponding to the load carrying capacity allowed for that tyre type at 15 km/h (see load variations in Annex 7).

4.3. Run the trailer at a constant speed of 15 km/h ± 1 km/h for 48 hours.

- 4.3.1. Temporary interruptions are allowed, but they must be compensated by an additional run-in of 5 min for every 20 minutes of interruption.
- 4.4. The tyre pressure must not be corrected and the test load must be kept constant throughout the test.
- 4.5. During the test the ambient temperature shall be between 5 °C and 30 °C or at another temperature if the manufacturer so agrees.
- 5. Equivalent test methods
If a method other than those described above is used, its equivalence must be demonstrated.

Annex 10

Tyre classification code

(Optional marking)

<i>Classification code</i>	<i>Nomenclature</i>
F-1	Agricultural tractor steering wheel tyres: single rib tread
F-2	Agricultural tractor steering wheel tyres: multiple rib tread
F-3	Steering wheel tyres: industrial service (construction application)
G-1	Garden tractor tyres (implement tyres): traction service
G-2	Garden tractor tyres (implement tyres): flotation traction service
G-3	Garden tractor tyres (implement tyres): maximum flotation service
HF-1	High-flotation tyres: shallow tread
HF-2	High-flotation tyres: regular tread
HF-3	High-flotation tyres: deep tread
HF-4	High-flotation tyres: extra deep tread
I-1	Agricultural implement tyres: multi-rib tread
I-2	Agricultural implement tyres: moderate traction service
I-3	Agricultural implement tyres: traction tread
I-4	Agricultural implement tyres: plough tail wheel service
I-5	Agricultural implement tyres: steering service
I-6	Agricultural implement tyres: Smooth tread
LS-1	Logging and forestry service tyres: regular tread
LS-2	Logging and forestry service tyres: intermediate tread
LS-3	Logging and forestry service tyres: deep tread
LS-4	Logging and forestry service tyres: shallow tread
R-1	Agricultural tractor drive wheel tyres: regular tread
R-2	Agricultural tractor drive wheel tyres: cane and rice service (deep tread)
R-3	Agricultural tractor drive wheel tyres: flotation service (shallow tread)
R-4	Drive wheel tyres: industrial service (construction application)

Annex 11

Example of the pictogram to be marked on both tyre sidewalls of the tyres to explicit the maximum inflation pressure not to be exceeded for bead seating during tyre mounting

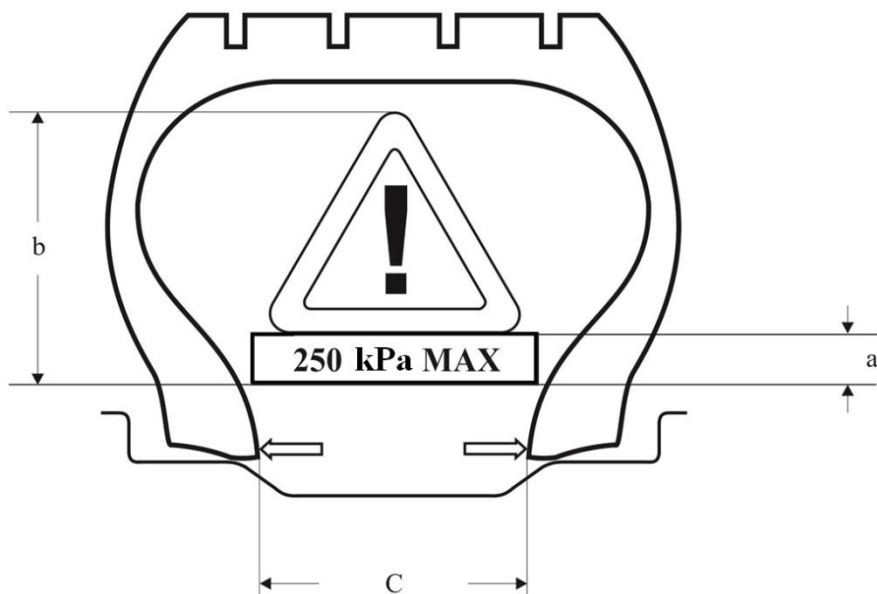

- a = 2 mm min (height of lettering)
- b = 12 mm min for tyre section height \leq 120 mm
18 mm min for tyre section height $>$ 120 mm
- c = 14 mm min (width of lettering)

The pictogram must be placed on both sidewalls.

The value of inflation pressure (250 kPa in the example) must be the same as specified by the tyre manufacturer in paragraph 4.1.14. of this Regulation.