



Economic and Social Council

Distr.: General
6 August 2015

Original: English

Economic Commission for Europe

Inland Transport Committee

World Forum for Harmonization of Vehicle Regulations

Working Party on Lighting and Light Signalling

Seventy-fourth session

Geneva, 20–23 October 2015

Item 7 (e) of the provisional agenda

Other Regulations - Regulation No. 86 (Installation of lighting and light-signalling devices for agricultural tractors)

Proposal for the 01 series of amendments to Regulation No. 86 (Installation of lighting and light-signalling devices for agricultural vehicles)

Submitted by the Chairs of the Informal Working Group on Agricultural Vehicles Lighting Installation*

The text reproduced below was prepared by the GRE Informal Group "Agricultural Vehicles Lighting Installation" (AVLI) to update and revise Regulation No. 86. The modifications to the current text of the UN Regulation are marked in bold for new or strikethrough for deleted characters.

* In accordance with the programme of work of the Inland Transport Committee for 2012–2016 (ECE/TRANS/224, para. 94 and ECE/TRANS/2012/12, programme activity 02.4), the World Forum will develop, harmonize and update Regulations in order to enhance the performance of vehicles. The present document is submitted in conformity with that mandate.

I. Proposal

Contents, amend to read:

Regulation	Page ¹
1. Scope
2. Definitions.....	...
3. Application for approval
4. Approval
5. General specifications
6. Individual specifications
7. Modification and extension of approval of the vehicle type or of the installation of its lighting and light-signalling devices.....	...
8. Conformity of production.....	...
9. Penalties for non-conformity of production
10. Production definitely discontinued.....	...
11. Names and addresses of technical services responsible for conducting approval tests, and of administrative departments
12. Transitional provisions
 Annexes	
1. Communication
2. Examples of arrangements of approval marks
3. The relevant parts of Annex 3 of Regulation No. 48 apply
4. Visibility of lamps.....	...
5. Direction-indicator lamps – Geometric visibility.....	...
6. Signalling panels and signalling foils

¹ Page numbers will be added at a later stage.

Paragraph 1., amend to read:

"1. Scope

This Regulation applies to vehicles of category T, **R and S²**, with regard to the installation of lighting and light-signalling devices."

Paragraph 2.8.2., delete:

~~"2.8.2. "Textured outer lens" or "Textured outer lens area" means all or part of an outer lens, designed to modify or influence the propagation of light from the light source(s), such that the light rays are significantly diverted from their original direction."~~

Insert a new paragraph 2.20.3., to read:

"2.20.3. "Signalling panel or signalling foil" means a device used to indicate to other road users the presence of a wide or long vehicle when viewed from the front, rear or side."

Paragraph 4.2., amend to read:

"4.2. An approval number shall be assigned to each type approved. Its first two digits (at present 00 for the Regulation in its original form **01, corresponding to the 01 series of amendments**) shall indicate the series of amendments incorporating the most recent major technical amendments to the Regulation. The same Contracting Party may not assign the same number to another vehicle type or to the same vehicle type submitted with equipment not specified in the list referred to in paragraph 3.2.2. above subject to paragraph 7. of this Regulation."

Paragraph 5.1.1., amend to read:

"5.1.1. Vehicles must be fitted with the permanently connected socket outlet specified in ISO standard 1724-(1980) ~~(Electrical connections for vehicles with 6 or 12 volt electrical systems applying more specifically to private motor cars and lightweight trailers or caravans):~~**2003 (Road vehicles - Connectors for the electrical connection of towing and towed vehicles - 7 pole connector type 12 N (normal) for vehicles with 12 V nominal supply voltage)**, or ISO 1185-(1975) ~~(Electrical connections between towing and towed vehicles having 24 volt electrical systems used for international commercial transport purposes):~~**2003 (Road vehicles -- Connectors for the electrical connection of towing and towed vehicles -- 7-pole connector type 24 N (normal) for vehicles with 24 V nominal supply voltage) or both when they have a connection for attaching trailed vehicles or mounted machines."**

Paragraph 5.9.1., amend to read:

"5.9.1. Direction-indicator lamps and the vehicle-hazard warning signal shall be flashing lamps. **Amber side-marker lamps may be flashing lamps."**

² As defined in the Consolidated Resolution on the Construction of Vehicles (R.E.3.), document ECE/TRANS/WP.29/XXX
www.unece.org/trans/main/wp29/wp29wgs/wp29gen/wp29resolutions.html

Paragraph 5.14., amend to read:

- "5.14. The colours of the light emitted by the lamps³ are the following:
- Main-beam headlamp: White
 - Dipped-beam headlamp: White
 - Front fog lamp: White or selective yellow
 - Reversing lamp: White
 - Direction-indicator lamp: Amber
 - Hazard warning signal: Amber
 - Stop lamp: Red
 - Rear registration plate illuminating device: White
 - Front position lamp: White
 - Rear position lamp: Red
 - Rear fog lamp: Red
 - Parking lamp: White in front, red at the rear, amber if reciprocally incorporated in the side direction indicator lamps or in the side-marker lamps.
 - Side-marker lamp: Amber; however the rearmost side-marker lamp can be red if it is grouped or combined or reciprocally incorporated with the rear position lamp, the rear end-outline marker lamp, the rear fog lamp, the stop lamp or is grouped or has part of the light emitting surface in common with the rear retro-reflector.
 - End-outline marker lamp: White in front, red at the rear.
 - Daytime running lamp: White
 - Rear retro-reflector, triangular: Red**
 - Rear retro-reflector, non-triangular: Red
 - Front retro-reflector, non-triangular: **White or colourless**
 - Side retro-reflector, non- triangular: Amber; however the rearmost side retro-reflector can be red if it is grouped or has part of the light emitting surface in common with the rear position lamp, the rear end outline marker lamp, the rear fog lamp, the stop-lamp, the red rearmost side-marker lamp or the rear retro-reflector, non- triangular.
 - Cornering lamp: White
 - Conspicuity marking: White or yellow to the side; Red or yellow to the rear.
 - Exterior courtesy lamp: White
 - Manoeuvring lamp: White
 - Signalling panel or signalling foil: White and red"**

³ Measurement of the chromaticity coordinates of the light emitted by the lamps is not part of this regulation.

Paragraph 6.1.1., amend to read:

"6.1.1. Presence: **Mandatory for vehicles of category T having a maximum design speed of more than 40 km/h.**
Optional on other vehicles of category T.
Prohibited on vehicles of categories R and S."

Paragraph 6.2.1., amend to read:

"6.2.1. Presence: **Mandatory on vehicles of category T. Prohibited on vehicles of categories R and S.**"

Paragraph 6.3.1., amend to read:

"6.3.1. Presence: **Optional on vehicles of category T. Prohibited on vehicles of categories R and S.**"

Paragraph 6.5.1., amend to read:

"6.5.1. Presence: **Mandatory.** Types of indicators fall into categories (1, 1a, 1b, 2a, 2b, ~~and 5 and 6~~) the assembly of which on one tractor constitutes an arrangement (A to D).
Arrangement A **and D** shall be allowed only on ~~tractors~~ **vehicles of category T** whose overall length does not exceed 4,600 mm and in the case of which the distance between the outer edges of the illuminating surfaces is not more than 1.60 m.
Arrangements B, **and C** ~~and D~~ shall apply to all ~~tractors~~ **vehicles of category T.**
For vehicles of categories R and S category 2a lamps shall be used.
Additional direction-indicator lamps optional."

Paragraph 6.5.3.1., amend to read:

"**6.5.3.1. For vehicles of category T:** "A" Two front direction-indicator lamps (category 1, 1a or 1b),
Two rear direction-indicator lamps (category 2a).
These lamps may be independent, grouped or combined.
"B" Two front direction-indicator lamps (category 1, 1a or 1b),
Two repeating side direction-indicator lamps (category 5 **or 6**),

Two rear direction-indicator lamps (category 2a).

The front and repeating side lamps may be independent, grouped, or combined.

"C" Two front direction-indicator lamps (category 1, 1a or 1b),

Two rear direction-indicator lamps (category 2a),

Two repeating side indicator lamps (category 5 **or 6**)

"D" Two front direction-indicator lamps (category 1, 1a or 1b),

Two rear direction-indicator lamps (category 2a)."

Insert a new paragraph 6.5.3.2., to read:

"6.5.3.2. For vehicles of categories R and S: Two rear direction-indicator lamps (category 2a) with angles of geometric visibility according to Arrangement B, C or D."

Paragraph 6.5.4.3., amend to read:

"6.5.4.3. Length:

The distance between the center of reference of illuminating surface of the category 1 indicator (arrangement "B"), category 5 **or 6** indicator (arrangement "B" and "C") and the transverse plane which marks the forward boundary of the tractor's overall length normally shall not exceed 1,800 mm. If the structure of the tractor makes it impossible to keep to the minimum angles of visibility, this distance may be increased to 2,600 mm."

Paragraph 6.7.5., amend to read:

"6.7.5. Geometric visibility:

Horizontal angle: 45° outwards and inwards. **The horizontal inward angle may be reduced to 30° if the shape of the bodywork makes it impossible to reach 45°.**

Vertical angle: 15° above and below the horizontal.

~~15° above and below the horizontal.~~ The vertical angle below the horizontal may be reduced to 10° or 5° where the lamp has its H plane at or below 1,900 mm respectively 950 mm from the ground."

Paragraph 6.8.1., amend to read:

- "6.8.1. Presence: **Mandatory on all vehicles of category T.**
- Mandatory on all vehicles of categories R and S exceeding 1,600 mm in width, [with the exception of those vehicles where the shape, structure, design or operational requirements of the vehicle make it impossible to install such lamps.]**
- Optional on other vehicles of categories R and S.**
- The front position lamps may be omitted if end-outline marker lamps are installed and meet all the installation requirements for front position lamps."**

Paragraph 6.9.5., amend to read:

- "6.9.5. Geometric visibility: Horizontal angle: For the two rear position lamps: either 45° inwards and 80° outwards, or 80° inwards and 45° outwards. **The horizontal inward angle may be reduced to 30° if the shape of the bodywork makes it impossible to reach 45°.**
- Vertical angle: 15° above and below the horizontal. The angle below the horizontal may be reduced to 10° if the height of the lamp above the ground is less than 1,900 mm, and to 5° if this height is less than 750 mm.
- 6.9.5.1. If it is impossible to observe the above position and visibility requirements, four rear position lamps may be fitted in accordance with the following installation specifications:
- 6.9.5.1.1. Two rear position lamps must keep within the maximum height of 2,500 mm above the ground.
- A distance of at least 300 mm between the interior edges of the rear position lamps must be observed, and they must have a vertical angle of visibility above the horizontal of 15°.
- 6.9.5.1.2. The other two shall keep within a maximum height of 4,000 mm above the ground and shall be bound by the requirements of paragraph 6.9.4.1.
- 6.9.5.1.3. The combination of the two pairs must meet the requirements for geometric visibility as specified in 6.9.5 above."

Paragraph 6.9.7., amend to read:

"6.9.7. Electrical connections: No individual specifications (see 5.11)."

Paragraph 6.9.8., amend to read:

"6.9.8. "Circuit closed" tell-tale: Mandatory (~~see 5.11~~). It must be combined with that of the front position lamps."

Paragraph 6.12.1., amend to read:

"6.12.1. Presence: **Mandatory on vehicles exceeding 2,550 mm in width.** Optional on vehicles ~~exceeding~~ between 1,800 mm **and 2,550 mm** in width. ~~Prohibited on all other vehicles.~~"

Paragraph 6.12.2., amend to read:

"6.12.2. Number: Two visible from the front and two visible from the rear.

Optional: additional lamps may be fitted as follows:

(a) Two visible from the front;

(b) Two visible from the rear."

Paragraph 6.12.4.2., amend to read:

"6.12.4.2. Height: ~~At the greatest height compatible with the required position in width and with symmetry of the lamps.~~

At the maximum height compatible with the requirements relating to the width, design and operational requirements of the vehicle and to the symmetry of the lamps.

Both optional and mandatory (as applicable) lamps to be fitted as far separated in height as practicable and compatible with design/operational requirements of the vehicle and symmetry of the lamps."

Paragraph 6.14.1., amend to read:

"6.14.1. Presence: **Mandatory on vehicles of category T. Prohibited on vehicles of categories R and S."**

Paragraph 6.14.2., amend to read:

"6.14.2. Number: Two or four (see paragraph 6.14.5.1).

The performances of these devices shall conform to the requirements concerning Class IA or IB retro-reflectors in Regulation No. 3. Additional retro-reflecting devices and materials (including two retro-reflectors not complying with

paragraph 6.14.4. below), are permitted provided they do not impair the effectiveness of the mandatory lighting and light-signalling devices."

Paragraph 6.15.1., amend to read:

"6.15.1. Presence:

Mandatory on ~~tractors~~ **vehicles of category T** the length of which exceeds 6 m **and on all vehicles of categories R and S.**

Optional on tractors the length of which does not exceed 6 m."

Paragraph 6.15.4.3., amend to read:

"6.15.4.3. Length:

One reflector must be not more than 3 m from the foremost point of the ~~tractor~~ **vehicle**, and either the same reflector or a second reflector must be not more than 3 m from the rearmost point of the ~~tractor~~ **vehicle**. **For vehicles of category R and S the distance between the rearmost side retro-reflector and the rear of the vehicle shall not exceed 1 m.**

The distance between two reflectors on the same side of the ~~tractor~~ **vehicle** must not exceed ~~6~~ **3** m. **If the structure, design or the operational use of the vehicle makes it impossible to comply with such a requirement, this distance may be increased to 4 m."**

Paragraph 6.17.1., amend to read:

"6.17.1. Presence:

Optional **on vehicles of category T. Mandatory on vehicles of categories R and S."**

Paragraph 6.17.4.1., amend to read:

"6.17.4.1. Width:

That point on the illuminating surface which is farthest from the vehicle's median longitudinal plane shall not be more than 400 mm **and for vehicles of category R and S not more than 150 mm** from the extreme outer edge of the vehicle.

The distance between the inner edges of the two apparent surfaces in the direction of the reference axes shall be not less than 600 mm. This distance may be reduced to 400 mm where the overall width of the vehicle is less than 1,300 mm."

Paragraph 6.17.5.1., amend to read:

"6.17.5.1.

If it is impossible to observe the above position and visibility requirements, four front retro-reflectors may be fitted in accordance with the following installation specifications:

6.17.5.1.1.

If fitted, two reflectors shall keep within the maximum height of 1,200 mm above the ground.

A distance of at least 300 mm between the interior edges of the front retro-reflectors must be observed, and they must have a vertical angle of visibility above the horizontal of 15°.

6.17.5.1.2.

The other two shall keep within a maximum height of 2,500 mm above the ground and shall be bound by the requirements of paragraph 6.17.4.1.

6.17.5.1.3.

The combination of the two pairs shall meet the requirements for geometric visibility as specified in paragraph 6.17.5."

Paragraph 6.18.1., amend to read:

"6.18.1. Presence:

Mandatory on all vehicles of categories T and R exceeding 6 m in length.

Optional on all other vehicles."

Paragraph 6.19.1., amend to read:

"6.19.1. Presence:

Optional on vehicles of category T. Prohibited on vehicles of categories R and S."

Paragraph 6.20.1., amend to read:

"6.20.1. Presence:

Optional on vehicles of category T. Prohibited on vehicles of categories R and S."

Paragraph 6.23.1., amend to read:

"6.23.1. Presence:

Optional on vehicles of category T. Prohibited on vehicles of categories R and S."

Paragraph 6.24.1., amend to read:

"6.24.1. Presence

Optional on vehicles of category T. Prohibited on vehicles of categories R and S."

Insert a new paragraph 6.25., to read:

"6.25. Rear retro-reflectors, triangular (Regulation No. 3)

6.25.1.	Presence:	Mandatory on vehicles of categories R and S. Prohibited on vehicles of category T.
6.25.2.	Number:	Two or four (see paragraph 6.25.5.1.).
6.25.3.	Arrangement:	The apex of the triangle shall be directed upwards.
6.25.4.	Position	
6.25.4.1.	Width:	Except as provided in paragraph 6.25.5.1. the point on the illuminating surface which is farthest from the vehicle's median longitudinal plane shall be not more than 400 mm from the extreme outer edge of the vehicle. The inner edges of the retro-reflectors shall be not less than 600 mm apart. This distance may be reduced to 400 mm where the overall width of the vehicle is less than 1,300 mm.
6.25.4.2.	Height:	<p>Except as provided in paragraph 6.25.5.1., not less than 400 mm and not more than 1,500 mm above the ground.</p> <p>For vehicles with a maximum width not exceeding 1,300 mm above the ground not less than 250 mm.</p>
6.25.4.3.	Length:	No individual specifications.
6.25.5.	Geometric visibility:	<p>Horizontal angle: 30° inwards and outwards.</p> <p>Vertical angle: 15° above and below the horizontal. The vertical angle below the horizontal may be reduced to 5° if the height of the reflector is less than 750 mm.</p>
6.25.5.1.		If it is impossible to observe the above position and visibility requirements, four retro-reflectors may be fitted in accordance with the following installation specifications:
6.25.5.1.1.		<p>Two retro-reflectors must keep within the maximum height of 900 mm above the ground. However, this upper limit may be increased to not more than 1,200 mm if it is impossible to keep within the height of 900 mm without having to use fixing devices liable to be easily damaged or bent.</p> <p>A distance of at least 300 mm between the interior edges of the reflectors must be observed, and they must have a vertical angle of visibility above the horizontal of 15°.</p>

- 6.25.5.1.2. The other two shall keep within a maximum height of 2,500 mm above the ground and shall be bound by the requirements of paragraph 6.25.4.1.
- 6.25.6. Alignment: Towards the rear.
- 6.25.7. Other requirements: The illuminating surface of the retro-reflector may have parts in common with that of any other rear lamp."

Insert a new paragraph 6.26., to read:

- "6.26. Signalling panel and signalling foil (Regulations Nos. 70 and 104)
- 6.26.1. Presence: Mandatory on vehicles exceeding 2,550 mm in width.
Optional on vehicles of category S not exceeding 2,550 mm in width.
- 6.26.2. Number: Two or four (Annex 6).
- 6.26.3. Arrangement: According to the specifications of Annex 6.
- 6.26.4. Position
Width: That point on the illuminating surface of at least one entire basic standard area which is farthest from the vehicle's median longitudinal plane shall not be more than 100 mm from the extreme outer edge of the vehicle. This value may be increased if the shape of the bodywork makes it impossible to keep within 100 mm.
Height: No individual specifications.
Length: No individual specifications.
- 6.26.5. Geometric visibility: No individual specifications.
- 6.26.6. Alignment: Towards the front and the rear."

Insert a new paragraph 12., to read:

- "12. Transitional provisions
- 12.1. As from the official date of entry into force of the 01 series of amendments, no Contracting Party applying this Regulation shall refuse to grant or refuse to accept type approvals under this Regulation as amended by the 01 series of amendments.
- 12.2. As from 24 months after the date of entry into force of the 01 series of amendments, Contracting Parties applying this Regulation shall grant type approvals only if the vehicle type to be approved meets the requirements of this Regulation as amended by the 01 series of amendments.
- 12.3. Contracting Parties applying this Regulation shall not refuse to grant extensions of type approvals for existing types which have been granted according to the preceding series of amendments to this Regulation.

- 12.4. **Until 24 months after the date of entry into force of the 01 series of amendments to this Regulation, no Contracting Party applying this Regulation shall refuse national or regional type approval of a vehicle type-approved to the preceding series of amendments to this Regulation.**
- 12.5. **As from 24 months after the date of entry into force of the 01 series of amendments to this Regulation, Contracting Parties applying this Regulation shall not be obliged to accept, for the purpose of national or regional type approval, a vehicle type approved to the preceding series of amendments to this Regulation.**
- 12.6. **Notwithstanding the transitional provisions above, Contracting Parties whose application of this Regulation comes into force after the date of entry into force of the 01 series of amendments are only obliged to accept type approval granted in accordance with the 01 series of amendments."**

Annex 1, item 5.16., amend to read:

"5.16. Rear retro-reflectors, **non-triangular**: yes/no³"

Annex 1, item 5.21., amend to read:

"5.21. Daytime running lamps: yes/no³"

Annex 1, item 5.22., amend to read:

"5.22. Cornering lamps: yes/no³"

Annex 1, insert new item 5.26., to read:

"**5.26. Exterior courtesy lamps: yes/no³**"

Annex 1, insert new item 5.27., to read:

"**5.27. Signalling panels or signalling foils: yes/no³**"

Annex 1, insert new item 5.28., to read:

"**5.28. Rear retro-reflectors, triangular: yes/no³**"

Annex 2, amend to read:

"Annex 2

Examples of arrangements of approval marks

Model A
(See paragraph 4.4. of this Regulation)

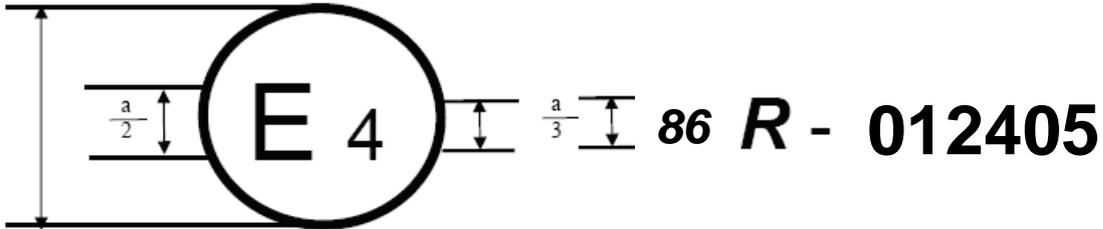

$Aa = 8 \text{ mm min.}$

The above approval mark affixed to an agricultural or forestry vehicle shows that the vehicle type concerned has, with regard to the installation of lighting and light-signalling devices, been approved in the Netherlands (E 4) pursuant to Regulation No. 86. The approval number indicates that the approval was granted in accordance with the requirements of Regulation No. 86 ~~in its original form~~ **as amended by the 01 series of amendments.**

Model B
(See paragraph 4.5. of this Regulation)

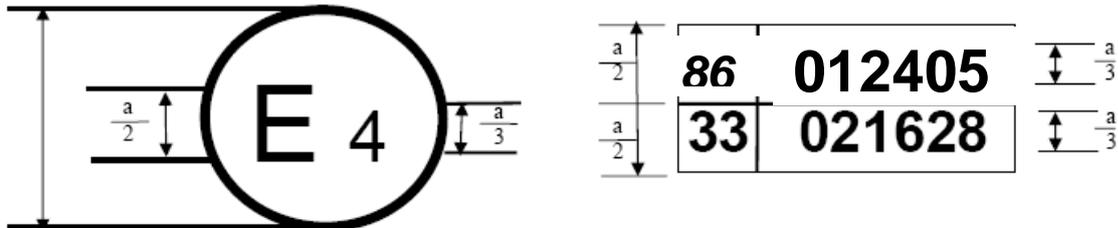

$Aa = 8 \text{ mm min.}$

The above approval mark affixed to an agricultural or forestry vehicle shows that the vehicle type concerned has been approved in the Netherlands (E 4) pursuant to Regulations Nos. 86 and 33*. The approval numbers indicate that, at the dates when the respective approvals were given, Regulation No. 86 was ~~in its original form~~ **as amended by the 01 series of amendments** and Regulation No. 33 already included the 02 series of amendments."

* The latter number is given merely as an example.

Annex 5, amend to read:

"Annex 5

Direction-indicator lamps - Geometric visibility

(see paragraph 6.5.54.)

Arrangement A

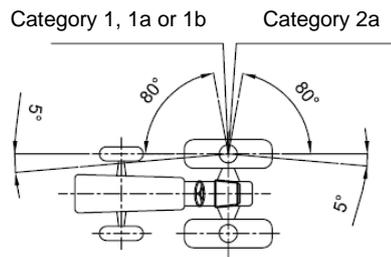

Arrangement B

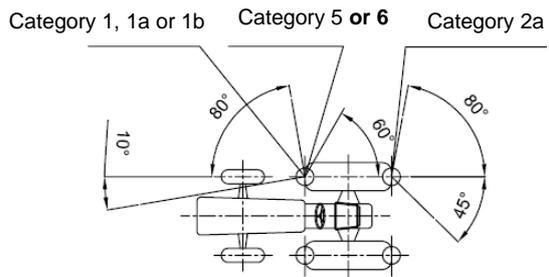

Arrangement C

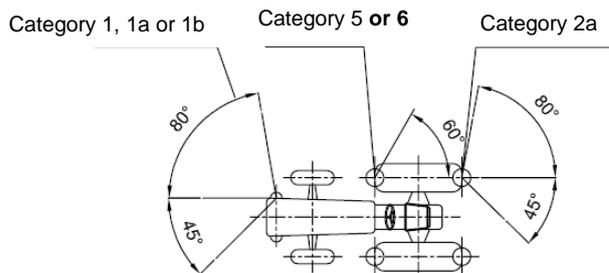

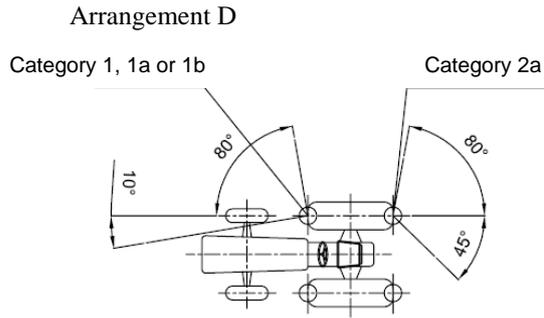

For all the arrangements the following applies:

The value 10° given for the inward angle of visibility of the front indicator may be reduced to 3° for vehicles with an overall width not exceeding 1,400 mm.

For rear direction indicators, the horizontal inward angle may be reduced to 30° if the shape of the bodywork makes it impossible to reach 45°."



Insert a new Annex 6, to read:

"Annex 6

Signalling panels and signalling foils

1. Dimensions, arrangement, number and minimum reflecting surface
 - 1.1. Signalling panels and signalling foils shall have the following dimensions:

Figure 1.
Basic standard area

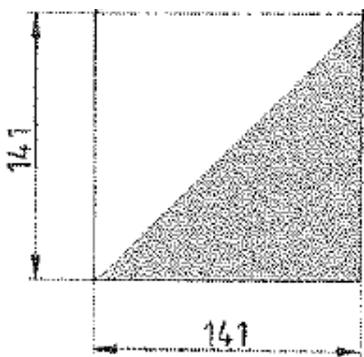

Figure 2.
Signalling panel or signalling foil

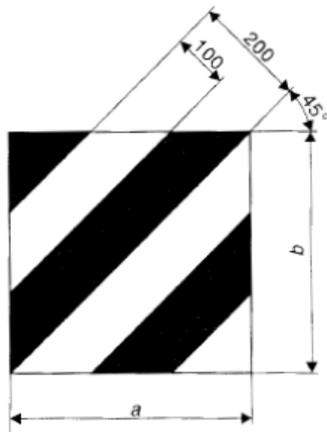

Table 1
Dimensions [mm]

<i>Signalling panel or signalling foil</i>	<i>a [mm]</i>	<i>b [mm]</i>	<i>Surface [cm²]</i>
Form A	423	423	1,790
Form B	282	282	795
Form R1	282	423	1,193
Form R2	423	282	
Form L1	141	846	1,193
Form L2	846	141	
Form K1	141	423	596
Form K2	423	141	

Deviations from the specified formats are permitted, provided that:

- a) the visible surface of each panel or foil shall be at least equal to 4 basic standard areas and
- b) each panel or foil shall comprise at least 3 entire basic standard areas.

If the structure, design or the operational use of the vehicle makes it impossible to comply with such a requirement, each panel or foil may be split into 2 parts as long as each part comprises at least 2 entire basic standard areas.

1.2. Arrangement

The panels or foils shall be arranged in a way that their stripes shall run under 45° outwards and downwards.

Table 2
Number of panels or foils visible from the front and from the rear

<i>Signalling panel or signalling foil</i>	<i>Number visible from the front</i>	<i>Number visible from the rear</i>
Form A	2	2
Form B	2	2
Form R1	2	2
Form R2		
Form L1	2	2
Form L2		
Form K1	4	4
Form K2		

2. Colours and photometric minimum requirements

Each panel or foil shall be according to the specifications of Regulation No. 70 class 5 or Regulation No. 104 class F.

II. Justification

1. A European Committee of Associations of Manufacturers of Agricultural machinery (CEMA) project team and a Committee of German experts from Industry, Technical Services and other organizations prepared proposals to amend the existing Regulation No. 86 which was further developed by AVLI during Phase I of its work.
2. Phase I was completed with a proposal for amendment to Regulation No. 86 which was presented and adopted by GRE during its seventy-second session.
3. For the inclusion of agricultural trailers and interchangeable towed equipment, new definitions for agricultural trailers (Category R) and interchangeable towed equipment (Category S) were needed in the Consolidated Resolution R.E.3. AVLI prepared a proposal for such definitions and the secretariat presented it in 2014 to the other Working Parties for consideration.
4. The European Commission subsequently proposed improved definitions, based on the AVLI proposal, in order to avoid conflict with the existing EU definitions.
5. In parallel, the extension of the scope of Regulation No. 86 and appropriate requirements for vehicles of categories R and S were prepared and discussed in AVLI. This Phase II contains the following:
 - (a) extension of the scope by adding R and S category vehicles;
 - (b) in section "presence", the applicability for vehicles of categories R and S is added;
 - (c) where appropriate, individual requirements for vehicles of categories R and S are added (e.g. side retro-reflectors, non-triangular);
 - (d) rear retro-reflectors, triangular are included;
 - (e) signalling panels and signalling foils are included (mandatory in certain cases);
 - (f) mandatory main-beam headlamps for tractors with a maximum design speed above 40 km/h;
 - (g) mandatory side-marker lamps for certain vehicle categories exceeding 6 m in length;
 - (h) prohibit "Arrangement D" for direction indicators for tractors exceeding 4,600 mm in length;
 - (i) include a new small amendment related to the horizontal inward visibility angle of rear direction indicators, rear position lamps and stop lamps to allow a reduced angle of inwards visibility of 30° instead of 45°. This is to consider the needs and special design characteristics of certain "non-conventional" tractors or towed vehicles. The same reduced value of 30° is already used for retro-reflectors, side-marker lamps and reversing lamps;
 - (j) introduction of mandatory front position lamps for vehicles of category R and S exceeding a width of 1,600 mm. However, a derogation is proposed in case of vehicles where the shape, structure, design or operational requirements of the vehicle make it impossible to install such lamps. This proposed derogation was put in square brackets [] for final consideration by GRE. Furthermore, the front position lamps may be omitted if end-outline marker lamps are installed and meet all the installation requirements for front position lamps;
 - (k) some further editorial corrections and clarifications added.
6. Transitional provisions for the 01 series of amendments are included.