

Distr.: General  
28 September 2012

English only

---

## Economic Commission for Europe

### Inland Transport Committee

#### Working Party on Customs Questions affecting Transport

##### 132nd session

Geneva, 9–12 October 2012

Item 8 (c) (v) of the provisional agenda

##### **Customs Convention on the International Transport of Goods under Cover of TIR Carnets (TIR Convention, 1975):**

##### **Application of the Convention – Vehicles with sliding sheets**

### **Vehicles with sliding sheets**

#### **Note by the secretariat**

#### **I. Introduction**

At its previous session, the Working Party considered document ECE/TRANS/WP.30/2012/6 submitted by the International Association of the Body and Trailer Building Industry (CLCCR) a new design of vehicles with sliding sheets. Given the highly technical nature of this issue, WP.30 invited delegations to discuss these proposals with national experts and report back to the Working Party at its present session (ECE/TRANS/WP.30/262, para. 34).

To facilitate considerations by WP.30, the secretariat has taken the liberty to contact a well-known technical expert, who contributed to the work of WP.30 in the past, with a request to comment on the revised proposals by CLCCR as laid down in document ECE/TRANS/WP.30/2012/6/Rev.1. His comments (together with additional photos) are reproduced below in **bold**, next to the proposals they are referring to.

#### **II. Comments received**

...

##### Sketch No. 10.1

To tighten the tarpaulin in the horizontal direction, a ratchet gear is used (normally on the rear end of the container). This sketch shows two examples (a. and b.) how the ratchet or gearbox may be secured.

(a) Ratchet securing

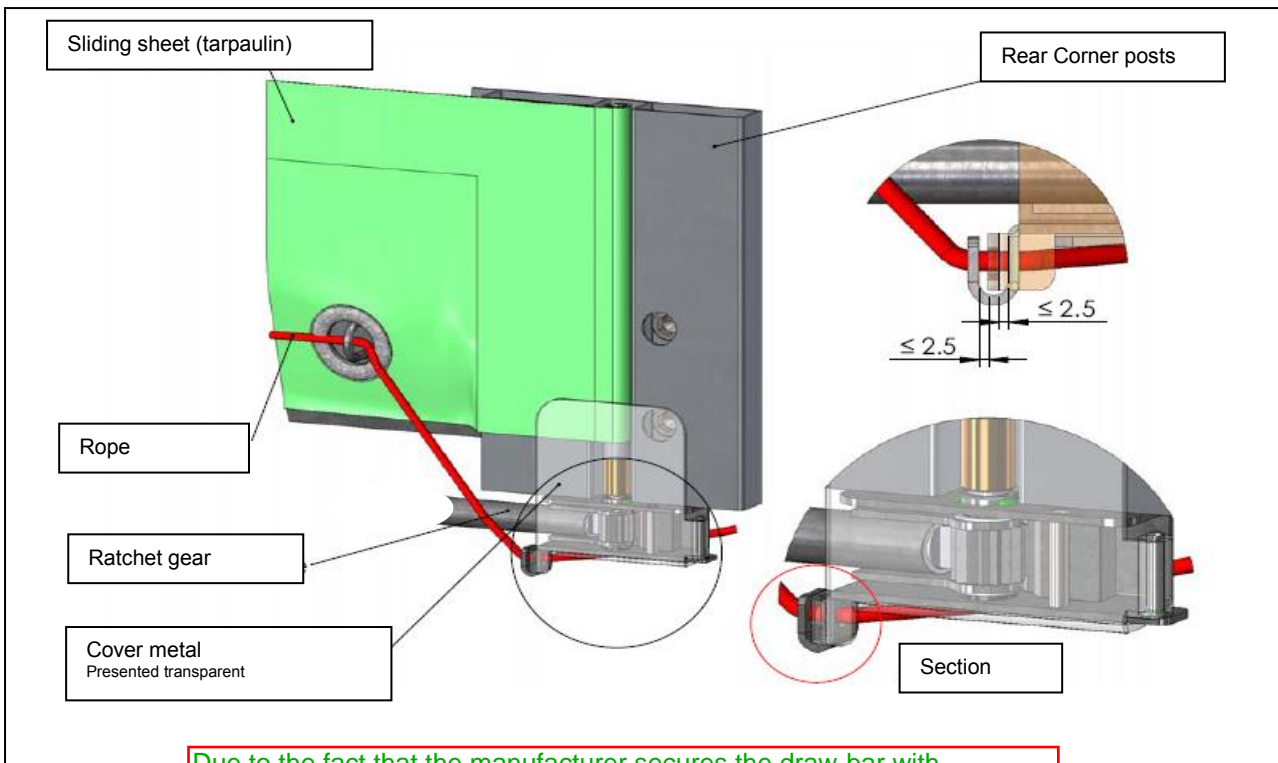

The place where the draw-bar/tensioning bar connects to the square axle exiting the ratchet system **MUST** be covered and protected by a metal-plate, and this plate **MUST** be secured by the rope/TIR wire. The square axle exiting the ratchet system is normally between 15 and 20 mm high and it is possible to force the draw-bar/tensioning bar off the axle – a big screwdriver and a few pushes is enough.

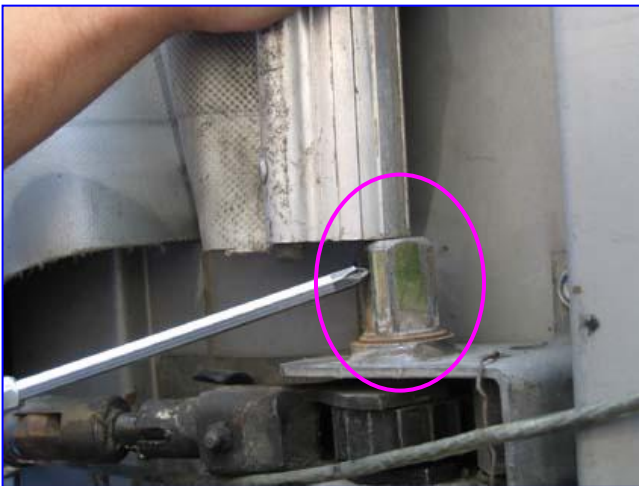

**LEFT:** Ratchet release system – note the height of the square axle: 20 mm only!

**RIGHT:** Alost similar ratchet system – lock system for the handle secured by the rope/TIR wire + metal-plate covering the connection of the draw-bar/tensioning bar secured a system of eyelets, TIT rings and the rope/TIR wire.

(b) Gearbox securing

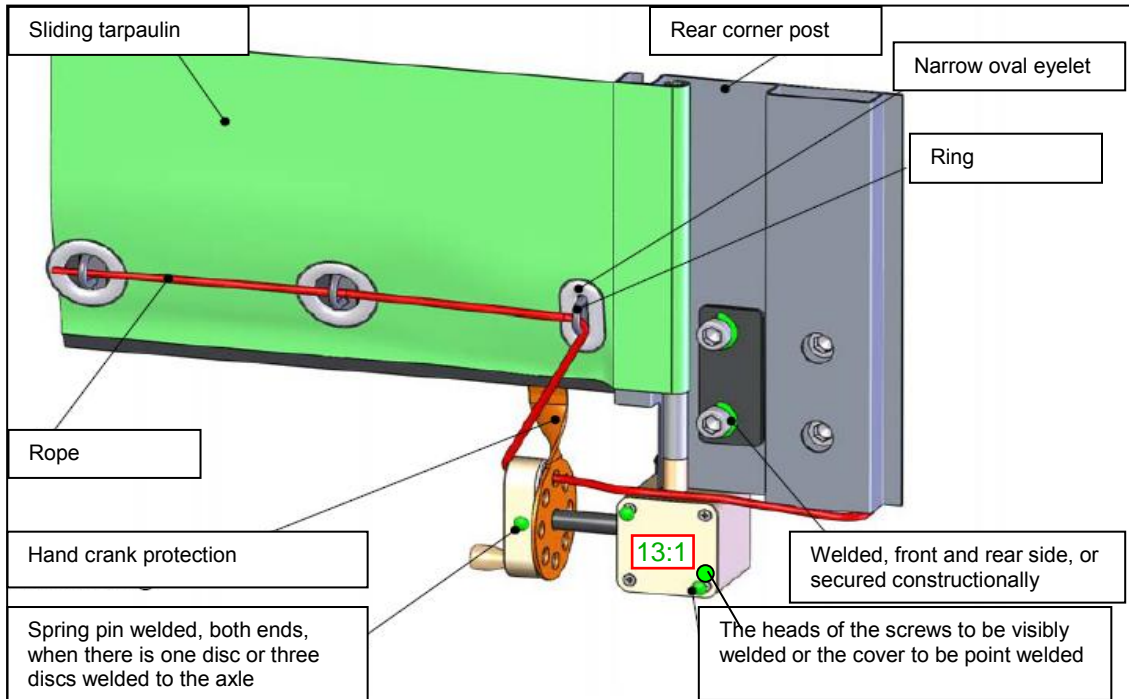

It is not possible, due to the fact that the crank protection is welded to the chassis and the gearbox with the shaft is also welded. These are two fixed points which has the effect that it is not possible to force this 4mm (thick) single plate more than 2.5 mm away from the hand crank.

Arrow pointing at a single plate mounted in order to prevent rotation of the hand crank. It is quite easy to force this single plate away from the handle making 6-8 mm space between the hand crank and the plate – which makes it possible to rotate the handle. It is ALWAYS possible to find extra (loose) 15-25 cm of rope (TIR-wire), especially where the customs seal is affixed. The system preventing the handle to be rotated MUST consist of a 3-plate system – as illustrated by CLCCR (WP.30 – 2007 presentation).

The standard gear rotation is 13:1. That means you have to spin 13 times by one turn of the tensioning bar.

Oval shows the “brass” end-piece connection to the square axle from the gearbox and the visible end (app. 6-8 cm) of the “hollow” draw-bar/tensioning bar. The sheet/tarpaulin can easily “slide” up-down inside the draw-bar.

Before the custom authority take the trailer under custom seal, they have to prove, if the TIR rope is tight enough. So mentioned in Annex 2 Article 2 "Examples of Customs sealing devices. Page 136



Example – sealing: 25 cm loose/additional



3-plate system - preventing

rope/wire.

rotation.

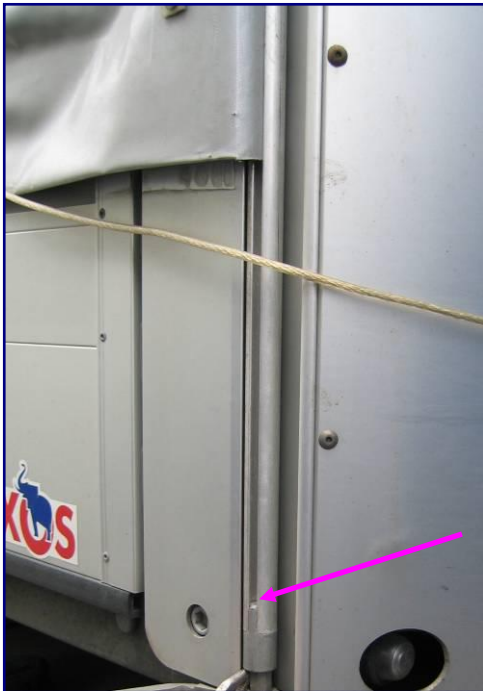

Photo of the “hollow” draw-bar on a vehicle with sideboards and sliding sheet. The draw bar can easily move up-down as the sheet is not fixed to the bar – quite big open slid in the draw-bar.

- This is not a TIR trailer!
- The sheet is fixed to the bar and it is not possible that the sheet is moved up or down the bar.
- Anyway, if the sliding sheet is tight in horizontal direction, it is not possible to move the tarpaulin up or down.

YES

NO - not possible without leaving obvious traces.

YES

It is quite easy to lift the draw-bar off its base – also if it is pulled tight. The most difficult part is to reinstall. Often a special prepared pipe wrench or tong is required, and I have only once seen this adapted wrench unfortunately I have no photo available. If the slid is visible it is possible to use the top of the end piece to force the draw bar back in place (arrow).

This text is correct for systems shown in the pictures - but these trailers are NOT TIR - trailers.



Picture of an end-piece with square lower part. This end-piece (and draw-bar) can easily be rotated by using a normal wrench. Also the opening where the sheet is inserted in the draw-bar is accessible. Note the gap between the sheet and the end-piece (app 2,5 cm) – the sheet can slide this distance inside the draw-bar.

No, due to the fact that the sheet is affixed to the draw bar, it is not possible to slide in the draw-bar.





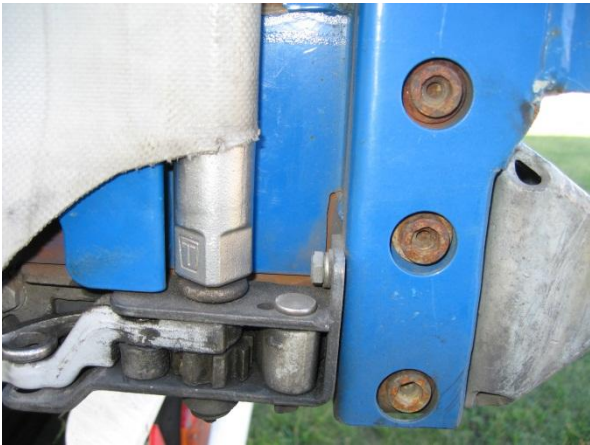

Same type of end-piece – located at the REAR of the trailer.

This trailer is not for TIR transport!

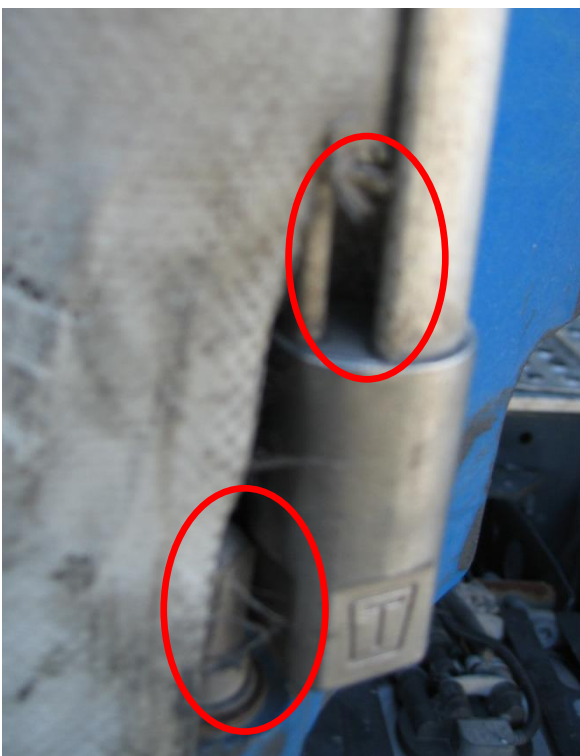

Note the slid / space between end-piece and sheet – it is equal to the height of the square base for the draw-bar. This allows for movement the draw-bar – up/down.

**Sketch No.10.2**

To fix the tarpaulin on the other side (normally to the front of the container) the following systems (a. or b.) may be used.

(a) Cover metal

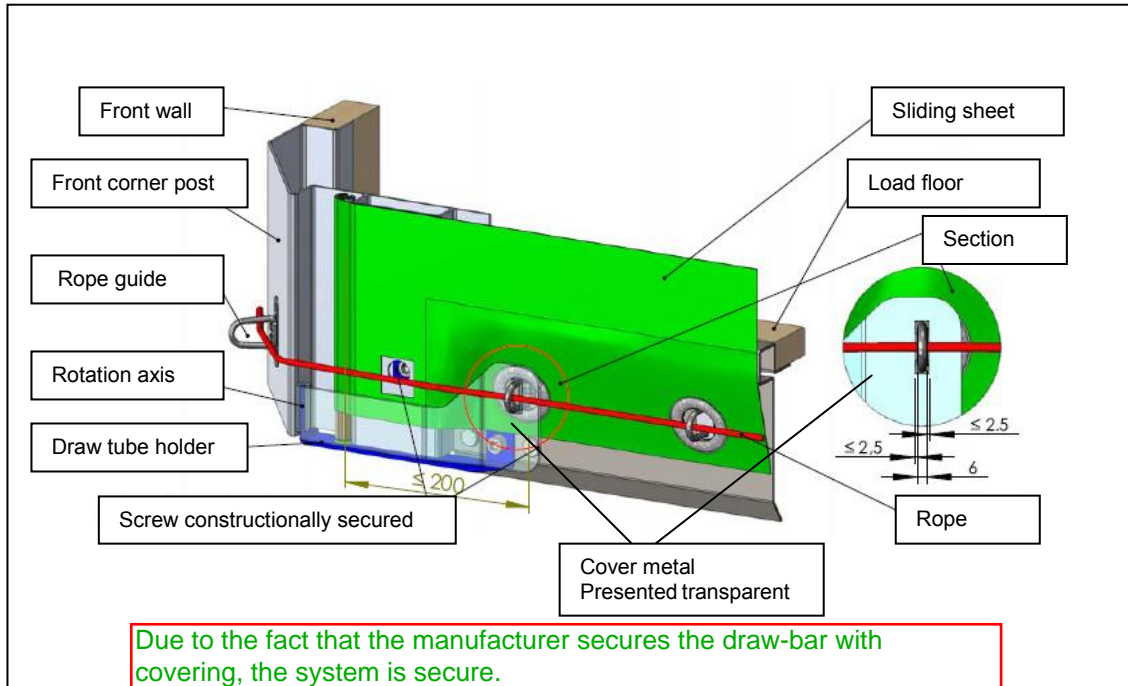

The system above I consider being secure – due to the metal plate covering the base and end-piece of the draw-bar. There is no access for tools needed to lift off the bar.

(b) Narrow oval eyelet, anti lifting system for the tensioning tube

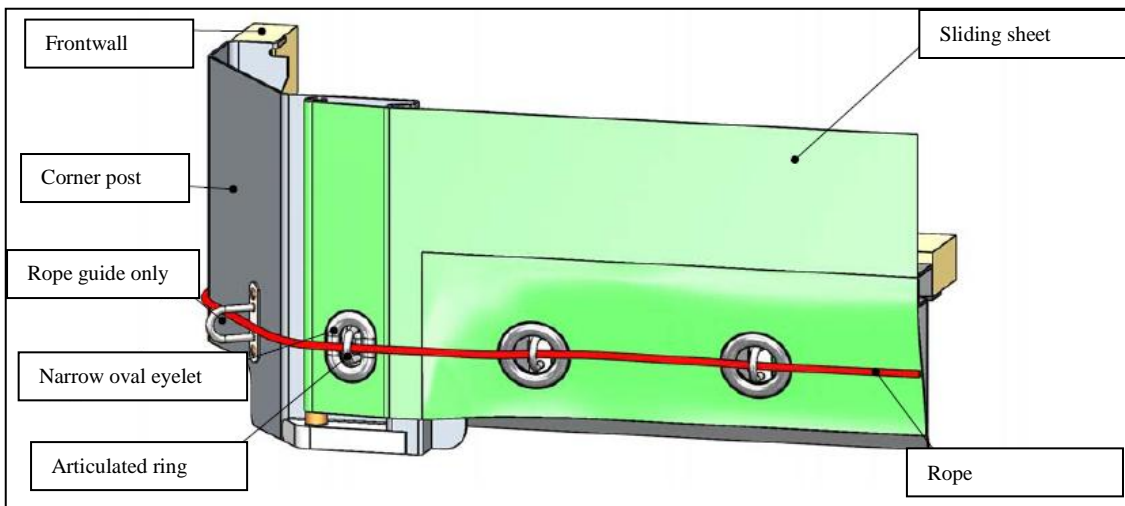

**NO**

Although an eyelet/TIR-ring is located quite close to the draw-bar, I still consider this system to be non-secure. There is access to the base for the draw-bar – and bearing in mind that the sheet can slide inside the hollow draw-bar the bar can be lifted (forced) off the base. Again the difficult part is to put it nicely back again (tighten the sheet).

6

- The sheet is fixed to the hollow draw bar. It can NOT slide inside the draw bar.
- The narrow oval eyelet makes it impossible to lift up the draw bar from base.
- This picture shows an example. It was not possible to lift up the draw bar. To put it from the base you need additional 15mm.
- With this test the draw bar was already damaged.

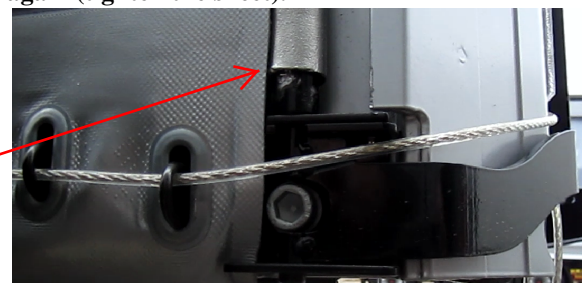

Sketch 10.3

The custom security of the sliding roof is guaranteed if a pre-stressed steel rope, embedded in a hemline, is fixed. This steel rope is fixed to the front and rear of the container. The tractive force as well as the connecting disc on each sliding carriage, makes it impossible to lift up the hemline with the steel rope above the upper cantrail.

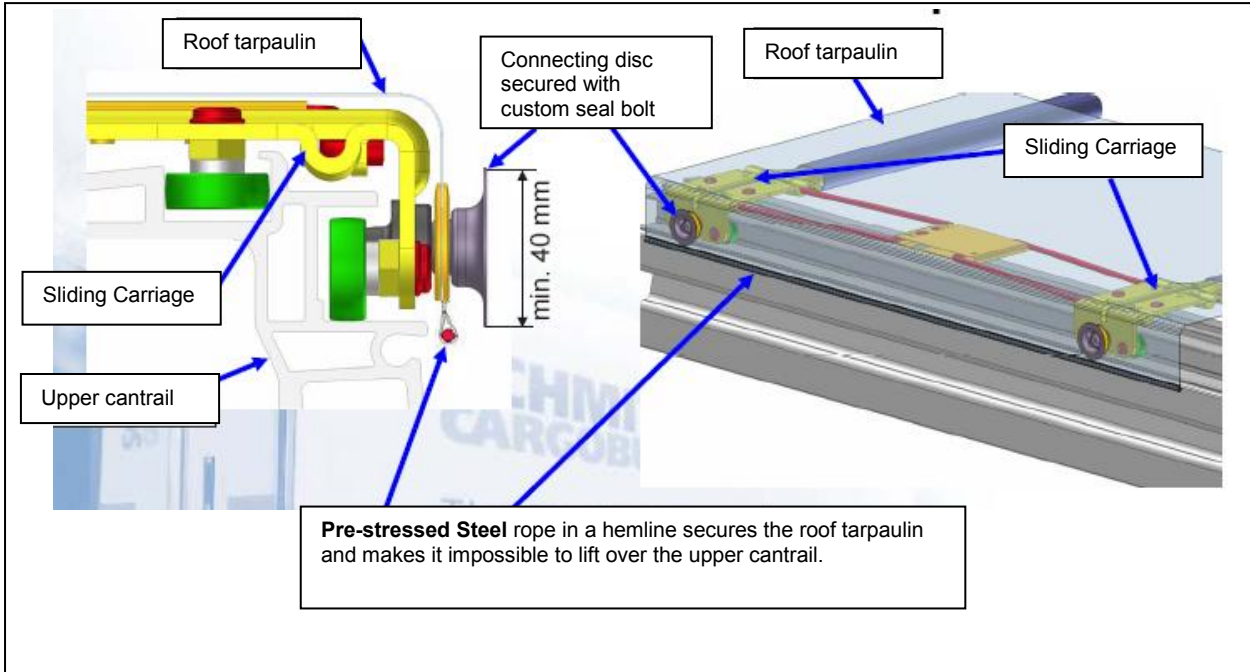

Most sliding roofs are seen having only wheels at the side of the carriage – and this new system is an improvement. The carriage is significantly stronger and better due to the system of wheels both at the upper part and at the side of the cantrail.

However it is a **MUST** that it is not possible to put a hand through and behind the sheet (behind the pelmet covering the sheet along the side of the vehicle). The system above shows the normal distance between the upper crossbars (main carriages) – no additional rollers/bearings mounted, and I am convinced that it is possible to get a hand inside the vehicle. Again I have to refer to the vehicles presented by CLCCR – on this trailer two additional wheels/bearings is mounted to the sheet at the upper cantrail – see photo below.

The distance of the carriages is chosen such that the tension of the steel rope in the hemline prevents a complete reaching above the upper cantrail.

The possible access is similar shown by the picture on the following page.







**Green = Main carriages – seen from outside under the pelmet – distance app. 60 cm.  
Purple = TWO additional wheels/bearings.**

**The two additional wheels/bearings are preventing a hand to pass.**



**This additional system must most likely also be mounted on the roof tarpaulin/sheet – just over the hemline. On the sketch it is rather difficult to see the actual structure of the upper cantrail and therefore not possible to establish the wideness of the cantrail. Along the side an overlap of the solid parts is required (normally/standard is 15 cm) – ¼ of the distance between the rollers/wheels). The same overlap should also be in place at the roof as the cantrail is considered being “a solid part of the vehicle”.**

**It is always difficult to comment on security measures based on sketches only – having the exact trailer/vehicle in front of you is far better. And of course all systems must be thoroughly tested and challenged – just as they are in real life.**

**We assume that the comments from the technical expert are a result of this fact.**