

E/ECE/324 }
E/ECE/TRANS/505 } Rev.2/Add.115

18 April 2005

AGREEMENT

CONCERNING THE ADOPTION OF UNIFORM TECHNICAL PRESCRIPTIONS FOR WHEELED VEHICLES, EQUIPMENT AND PARTS WHICH CAN BE FITTED AND/OR BE USED ON WHEELED VEHICLES AND THE CONDITIONS FOR RECIPROCAL RECOGNITION OF APPROVALS GRANTED ON THE BASIS OF THESE PRESCRIPTIONS */

(Revision 2, including the amendments which entered into force on 16 October 1995)

Addendum 115: Regulation No. 116

Date of entry into force: 6 April 2005

UNIFORM TECHNICAL PRESCRIPTIONS CONCERNING THE PROTECTION OF MOTOR VEHICLES AGAINST UNAUTHORIZED USE



UNITED NATIONS

*/ Former title of the Agreement:

Agreement Concerning the Adoption of Uniform Conditions of Approval and Reciprocal Recognition of Approval for Motor Vehicle Equipment and Parts, done at Geneva on 20 March 1958.

Regulation No. 116

UNIFORM TECHNICAL PRESCRIPTIONS CONCERNING THE PROTECTION
OF MOTOR VEHICLES AGAINST UNAUTHORIZED USE

CONTENTS

REGULATION	<u>Page</u>
1. Scope	6
2. Definitions : General	7
3. Application for approval	7
4. Approval.....	7
 5. PART I: APPROVAL OF A VEHICLE OF CATEGORY M1 AND N1 WITH REGARD TO ITS DEVICES TO PREVENT UNAUTHORIZED USE	
5.1. Definitions	9
5.2. General specifications	10
5.3. Particular specifications	12
5.4. Electromechanical and electronic devices to prevent unauthorized use.....	14
 6. PART II: APPROVAL OF VEHICLE ALARM SYSTEMS	
6.1. Definitions.....	15
6.2. General specifications	16
6.3. Particular specifications	17
6.4. Operation parameters and test conditions	22
6.5. Instructions	27
 7. PART III: APPROVAL OF A VEHICLE WITH REGARD TO ITS ALARM SYSTEM	
7.1. Definitions	28
7.2. General specifications	28
7.3. Particular specifications	29
7.4. Test conditions	34
7.5. Instructions	35
 8. PART IV: APPROVAL OF IMMOBILIZERS AND APPROVAL OF A VEHICLE WITH REGARD TO ITS IMMOBILIZER	
8.1. Definitions.....	35
8.2. General specifications	36
8.3. Particular specifications	38
8.4. Operation parameters and test conditions	39

CONTENTS (continued)

8.5.	Instructions	40
9.	Modification of the type and extension of approval	41
10.	Conformity of production procedures	42
11.	Penalties for non-conformity of production	42
12.	Production definitely discontinued	42
13.	Transitional provisions	42
14.	Names and addresses of technical services responsible for conducting approval tests, and of administrative departments	43

ANNEXES

Annex 1 - Information document:

- Part 1: in accordance with paragraphs 5., 7. and 8. as appropriate of Regulation No. 116 relating to ECE system type approval of a vehicle type with regard to the devices to prevent unauthorized use
- Part 2: in accordance with paragraph 6. of Regulation No. 116 relating to ECE component type approval of an alarm system
- Part 3: in accordance with paragraph 8. of Regulation No. 116 relating to ECE component type approval of an immobilizer system

Annex 2 - Communication concerning approval granted, extended, refused, withdrawn, production definitively discontinued:

- Part 1: of a vehicle type with regard to its devices to prevent unauthorized use pursuant to Regulation No. 116
- Part 2: of a component type as an alarm system pursuant to Regulation No. 116
- Part 3: of a component type as an immobilizer pursuant to Regulation No. 116

Annex 3 - Arrangements of approval marks

- Annex 4 - Part 1: Wear producing test procedure for devices to prevent unauthorized use acting on the steering
- Part 2: Test procedure for devices to prevent unauthorized use acting on the steering using a torque limiting device

Annex 5 - Electrically powered system test

CONTENTS (continued)

- Annex 6 - Model of certificate of conformity
- Annex 7 - Model of installation certificate
- Annex 8 - Test of systems for the protection of the passenger compartment
- Annex 9 - Electromagnetic compatibility
- Annex 10 - Specifications for mechanical key switches

1. SCOPE

This Regulation applies to:

- 1.1. PART I - Approval of a vehicle of category M1 and N1 1/ with regard to its devices to prevent unauthorized use.
- 1.2. PART II - Approval of vehicle alarm systems (VAS) which are intended to be permanently fitted to vehicles of category M1 and those of category N1 with a maximum mass of not more than 2 tonnes 1/.
- 1.3. PART III - Approval of vehicles of category M1 and those of category N1 with a maximum mass of not more than 2 tonnes, with regard to their alarm system(s) 2/.
- 1.4. PART IV - Approval of immobilizers and vehicles of category M1 and vehicles of category N1 with a maximum mass of not more than 2 tonnes with regard to immobilizers 2/ 1/.
- 1.5. The fitting of devices specified under Part I to vehicles of other categories is optional but any such device fitted is required to comply with all relevant provisions of this Regulation.
- 1.6. The fitting of devices specified under Parts III and IV to vehicles of other categories, or to N1 category vehicles with a maximum mass exceeding 2 tonnes, is optional but any such device fitted is required to comply with all relevant provisions of this Regulation.
- 1.7. At the request of the manufacturer, Contracting Parties may grant approvals under Parts I to IV to vehicles of other categories and devices for fitment to such vehicles.
- 1.8. At the time of application of this Regulation, Contracting Parties shall declare which parts of the Regulation they intend to mandate in their territory for each category of vehicles 3/.

1/ As defined in the Consolidated Resolution on the Construction of Vehicles (R.E.3), Annex 7 (document TRANS/WP.29/78/Rev.1, as amended).

2/ Only vehicles with 12 volts electrical systems are considered.

3/ It is recommended that Contracting Parties apply Parts I and IV to approval of M1 category vehicles and Part I only to approval of N1 category vehicles, the other requirements remaining optional. Parts II, III and IV should apply where such equipment is fitted to vehicle categories shown in paragraphs 1.3. to 1.5.

2. DEFINITIONS: GENERAL

- 2.1. "Manufacturer" means the person or body who is responsible to the approval authority for all aspects of the type approval process and for ensuring conformity of production. It is not essential that the person or body is directly involved in all stage of the construction of the vehicle, system, component or separate technical unit which is the subject of the approval process.

3. APPLICATION FOR APPROVAL

- 3.1. The application for approval of a vehicle or component type with regard to this Regulation shall be submitted by the manufacturer.
- 3.2. It shall be accompanied by an information document in accordance with the model shown in Annex 1, Part 1, 2 or 3 as appropriate.
- 3.3. Vehicle(s) / component(s) representative of the type(s) to be approved shall be submitted to the technical service responsible for conducting the approval tests.

4. APPROVAL

- 4.1. If the type submitted for approval to this Regulation meets the requirements of the relevant part(s) of this Regulation, approval of that type shall be granted.
- 4.2. An approval number shall be assigned to each type approved. Its first two digits (at present 00, corresponding to the Regulation in its original form) shall indicate the series of amendments incorporating the most recent [major] technical amendment made to the Regulation at the time of issue of the approval. The same Contracting Party shall not assign the same number to another type of vehicle or component as defined in this Regulation.
- 4.3. Notice of approval or of extension of approval of a type pursuant to this Regulation shall be communicated to the Contracting Parties to the Agreement applying this Regulation by means of a form conforming to the model in Annex 2, Part 1, 2 or 3 as appropriate to this Regulation.
- 4.4. There shall be affixed, conspicuously and in a readily accessible place specified on the approval form, to every vehicle or component conforming to a type approved under this Regulation, an international approval mark consisting of:

- 4.4.1. a circle surrounding the letter "E" followed by the distinguishing number of the country which has granted approval 4/, and
- 4.4.2. the number of this Regulation, followed by the letter "R", a dash and the approval number, to the right of the circle prescribed in paragraph 4.4.1., and
- 4.4.3. an additional symbol:
 - 4.4.3.1. "A" in the case of an alarm system (Part II);
 - 4.4.3.2. "I" in the case of an immobilizer (Part IV);
 - 4.4.3.3. "AI" in the case of a combination of an alarm system and an immobilizer;
 - 4.4.3.4. "L" in the case of a vehicle approval as regards its devices to prevent unauthorized use (Part I);
 - 4.4.3.5. "LA" in the case of a vehicle approval as regards its devices to prevent unauthorized use (Part I) combined with an alarm system;
 - 4.4.3.6. "LI" in the case of a vehicle approval as regards its devices to prevent unauthorized use (Part I) combined with an immobilizer;
 - 4.4.3.7. "LAI" in the case of a vehicle approval as regards its devices to prevent unauthorized use (Part I) combined with an alarm system and an immobilizer.

4/ 1 for Germany, 2 for France, 3 for Italy, 4 for the Netherlands, 5 for Sweden, 6 for Belgium, 7 for Hungary, 8 for the Czech Republic, 9 for Spain, 10 for Serbia and Montenegro, 11 for the United Kingdom, 12 for Austria, 13 for Luxembourg, 14 for Switzerland, 15 (vacant), 16 for Norway, 17 for Finland, 18 for Denmark, 19 for Romania, 20 for Poland, 21 for Portugal, 22 for the Russian Federation, 23 for Greece, 24 for Ireland, 25 for Croatia, 26 for Slovenia, 27 for Slovakia, 28 for Belarus, 29 for Estonia, 30 (vacant), 31 for Bosnia and Herzegovina, 32 for Latvia, 33 (vacant), 34 for Bulgaria, 35 (vacant), 36 for Lithuania, 37 for Turkey, 38 (vacant), 39 for Azerbaijan, 40 for The former Yugoslav Republic of Macedonia, 41 (vacant), 42 for the European Community (Approvals are granted by its Member States using their respective ECE symbol), 43 for Japan, 44 (vacant), 45 for Australia, 46 for Ukraine, 47 for South Africa, 48 for New Zealand, 49 for Cyprus, 50 for Malta and 51 for the Republic of Korea. Subsequent numbers shall be assigned to other countries in the chronological order in which they ratify or accede to the Agreement Concerning the Adoption of Uniform Technical Prescriptions for Wheeled Vehicles, Equipment and Parts which can be Fitted and/or be Used on Wheeled Vehicles and the Conditions for Reciprocal Recognition of Approvals Granted on the Basis of these Prescriptions, and the numbers thus assigned shall be communicated by the Secretary-General of the United Nations to the Contracting Parties to the Agreement.

- 4.5. If a type conforms to a type approved, under one or more other Regulations annexed to the Agreement, in the country which has granted approval under this Regulation, the symbol prescribed in paragraph 4.4.1. need not be repeated; in such a case, the Regulation under which approval has been granted in the country which has granted approval under this Regulation shall be placed in vertical columns to the right of the symbol prescribed in paragraph 4.4.1.
- 4.6. The approval mark shall be clearly legible and be indelible.
- 4.7. In the case of a vehicle, the approval mark shall be placed close to or on the vehicle data plate affixed by the manufacturer.
- 4.8. In the case of a component approved separately as an alarm system or immobilizer or both, the approval mark shall be affixed by the manufacturer to the major element(s) of the device.
- 4.9. Annex 3 to this Regulation gives examples of arrangements of approval marks.
- 4.10. As an alternative to the approval mark described in paragraph 4.4. above, a certificate of conformity shall be issued for every VAS and immobilizer offered for sale.

Where a VAS and/or immobilizer manufacturer supplies an approved unmarked VAS and/or immobilizer to a vehicle manufacturer, for fitment by that manufacturer as original equipment for a vehicle model or range of vehicle models, the VAS and/or immobilizer manufacturer shall supply a number of copies of the certificate of conformity to the vehicle manufacturer, sufficient for that manufacturer to obtain the vehicle approval to Parts II, IV and V, as appropriate, of this Regulation.

If the VAS or immobilizer is made up of separate components, its main component(s) shall bear a reference mark and the certificate of conformity shall provide a list of such reference marks.

A model of the certificate of conformity is given in Annex 6 to this Regulation.

5. PART I: APPROVAL OF A VEHICLE OF CATEGORY M1 AND N1 WITH REGARD TO ITS DEVICES TO PREVENT UNAUTHORIZED USE
- 5.1. DEFINITIONS
- For the purpose of Part I of this Regulation,
- 5.1.1. "Vehicle type" means a category of motor vehicles which do not differ in such essential respects as:

- 5.1.1.1. the manufacturer's type designation,
- 5.1.1.2. the arrangement and design of the vehicle component or components on which the device to prevent unauthorized use acts,
- 5.1.1.3. the type of device to prevent unauthorized use.
- 5.1.2. "Device to prevent unauthorized use" means a system designed to prevent unauthorized normal activation of the engine or other source of main engine power of the vehicle in combination with at least one system which:
- (a) locks the steering,
 - (b) locks the transmission, or
 - (c) locks the gearshift control.
- 5.1.3. "Steering" means the steering control, the steering column and its accessory cladding, the steering shaft, the steering gearbox and all other components which directly affect the effectiveness of the device to prevent unauthorized use.
- 5.1.4. "Combination" means one of the specifically developed and constructed variations of a locking system which, when properly activated, permits operation of the locking system.
- 5.1.5. "Key" means any device designed and constructed to provide a method of operating a locking system which is designed and constructed to be operated only by that device.
- 5.1.6. "Rolling code" means an electronic code consisting of several elements the combination of which changes at random after each operation of the transmitting unit.
- 5.2. GENERAL SPECIFICATIONS
- 5.2.1. The device to prevent unauthorized use shall be so designed that it is necessary to put it out of action in order to enable:
- 5.2.1.1. the engine to be started by means of the normal control, and
 - 5.2.1.2. the vehicle to be steered, driven or moved forward under its own power.
 - 5.2.1.3. The requirement of paragraph 5.2.1. can be achieved at the same time as or before to the actions described at paragraphs 5.2.1.1. and 5.2.1.2.
- 5.2.2. The requirements of paragraph 5.2.1. shall be met by the application of a single key.

- 5.2.3. Except in the case provided for in paragraph 5.3.1.5., a system operated with a key inserted in a lock shall not permit removal of the key before the device referred to in paragraph 5.2.1. has come into action or has been set to act.
- 5.2.4. The device to prevent unauthorized use referred to in paragraph 5.2.1. above, and the vehicle components on which it operates, shall be so designed that it cannot rapidly and without attracting attention be opened, rendered ineffective or destroyed by, for example, the use of low-cost, easily concealed tools, equipment or fabrications readily available to the public at large.
- 5.2.5. The device to prevent unauthorized use shall be fitted to the vehicle as an item of original equipment (i.e. equipment installed by the vehicle manufacturer prior to first retail sale). It shall be fitted in such a way that even after removal of its housing it cannot, when in the blocked condition, be dismantled otherwise than with special tools. If it is possible to render the device to prevent unauthorized use ineffective by the removal of screws, those screws shall, unless they are of the non-removable type, be covered by parts of the blocked protective device.
- 5.2.6. Mechanical locking systems shall provide at least 1,000 different key combinations or a number equal to the total number of vehicles manufactured annually if less than 1,000. In vehicles of one type the frequency of occurrence of each combination shall be roughly one per 1,000.
- 5.2.7. Electrical/electronic locking systems, e.g. remote control, shall have at least 50,000 variants and shall incorporate a rolling code and/or have a minimum scan time of ten days, e.g. a maximum of 5,000 variants per 24 hours for 50,000 variants minimum.
- 5.2.8. Regarding the nature of the device to prevent the unauthorized use, paragraph 5.2.6. or 5.2.7., shall be applied.
- 5.2.9. The key and lock shall not be visibly coded.
- 5.2.10. The lock shall be so designed, constructed and fitted that turning of the lock cylinder, when in the locked position, with a torque of less than 2.45 Nm is not possible with any key other than the mating key, and
- 5.2.10.1. for lock cylinders with pin tumblers no more than two identical tumblers operating in the same direction shall be positioned adjacent to each other, and in a lock there shall not be more than 60 per cent identical tumblers;
- 5.2.10.2. for lock cylinders with disc tumblers no more than two identical tumblers operating in the same direction shall be positioned adjacent to each other, and in a lock there shall not be more than 50 per cent identical tumblers.

- 5.2.11. Devices to prevent unauthorized use shall be such as to exclude any risk of accidental operating failure while the engine is running, particularly in the case of blockage likely to compromise safety.
- 5.2.11.1. It shall not be possible to activate devices to prevent unauthorized use without first setting the engine controls to a stop condition and then performing an action which is not an uninterrupted continuation of stopping the engine or without first setting the engine controls to a stop condition and when the vehicle is stationary with the parking brake applied or the speed of the vehicle does not exceed 4 km/h.
- 5.2.11.2. In the case of devices to prevent unauthorized use, if the action of key withdrawal activates the device it shall either necessitate a minimum movement of 2 mm before activation of the device or incorporate an override facility to prevent accidental removal or partial withdrawal of the key.
- 5.2.11.3. Paragraphs 5.2.10., 5.2.10.1. or 5.2.10.2., and 5.2.11.2. are only applicable to devices which include mechanical keys.
- 5.2.12. Power assistance may be used only to activate the locking and/or unlocking action of the device to prevent unauthorized use. The device shall be kept in its operating position by any suitable means which does not need a power supply.
- 5.2.13. It shall not be possible to activate the motive power of the vehicle by normal means until the device to prevent unauthorized use has been deactivated.
- 5.2.14. Devices to prevent unauthorized use preventing release of the brakes of the vehicle shall not be permitted.
- 5.2.15. If the device to prevent unauthorized use is equipped with a driver warning feature it shall be activated when the operator opens the driver's side door, unless the device has been activated and the key removed by the operator.

5.3. PARTICULAR SPECIFICATIONS

In addition to the general specifications prescribed in paragraph 5.2, the device to prevent unauthorized use shall meet the particular conditions prescribed below:

5.3.1. Devices to prevent unauthorized use acting on the steering

- 5.3.1.1. A device to prevent unauthorized use acting on the steering shall render the steering inoperative. Before the engine can be started, the normal steering operation must be restored.

- 5.3.1.2. When the device to prevent unauthorized use is set to act, it shall not be possible to prevent the device from functioning.
- 5.3.1.3. The device to prevent unauthorized use must continue to meet the requirements of paragraphs 5.2.11., 5.3.1.1., 5.3.1.2. and 5.3.1.4. after it has undergone 2,500 locking cycles in each direction of the wear producing test specified in Part 1 of Annex 4 to this Regulation.
- 5.3.1.4. The device to prevent unauthorized use shall, in its activated position, satisfy one of the following criteria:
- 5.3.1.4.1. It shall be strong enough to withstand, without damage to the steering mechanism likely to compromise safety, the application of a torque of 300 Nm about the axis of the steering spindle in both directions under static conditions.
- 5.3.1.4.2. It shall incorporate a mechanism designed to yield or slip, such that the system will withstand, either continuously or intermittently, the application of a torque of at least 100 Nm. The locking system must still withstand the application of this torque after the test specified in Part 2 of Annex 4 to this Regulation.
- 5.3.1.4.3. It shall incorporate a mechanism designed to permit the steering wheel to rotate freely on the blocked steering spindle. The blocking mechanism shall be strong enough to withstand the application of a torque of 200 Nm about the axis of the steering spindle in both directions under static conditions.
- 5.3.1.5. If the device to prevent unauthorized use is such that the key can be removed in a position other than the position in which the steering is inoperative, it shall be so designed that the manoeuvre required to reach that position and remove the key cannot be effected inadvertently.
- 5.3.1.6. If a component fails such that the torque requirements specified in paragraphs 5.3.1.4.1., 5.3.1.4.2. and 5.3.1.4.3. cannot be easily applied, yet the steering system remains blocked, the system shall satisfy the requirements.
- 5.3.2. Devices to prevent unauthorized use acting on the transmission
- 5.3.2.1. A device to prevent unauthorized use acting on the transmission shall prevent the rotation of the vehicle's driving wheels.
- 5.3.2.2. When the device to prevent unauthorized use is set to act, it shall not be possible to prevent the device from functioning.
- 5.3.2.3. It shall not be possible for the transmission to be blocked inadvertently when the key is in the lock of the device to prevent unauthorized use, even if the device preventing starting of the engine has come into action or been set to act.

- 5.3.2.4. The device to prevent unauthorized use shall be so designed and constructed that it remains fully effective even after some degree of wear as a result of 2,500 locking cycles in each direction.
- 5.3.2.5. If the device to prevent unauthorized use is such that the key can be removed in a position other than the position in which the transmission is locked, it shall be so designed that the manoeuvre required to reach that position and remove the key cannot be effected inadvertently.
- 5.3.2.6. The device to prevent unauthorized use shall be strong enough to withstand, without damage likely to compromise safety, the application in both directions and in static conditions of a torque 50 per cent greater than the maximum torque that can normally be applied to the transmission. In determining the level of this testing torque account shall be taken not of the maximum engine torque, but of the maximum torque that can be transmitted by the clutch or by the automatic transmission.
- 5.3.3. Devices to prevent unauthorized use acting on the gearshift control
- 5.3.3.1. A device to prevent unauthorized use acting on the gearshift control shall be capable of preventing any change of gear.
- 5.3.3.2. In the case of manual gearboxes it must be possible to lock the gearshift lever in reverse only; in addition locking in neutral shall be permitted.
- 5.3.3.3. In the case of automatic gearboxes provided with a "parking" position it must be possible to lock the mechanism in the parking position only; in addition locking in neutral and/or reverse shall be permitted.
- 5.3.3.4. In the case of automatic gearboxes not provided with a "parking" position it must be possible to lock the mechanism in the following positions only: neutral and/or reverse.
- 5.3.3.5. The device to prevent unauthorized use shall be so designed and constructed that it remains fully effective even after some degree of wear as a result of 2,500 locking cycles in each direction.

5.4. ELECTROMECHANICAL AND ELECTRONIC DEVICES TO PREVENT UNAUTHORIZED USE

Electromechanical and electronic devices to prevent unauthorized use, where fitted, shall comply with the requirements of paragraphs 5.2. and 5.3. above and paragraph 8.4. below, mutatis mutandi.

If the technology of the device is such that paragraphs 5., 6., and 8.4. are not applicable it shall be verified that care has been taken to preserve safety of the

vehicle. The functioning process of these devices shall incorporate secure means to prevent any risk of blocking or accidental disfunctioning which could compromise the safety of the vehicle.

6. PART II: APPROVAL OF VEHICLE ALARM SYSTEMS

6.1. DEFINITIONS

For the purpose of Part III of this Regulation,

- 6.1.2. "Vehicle alarm system" (VAS) means a system intended for installation on (a) type(s) of vehicle(s), designed to indicate intrusion into or interference with the vehicle; these systems may provide additional protection against unauthorized use of the vehicle.
- 6.1.3. "Sensor" means a device which senses a change which could be caused by intrusion into or interference with a vehicle.
- 6.1.4. "Warning device" means a device indicating that intrusion into or interference has occurred.
- 6.1.5. "Control equipment" means equipment necessary for the setting, unsetting and testing of a VAS and for sending an alarm condition to warning devices.
- 6.1.6. "Set" means the state of a VAS in which an alarm condition can be transmitted to warning devices.
- 6.1.7. "Unset" means the state of a VAS in which an alarm condition cannot be transmitted to warning devices.
- 6.1.8. "Key" means any device designed and constructed to provide a method of operating a locking system which is designed and constructed to be operated only by that device.
- 6.1.9. "Type of vehicle alarm system" means systems which do not differ significantly in such essential aspects as:
- (a) the manufacturer's trade name or mark,
 - (b) the kind of sensor,
 - (c) the kind of warning device,
 - (d) the kind of control equipment.
- 6.1.10. "Approval of a vehicle alarm system" means the approval of a type of VAS with respect to the requirements laid down in paragraphs 6.2., 6.3. and 6.4. below.

6.1.11. "Immobilizer" means a device which is intended to prevent the vehicle being driven away powered by its own engine.

6.1.12. "Panic alarm" means a device which enables a person to use an alarm, installed on the vehicle, to summon assistance in an emergency.

6.2. GENERAL SPECIFICATIONS

6.2.1. VAS shall, in the event of intrusion into or interference with a vehicle, provide a warning signal. The warning signal shall be audible and in addition may include optical warning devices, or be a radio alarm or any combination of the above.

6.2.2. VASs shall be designed, constructed and installed in such a way that the vehicle when equipped shall continue to comply with the relevant technical requirements, especially with regard to electromagnetic compatibility (EMC).

6.2.3. If the VAS includes the possibility of a radio transmission, e.g. for setting or unsetting of the alarm or for alarm transmission, it shall comply with the relevant ETSI Standards 5/, e.g. EN 300 220-1 V1.3.1. (2000-09), EN 300 220-2 V1.3.1. (2000-09), EN 300 220-3 V1.1.1. (2000-09) and EN 301 489-3 V1.2.1. (2000-08) (including any advisory requirements). The frequency and maximum radiated power of radio transmissions for the setting and unsetting of the alarm system must comply with the CEPT/ERC 6/ Recommendation 70-03 (17 February 2000) relating to the use of short range devices. 7/

6.2.4. The installation of a VAS in a vehicle shall not be capable of influencing the vehicle's performance (in the unset state), or its safe operation.

6.2.5. The VAS and components thereof shall not activate inadvertently, particularly whilst the engine is in its running mode.

6.2.6. Failure of the VAS, or failure of its electrical supply shall not affect the safe operation of the vehicle.

5/ ETSI: European Telecommunications Standards Institute. If these Standards are not available when this Regulation comes into force, then the relevant domestic requirements shall apply.

6/ CEPT: Conference of European Posts and Telecommunications
ERC: European Radiocommunications Committee

7/ Contracting Parties may prohibit the frequency and/or the power and may permit the use of other frequency and/or power.

- 6.2.7. The VAS, its components and the parts controlled by them shall be designed, built and installed in such a way as to minimize the risk for anyone to make them inoperable or to destroy them rapidly and without calling attention, e.g. using low-cost, easily-concealed tools, equipment or fabrications readily available to the public at large.
- 6.2.8. The means of setting and unsetting of the VAS shall be designed in such a way that it does not invalidate the requirements of Part I above. Electrical connections to components covered by Part I of this Regulation are allowed.
- 6.2.9. The system shall be so arranged that the shorting out of any warning signal circuit shall not render inoperative any aspects of the alarm system, other than the circuit which is shorted out.
- 6.2.10. VAS may include an immobilizer which shall comply with the requirements of Part IV of this Regulation.

6.3. PARTICULAR SPECIFICATIONS

6.3.1. Protection range

6.3.1.1. Specific requirements

The VAS shall at least detect and signal the opening of any vehicle door, engine bonnet and luggage compartment. The failure or switching off of light sources, e.g. passenger compartment light, shall not impair the control operation.

Additional efficient sensors for information/display, e.g.:

- (i) of intrusions into the vehicle, e.g. passenger compartment control, window glass control, breakage of any glazed area, or
- (ii) of attempted vehicle theft, e.g. inclination sensor

are allowed, taking account of measures to prevent any unnecessary sounding of the alarm (= false alarm, see paragraph 6.3.1.2. below).

Insofar as these additional sensors generate an alarm signal even after an intrusion has occurred (e.g. by breakage of a glazed area) or under external influences (e.g. wind), the alarm signal, activated by one of the above-mentioned sensors, shall be activated not more than 10 times within the same activation period of the VAS.

In this case the activation period shall be limited by the authorized unsetting of the system as a result of the vehicle user's action.

Some kinds of additional sensors, e.g. passenger compartment control (ultrasonic, infrared) or inclination sensor, etc., may be intentionally deactivated. In this case, separate deliberate action must be taken each time before the VAS is set. It must not be possible to deactivate the sensors while the alarm system is in a set state.

6.3.1.2. Safety against false alarm

6.3.1.2.1. By adequate measures, e.g.

- (i) mechanical design and design of the electrical circuit according to conditions specific to motor vehicles,
- (ii) selection and application of operation and control principles for the alarm system and components thereof,

it shall be ensured that the VAS both in set and unset conditions, cannot cause the alarm signal to sound unnecessarily, in the event of:

- (a) an impact on the vehicle: test specified in paragraph 6.4.2.13.,
- (b) electromagnetic compatibility: tests specified in paragraph 6.4.2.12.,
- (c) reduction of battery voltage by continuous discharge: test specified in paragraph 6.4.2.14.,
- (d) false alarm of the passenger compartment control: test specified in paragraph 6.4.2.15.

6.3.1.2.2. If the applicant for approval can demonstrate, e.g. by technical data, that safety against false alarm is satisfactorily ensured, the technical service responsible for conducting approval tests may not require some of the above tests.

6.3.2. Audible alarm

6.3.2.1. General

The warning signal shall be clearly audible and recognizable and shall differ significantly from the other audible signals used in road traffic.

In addition to the original equipment audible warning device, a separate audible warning device may be fitted in the area of the vehicle which is controlled by the VAS, where it shall be protected against easy, rapid access by persons.

If a separate audible warning device according to paragraph 6.3.2.3.1. below is used, the original equipment standard audible warning device may additionally

be actuated by the VAS, provided that any tampering with the standard audible warning device (generally more easily accessible) does not affect the operation of the additional audible warning device.

6.3.2.2. Duration of the audible signal

Minimum: 25 s
Maximum: 30 s

The audible signal may sound again only after the next interference with the vehicle, i.e. after the above-mentioned time span (Restrictions: see paragraphs 6.3.1.1. and 6.3.1.2. above).

Unsetting of the alarm system shall immediately cut the signal.

6.3.2.3. Specifications concerning the audible signal

6.3.2.3.1. Constant tone signal device (constant frequency spectrum), e.g. horns: acoustical, etc., data according to ECE Regulation No. 28, Part I.

Intermittent signal (on/off):
Trigger frequency (2 " 1) Hz
On time = off time \pm 10%

6.3.2.3.2. Audible signal device with frequency modulation: acoustical, etc., data according to ECE Regulation No. 28, Part I but equal passage of a significant frequency range within the above-mentioned range (1,800 through 3,550 Hz) in both directions.

Passage frequency (2 " 1) Hz

6.3.2.3.3. Sound level

The sound source shall be:

- (i) either an audible warning device approved under ECE Regulation No. 28, Part I
- (ii) or a device meeting the requirements of ECE Regulation No. 28, Part I, paragraphs 6.1. and 6.2.

However, in the case of a different sound source from the original equipment audible warning device, the minimum sound level may be reduced to 100 dB(A), measured under the conditions of ECE Regulation No. 28, Part I.

6.3.3. Optical alarm - if fitted

6.3.3.1. General

In the event of intrusion into or interference with the vehicle, the device shall activate an optical signal as specified in paragraphs 6.3.3.2. and 6.3.3.3. below.

6.3.3.2. Duration of the optical signal

The optical signal shall have a duration between 25 s and 5 min after the alarm has been activated. The unsetting of the alarm system shall immediately stop the signal.

6.3.3.3. Type of optical signal

Flashing of all direction indicators and/or passenger compartment light of the vehicle, including all lamps in the same electrical circuit.

Trigger frequency (2 " 1) Hz

In relation to the audible signal, also asynchronous signals are allowed.

On time = off time " 10 per cent

6.3.4. Radio alarm (pager) - if fitted

The VAS may include a facility generating an alarm signal by radio transmission.

6.3.5. Alarm system setting lock

6.3.5.1. When the engine is in its running mode, deliberate or inadvertent setting of the alarm system shall be impossible.

6.3.6. Setting and unsetting of the VAS

6.3.6.1. Setting

Any suitable means of setting of the VAS is allowed, provided that such means does not inadvertently cause false alarms.

6.3.6.2. Unsetting

Unsetting of the VAS shall be achieved by one or a combination of the following devices. Other devices giving an equivalent performance are permitted.

- 6.3.6.2.1. A mechanical key (complying with the requirements of Annex 10 to this Regulation) which can be coupled with a centralized vehicle locking system comprising at least 1,000 variants, operated from the outside.
- 6.3.6.2.2. Electrical/electronic device, e.g. remote control, with at least 50,000 variants and shall incorporate rolling codes and/or have a minimum scan time of ten days, e.g. a maximum of 5,000 variants per 24 hours for 50,000 variants minimum.
- 6.3.6.2.3. A mechanical key or an electrical/electronic device within the protected passenger compartment, with timed exit/entry delay.

6.3.7. Exit delay

If the switching device for setting the VAS is fitted within the protected area, an exit delay shall be provided. It shall be possible for the exit delay to be set to between 15 seconds and 45 seconds after the switch has been operated. The delay period may be adjustable to suit individual operators' circumstances.

6.3.8. Entry delay

If the device for unsetting the VAS is fitted within the protected area, a delay of 5 seconds minimum and 15 seconds maximum shall be allowed before the activation of the audible and optical signals. The delay period may be adjustable to suit individual operators' circumstances.

6.3.9. Status display

6.3.9.1. To provide information on the status of the VAS (set, unset, alarm setting period, alarm has been activated), optical displays inside and outside the passenger compartment are allowed. The light intensity of optical signals installed outside the passenger compartment shall not exceed 0.5 cd.

6.3.9.2. If an indication of short-term "dynamic" processes such as changes from "set" to "unset" and vice versa is provided, it shall be optical, according to paragraph 6.3.9.1. Such optical indication may also be produced by the simultaneous operation of the direction indicators and/or passenger compartment lamp(s), provided that the duration of the optical indication by the direction indicators does not exceed 3 seconds.

6.3.10. Power supply

The source of power for the VAS may be the vehicle battery. Where provided, an additional battery shall be rechargeable and it shall by no means supply energy to the other parts of the vehicle electrical system.

6.3.11. Specifications for optional functions

6.3.11.1. Self check, automatic failure indication

On setting the VAS, irregular situations, e.g. open doors, etc., can be detected by a self-check function (plausibility control), and this situation is indicated.

6.3.11.2. Panic alarm

An optical and/or audible and/or radio alarm is allowed independent of the state (set or unset) and/or function of the VAS. Such an alarm shall be triggered from within the vehicle and shall not affect the state (set or unset) of the VAS. Also it must be possible for the vehicle user to switch off the panic alarm. In the case of an audible alarm, its sounding duration per activation shall not be restricted. A panic alarm shall not immobilize the engine or stop it if it is running.

6.4. OPERATION PARAMETERS AND TEST CONDITIONS 8/

6.4.1. Operation parameters

All components of the VAS shall operate without any failure under the following conditions.

6.4.1.1. Climatic conditions

Two classes of environmental temperature are defined as follows:

- (a) -40°C to +85°C for parts to be fitted in the passenger or luggage compartment,
- (b) -40°C to +125°C for parts to be fitted in the engine compartment unless otherwise specified.

6.4.1.2. Degree of protection for installation

The following degrees of protection in accordance with IEC Publication 529-1989 shall be provided:

- (i) IP 40 for parts to be fitted in the passenger compartment,

8/ Lamps which are used as part of the optical warning devices and which are included in the standard car lighting system need not comply with the operation parameters in paragraph 6.4.1. and shall not be submitted to tests listed under paragraph 6.4.2.

- (ii) IP 42 for parts to be fitted in the passenger compartment of roadsters/convertibles and cars with moveable roof-panels if the installation location requires a higher degree of protection than IP 40,
- (iii) IP 54 for all other parts.

The VAS manufacturer shall specify in the installation instructions any restrictions on the positioning of any part of the installation with respect to dust, water and temperature.

6.4.1.3. Weatherability

7 days according to IEC 68-2-30-1980.

6.4.1.4. Electrical conditions

Rated supply voltage: 12 V

Operation supply voltage range: from 9 V to 15 V in the temperature range according to paragraph 6.4.1.1.

Time allowance for excess voltages at 23°C:

U = 18 V, max. 1 h

U = 24 V, max. 1 min.

6.4.2. Test conditions

6.4.2.1. Operation tests

6.4.2.1.1. Compliance of the VAS with the following specifications shall be checked:

Alarm duration according to paragraphs 6.3.2.2. and 6.3.3.2;

Frequency and on/off ratio according to paragraphs 6.3.3.3. and 6.3.2.3.1. or 6.3.2.3.2. respectively;

Number of alarm cycles according to paragraph 6.3.1.1., if applicable;

Alarm system setting lock check according to paragraph 6.3.5.

6.4.2.1.2. Normal test conditions

Voltage U = (12 " 0.2) V

Temperature..... T = (23 " 5)°C

6.4.2.2. Resistance to temperature and voltage changes

Compliance with the specifications defined under paragraph 6.4.2.1.1. shall also be checked under the following conditions:

6.4.2.2.1. Test temperature.....T (-40 " 2)°C
 Test voltageU = (9 " 0.2) V
 Storage duration 4 hours

6.4.2.2.2. For parts to be fitted in the passenger or luggage compartment:
 Test temperature.....T = (+85 " 2)°C
 Test voltageU = (15 " 0.2) V
 Storage duration 4 hours

6.4.2.2.3. For parts to be fitted in the engine compartment unless otherwise specified:
 Test temperature.....T = (+125 " 2)°C
 Test voltageU = (15 " 0.2) V
 Storage duration 4 hours

6.4.2.2.4. The VAS, in both set and unset state, shall be submitted to an excess voltage equal to (18 " 0.2) V for 1 hour.

6.4.2.2.5. The VAS, in both set and unset state, shall be submitted to an excess voltage equal to (24 " 0.2) V for 1 min.

6.4.2.3. Safe operation after foreign body and water-tightness testing

After the test for tightness to foreign body and water according to IEC 529-1989, for degrees of protection as in paragraph 6.4.1.2., the operation tests according to paragraph 6.4.2.1. shall be repeated.

6.4.2.4. Safe operation after condensed water test

After a resistance-to-humidity test to be carried out according to IEC 68-2-30 (1980) the operation tests according to paragraph 6.4.2.1. shall be repeated.

6.4.2.5. Test for safety against reversed polarity

The VAS and components thereof shall not be destroyed by reversed polarity up to 13 V during 2 min. After this test the operation tests according to paragraph 6.4.2.1. shall be repeated with fuses changed, if necessary.

6.4.2.6. Test for safety against short-circuits

All electrical connections of the VAS must be short-circuit proof against earth, max. 13 V and/or fused. After this test the operation tests according to paragraph 6.4.2.1. shall be repeated, with fuses changed if necessary.

6.4.2.7. Energy consumption in the set condition

The energy consumption in set condition under the conditions given in paragraph 6.4.2.1.2. shall not exceed 20 mA on average for the complete alarm system including status display.

6.4.2.8. Safe operation after vibration test

6.4.2.8.1. For this test, the components are subdivided into two types:

Type 1: components normally mounted on the vehicle,
Type 2: components intended for attachment to the engine.

6.4.2.8.2. The components/VAS shall be submitted to a sinusoidal vibration mode whose characteristics are as follows:

6.4.2.8.2.1. For type 1

The frequency shall be variable from 10 Hz to 500 Hz with a maximum amplitude of " 5 mm and maximum acceleration of 3 g (0-peak).

6.4.2.8.2.2. For type 2

The frequency shall be variable from 20 Hz to 300 Hz with a maximum amplitude of " 12 mm and maximum acceleration of 15 g (0-peak).

6.4.2.8.2.3. For both type 1 and type 2

The frequency variation is 1 octave/min.

The number of cycle is 10, the test shall be performed along each of the 3 axes.

The vibrations are applied at low frequencies at a maximum constant amplitude and at a maximum constant acceleration at high frequencies.

6.4.2.8.3. During the test the VAS shall be electrically connected and the cable shall be supported after 200 mm.

6.4.2.8.4. After the vibration test the operation tests according to paragraph 6.4.2.1. shall be repeated.

6.4.2.9. Durability test

Under the test conditions specified in paragraph 6.4.2.1.2., triggering of 300 complete alarm cycles (audible and/or optical) with a rest time of the audible device of 5 min.

6.4.2.10. Tests for external key switch (installed on the outside of the vehicle)

The following tests shall only be performed if the locking cylinder of the original equipment door lock is not used.

6.4.2.10.1. The key switch shall be so designed and constructed that it remains fully effective even after 2,500 set/unset cycles in each direction, followed by 96 hours minimum of exposure to salt spray test according to IEC 68-2-11-1981, corrosion resistance test.

6.4.2.11. Test of systems for the protection of the passenger compartment

The alarm shall be activated, when a vertical panel of 0.2 x 0.15 m is inserted for 0.3 m (measured from the centre of the vertical plane) through an open front door window into the passenger compartment, towards the front and parallel to the road at a speed of 0.4 m/s and at an angle of 45° with the longitudinal median plane of the vehicle. (See drawings in Annex 8 to this Regulation).

6.4.2.12. Electromagnetic compatibility

The VAS shall be submitted to the tests described in Annex 9.

6.4.2.13. Safety against false alarm in the event of an impact on the vehicle

It shall be verified that an impact of up to 4.5 Joules of a hemispherical body with 165 mm in diameter and 70 " 10 Shore A applied anywhere to the vehicle bodywork or glazing with its curved surface does not cause false alarms.

6.4.2.14. Safety against false alarm in the event of a voltage reduction

It shall be verified that slow reduction of the main battery voltage by continuous discharge of 0.5 V per hour down to 3 V does not cause false alarms.

Test conditions : see paragraph 6.4.2.1.2. above.

6.4.2.15. Test for safety against false alarm of the passenger compartment control

Systems intended for the protection of the passenger compartment according to paragraph 6.3.1.1. above shall be tested together with a vehicle under normal conditions (paragraph 6.4.2.1.2.).

The system, installed according to the manufacturer's instructions, shall not be triggered when subjected 5 times to the test described in paragraph 6.4.2.13. above at intervals of 0.5 s.

The presence of a person touching or moving around the outside of the vehicle (windows closed) shall not cause any false alarm.

6.5. INSTRUCTIONS

Each VAS shall be accompanied by:

6.5.1. Instructions for installation:

6.5.1.1. The list of vehicles and vehicle models for which the device is intended. This list may be specific or generic, e.g. "all cars with petrol engines and 12 V negative earth batteries".

6.5.1.2. The method of installation illustrated by photographs and/or very clear drawings.

6.5.1.3. In the case of VAS which includes an immobilizer, additional instructions regarding compliance with the requirements of Part IV of this Regulation.

6.5.2. A blank installation certificate, an example of which is given in Annex 7.

6.5.3. A general statement to the VAS purchaser calling his attention to the following points:

the VAS should be installed in accordance with the manufacturer's instructions; the selection of a good installer is recommended (the VAS manufacturer may be contacted to indicate appropriate installers);

the installation certificate supplied with the VAS should be completed by the installer.

6.5.4. Instruction for use.

6.5.5. Instruction for maintenance.

- 6.5.6. A general warning regarding the danger of making any alterations or additions to the system; such alterations or additions would automatically invalidate the certificate of installation referred to in paragraph 6.5.2. above.
- 6.5.7. Indication of the location(s) of the international approval mark mentioned in paragraph 4.4. of this Regulation and/or the international certificate of conformity mentioned in paragraph 4.10. of this Regulation.

7. PART III: APPROVAL OF A VEHICLE WITH REGARD TO ITS ALARM SYSTEM

When a VAS approved to Part III of this Regulation is being used in a vehicle submitted for approval to Part IV of this Regulation, tests required to be passed by a VAS in order to obtain approval to Part III of this Regulation shall not be repeated.

7.1. DEFINITIONS

For the purpose of Part III of this Regulation,

- 7.1.1. "Alarm system(s)" (AS) means an arrangement of components fitted as original equipment in a vehicle type, designed to indicate intrusion into or interference with the vehicle; these systems may provide additional protection against unauthorized use of the vehicle.
- 7.1.2. "Vehicle type with regard to its alarm system" means vehicles which do not differ significantly in such essential aspects as:
- (a) the manufacturer's trade name or mark,
 - (b) vehicle features which significantly influence the performances of the AS,
 - (c) the type and design of the AS or VAS.
- 7.1.3. "Approval of a vehicle" means the approval of a vehicle type with regard to the requirements laid down in paragraphs 7.2., 7.3. and 7.4. below.
- 7.1.4. Other definitions applicable to Part III are contained in paragraph 6.1. of this Regulation.

7.2. GENERAL SPECIFICATIONS

- 7.2.1. ASs shall be designed and built in such a way that they, in the event of intrusion into or interference with a vehicle, provide a warning signal, and may include an immobilizer.

The warning signal shall be audible and in addition may include optical warning devices, or be a radio alarm, or any combination of the above.

- 7.2.2. Vehicle which are equipped with alarm systems shall comply with the relevant technical requirements, especially with regard to electromagnetic compatibility (EMC).
- 7.2.3. If the AS includes the possibility of a radio transmission, e.g. for setting or unsetting of the alarm or for alarm transmission, it shall comply with the relevant ETSI Standards (see footnote 5/ pertinent to paragraph 6.2.3.), e.g. EN 300 220-1 V1.3.1. (2000-09), EN 300 220-2 V1.3.1. (2000-09), EN 300 220-3 V1.1.1. (2000-09) and EN 301 489-3 V1.2.1. (2000-08) (including any advisory requirements). The frequency and maximum radiated power of radio transmissions for the setting and unsetting of the alarm system must comply with the CEPT/ERC (see footnote 6/ pertinent to paragraph 6.2.3.) Recommendation 70-03 (17 February 2000) relating to the use of short range devices (see footnote 7/ pertinent to paragraph 6.2.3.).
- 7.2.4. The AS and components thereof shall not activate inadvertently, particularly whilst the engine is in its running mode.
- 7.2.5. Failure of the AS, or failure of its electrical supply shall not affect the safe operation of the vehicle.
- 7.2.6. The alarm system, its components and the parts controlled by them shall be so installed as to minimize the risk for anyone to make them inoperable or to destroy them rapidly and without calling attention, e.g. using low-cost, easily-concealed tools, equipment or fabrications readily available to the public at large.
- 7.2.7. The system shall be so arranged that the shorting out of any warning signal circuit shall not render inoperative any aspects of the alarm system, other than the circuit which is shorted out.

7.3. PARTICULAR SPECIFICATIONS

7.3.1. Protection range

7.3.1.1. Specific requirements

The AS shall at least detect and signal the opening of any vehicle door, engine bonnet and luggage compartment. The failure or switching off of light sources, e.g. passenger compartment light, shall not impair the control operation.

The installation of additional efficient sensors for information/display, e.g.:

- (i) of intrusion into the vehicle, e.g. passenger compartment control, window glass control breakage of any glazed area, or
- (ii) of attempted vehicle theft, e.g. inclination sensor

are allowed, taking account of measures to prevent any unnecessary sounding of the alarm (= false alarm, see paragraph 7.3.1.2. below).

Insofar as these additional sensors generate an alarm signal even after an intrusion has occurred (e.g. by breakage of a glazed area) or under external influences (e.g. wind), the alarm signal, activated by one of the above-mentioned sensors, shall be activated not more than 10 times within the same activation period of the AS.

In this case the activation period shall be limited by the authorized unsetting of the system as a result of the vehicle user's action.

Some kinds of additional sensors, e.g. passenger compartment control (ultrasonic, infrared) or inclination sensor, etc., may be intentionally deactivated. In this case, separate deliberate action must be taken each time before the AS is set. It must not be possible to deactivate the sensors while the alarm system is in a set state.

7.3.1.2. Safety against false alarm

7.3.1.2.1. It shall be ensured that the AS both in set and unset conditions, cannot cause the alarm signal to sound unnecessarily, in the event of:

- (a) an impact on the vehicle: test specified in paragraph 6.4.2.13.,
- (b) electromagnetic compatibility: tests specified in paragraph 6.4.2.12.,
- (c) reduction of battery voltage by continuous discharge: test specified in paragraph 6.4.2.14.,
- (d) false alarm of the passenger compartment control: test specified in paragraph 6.4.2.15.

7.3.1.2.2. If the applicant for approval can demonstrate, e.g. by technical data, that safety against false alarm is satisfactorily ensured, the technical service responsible for conducting approval tests may not require some of the above tests.

7.3.2. Audible alarm

7.3.2.1. General

The warning signal shall be clearly audible and recognizable and shall differ significantly from the other audible signals used in road traffic.

In addition to the original equipment audible warning device, a separate audible warning device may be fitted in the area of the vehicle which is controlled by the AS, where it shall be protected against easy, rapid access by persons.

If a separate audible warning device according to paragraph 7.3.2.2. below is used, the original equipment standard audible warning device may additionally be actuated by the AS, provided that any tampering with the standard audible warning device (generally more accessible) does not affect the operation of the additional audible warning device.

7.3.2.2. Duration of the audible signal

Minimum: 25 s
Maximum: 30 s

The audible signal may sound again only after the next interference with the vehicle, i.e. after the above-mentioned time span. (Restrictions: see paragraphs 7.3.1.1. and 7.3.1.2. above).

Unsetting of the alarm system shall immediately cut the signal.

7.3.2.3. Specifications concerning the audible signal

7.3.2.3.1. Constant tone signal device (constant frequency spectrum), e.g. horns: acoustical, etc., data according to ECE Regulation No. 28, Part I.

Intermittent signal (on/off):
Trigger frequency (2 " 1) Hz
On time = off time " 10 per cent

7.3.2.3.2. Audible signal device with frequency modulation: acoustical, etc., data according to ECE Regulation No. 28, Part I but equal passage of a significant frequency range within the above-mentioned range (1,800 through 3,550 Hz) in both directions.

Passage frequency (2 " 1) Hz

7.3.2.3.3. Sound level

The sound level shall be:

- (i) either an audible warning device approved under ECE Regulation No. 28, Part I
- (ii) or a device meeting the requirements of ECE Regulation No. 28, Part I, paragraph 6.1. and 6.2.

However, in the case of a different sound source from the original equipment audible warning device, the minimum sound level may be reduced to 100 dB(A), measured under the conditions of ECE Regulation No. 28, Part I.

7.3.3. Optical alarm - if fitted

7.3.3.1. General

In the event of intrusion into or interference with the vehicle the device shall activate an optical signal as specified in paragraphs 7.3.3.2. and 7.3.3.3. below.

7.3.3.2. Duration of the optical signal

The optical signal shall have a duration between 25 s and 5 min after the alarm has been activated. The unsetting of the alarm system shall immediately stop the signal.

7.3.3.3. Type of optical signal

Flashing of all direction indicators and/or passenger compartment light of the vehicle, including all lamps in the same electrical circuit.

Trigger frequency (2 " 1) Hz

In relation to the audible signal, also asynchronous signals are allowed.

On time = off time " 10 per cent

7.3.4. Radio alarm (pager) - if fitted

The AS may include a facility generating an alarm signal by radio transmission.

7.3.5. Alarm system setting lock

7.3.5.1. When the engine is in its running mode, deliberate or inadvertent setting of the alarm system shall be impossible.

7.3.6. Setting and unsetting of the AS

7.3.6.1. Setting

Any suitable means of setting of the AS is allowed, provided that such means does not inadvertently cause false alarms.

7.3.6.2. Unsetting

Unsetting of the AS shall be achieved by one or a combination of the following devices. Other devices giving equivalent performance are permitted.

7.3.6.2.1. A mechanical key (complying with requirements of Annex 10 to this Regulation) which can be coupled with a centralized vehicle locking system comprising of at least 1,000 variants, operated from the outside.

7.3.6.2.2. Electrical/electronic device, e.g. remote control, with at least 50,000 variants and shall incorporate rolling codes and/or have a minimum scan time of ten days, e.g. a maximum of 5,000 variants per 24 hours for 50,000 variants minimum.

7.3.6.2.3. A mechanical key or an electrical/electronic device within the protected passenger compartment, with timed exit/entry delay.

7.3.7. Exit delay

If the switching device for setting the AS is fitted within the protected area, an exit delay shall be provided. It shall be possible for the exit delay to be set to between 15 seconds and 45 seconds after the switch has been operated. The delay period may be adjustable to suit individual operators' circumstances.

7.3.8. Entry delay

If the device for unsetting the VAS is fitted within the protected area, a delay of 5 seconds minimum and 15 seconds maximum shall be allowed before the activation of the audible and optical signals. The delay period may be adjustable to suit individual operators' circumstances.

7.3.9. Status display

7.3.9.1. To provide information on the status of the AS (set, unset, alarm setting period, alarm has been activated), the installation of optical displays is allowed inside and outside the passenger compartment. The light intensity of optical signals installed outside the passenger compartment shall not exceed 0.5 cd.

7.3.9.2. If an indication of short-term "dynamic" processes such as changes from "set" to "unset" and vice versa is provided, it shall be optical according to paragraph 7.3.10.1. Such optical indication may also be produced by the simultaneous operation of the direction indicators and/or passenger compartment lamp(s), provided that the duration of the optical indication by the direction indicators does not exceed 3 seconds.

7.3.10. Power supply

The source of power for the AS may be the vehicle battery. Where provided, an additional battery shall be rechargeable and it shall by no means supply energy to the other parts of the vehicle electrical system.

7.3.11. Specifications for optional functions

7.3.11.1. Self check, automatic failure indication

On setting the AS, irregular situations, e.g. open doors, etc., can be detected by a self-check function (plausibility control), and this situation is indicated.

7.3.11.2. Panic alarm

An optical and/or audible and/or radio alarm is allowed independent of the state (set or unset) and/or function of the AS. Such an alarm shall be triggered from within the vehicle and shall not affect the state (set or unset) of the AS. Also it must be possible for the vehicle user to switch off the panic alarm. In the case of an audible alarm, its sounding duration per activation shall not be restricted. A panic alarm shall not immobilize the engine or stop it if it is running.

7.4. TEST CONDITIONS

All components of the VAS or AS shall be tested in accordance with procedures described in paragraph 6.4.

This requirement does not apply to:

7.4.1. Those components that are fitted and tested as part of the vehicle, whether or not a VAS/AS is fitted (e.g. lamps); or,

7.4.2. Those components that have previously been tested as part of the vehicle and documentary evidence has been provided.

7.5. INSTRUCTIONS

Each vehicle shall be accompanied by:

7.5.1. Instructions for use.

7.5.2. Instructions for maintenance.

7.5.3. A general warning regarding the danger of making any alterations or additions to the system.

8. PART IV: APPROVAL OF IMMOBILIZERS AND APPROVAL OF A VEHICLE WITH REGARD TO ITS IMMOBILIZER

8.1. DEFINITIONS

For the purpose of Part IV of this Regulation,

8.1.1. "Immobilizer" means a device which is intended to prevent normal driving away of a vehicle under its own power (prevention of unauthorized use).

8.1.2. "Control equipment" means equipment necessary for the setting and/or unsetting of an immobilizer.

8.1.3. "Status display" means any device intended to indicate the status of the immobilizer (set/unset, change of set to unset and vice versa).

8.1.4. "Set state" means the state in which the vehicle cannot be driven normally under its own power.

8.1.5. "Unset state" means the state in which the vehicle can be driven normally.

8.1.6. "Key" means any device designed and constructed to provide a method of operating a locking system, which is designed and constructed to be operated only by that device.

8.1.7. "Override" means a design feature which locks the immobilizer in the unset condition.

8.1.8. "Rolling code" means an electronic code consisting of several elements the combination of which changes at random after each operation of the transmitting unit.

8.1.9. "Type of immobilizer" means systems which do not differ significantly in such essential aspects as:

- (a) the manufacturer's trade name or mark,
- (b) the kind of control equipment,
- (c) the design of their operation on the relevant vehicle system(s) (as referred to in paragraph 8.3.1. below).

8.1.10. "Vehicle type with regard to its immobilizer" means vehicles which do not differ significantly in such essential aspects as:

- (a) the manufacturer's trade name or mark,
- (b) vehicle features which significantly influence the performances of the immobilizer,
- (c) the type and design of the immobilizer.

8.2. GENERAL SPECIFICATIONS

8.2.1. It must be possible to set and unset the immobilizer in accordance with these requirements.

8.2.2. If the immobilizer includes the possibility of a radio transmission, e.g. for setting or unsetting, it shall comply with the relevant ETSI Standards (see footnote 5/ pertinent to paragraph 6.2.3.), e.g. EN 300 220-1 V1.3.1. (2000-09), EN 300 220-2 V1.3.1. (2000-09), EN 300 220-3 V1.1.1. (2000-09) and EN 301 489-3 V1.2.1. (2000-08) (including any advisory requirements). The frequency and maximum radiated power of radio transmissions for the setting and unsetting of the alarm system must comply with the CEPT/ERC (see footnote 6/ pertinent to paragraph 6.2.3.) Recommendation 70-03 (17 February 2000) relating to the use of short range devices (see footnote 7/ pertinent to paragraph 6.2.3.).

8.2.3. An immobilizer and its installation shall be so designed that any equipped vehicle continues to meet the technical requirements.

8.2.4. It shall not be possible for an immobilizer to enter the set state when the ignition key is in the engine running mode, except when:

- (a) the vehicle is equipped on intended to be equipped for ambulance, fire brigade or police purposes; or
- (b) the engine is required to:
 - (i) drive machinery forming part of, or mounted on, the vehicle for purposes other than driving the vehicle; or
 - (ii) maintain the electrical power of the batteries of the vehicle at a level required for driving that machinery or apparatus;

and the vehicle is stationary with the parking brake applied. When this exception is used, this fact shall be stated under item 2 of the addendum to the communication document (Annex 2 to this Regulation).

- 8.2.5. It shall not be possible to permanently override an immobilizer.
- 8.2.6. The immobilizer shall be designed and built such that when installed it shall not adversely affect the designed function and the safe operation of the vehicle, even in the case of malfunction.
- 8.2.7. An immobilizer shall be designed and built such that, when installed on a vehicle, according to the manufacturer's instructions, it cannot rapidly and without attracting attention be rendered ineffective or destroyed by, e.g. the use of low cost easily concealed tools, equipment or fabrications readily available to the public at large. It shall be difficult and time consuming to replace a major component or assembly in order to bypass the immobilizer.
- 8.2.8. An immobilizer shall be so designed and built such that when installed as specified by the manufacturer it is able to withstand the environment within the vehicle for a reasonable lifetime (for testing see paragraph 8.4.). More particularly the electrical properties of the on-board circuitry shall not be adversely affected by the addition of the immobilizer (lead cross-sections, contact safety, etc.)
- 8.2.9. An immobilizer may be combined with other vehicle systems or may be integrated into them (e.g. engine management, alarm systems).
- 8.2.10. It shall not be possible for an immobilizer to prevent the release of the brakes of the vehicle, except in the case of an immobilizer which prevents the release of pneumatically released spring brakes ^{9/} and functions in such a way that in normal operation, or in failure conditions, the technical requirements of Regulation No. 13 in force at the time of application for type approval under this Regulation are satisfied.
- Compliance with this paragraph does not exempt an immobilizer which prevents the release of pneumatically released spring brakes from the technical requirements set out in this Regulation.
- 8.2.11. It shall not be possible for an immobilizer to operate in such a manner as to apply the brakes of the vehicle.

^{9/} As defined in Annex 8 of ECE Regulation No. 13, as amended.

8.3. PARTICULAR SPECIFICATIONS

8.3.1. Extent of disablement

8.3.1.1. An immobilizer shall be designed so as to prevent the operation of the vehicle under its own power by at least one of the following means:

8.3.1.1.1. disable, in the case of after-market fitting, or vehicle equipped with diesel engine, at least two separate vehicle circuits that are needed for vehicle operation under its own power (e.g. starter motor, ignition, fuel supply, pneumatically released spring brakes, etc.);

8.3.1.1.2. interference by code of at least one control unit required for the operation of the vehicle.

8.3.1.2. An immobilizer for fitment to a vehicle equipped with a catalytic converter shall not cause unburnt fuel to enter the exhaust.

8.3.2. Operating reliability

Operating reliability shall be achieved by suitable design of the immobilizer, account being taken of specific environmental conditions in the vehicle (see paragraphs 8.2.8. and 8.4.).

8.3.3. Operating safety

It shall be ensured that the immobilizer does not change its state (set/unset) as a result of any of the tests in paragraph 8.4.

8.3.4. Setting of the immobilizer

8.3.4.1. The immobilizer must be set without supplementary action from the driver by at least one of the following means:

(a) at rotation of the ignition key into the "0" position in the ignition lock and activation of a door; in addition, immobilizers which unset immediately before or during the normal starting procedure of the vehicle are permitted to set on turning the ignition off,

(b) a maximum of 5 minutes after removing the key of the ignition lock.

8.3.4.2. If the immobilizer can enter the set state when the ignition key is in the engine running mode as provided for in paragraph 8.2.4., the immobilizer may also be set by the opening of the driver's door and/or the authorised user carrying out a deliberate action.

8.3.5. Unsetting

8.3.5.1. Unsetting shall be achieved by using one or a combination of the following devices. Other devices with an equivalent level of security giving equivalent performance are permitted.

8.3.5.1.1. A key pad for inputting an individually selectable code having at least 10,000 variants.

8.3.5.1.2. Electrical/electronic device, e.g. remote control, with at least 50,000 variants and shall incorporate rolling codes and/or have a minimum scan time of ten days, e.g. a maximum of 5,000 variants per 24 hours for 50,000 variants minimum.

8.3.5.1.3. If unsetting can be achieved via a remote control, the immobilizer must return to the set condition within 5 minutes after unsetting if no supplementary action on the starter circuit has been undertaken.

8.3.6. Status display

8.3.6.1. To provide information on the status of the immobilizer (set/unset, change of set to unset and vice versa), optical displays inside and outside the passenger compartment are allowed. The light intensity of optical signals installed outside the passenger compartment shall not exceed 0.5 cd.

8.3.6.2. If an indication of short-term "dynamic" processes such as changes from "set" to "unset" and vice versa is provided, it shall be optical, according to paragraph 8.3.6.1. Such optical indication may also be produced by the simultaneous operation of the direction indicators and/or passenger compartment lamp(s), provided that the duration of the optical indication by the direction indicators does not exceed 3 seconds.

8.4. OPERATION PARAMETERS AND TEST CONDITIONS

8.4.1. Operation parameters

All components of the immobilizer shall comply with prescriptions given in paragraph 6.4. of this Regulation.

This requirement does not apply to:

- (i) those components that are fitted and tested as part of the vehicle, whether or not an immobilizer is fitted (e.g. lamps), or
- (ii) those components that have previously been tested as part of the vehicle and documentary evidence has been provided.

8.4.2. Test conditions

All the tests shall be carried out in sequence on a single immobilizer. However, at the discretion of the test authority, other samples may be used if this is not considered to affect the results of the other tests.

8.4.3. Operation test

Upon completion of all the tests specified below, the immobilizer shall be tested under the normal test conditions specified in paragraph 6.4.2.1.2. of this Regulation to check that it continues to function normally. Where necessary, fuses may be replaced prior to the test.

All components of the immobilizer shall comply with prescriptions given in paragraphs 6.4.2.2. to 6.4.2.8. and 6.4.2.12. of this Regulation.

8.5. INSTRUCTIONS

(Paragraphs 8.5.1. to 8.5.3. for the purposes of aftermarket installation only).

Each immobilizer shall be accompanied by:

8.5.1. Instructions for installation.

8.5.1.1. The list of vehicles and vehicle models for which the device is intended. This list may be specific or generic, e.g. "all cars with petrol engines and 12 V negative earth batteries".

8.5.1.2. The method of installation illustrated by photographs and/or very clear drawings.

8.5.1.3. Detailed installation instructions provided by the supplier shall be such that when correctly followed by a competent installer, the safety and reliability of the vehicle is not affected.

8.5.1.4. The supplied installation instructions shall identify the electrical power requirements of the immobilizer and, where relevant, shall advise an increasing of battery size.

8.5.1.5. The supplier shall provide post installation procedures for checking the vehicle. Particular attention shall be drawn to safety related features.

8.5.2. A blank installation certificate, an example of which is given in Annex 7.

- 8.5.3. A general statement to the immobilizer purchaser calling his attention to the following points:
- 8.5.3.1. the immobilizer should be installed in accordance with the manufacturer's instructions;
- 8.5.3.2. the selection of a good installer is recommended (the immobilizer manufacturer may be contacted to indicate appropriate installers);
- 8.5.3.3. the installation certificate supplied with the immobilizer should be completed by the installer.
- 8.5.4. Instructions for use.
- 8.5.5. Instructions for maintenance.
- 8.5.6. A general warning regarding the dangers of making any alterations or additions to the immobilizer; such alterations and additions would automatically invalidate the certificate of installation referred to in paragraph 8.5.2. above.
9. MODIFICATION OF THE TYPE AND EXTENSION OF APPROVAL
- 9.1. Every modification of a vehicle or component type with regard to this Regulation shall be notified to the administrative department which approved the vehicle or component type. The department may then either:
- 9.1.1. consider that the modifications made are unlikely to have an appreciable adverse effect and that in any case the component or the vehicle still complies with the requirements, or
- 9.1.2. require a further report from the technical service responsible for conducting the tests.
- 9.2. Confirmation or refusal of approval, specifying the alteration, shall be communicated by the procedure specified in paragraph 4.3. above to the Contracting Parties to the Agreement applying this Regulation.
- 9.3. The competent authority issuing the extension of approval shall assign a serial number to each communication form drawn up for such an extension.

10. CONFORMITY OF PRODUCTION PROCEDURES

The conformity of production procedures shall comply with those set out in the Agreement, Appendix 2 (E/ECE/324-E/ECE/TRANS/505/Rev.2), with the following requirements:

- 10.1. Vehicles/components under this Regulation shall be so manufactured as to conform to the type approved by meeting the requirements of the relevant part(s) of this Regulation.
- 10.2. For each type of vehicle or component the tests prescribed in the relevant part(s) of this Regulation shall be carried out on a statistically controlled and random basis, in accordance with one of the regular quality assurance procedures.
- 10.3. The authority which has granted approval may at any time verify the conformity control methods applied in each production facility. The normal frequency of these verifications shall be one every two years.

11. PENALTIES FOR NON-CONFORMITY OF PRODUCTION

- 11.1. The approval granted in respect of a vehicle/component type pursuant to this Regulation may be withdrawn if the requirements laid down in paragraph 10. above are not complied with.
- 11.2. If a Contracting Party to the Agreement applying this Regulation withdraws an approval it has previously granted, it shall forthwith so notify the other Contracting Parties applying this Regulation, by means of a form conforming to the model in Annex 2, Part 1, 2 or 3 as appropriate.

12. PRODUCTION DEFINITELY DISCONTINUED

If the holder of the approval completely ceases to manufacture a vehicle/component type approved in accordance with this Regulation, he shall so inform the authority which granted the approval. Upon receiving the relevant communication, that authority shall inform thereof the other Contracting Parties to the Agreement applying this Regulation by means of a form conforming to the model in Annex 2, Part 1, 2 or 3 as appropriate.

13. TRANSITIONAL PROVISIONS

Contracting Parties applying this Regulation shall not refuse existing approvals or extensions to such approvals granted to Regulations Nos. 18 and 97, other than in accordance with the transitional provisions specified in those Regulations.

14. NAMES AND ADDRESSES OF TECHNICAL SERVICES RESPONSIBLE FOR CONDUCTING APPROVAL TESTS, AND OF ADMINISTRATIVE DEPARTMENTS

The Contracting Parties to the Agreement applying this Regulation shall communicate to the United Nations secretariat the names and addresses of the technical services responsible for conducting approval tests and of the administrative departments which grant approval and to which forms certifying approval or extension or refusal or withdrawal of approval, issued in other countries are to be sent.

Annex 1 - Part 1

(Maximum format: A4 (210 mm x 297 mm))

INFORMATION DOCUMENT

in accordance with paragraphs 5., 7. and 8. as appropriate
of Regulation No. 116 relating to ECE system type approval of a
vehicle type with regard to the devices to prevent unauthorized use

without / including an alarm system 1/
without / including an immobilizer 1/

1. GENERAL

1.1. Make (trade name of manufacturer):

1.2. Type:

1.3. Means of identification of type, if marked on the device (b):

1.3.1. Location of that marking:

1.4. Category of vehicle (c):

1.5. Name and address of the manufacturer:

1.6. Location of the ECE approval mark:

1.7. Address(es) of assembly plant(s):

2. GENERAL CONSTRUCTION CHARACTERISTICS OF THE VEHICLE

2.1. Photographs and/or drawings of a representative vehicle:

2.2. Hand of drive: left / right 1/

3. MISCELLANEOUS

3.1. Devices to prevent unauthorized use of the vehicle

3.1.1. Protective device:

3.1.1.1. A detailed description of the vehicle type with regard to the arrangement and design
of the control or of the unit on which the protective device acts:

- 3.1.1.2. Drawings of the protective device and of its mounting on the vehicle:
- 3.1.1.3. A technical description of the device:
- 3.1.1.4. Details of the lock combinations use:
- 3.1.2. Vehicle immobilizer:
 - 3.1.2.1. type approval number, if available:
 - 3.1.2.2. For immobilizers not yet approved
 - 3.1.2.2.1. A detailed technical description of the vehicle immobilizer and of the measures taken against inadvertent activation:
 - 3.1.2.2.2. The system(s) on which the vehicle immobilizer acts:
 - 3.1.2.2.3. Number of effective interchangeable codes, if applicable:
 - 3.1.3. Alarm system, if any:
 - 3.1.3.1. type approval number, if available:
 - 3.1.3.2. For alarm systems not yet approved
 - 3.1.3.2.1. A detailed description of the alarm system and of the vehicle parts related to the alarm system installed:
 - 3.1.3.2.2. A list of the main components comprising the alarm system:

1/ Strike out what does not apply (there are cases where nothing needs to be deleted, when more than one entry is applicable).

- (b) If the means of identification of type contains characters not relevant to describe the vehicle, component or separate technical unit types covered in this information document, such characters shall be represented in the documentation by the symbol "?" (e.g. ABC??123??).
- (c) As defined in Annex 7 to the Consolidated Resolution on the Construction of Vehicles (R.E.3) (document TRANS/WP.29/78/Rev.1, as amended).

Annex 1 - Part 2

(Maximum format: A4 (210 mm x 297 mm))

INFORMATION DOCUMENT

in accordance with paragraph 6. of Regulation No. 116 relating to
ECE component type approval of an alarm system

1. GENERAL
 - 1.1. Make (trade name of manufacturer):
 - 1.2. Type:
 - 1.3. Means of identification of type, if marked on the device (b):
 - 1.3.1. Location of that marking:
 - 1.4. Name and address of manufacturer:
 - 1.5. Location of the ECE approval mark:
 - 1.6. Address(es) of assembly plant(s):
2. DESCRIPTION OF THE DEVICE
 - 2.1. A detailed description of the alarm system and of the vehicle parts related to the alarm system installed:
 - 2.1.1. A list of the main components comprising the alarm system:
 - 2.1.2. The measures taken against false alarms:
 - 2.2. Range of protection offered by the device:
 - 2.3. Method of setting/unsetting the device:
 - 2.4. Number of effective interchangeable codes, if applicable:

- 2.5. List of main components comprising the device and, if applicable, their reference marks:
3. DRAWINGS
 - 3.1. Drawings of the main components of the device (the drawings must show the intended space for ECE type approval mark or reference mark, as applicable):
4. INSTRUCTIONS
 - 4.1. List of vehicles to which the device is intended to be fitted:
 - 4.2. Description of the method of installation illustrated by photographs and/or drawings:
 - 4.3. Instructions for use:
 - 4.4. Instructions for maintenance, if any:

-
- (b) If the means of identification of type contains characters not relevant to describe the vehicle, component or separate technical unit types covered in this information document, such characters shall be represented in the documentation by the symbol "?" (e.g. ABC??123??).

Annex 1 - Part 3

(Maximum format: A4 (210 mm x 297 mm))

INFORMATION DOCUMENT

in accordance with paragraph 8. of Regulation No. 116 relating to
ECE component type approval of an immobilizer system

1. GENERAL
 - 1.1. Make (trade name of manufacturer):
 - 1.2. Type:
 - 1.3. Means of identification of type, if marked on the device (b):
 - 1.3.1. Location of that marking:
 - 1.4. Name and address of manufacturer:
 - 1.5. Location of the ECE approval mark:
 - 1.6. Address(es) of assembly plant(s):
2. DESCRIPTION OF THE DEVICE
 - 2.1. A detailed technical description of the vehicle immobilizer and of the measures taken against inadvertent activation:
 - 2.2. The vehicle system(s) on which the vehicle immobilizer acts:
 - 2.3. Method of setting/unsetting the device:
 - 2.4. Number of effective interchangeable codes, if applicable:
 - 2.5. List of main components comprising the device and, if applicable, their reference marks:

3. DRAWINGS

3.1. Drawings of the main components of the device (the drawings must show the intended space for ECE type approval mark):

4. INSTRUCTIONS

4.1. List of vehicles to which the device is intended to be fitted:

4.2. Description of the method of installation illustrated by photographs and/or drawings:

4.3. Instructions for use:

4.4. Instructions for maintenance, if any:

(b) If the means of identification of type contains characters not relevant to describe the vehicle, component or separate technical unit types covered in this information document, such characters shall be represented in the documentation by the symbol "?" (e.g. ABC??123??).

Annex 2 - Part 1

COMMUNICATION

(Maximum format: A4 (210 x 297 mm))



issued by :

Name of administration:

.....
.....
.....

concerning 2/: APPROVAL GRANTED
APPROVAL EXTENDED
APPROVAL REFUSED
APPROVAL WITHDRAWN
PRODUCTION DEFINITELY DISCONTINUED

of a vehicle type with regard to its devices to prevent unauthorized use pursuant to Regulation No. 116

without / including an alarm system 2/
without / including an immobilizer 2/

Approval No.

Extension No.

Reason for extension:

SECTION I

1. GENERAL

1.1. Make (trade name of manufacturer):

1.2. Type:

1.3. Means of identification of type, if marked on the vehicle/component/ separate technical unit 2/ (b):

1.3.1. Location of that marking:

1.4. Category of vehicle (c):

- 1.5. Name and address of manufacturer:
- 1.6. Location of the ECE approval mark:
- 1.7. Address(es) of assembly plant(s):

SECTION II

1. Additional information (where applicable): see addendum
2. Technical service responsible for carrying out the tests:
3. Date of test report:
4. Number of test report:
5. Remarks (if any): see addendum
6. Place:
7. Date:
8. Signature:
9. The index to the information package lodged with the approval authority, which may be obtained on request, is attached.

Addendum
to ECE type approval certificate No. ...

concerning the type approval of a vehicle with regard to Regulation No. 116

1. Additional information:
 - 1.1. Brief description of the device(s) against unauthorized use and the vehicle parts on which it (they) act(s):
 - 1.2. Brief description of the immobilizer:
 - 1.3. Brief description of the alarm system, if applicable, including rated supply voltage 3/:

2. Remarks:

-
- 1/ Distinguishing number of the country which has granted/extended/refused/ withdrawn approval (see approval provisions in the Regulation).
- 2/ Strike out what does not apply (there are cases where nothing needs to be deleted, when more than one entry is applicable).
- 3/ To be indicated only for vehicle alarm systems (VAS) to be used in vehicles whose rated supply voltage is not 12 Volts.
- (b) If the means of identification of type contains characters not relevant to describe the vehicle, component or separate technical unit types covered in this information document, such characters shall be represented in the documentation by the symbol "?" (e.g. ABC??123??).
- (c) As defined in Annex 7 to the Consolidated Resolution on the Construction of Vehicles (R.E.3) (document TRANS/WP.29/78/Rev.1, as amended).

Annex 2 - Part 2

COMMUNICATION

(Maximum format: A4 (210 x 297 mm))

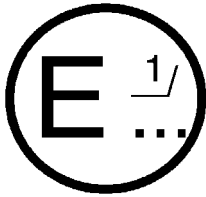

issued by :

Name of administration:

.....
.....
.....

concerning 2/:

- APPROVAL GRANTED
- APPROVAL EXTENDED
- APPROVAL REFUSED
- APPROVAL WITHDRAWN
- PRODUCTION DEFINITELY DISCONTINUED

of a component type as an alarm system pursuant to Regulation No. 116

Approval No.

Extension No.

Reason for extension:

SECTION I

1. GENERAL

1.1. Make (trade name of manufacturer):

1.2. Type:

1.3. Means of identification of type, if marked on the device (b):

1.3.1. Location of that marking:

1.4. Name and address of manufacturer:

1.5. Location of the ECE approval mark:

1.6. Address(es) of assembly plant(s):

SECTION II

1. Additional information (where applicable): see addendum
2. Technical service responsible for carrying out the tests:
3. Date of test report:
4. Number of test report:
5. Remarks (if any): see addendum
6. Place:
7. Date:
8. Signature:
9. The index to the information package lodged with the approval authority, which may be obtained on request, is attached.

Addendum
to ECE type approval certificate No. ...

concerning the type approval of a vehicle alarm system with regard to Regulation No. 116

1. Additional information:
 - 1.1. Brief description of the alarm system, if applicable, including rated supply voltage 3/:
 - 1.2. List of vehicles to which the alarm system is intended to be fitted:
 - 1.3. Types of vehicles on which the alarm system has been tested:
 - 1.4. List of main components, duly identified, comprising the alarm system:

2. Remarks:

-
- 1/ Distinguishing number of the country which has granted/extended/refused/ withdrawn approval (see approval provisions in the Regulation).
- 2/ Strike out what does not apply (there are cases where nothing needs to be deleted, when more than one entry is applicable).
- 3/ To be indicated only for vehicle alarm systems (VAS) to be used in vehicles whose rated supply voltage is not 12 Volts.
- (b) If the means of identification of type contains characters not relevant to describe the vehicle, component or separate technical unit types covered in this information document, such characters shall be represented in the documentation by the symbol "?" (e.g. ABC??123??).

SECTION II

1. Additional information (where applicable): see addendum
2. Technical service responsible for carrying out the tests:
3. Date of test report:
4. Number of test report:
5. Remarks (if any): see addendum
6. Place:
7. Date:
8. Signature:
9. The index to the information package lodged with the approval authority, which may be obtained on request, is attached.

Addendum

to ECE type approval certificate No. ...

concerning the type approval of an immobilizer with regard to Regulation No. 116

1. Additional information:
 - 1.1. Brief description of the immobilizer:
 - 1.2. List of vehicles to which the immobilizer is intended to be fitted:
 - 1.3. Types of vehicles on which the immobilizer has been tested:
 - 1.4. List of main components, duly identified, comprising the immobilizer:

2. Remarks:

-
- 1/ Distinguishing number of the country which has granted/extended/refused/ withdrawn approval (see approval provisions in the Regulation).
- 2/ Strike out what does not apply (there are cases where nothing needs to be deleted, when more than one entry is applicable).
- 3/ To be indicated only for vehicle alarm systems (VAS) to be used in vehicles whose rated supply voltage is not 12 Volts.
- (b) If the means of identification of type contains characters not relevant to describe the vehicle, component or separate technical unit types covered in this information document, such characters shall be represented in the documentation by the symbol "?" (e.g. ABC??123??).

Annex 3

ARRANGEMENTS OF APPROVAL MARKS

MODEL A

(see paragraph 4.4. of this Regulation)

Figure 1

(see paragraph 4.4.3.4. of this Regulation)

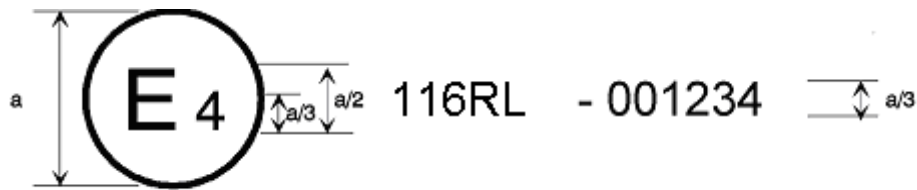

$a = 8 \text{ mm min}$

The above approval mark figure 1 affixed to a vehicle shows that the type concerned was approved in the Netherlands (E4) pursuant to Part I of Regulation No. 116 under approval No. 001234. The first two digits (00) of the approval number indicate that the approval was granted in accordance with the requirements of Regulation No. 116 in its original form.

Figure 2

(see paragraph 4.4.3.1. of this Regulation)

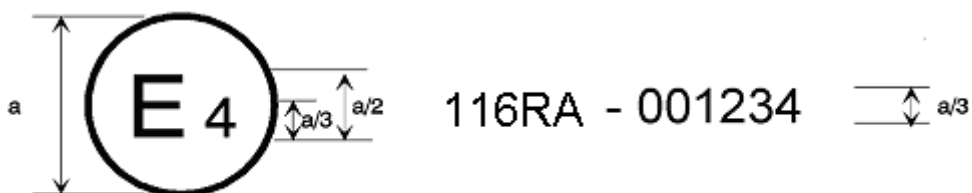

$a = 8 \text{ mm min}$

The above approval mark figure 2 affixed to a VAS shows that the type concerned was approved in the Netherlands (E4) pursuant to Part II of Regulation No. 116 under approval number 001234. The first two digits (00) of the approval number indicate that the approval was granted in accordance with the requirements of Regulation No. 116 in its original form.

Figure 3
 (see paragraph 4.4.3.2. of this Regulation)

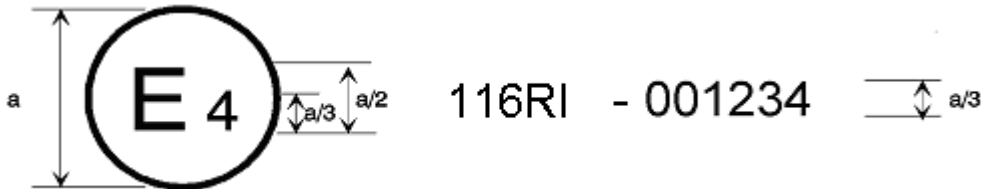

$a = 8 \text{ mm min}$

The above approval mark figure 3 affixed to an immobilizer shows that the type concerned was approved in the Netherlands (E 4) pursuant to Part IV of Regulation No. 116 under approval number 001234. The first two digits (00) of the approval number indicate that the approval was granted in accordance with the requirements of Regulation No. 116 in its original form.

Figure 4
 (see paragraph 4.4.3.5. of this Regulation)



$a = 8 \text{ mm min}$

The above approval mark figure 4 affixed to a vehicle shows that the type concerned was approved in the Netherlands (E 4) pursuant to Part III of Regulation No. 116 under approval number 001234. The first two digits (00) of the approval number indicate that the approval was granted in accordance with the requirements of Regulation No. 116 in its original form.

Figure 5
 (see paragraph 4.4.3.6. of this Regulation)

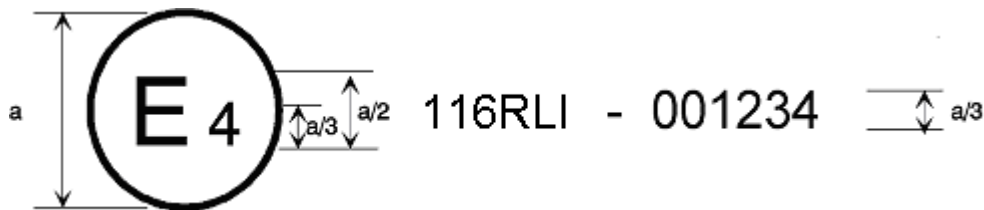

$a = 8 \text{ mm min}$

The above approval mark figure 5 affixed to a vehicle shows that the type concerned was approved in the Netherlands (E4) pursuant to Part I and IV of Regulation No. 116 under approval mark 001234. The first two digits (00) of the approval number indicate that the approval was granted in accordance with the requirements of Regulation No. 116 in its original form.

Figure 6
 (see paragraph 4.4.3.7. of this Regulation)

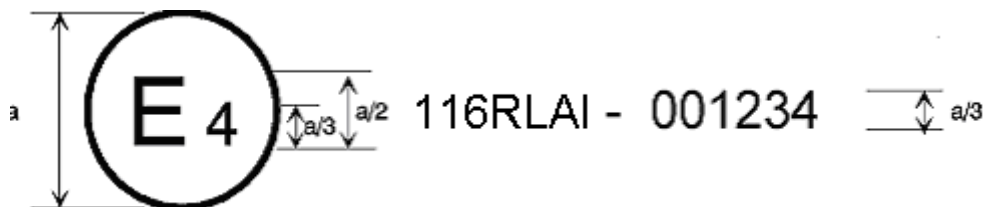

$a = 8 \text{ mm min}$

The above approval mark figure 6 affixed to a vehicle shows that the type concerned was approved in the Netherlands (E4) pursuant to Part I, II and IV of Regulation No. 116 under approval No. 001234. The first two digits (00) of the approval number indicate that the approval was granted in accordance with the requirements of Regulation No. 116 in its original form.

Model B
(see paragraph 4.5. of this Regulation)

Figure 7
(example)

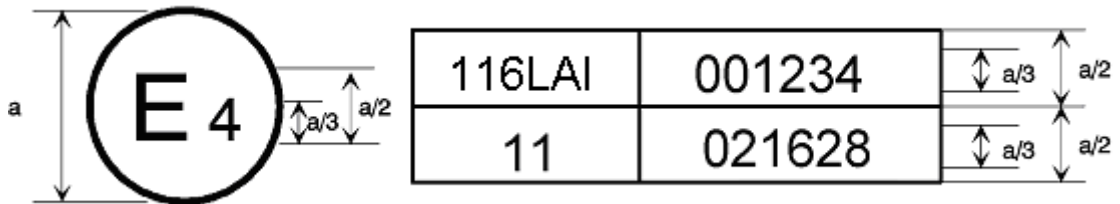

$a = 8 \text{ mm min}$

The above approval mark affixed to a vehicle shows that the type concerned was approved in the Netherlands (E4) pursuant to Parts I, II and IV of Regulation No. 116 and to Regulation No. 11. The first two digits of the approval number indicate that on the dates on which these approvals were granted, Regulation No. 116 was in its original form and Regulation No. 11 included the 02 series of amendments.

Annex 4 - Part I

WEAR PRODUCING TEST PROCEDURE FOR DEVICES TO PREVENT
UNAUTHORIZED USE ACTING ON THE STEERING

1. Test equipment

The test equipment shall consist of:

- 1.1. A fixture suitable for mounting the sample steering complete with the device to prevent unauthorized use attached, as defined in paragraph 5.1.2. of this Regulation.
- 1.2. A means for activating and deactivating the device to prevent unauthorized use which shall include the use of the key.
- 1.3. A means for rotating the steering shaft relative to the device to prevent unauthorized use.

2. Test method

- 2.1. A sample of the steering complete with the device to prevent unauthorized use is attached to the fixture referred to in paragraph 1.1. above.
- 2.2. One cycle of the test procedure shall consist of the following operations:
 - 2.2.1. Start position. The device to prevent unauthorized use shall be deactivated and the steering shaft shall be rotated to a position which prevents engagement of the device to prevent unauthorized use, unless it is of the type which permits locking in any position of the steering.
 - 2.2.2. Set to activate. The device to prevent unauthorized use shall be moved from the deactivated to the activated position, using the key.
 - 2.2.3. 1/ Activated. The steering spindle shall be rotated such that the torque on it, at the instant of engagement of the device to prevent unauthorized use, shall be $40 \text{ Nm} \pm 2 \text{ Nm}$.
 - 2.2.4. Deactivated. The device to prevent unauthorized use shall be deactivated by the normal means, the torque being reduced to zero to facilitate disengagement.
 - 2.2.5. 1/ Return. The steering spindle shall be rotated to a position which prevents engagement of the device to prevent unauthorized use.

- 2.2.6. Opposite rotation. Repeat procedures described in paragraphs 2.2.2., 2.2.3., 2.2.4. and 2.2.5, but in the opposite direction of rotation of the steering spindle.
- 2.2.7. The time interval between two successive engagements of the device shall be at least 10 seconds.
- 2.3. The wear-producing cycle shall be repeated the number of times specified in paragraph 5.3.1.3. of this Regulation.

1/ If the device to prevent unauthorized use permits locking in any position of the steering, the procedures described in paragraphs 2.2.3. and 2.2.5. shall be omitted.

Annex 4 - Part 2

TEST PROCEDURE FOR DEVICES TO PREVENT UNAUTHORIZED USE
ACTING ON THE STEERING USING A TORQUE LIMITING DEVICE

1. Test equipment

The test equipment shall consist of:

- 1.1. A fixture suitable for holding the relevant parts of a steering system or, if the test is carried out on a complete vehicle, a jacking system capable of lifting all the steered wheels clear of the ground, and
- 1.2. A device or devices capable of producing, and measuring, a torque applied to the steering control as prescribed in paragraph 2.3. The measurement precision must be less than or equal to 2 per cent.

2. Test procedure description

- 2.1. If the test is carried out on a complete vehicle, the test shall be carried out with all the steered wheels of the vehicle held clear of the ground.
- 2.2. The steering lock shall be activated such that the steering is blocked.
- 2.3. A torque shall be applied to the steering control such that it rotates.
- 2.4. The test cycle includes a rotation of the steering control of 90° followed by a rotation in the opposite direction of 180°, and a new rotation of 90° in the original direction (see figure);
1 cycle = +90° / -180° / +90° with a tolerance of " 10 per cent.

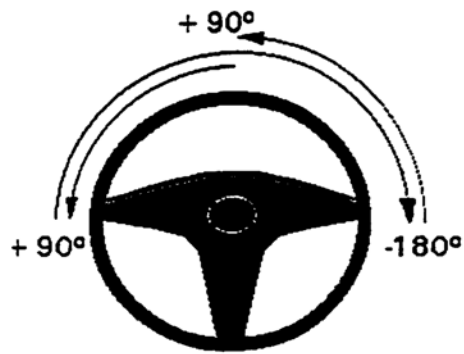

- 2.5. A cycle duration is equal to 20 s " 2 s.
- 2.6. Five test cycles shall be carried out.
- 2.7. During each of the test cycles the minimum recorded value of the torque shall be higher than that given in paragraph 5.3.1.4.2. of this Regulation.

Annex 5

ELECTRICALLY POWERED SYSTEM TEST

1. Carry out the following procedure with an appropriate closure in the closed locked position.
 - 1.1. Disconnect the battery positive (+) lead for 4 min.
 - 1.2. Reconnect the battery positive (+) lead.
 - 1.3. Disconnect the battery negative (-) lead for 4 min.
 - 1.4. Reconnect the battery negative (-) lead.
 - 1.5. Reverse the normal polarity of the supply to the system for 4 min.
 - 1.6. Increase the supply voltage to twice the normal system voltage for 4 min.
 - 1.7. Expose the system to an electromagnetic field of 24 V/m over a frequency range of 20 Mhz to 1,000 Mhz.

NOTE: The system may be isolated so as to protect non-security systems not under test.

Annex 6

MODEL OF CERTIFICATE OF CONFORMITY

I the undersigned
(surname and name)

Testify that the vehicle alarm system / immobilizer 1/ described below:

Make:

Type:

is in total conformity with the type approved

at on
(place of approval) (date)

as described in the communication form bearing approval No.

Identification of the main component(s):

Component: Marking:

Done at: on:

Manufacturer's full address and stamp:

Signature : (please specify position)

1/ Strike out what does not apply.

Annex 7

MODEL OF INSTALLATION CERTIFICATE

I the undersigned
professional installer, certify that the installation of the vehicle alarm system / immobilizer 1/
described below has been carried out by myself pursuant to the mounting instructions supplied by
the manufacturer of the system.

Description of the vehicle

Make:

Type:

Serial number:

Registration number:

Description of the vehicle alarm system/ or immobilizer 1/

Make:

Type:

Approval number:

Done at: on:

Installer's full address and stamp:

.....

.....

Signature: (please specify position)

1/ Strike out what does not apply.

Annex 8

Paragraphs 6.4.2.11. and 7.4

TEST OF SYSTEMS FOR THE PROTECTION OF THE PASSENGER COMPARTMENT

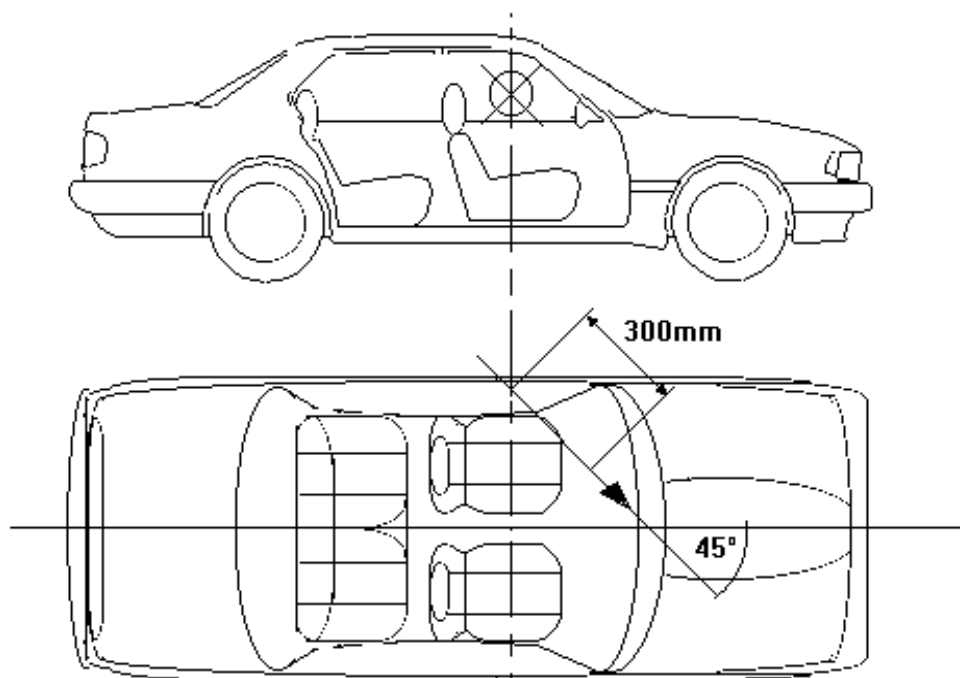

Annex 9

ELECTROMAGNETIC COMPATIBILITY

Note: To test the electromagnetic compatibility, either paragraph 1. or paragraph 2. shall be used, depending on the test facilities.

1. METHOD ISO

Immunity against disturbances conducted along supply lines

Apply the test pulses 1, 2, 3a, 3b, 4 and 5 according to the International Standard ISO 7637-1:1990 to the supply lines as well as to other connections of VAS/AS which may be operationally connected to supply lines.

VAS/AS in unset state

The test pulses 1 through 5, shall be applied with a degree of severity III. The required functional status for all applied test pulses shall be A.

VAS/AS in set state

The test pulses 1 through 5 shall be applied. The required functional status for all applied test pulses are given in table 1.

Table 1 – Severity/functional status (for supply lines)

Test pulse number	Test level	Functional status
1	III	C
2	III	A
3a	III	C
3b	III	A
4	III	B
4	I	A
5	III	A

Immunity against disturbance coupled on signal lines

Leads which are not connected to supply lines (e.g. special signal lines) shall be tested in accordance with the International Standard ISO7637-3:1995 (and Corr.1). The required functional status for all applied test pulses are given in table 2.

Table 2 – Test level / functional status (for signal lines)

Test pulse number	Test level	Functional status
3a	III	C
3b	III	A

Immunity against radiated high frequency disturbances

Testing of the immunity of a VAS/AS in a vehicle may be performed according to the prescriptions in Regulation No. 10, 02 series of amendments and test methods described in Annex 6 for the vehicles and Annex 9 for a separate technical unit.

Electrical disturbance from electrostatic discharges

Immunity against electrical disturbances shall be tested in accordance with Technical Report ISO/TR 10605-1993.

Radiated emissions

Tests shall be performed according to Regulation No. 10, 02 series of amendments prescriptions and according to the test methods described in annexes 4 and 5 for vehicles or annexes 7 and 8, for a separate technical unit.

2. METHOD IEC

Electromagnetic field

The VAS/AS shall undergo the basic test. It shall be subjected to the electromagnetic field test described in IEC Publication 839-1-3-1998 test A-13 with a frequency range from 20 to 1000 MHz, and for a field strength level of 30 V/m.

In addition, the VAS/AS shall be subjected to the electrical transient conducted and coupled tests described in the International Standard ISO 7637 Parts 1:1990, 2:1990 and 3:1995, as appropriate.

Electrical disturbance from electrostatic discharges

The VAS/AS shall undergo the basic test. It shall be subjected to testing for immunity against electrostatic discharge as described in either EN 61000-4-2, or ISO/TR 10605-1993, at the manufacturer's choice.

Radiated emissions

The VAS/AS shall be subjected to testing for the suppression of radio frequency interference according to tests prescribed in Regulation No. 10, 02 series of amendments and according to tests method described in annexes 4 and 5 for vehicles and annexes 7 and 8 for a separate technical unit.

Annex 10

SPECIFICATIONS FOR MECHANICAL KEY SWITCHES

1. The cylinder of the key switch shall not protrude by more than 1 mm from the cowling, and the protruding part shall be conical.
2. The joint between the cylinder core and the cylinder casing shall be capable of withstanding a tensile force of 600 N and a torque of 25 Nm.
3. The key switch shall be provided with a cylinder drill obstruction.
4. The key profile shall have at least 1,000 effective permutations.
5. The key switch shall not be operable by a key which differs by only one permutation from the key matching the key switch.
6. The key aperture to an external key switch shall be shuttered or otherwise protected against the penetration of dirt and/or water.
