

2 December 2013

Agreement

Concerning the Adoption of Uniform Technical Prescriptions for Wheeled Vehicles, Equipment and Parts which can be Fitted and/or be Used on Wheeled Vehicles and the Conditions for Reciprocal Recognition of Approvals Granted on the Basis of these Prescriptions*

(Revision 2, including the amendments which entered into force on 16 October 1995)

Addendum 105: Regulation No. 106

Revision 2

Incorporating all valid text up to:

Corrigendum 1 to Revision 1 of the Regulation (*Erratum by the secretariat*)

Supplement 7 to the original version of the Regulation - Date of entry into force: 24 October 2009

Supplement 8 to the original version of the Regulation - Date of entry into force: 17 March 2010

Supplement 9 to the original version of the Regulation - Date of entry into force: 27 January 2013

Supplement 10 to the original version of the Regulation - Date of entry into force: 3 November 2013

Uniform provisions concerning the approval of pneumatic tyres for agricultural vehicles and their trailers



UNITED NATIONS

* Former title of the Agreement: Agreement Concerning the Adoption of Uniform Conditions of Approval and Reciprocal Recognition of Approval for Motor Vehicle Equipment and Parts, done at Geneva on 20 March 1958.

Regulation No. 106

Uniform provisions concerning the approval of pneumatic tyres for agricultural vehicles and their trailers

Page

Contents

Regulation

1.	Scope	4
2.	Definitions.....	4
3.	Markings	9
4.	Application for approval	10
5.	Approval.....	11
6.	Requirements.....	12
7.	Modification of tyre type and extension of approval	14
8.	Conformity of production.....	15
9.	Penalties for non-conformity of production	15
10.	Production definitively discontinued.....	15
11.	Names and addresses of Technical Services responsible for conducting approval tests, of test laboratories, and of Type Approval Authorities	15

Annexes

1	Communication	17
2	Arrangement of approval mark	19
3	Arrangement of tyre markings	20
4	List of load capacity indices (LI) and corresponding maximum mass to be carried (kg).....	25
5	Theoretical rim, outer diameter and nominal section width of tyres of certain size designations	26
6	Test method for measuring tyre dimensions	45
7	Variation of load capacity with speed	46
8	Test procedure to assess tyre resistance to bursting	49
9	Load/speed test procedure.....	50
10	Tyre classification code.....	53
11	Example of the pictogram to be marked on both tyre sidewalls of the tyres to explicit the maximum inflation pressure not to be exceeded for bead seating during tyre mounting	54

1. Scope

This Regulation covers new pneumatic tyres designed primarily, but not only, for agricultural and forestry vehicles (power-driven vehicles in category T¹), agricultural machines (power-driven and trailed) and agricultural trailers, and identified by speed category symbols corresponding to speeds of 65 km/h (speed symbol "D") and below.

It does not apply to tyre types designated primarily for other purposes, such as:

- (a) Construction application (tyres marked "Industrial" or "IND" or "R4" or "F3");
- (b) Earth-moving equipment;
- (c) Industrial and lift trucks.

2. Definitions

For the purposes of this Regulation:

- 2.1. "*Type of agricultural tyre*" means a category of tyres which do not differ in such essential respects as:
 - 2.1.1. The manufacturer;
 - 2.1.2. Tyre-size designation;
 - 2.1.3. Category of use:
 - (a) Tractor - steering wheel;
 - (b) Tractor - drive wheel - standard tread;
 - (c) Tractor - drive wheel - special tread;
 - (d) Implement - traction;
 - (e) Implement - trailer;
 - (f) Implement - mixed applications;
 - (g) Forestry machines – standard tread;
 - (h) Forestry machines – special tread.
 - 2.1.4. Structure (diagonal (bias-ply), bias-belted, radial-ply);
 - 2.1.5. Speed category symbol;
 - 2.1.6. Load capacity index;
 - 2.1.7. Tyre cross-section;
- 2.2. For reference on the following terms see explanatory figure in Appendix 1.

¹ As defined in the Consolidated Resolution on the Construction of Vehicles (R.E.3.), document ECE/TRANS/WP.29/78/Rev.2, para. 2. - www.unece.org/trans/main/wp29/wgs/wp29gen/wp29resolutions.html

- 2.3. "Structure of a tyre" means the technical characteristics of the tyre carcass. The following structures are distinguished in particular:
- 2.3.1. "Diagonal" or "bias-ply" describes a tyre structure in which the ply cords extend to the bead and are laid at alternate angles of substantially less than 90° to the centreline of the tread;
- 2.3.2. "Bias-belted" describes a tyre structure of diagonal (bias-ply) type in which the carcass is restricted by a belt comprising two or more layers of substantially inextensible cord material laid at alternate angles close to those of the carcass;
- 2.3.3. "Radial" describes a tyre structure in which the ply cords extend to the beads and are laid substantially at 90° to the centreline of the tread, the carcass being stabilised by an essentially inextensible circumferential belt;
- 2.4. "Bead" means the part of a tyre which is of such shape and structure as to fit the rim and hold the tyre on it;
- 2.5. "Cord" means the strands forming the fabric of the plies in the tyre;
- 2.6. "Ply" means a layer of rubber-coated parallel cords;
- 2.7. "Carcass" means that part of a tyre other than the tread and the rubber sidewalls which, when inflated, bears the load;
- 2.8. "Tread" means that part of a tyre which comes into contact with the ground;
- 2.9. "Sidewall" means the part of the tyre, excluding the tread, which is visible when the tyre, fitted to a rim, is viewed from the side;
- 2.10. "Section width (S)" means the linear distance between the outsides of the sidewalls of an inflated tyre, excluding elevations due to labelling (marking), decoration or protective bands or ribs;
- 2.11. "Overall width" means the linear distance between the outside of the sidewalls of an inflated tyre, including labelling (marking), decoration and protective bands or ribs;
- 2.12. "Section height (h)" means a distance equal to half the difference between the outer diameter of the tyre and the nominal rim diameter;
- 2.13. "Nominal aspect ratio (Ra)" means one hundred times the number obtained by dividing the number expressing the nominal section height in millimetres by the number expressing the nominal section width in millimetres;
- 2.14. "Outer diameter (D)" means the overall diameter of an inflated new tyre;
- 2.15. "Tyre-size designation" means a designation showing:
- 2.15.1. The nominal section width (S1). This value must be expressed in mm.
- 2.15.2. The nominal aspect ratio (Ra).
- 2.15.3. An indication of the structure, placed in front of the nominal rim diameter marking, as follows:
- 2.15.3.1. On diagonal (bias-ply) tyres, the symbol "-" or the letter "D";
- 2.15.3.2. On radial-ply tyres, the letter "R";
- 2.15.3.3. On bias-belted tyres, the letter "B".
- 2.15.4. The conventional number "d" denoting the nominal rim diameter;

- 2.15.5. Optionally, the letters "IMP" after the nominal rim diameter marking in case of implement tyres;
- 2.15.6. Optionally, the letters "FRONT" after the nominal rim diameter marking in case of tractor steering wheel tyres;
- 2.15.7. However for tyres listed in Annex 5 the "tyre size designation" is that shown in the first column of those tables.
- 2.15.8. The letters "IF" before the nominal section width in case of "Improved Flexion Tyre".
The letters "VF" before the nominal section width in case of "Very High Flexion Tyre".
- 2.15.9. The letters "CFO" after the nominal rim diameter marking in case of "Improved Flexion" or "Very High Flexion" tractor-drive wheel tyres specifically designed for the equipments of machines to be used in Cyclic Field Operations.
- 2.15.10. The letters "CHO" after the nominal rim diameter marking in case of standard tractor-drive wheel tyres specifically designed for the equipments of machines to be used in Cyclic Harvesting Operations.
- 2.16. "*Nominal rim diameter (d)*" means a conventional number denoting the nominal diameter of the rim on which a tyre is designed to be mounted and corresponding to the diameter of the rim expressed either by size codes (number below 100 - see table for equivalence with millimeters) or in mm (numbers above 100) but not both;

"d" symbol expressed by codes	Value to be used for the calculation in paras. 6.2.1 and 6.4 (mm)
4	102
5	127
6	152
7	178
8	203
9	229
10	254
11	279
12	305
13	330
14	356
15	381
15.3	389
16	406
16.1	409
17	432

"d" symbol expressed by codes	Value to be used for the calculation in paras. 6.2.1 and 6.4 (mm)
18	457
19	483
20	508
21	533
22	559
24	610
25	635
26	660
28	711
30	762
32	813
34	864
36	914
38	965
40	1016
42	1067

"d" symbol expressed by codes	Value to be used for the calculation in paras. 6.2.1 and 6.4 (mm)
44	1118
46	1168
48	1219
50	1270
52	1321
54	1372
14.5	368
15.5	394
16.5	419
17.5	445
19.5	495
20.5	521
22.5	572
24.5	622
26.5	673
30.5	775

- 2.17. "*Rim*" means the support for a tyre-and-tube assembly, or for a tubeless tyre, on which the tyre beads are seated;

- 2.18. "*Theoretical rim*" means the notional rim whose width would be equal to X times the nominal section width of a tyre; the value "X" must be specified by the tyre manufacturer or the reference rim width is that mentioned in Annex 5 for the relevant "tyre size designation";
- 2.19. "*Measuring rim*" means the rim on which a tyre is fitted for the measurement of the dimensions;
- 2.20. "*Tractor-drive wheel tyre*" means a tyre designed to be fitted to driven axles of agricultural and forestry tractors (vehicles in categories T) suitable for sustained high torque service. The tread pattern of the tyre consists of lugs or cleats;
- 2.20.1. "*Improved Flexion Tyre*" or "*Very High Flexion Tyre*" describes a pneumatic-tyre structure in which the carcass is more resistant than that of the corresponding standard tyre.
- 2.21. "*Tractor steering wheel tyre*" means a tyre designed to be fitted to non-driven axles of agricultural and forestry tractors (motor vehicles in category T). The tread pattern of the tyre generally consists of circumferential grooves and ribs;
- 2.22. "*Implement tyre*" means a tyre designed primarily for agricultural machines or implements (vehicles in category S) or for agricultural trailers (vehicles in category R); however it may also equip either front steering wheels and drive wheels of agricultural and forestry tractors (vehicles in category T), but it is not suitable for sustained high torque services;
- 2.23. "*Traction tyre*" means a tyre designed primarily for the equipment of driven axles of implements or agricultural machinery, excluding sustained high torque services. The tread pattern of the tyre generally consists of lugs or cleats. The type of application is identified with the symbol:



- 2.24. "*Trailer tyre*" means a tyre designed for the equipment of non-driven (trailed) axles of implements, agricultural machinery or trailers;

The type of application is identified with the symbol:

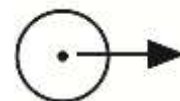

- 2.25. "*Mixed applications tyre*" means a tyre designed to be fitted to either driven and non-driven axles of implements, agricultural machinery or trailers;
- 2.26. "*Service description*" means the association of a load capacity index with a speed category symbol;
- 2.26.1. In case of implement tyres the service description is supplemented with the relevant symbol for the type of application concerned (traction or trailer) as defined in paragraphs 2.23. and 2.24.
- 2.27. "*Supplementary service description*" means an additional service description, marked within a circle, to identify a special type of service (load rating and speed category) to which the tyre type is also allowed in addition to the applicable load variation with speed (see Annex 7);

2.28. "*Load-capacity index*" means one number which indicates the load the tyre can carry in single formation at the speed corresponding to the associated speed category and when operated in conformity with the requirements governing utilisation specified by the manufacturer. The list of these indices and their corresponding masses is given in Annex 4;

2.29. "*Speed category*", the reference speed expressed by the speed category symbol as shown in the table below:

<i>Speed category symbol</i>	<i>Reference speed (km/h)</i>
A2	10
A4	20
A6	30
A8	40
B	50
D	65

2.30. "*Table: Variation of load capacity with speed*" means the tables in Annex 7 showing as a function of the category of use, the type of application, the load capacity index and the nominal speed category symbol, the maximum load rating variations which a tyre can withstand when used at speeds different from that corresponding to its speed category symbol;

2.30.1. The table "Variation of load capacity with speed" is not applicable to the "supplementary service description".

2.30.2. The table "Variation of load capacity with speed" is not applicable to "Improved Flexion" or "Very High Flexion" tyres."

2.31. "*Maximum load rating*" means the maximum mass the tyre is rated to carry:

2.31.1. It must not exceed the percentage of the value associated with the relevant load capacity index of the tyre as indicated in the table "Load-capacity variation with speed" (see paragraph 2.30. above), with reference to the category of use, the speed category symbol of the tyre and the speed capability of the vehicle to which the tyre is fitted;

2.32. "*Tread groove*" means the space between the adjacent ribs or blocks in the tread pattern;

2.33. "*Tread lug (or cleat)*" means the solid-block element protruding from the base of the tread pattern;

2.34. "*Special tread*" means a tyre, the tread pattern and structure of which are primarily designed to ensure in marshy areas a better grip than that of a standard tread tyre. The tread pattern of the tyre generally consists of lugs or cleats deeper than those of a standard tyre;

2.35. "*Chunking*" means the breaking away of small pieces of rubber from the tread;

2.36. "*Cord separation*" means the parting of the cords from their rubber coating;

2.37. "*Ply separation*" means the parting of adjacent plies;

2.38. "*Tread separation*" means the pulling away of the tread from the carcass;

- 2.39. "Test rim" means the rim on which a tyre must be fitted for the performance test;
- 2.40. "Tyre classification code" means the optional marking detailed in Annex 10 that identifies the category of use and the particular type of tread pattern and application as specified by ISO 4251-4.
- 2.41. *Forestry tyre* means a tyre designed to be fitted to machines or equipments used in forestry applications.

3. Markings

- 3.1. Tyres must bear:
- 3.1.1. The manufacturer's trade name or mark;
- 3.1.2. The tyre-size designation as defined in paragraph 2.15.;
- 3.1.3. An indication of the structure as follows:
- 3.1.3.1. On diagonal (bias-ply) tyres, no additional marking;
- 3.1.3.2. On radial-ply tyres, optionally, the word "RADIAL";
- 3.1.3.3. On bias-belted tyres, the words "BIAS-BELTED";
- 3.1.4. The "service description" as defined in paragraph 2.26.
- 3.1.4.1. In the case of implement tyre, the service description must be supplemented with the relevant application symbol;
- 3.1.4.2. In the case of implement tyre for mixed applications the tyre must be marked with two service descriptions one for "trailer" applications and the other for "traction" applications, each supplemented with the relevant symbol (see paragraphs 2.23. and 2.24. above) as follows:

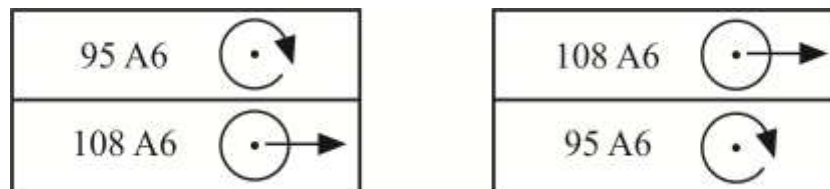

- 3.1.5. The supplementary service description, if applicable.
- 3.1.6. The inscription "DEEP" (or "R-2") in the case of a special tread tyre;
- 3.1.7. The inscriptions "F-1" or "F-2" in the case of a tractor steering wheel tyre that is not already marked as per paragraph 2.15.6. above;
- 3.1.8. The inscriptions 'LS-1', 'LS-2', 'LS-3' or 'LS-4' in the case of tyres for forestry machines.
- 3.1.8.1. "LS-3" identifies special tread tyres.
- 3.1.8.2. The inscription 'I-3' for implement tyres with traction tread as identified in Annex 5, Tables 5 and 6.
- 3.1.9. The inscription "IMPLEMENT" in the case of an implement tyre that is not already marked as per paragraph 2.15.5. above;
- 3.1.10. The word "TUBELESS" if the tyre is designed for use without an inner tube;

- 3.1.11. The inscription "... bar MAX." (or "... kPa MAX") inside the pictogram shown in Annex 11, to notify the cold inflation pressure that shall not be exceeded for bead seating during tyre mounting.
- 3.1.12. The inscription "IF" shall be added in front of the tyre-size designation when the tyre is "Improved Flexion Tyre".
The inscription "VF" shall be added in front of the tyre-size designation when the tyre is "Very High Flexion Tyre".
- 3.1.13. The inscriptions "CFO" or "CHO", if applicable, may be marked after the nominal rim diameter.
- 3.2. The tyre must also be marked with the date of manufacture in the form of a group of four digits, the first two showing the week and the last two the year of manufacture. However, this marking shall not be mandatory on any tyre submitted for approval until two years after the date of entry into force of this Regulation.²
- 3.3. The tyre must also bear the type approval mark, the model of which is given in Annex 2.
- 3.4. Position of markings
 - 3.4.1. The markings referred to in paragraph 3.1. above shall be moulded on both sidewalls of the tyre.
 - 3.4.2. The markings referred to in paragraphs 3.2. and 3.3. above shall be moulded on one sidewall only.
 - 3.4.3. All markings must be clearly and legibly moulded and produced as part of the process during manufacture. The use of branding or other methods of marking after completion of the original manufacturing process is not permitted.
- 3.5. Annex 3 gives examples of the arrangement of tyre markings.

4. Application for approval

- 4.1. The application for approval of a type of tyre for agricultural and forestry services shall be submitted by the holder of the trade name or mark or by his duly accredited representative. It shall specify:
 - 4.1.1. The tyre size designation as defined in paragraph 2.15. of this Regulation;
 - 4.1.2. The trade name or mark;
 - 4.1.3. The category of use as defined in paragraph 2.1.3. of this Regulation;
 - 4.1.4. The structure;
 - 4.1.5. The speed category symbol;
 - 4.1.6. The load-capacity index of the tyre, specifying in case of implement tyres that for traction (only) and that for trailer application, if applicable;

² Before 1 January 2000, the date of manufacture may be indicated by a group of three digits, the first two showing the week and the last one the year of manufacture.

- 4.1.7. Whether the tyre is to be fitted with or without an inner tube;
- 4.1.8. The supplementary service description, if applicable;
- 4.1.9. The tyre/rim configuration;
- 4.1.10. The rim to be used for measurements and the rim to be used for tests;
- 4.1.11. The rim(s) on which the tyre can be mounted;
- 4.1.12. The inflation pressure (bar or kPa) for measurements;
- 4.1.13. The factor X referred to in paragraph 2.18. or the applicable table of Annex 5;
- 4.1.14. The cold inflation pressure that shall not be exceeded for bead seating during tyre mounting, as specified by the tyre manufacturer for the tyre type;
- 4.1.15. The test pressure, in kPa (or in bar).
- 4.2. On request of the Type Approval Authority, the tyre manufacturer must also submit a complete technical file for each tyre type containing in particular sketches or photographs (three copies) to identify the tread pattern and the envelope of the inflated tyre mounted on the measuring rim showing the relevant dimensions (see paragraphs 6.1. and 6.2. below) of the component type submitted for approval. It shall also either contain the test report issued by an approved test laboratory or be accompanied by one sample of the tyre type, as requested by the Type Approval Authority.

5. Approval

- 5.1. If the type of pneumatic tyre submitted for approval in pursuance to this Regulation meets the requirements of paragraph 6. below, approval of that type of tyre shall be granted.
- 5.2. An approval number shall be assigned to each type approved; its first two digits (at present 00 for the Regulation in its original form) shall indicate the series of amendments incorporating the most recent major technical amendments made to the Regulation at the time of issue of the approval. The same Contracting Party may not assign the same number to another type of pneumatic tyre.
- 5.3. Notice of approval or extension or refusal or withdrawal of approval or production definitively discontinued of a type of pneumatic tyre pursuant to this Regulation shall be communicated to the Parties to the 1958 Agreement which apply this Regulation, by means of a form conforming to the model in Annex 1 to this Regulation.
- 5.4. There shall be affixed, conspicuously, to every pneumatic tyre conforming to a type of tyre approved under this Regulation, in the space referred to in paragraph 3.3. above and in addition to the markings prescribed in paragraphs 3.1. and 3.2. above, an international approval mark consisting of:

- 5.4.1. A circle surrounding the letter "E" followed by the distinguishing number of the country which has granted approval.³
- 5.4.2. The number of this Regulation followed by the letter "R", a dash and the type approval number.
- 5.5. The approval mark shall be clearly legible and be indelible.
- 5.6. Annex 2 to this Regulation gives an example of the arrangement of the approval mark.

6. Requirements

- 6.1. Section width of a tyre
 - 6.1.1. Except as provided by paragraph 6.1.2. below, the section width is calculated by the following formula:

$$S = S1 + K (A-A1)$$

Where:

- S is the "section width" expressed in mm related to the measuring rim;
- S1 is the "nominal section width" in mm as shown on the sidewall of the tyre in the tyre-size designation as prescribed;
- A is the width (expressed in mm)⁴ of the measuring rim, as shown by the manufacturer in the descriptive note;
- A1 is the width (expressed in mm)⁶ of the theoretical rim; it is taken to equal S1 multiplied by the factor X as specified by the tyre manufacturer;

and K is taken to equal 0.4.

- 6.1.2. However, for the types of tyre for which the size designation is given in the first column of the tables in Annex 5, the theoretical rim width (A1) and the nominal section width (S1) are given opposite the tyre size designation in those tables.
- 6.2. Outer diameter of a tyre
 - 6.2.1. Except as provided by paragraph 6.2.2., the outer diameter of a tyre is calculated by the following formula:

$$D = d + 2 H$$

Where:

- D is the outer diameter expressed in mm;
- d is the conventional number denoting the nominal rim diameter expressed in mm (see paragraph 2.16.);

³ The distinguishing numbers of the Contracting Parties to the 1958 Agreement are reproduced in Annex 3 to the Consolidated Resolution on the Construction of Vehicles (R.E.3), document ECE/TRANS/WP.29/78/Rev.2/Amend.3 - www.unece.org/trans/main/wp29/wp29wgs/wp29gen/wp29resolutions.html

⁴ Conversion factor from code to mm is 25.4.

H is the nominal section height in mm and is equal to:

$$H = 0.01 \times Ra \times S1$$

Where:

Ra is the nominal aspect ratio;

S1 is the "nominal section width" in mm.

All as shown on the sidewall of the tyre in the tyre-size designation in conformity with the requirements of paragraph 2.15.

6.2.2. However, for the types of tyres for which the size designation is given in the first column of the tables of Annex 5 the outer diameter (D) and the nominal rim diameter (d) expressed in mm are given opposite the tyre size designation in those tables.

6.3. Tyre section width: specification of tolerances

6.3.1. The overall width of a tyre may be less than the section width determined pursuant to paragraph 6.1., or shown in Annex 5;

6.3.2. The overall width of a tyre may not exceed the section width determined pursuant to paragraph 6.1. by more than the following:

Radial construction: +5 per cent

Diagonal (bias) construction: +8 per cent

6.3.3. However, for the types of tyre for which the size designation is given in the first column of the tables in Annex 5, the allowed percentages are those given in the relevant tables, if any.

6.4. Tyre outer diameter: specification of tolerances

6.4.1. The outer diameter of a tyre must not be outside the values D min and D max obtained from the following formulae:

$$D \text{ min} = d + 2 (H \times a)$$

$$D \text{ max} = d + 2 (H \times b)$$

Where "H" and "d" are as defined in paragraph 6.2.1.

6.4.1.1. For sizes listed in Annex 5: $H = 0,5 (D - d)$

(for references see paragraph 6.2. above).

6.4.2. Coefficients "a" and "b" are respectively:

Category of use	Radial		Diagonal (bias)	
	a	b	a	b
Steering wheels	0,96	1,04	0,96	1,07
Tractor drive wheels and forestry machines - normal	0,96	1,04	0,96	1,07
Tractor drive wheels and forestry machines – special	1,00	1,12	1,00	1,12
Implement	0,96	1,04	0,96	1,07

- 6.4.3. However, for the types of tyre for which the size designation is given in the first column of the tables in Annex 5, the allowed percentages are those given in the relevant tables, if any.
- 6.5. Test procedures
- 6.5.1. The actual dimensions of tyres are measured as prescribed in Annex 6.
- 6.5.2. The test procedure to assess the resistance of the tyre to burst is described in Annex 8.
- 6.5.2.1. A tyre which, after undergoing the relevant test to assess the resistance to burst, does not exhibit any tread separation, ply separation, cord separation, broken beads or broken cords is deemed to have passed the test. The tyre tested shall not be used for any other tests.
- 6.5.3. The test procedures to assess the suitability of the tyre for the claimed performances are described in Annex 9.
- 6.5.3.1. A tyre which, after undergoing the relevant load/speed test, does not exhibit any tread separation, ply separation, cord separation or broken cords is deemed to have passed the test. The tyre tested shall not be used for any other tests.
- 6.5.3.2. A tyre which, after undergoing the relevant load/speed test, does exhibit chunking, due to the specific test conditions is deemed to have passed the test.
- 6.5.4. Where a tyre manufacturer produces a range of tyres it is not considered necessary to carry out tests on every type of tyre in the range.

7. Modification of tyre type and extension of approval

- 7.1. Every modification of a tyre type shall be notified to the Type Approval Authority which approved the tyre type. That Authority may then either:
 - 7.1.1. Consider that the modifications made are unlikely to have an appreciable adverse effect and that in any case the tyre still meet the requirements; or
 - 7.1.2. Require a further test report from the Technical Service responsible for carrying out the tests.
- 7.2. A modification of the tread pattern of the tyre shall not be considered to necessitate a repetition of the tests prescribed in paragraph 6. of this Regulation.
- 7.3. Confirmation or refusal of approval, specifying the alterations, shall be communicated by the procedure specified in paragraph 5.3. above to the Parties to the Agreement which apply this Regulation.
- 7.4. The Type Approval Authority issuing the extension of approval shall assign a series number for such an extension and inform thereof the other Parties to the 1958 Agreement applying this Regulation by means of a communication form conforming to the model in Annex 1 to this Regulation.

8. Conformity of production

The conformity of production procedures shall comply with those set out in the Agreement, Appendix 2 (E/ECE/324-E/ECE/TRANS/505/Rev.2), with the following requirements:

- 8.1. The pneumatic tyres approved under this Regulation shall be so manufactured as to conform to the type approved by meeting the requirements set forth in paragraph 6. above.
- 8.2. The Type Approval Authority which has granted type approval may at any time verify the conformity control methods applied in each production facility. For each production facility, the normal frequency of these verifications shall be once every two years.

9. Penalties for non-conformity of production

- 9.1. The approval granted in respect of a type of pneumatic tyre pursuant to this Regulation may be withdrawn if the requirement laid down in paragraph 8.1. above is not complied with or if the tyres taken from the series have failed to pass the tests prescribed in that paragraph.
- 9.2. If a Party to the Agreement which applies this Regulation withdraws an approval it has previously granted, it shall forthwith so notify the other Contracting Parties which apply this Regulation, by means of a communication form conforming to the model in Annex 1 to this Regulation.

10. Production definitively discontinued

If the holder of an approval completely ceases to manufacture a type of pneumatic tyre approved in accordance with this Regulation, he shall so inform the Type Approval Authority which granted the approval. Upon receiving the relevant communication that Authority shall inform thereof the other Parties to the Agreement which apply this Regulation by means of a communication form conforming to the model in Annex 1 to this Regulation.

11. Names and addresses of Technical Services responsible for conducting approval tests, of test laboratories, and of Type Approval Authorities

- 11.1. The Parties to the Agreement which apply this Regulation shall communicate to the United Nations Secretariat the names and addresses of the Technical Services responsible for conducting approval tests and, where applicable, of the approved test laboratories and of the Type Approval Authorities which grant approval and to which forms certifying approval or refusal or withdrawal of approval, issued in other countries, are to be sent.

- 11.2. The Parties to the Agreement which apply this Regulation may use laboratories of tyre manufacturers and may designate, as approved test laboratories, those among them which are situated on their territory or on the territory of another Party to the Agreement subject to a preliminary agreement to this procedure by the competent Type Approval Authority of the latter.
- 11.3. Where a Party to the Agreement applies paragraph 11.2. above, it may, if it so desires, be represented at the tests by one or more persons of its choice.

Explanatory figure (see paragraphs 2.2. and 4.1.)

Type cross section

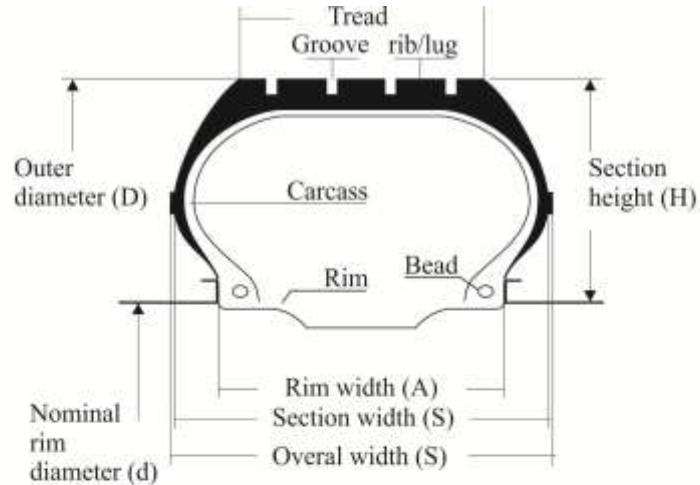

Lug (cleat) tread pattern



Circumferencial Rib tread pattern

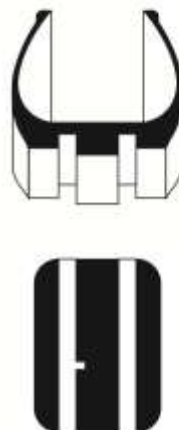

Annex 1

Communication

(Maximum format: A4 (210 x 297 mm))



issued by :

Name of administration:

.....
.....
.....

concerning:²

- Approval gr
- Approval extended
- Approval refused
- Approval withdrawn
- Production definitively discontinued

of a type of pneumatic tyre for motor vehicles pursuant to Regulation No. 106

Approval No.:

Extension No. :

1. Manufacturer's name or trade mark (s) of the tyre:
2. Tyre type designation by the manufacturer:
3. Manufacturer's name and address:
4. If applicable, name and address of manufacturer's representative:
.....
5. Summarized description:
- 5.1. Size of tyre:
- 5.2. Category of use:
- 5.3. Structure: diagonal (bias-ply)/bias belted/radial²
- 5.4. Speed category symbol:
- 5.5. Load-capacity index:

¹ Distinguishing number of the country which has granted/extended/refused/withdrawn approval (see approval provisions in the Regulation).

² Strike out what does not apply.

- 5.5.1. For traction (implement only):
- 5.5.2. For trailer (implement only):.....
- 5.6. Whether the tyre is to be fitted with or without an inner tube.....
.....
- 5.7. The supplementary service description, if applicable:
.....
6. Technical Service and, where applicable, test laboratory approved for purposes
of approval or of verification of conformity:
7. Date of report issued by that Service:
8. Number of report issued by that Service:
9. Reason(s) of extension (if applicable):
10. Any remarks:.....
.....
11. Place:.....
12. Date:.....
13. Signature:
14. Annexed to this communication is a list of documents in the approval file deposited
at the Type Approval Authorities having delivered the approval and which can be
obtained upon request

Annex 2

Arrangement of approval mark

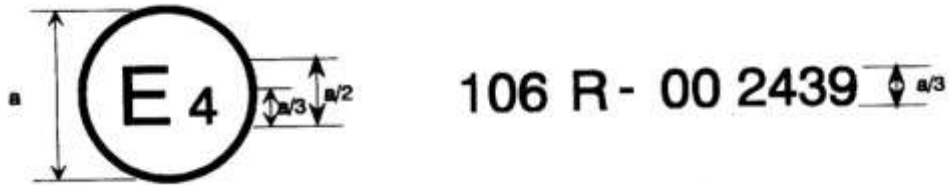

$a = 12 \text{ mm min}$

The above approval mark affixed to a pneumatic tyre shows that the type of tyre concerned has been approved in the Netherlands (E 4) pursuant to Regulation No. 106 under approval number 002439. The first two digits of the approval number indicate that the approval was granted in accordance with the requirements of Regulation No. 106 in its original form.

Note: The approval number must be placed close to the circle and either above or below the "E" or to the left or right of that letter. The digits of the approval number must be on the same side of the "E" and face in the same direction. The use of Roman numerals as approval numbers should be avoided so as to prevent any confusion with other symbols.

Annex 3

Arrangement of tyre markings

(See paragraphs 3.1. and 3.2. of this Regulation)

Part A: Drive wheel tyres for agricultural tractors

Example of the markings to be borne by types of tyres complying with this Regulation

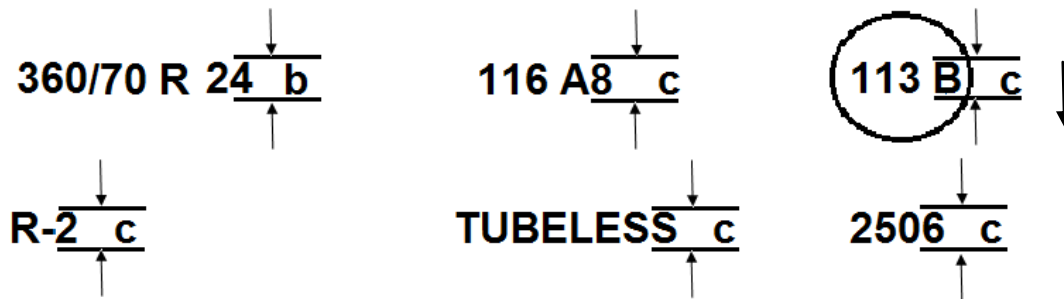

Minimum heights of markings (mm)

Tyres of nominal section width	Tyres of rim diameter code		
	Up to 12	13 to 19.5	20 and above
up to 130	b = 4 c = 4	b = 6 c = 4	b = 9 c = 4
135 to 235	b = 6 c = 4	b = 6 c = 4	b = 9 c = 4
240 and above	b = 9 c = 4	b = 9 c = 4	b = 9 c = 4

These markings define a drive wheel tyre:

- Having a nominal section width of 360;
- Having a nominal aspect ratio of 70;
- Of radial ply structure (R);
- Having a nominal rim diameter of 610 for which the code is 24;
- Having a load capacity of 1250 kg, corresponding to load index 116 in Annex 4;
- Classified in the speed category A8 (reference speed 40 km/h);
- Allowed to be used additionally at 50 km/h (speed category symbol B) with a load, capacity of 1150 kg corresponding to the load capacity index 113 shown in Annex 4;
- For fitting without an inner tube ("tubeless");
- Having a special tread ("R-2");

- (j) Manufactured during the twenty-fifth week of the year 2006 (see paragraph 3.2. of this Regulation).

The positioning and order of the markings constituting the tyre designation are as follows:

- (a) The size designation, comprising the prefix (if any), the nominal section width, the nominal aspect ratio, the type-of-structure symbol (where applicable) and the nominal rim diameter, must be grouped as shown in the examples:
360/70 R 24, IF 360/70 R 24, VF 360/70 R 24, IF 800/65 R 32 CFO, 800/70 R 24 CHO;
- (b) The service description (load index and the speed category symbol) is placed near the size designation. It may either precede or follow it or be placed above or below it;
- (c) The symbols "TUBELESS", "R-2" or "DEEP", the optional word "RADIAL" and the date of production may be at a distance from the size designation;
- (d) The marking of the additional service description inside the circle may show either the speed category symbol after or below the load index.

Part B: Steering wheel tyres for agricultural and forestry tractors

Example of the markings to be borne by types of tyres complying with this Regulation

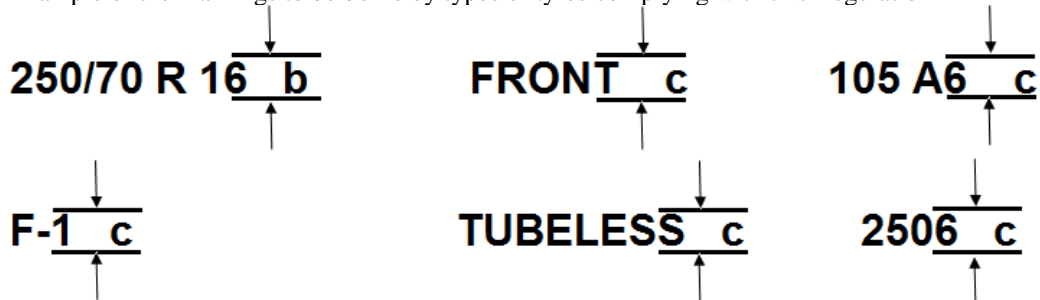

Minimum heights of markings (mm)

Tyres of nominal section width	Tyres of rim diameter code		
	Up to 12	13 to 19.5	20 and above
up to 130	b = 4 c = 4	b = 6 c = 4	b = 9 c = 4
135 to 235	b = 6 c = 4	b = 6 c = 4	b = 9 c = 4
240 and above	b = 9 c = 4	b = 9 c = 4	b = 9 c = 4

These markings define a steering wheel tyre:

- (a) Having a nominal section width of 250;
(b) Having a nominal aspect ratio of 70;

- (c) Of radial-ply structure (R);
- (d) Having a nominal rim diameter of 405 mm, for which the code is 16, designed for the equipment of non-driven steering axles of agricultural tractors (FRONT);
- (e) Having load capacities of 925 kg, corresponding to the load capacity index 105 shown in Annex 4;
- (f) Classified in the nominal speed category A6 (reference speed 30 km/h);
- (g) For fitting without an inner tube "tubeless"; and
- (h) Manufactured during the twenty-fifth week of the year 2006 (see paragraph 3.2. of this Regulation).

The positioning and order of the markings constituting the tyre designation are as follows:

- (a) The size designation, comprising the nominal section width, the nominal aspect ratio, the type-of-structure symbol (where applicable), the nominal rim diameter and, optionally the letters "FRONT", must be grouped as shown in the above example: 250/70 R 16 FRONT;
- (b) The service description (the load index and the speed category symbol) is placed together near the size designation. It may either precede or follow it or be placed above or below it;
- (c) The symbol "TUBELESS", the optional word "RADIAL", the optional symbol "F-1", and the date of manufacture may be at a distance from the size designation.

Part C: Implement tyres

Example of the markings to be borne by types of tyres complying with this Regulation

250/70 R 20 IMP

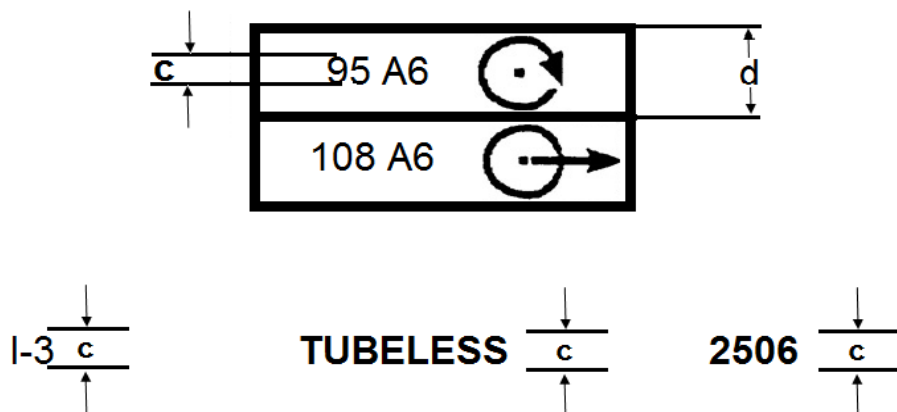

Minimum heights of markings (mm)

<i>Tyres of nominal section width</i>	<i>Tyres of rim diameter code</i>
---------------------------------------	-----------------------------------

	<i>Up to 12</i>	<i>13 to 19.5</i>	<i>20 and above</i>
up to 130	b = 4 c = 4 d = 7	b = 6 c = 4 d = 12	b = 9 c = 4 d = 12
135 to 235	b = 6 c = 4 d = 12	b = 6 c = 4 d = 12	b = 9 c = 4 d = 12
240 and above	b = 9 c = 4 d = 12	b = 9 c = 4 d = 12	b = 9 c = 4 d = 12

These markings define an implement tyre:

- (a) Having a nominal section width of 250;
- (b) Having a nominal aspect ratio of 70;
- (c) Of radial-ply structure (R);
- (d) Having a nominal rim diameter of 508 mm, for which the code is 20;
- (e) Designed primarily for the equipment of implements, agricultural machinery or agricultural trailers (IMP);
- (f) Having load capacities of 690 kg corresponding to the load capacity index 95 shown in Annex 4 when used on driven axles (traction application), as identified by the appropriate symbol;
- (g) Having load capacities of 1,000 kg when used on non-driven axles (trailer application) corresponding to the load capacity index 108 shown in Annex 4, as identified by the appropriate symbol;
- (h) Both applications being classified in the nominal speed category A6 (reference speed 30 km/h);
- (i) For fitting without an inner tube "tubeless"; and
- (j) Manufactured during the twenty-fifth week of the year 2006 (see paragraph 3.2. of the Regulation).

The positioning and order of the markings constituting the tyre designation are as follows:

- (a) The size designation, comprising the nominal section width, the nominal aspect ratio, the type-of-structure symbol (where applicable), the nominal rim diameter and optionally the letters 'IMP' must be grouped as shown in the above example: 250/70 R 20 IMP;
- (b) The service description (the load index and the speed category symbol) and the relevant type of application symbol are placed together near the size designation. They may either precede or follow it or be placed above or below it;
- (c) The symbol "TUBELESS", I-3 if any, the optional word "RADIAL", the optional word "IMPLEMENT" and the date of manufacture may be at a distance from the size designation.

Part D: Tyres for forestry machines

Example of the markings to be borne by types of tyres complying with this Regulation

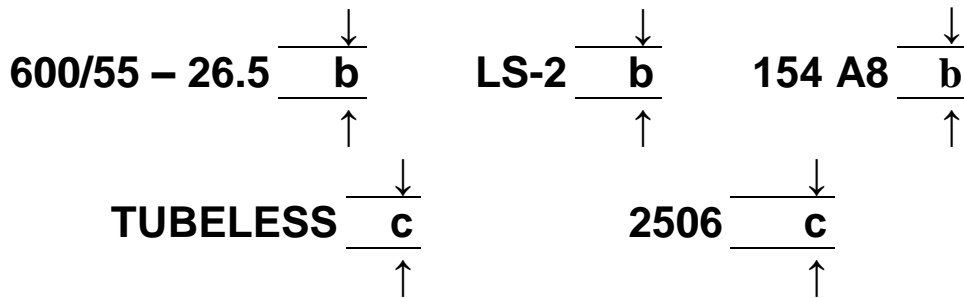

Minimum heights of markings: b: 9 mm c: 4 mm

These markings define a tyre for forestry machines (LS):

- (a) Having a nominal section width of 600;
- (b) Having a nominal aspect ratio of 55;
- (c) Of diagonal ply structure (-);
- (d) Having a nominal rim diameter of 673 mm for which the code is 26.5;
- (e) Having an intermediate tread ("LS-2");
- (f) Having a load capacity of 3750 kg, corresponding to load index 154 in Annex 4;
- (g) Classified in the speed category A8 (reference speed 40 km/h);
- (h) For fitting without an inner tube ("tubeless");
- (i) Manufactured during the twenty-fifth week of the year 2006 (see paragraph 3.2. of this Regulation).

The positioning and order of the markings constituting the tyre designation are as follows:

- (a) The size designation, comprising the nominal section width, the nominal aspect ratio, the type of structure symbol (where applicable) and the nominal rim diameter, must be grouped as shown in the above example: 600/55 - 26.5;
- (b) The inscription "LS", followed by the number 1, 2, 3 or 4 as appropriate, is placed after the size designation, as shown in the above example: LS-2;
- (c) The service description (load index and the speed category symbol) is placed near the size designation. It may either precede or follow it or be placed above or below it;
- (d) The symbols "TUBELESS" and the date of production may be at a distance from the size designation.

Annex 4

List of load capacity indices (LI) and corresponding maximum mass to be carried (kg)

(See paragraph 2.28. of this Regulation)

<i>LI</i>	<i>kg</i>	<i>LI</i>	<i>kg</i>	<i>LI</i>	<i>kg</i>	<i>LI</i>	<i>kg</i>
1	46,2	51	195	101	825	151	3 450
2	47,5	52	200	102	850	152	3 550
3	48,7	53	206	103	875	153	3 650
4	50	54	212	104	900	154	3 750
5	51,5	55	218	105	925	155	3 875
6	53	56	224	106	950	156	4 000
7	54,5	57	230	107	975	157	4 125
8	56	58	236	108	1 000	158	4 250
9	58	59	243	109	1 030	159	4 375
10	60	60	250	110	1 060	160	4 500
11	61,5	61	257	111	1 090	161	4 625
12	63	62	265	112	1 120	162	4 750
13	65	63	272	113	1 150	163	4 875
14	67	64	280	114	1 180	164	5 000
15	69	65	290	115	1 215	165	5 150
16	71	66	300	116	1 250	166	5 300
17	73	67	307	117	1 285	167	5 450
18	75	68	315	118	1 320	168	5 600
19	77,5	69	325	119	1 360	169	5 800
20	80	70	335	120	1 400	170	6 000
21	82,5	71	345	121	1 450	171	6 150
22	85	72	355	122	1 500	172	6 300
23	87,5	73	365	123	1 550	173	6 500
24	90	74	375	124	1 600	174	6 700
25	92,5	75	387	125	1 650	175	6 900
26	95	76	400	126	1 700	176	7 100
27	97,5	77	412	127	1 750	177	7 300
28	100	78	425	128	1 800	178	7 500
29	103	79	437	129	1 850	179	7 750
30	106	80	450	130	1 900	180	8 000
31	109	81	462	131	1 950	181	8 250
32	112	82	475	132	2 000	182	8 500
33	115	83	487	133	2 060	183	8 750
34	118	84	500	134	2 120	184	9 000
35	121	85	515	135	2 180	185	9 250
36	125	86	530	136	2 240	186	9 500
37	128	87	545	137	2 300	187	9 750
38	132	88	560	138	2 360	188	10 000
39	136	89	580	139	2 430	189	10 300
40	140	90	600	140	2 500	190	10 600
41	145	91	615	141	2 575	191	10 900
42	150	92	630	142	2 650	192	11 200
43	155	93	650	143	2 725	193	11 500
44	160	94	670	144	2 800	194	11 800
45	165	95	690	145	2 900	195	12 150
46	170	96	710	146	3 000	196	12 500
47	175	97	730	147	3 075	197	12 850
48	180	98	750	148	3 150	198	13 200
49	185	99	775	149	3 250	199	13 600
50	190	100	800	150	3 350	200	14 000

Annex 5

Theoretical rim, outer diameter and nominal section width of tyres of certain size designations

Table 1 (1 of 2)
Agricultural steering wheels - Normal and low Section sizes

<i>Tyre size designation</i>	<i>Theoretical rim width code (A1)</i>	<i>Nominal width (S1) (mm)</i>	<i>Overall diameter (D) (mm)</i>	<i>Nominal width (d) (mm)</i>
4.00 - 9	3	112	460	229
4.00 - 12	3	112	535	305
4.00 - 15	3	112	610	381
4.00 - 16	3	112	630	406
4.00 - 19	3	112	712	483
4.50 - 10	3	121	505	254
4.50 - 16	3	122	655	406
4.50 - 19	3	122	736	483
5.00 - 10	3	130	530	254
5.00 - 12	3	130	580	305
5.00 - 15	4	140	655	381
5.00 - 16	4	140	680	406
5.50 - 16	4	150	710	406
6.00 - 14	5	169	688	356
6.00 - 16	4,5	165	735	406
6.00 - 18	4	160	790	457
6.00 - 19	4,5	165	814	483
6.00 - 20	4,5	165	840	508
6.50 - 10	4,5	175	608	254
6.50 - 16	4,5	175	760	406
6.50 - 20	4,5	175	865	508
7.50 - 16	5,5	205	805	406
7.50 - 18	5,5	205	860	457
7.50 - 20	5,5	205	915	508
8.00 - 16	5,5	211	813	406
9.00 - 16	6	234	855	406
9.50 - 20	7	254	978	508
10.00 - 16	8	274	895	406
11.00 - 16	10	315	965	406
11.00 - 24	10	315	1 170	610

Table 1 (2 of 2)
Agricultural steering wheels - Normal and low section sizes

<i>Tyre size designation</i>	<i>Theoretical rim width code (A1)</i>	<i>Nominal width (S1) (mm)</i>	<i>Overall diameter (D) (mm)</i>	<i>Nominal width (d) (mm)</i>
Low Section				
7.5L - 15	6	210	745	381
8.25/85 - 15	6	210	745	381
9.5L - 15	8	240	785	381
9.5/85 - 15	8	240	785	381
11L - 15	8	280	815	381
11.5/75 - 15	8	280	815	381
7.5L - 16	6	208	746	406
11L - 16	8	279	840	406
14L - 16.1	11	360	985	409
14.0/80 - 16.1	11	360	985	409
14.5/75 - 16.1	11	373	940	409
16.5L - 16.1	14	419	1 072	409

Notes:

1. Agricultural steering wheels tyres are identified either by suffix "Front" placed after the Tyre size designation (e.g. 4.00 - 9 Front) or by one of the following additional markings added to the Tyre sidewalls: "F - 1" or "F - 2".
2. Tyres of radial structure are identified by means of the letter "R" in place of " - " (e.g. 4.00R9)

Table 2 (1 of 5)
Drive wheel tyres for agricultural tractors - Normal section sizes

Tyre size designation	Theoretical rim width code (A1)	Nominal section width (S1) (mm)		Overall diameter (D) (mm)		Nominal rim diameter (d) (mm)
		Radial	Diagonal	Radial	Diagonal	
4.00-7	3		112		410	178
4.00-8	3		112		435	203
4.00-9	3		112		460	229
4.00-10	3		112		485	254
4.00-12	3		112		535	305
4.00-18	3		112		690	457
4.50-10	3		121		505	254
5.0 -10	4		135		505	254
5.00-10	3		130		530	254
5.00-12	4		145		580	305
5.00-15	4		145		645	381
6.00-12	4		160		635	305
6.00-16	4		160		735	406
6.5-15	5		167		685	381
6.50-16	5		175		760	406
7.50-18	5,5		205		860	457
8.00-20	6		220		965	508
5-12	4		127		545	305
5-14	4		127		595	356
5-26	4		127		900	660
6-10	5		157		550	254
6-12	5		157		600	305
6-14	5		157		650	356
7-14	5		173		690	356
7-16	6		183		740	406
8-16	6		201		790	406
8-18	7		211		840	457
7.2-20	6		183		845	508
7.2-24	6		183		945	610
7.2-30	6		183		1 095	762
7.2-36	6		183		1 250	914
7.2-40	6		183		1 350	1 016
8.3-16	7		211		790	406

Table 2 (2 of 5)
Drive wheel tyres for agricultural tractors - Normal section sizes

Tyre size designation	Theoretical rim width code (A1)	Nominal section width (S1) (mm)		Overall diameter (D) (mm)		Nominal rim diameter (d) (mm)
		Radial	Diagonal	Radial	Diagonal	
8.3-20	7		211		890	508
8.3-22	7		211		940	559
8.3-24	7	211	211	985	995	610
8.3-26	7		211		1 045	660
8.3-28	7		211		1 095	711
8.3-32	7	211	211	1 190	1 195	813
8.3-36	7	211	211	1 290	1 300	914
8.3-38	7		211		1 350	965
8.3-42	7	211	211	1 440	1 450	1 067
8.3-44	7	211	211	1 495	1 500	1 118
9.5-16	8		241		845	406
9.5-18	8		241		895	457
9.5-20	8	241	241	940	945	508
9.5-22	8		241		995	559
9.5-24	8	241	241	1 040	1 050	610
9.5-26	8		241		1 100	660
9.5-28	8	241		1 140		711
9.5-32	8		241		1 250	813
9.5-36	8	241	241	1 345	1 355	914
9.5-38	8		241		1 405	965
9.5-42	8		241		1 505	1 067
9.5-44	8	241	241	1 550	1 555	1 118
9.5-48	8	241	241	1 650	1 655	1 219

Table 2 (3 of 5)
Drive wheel tyres for agricultural tractors - Normal section sizes

Tyre size designation	Theoretical rim width code (A1)	Nominal section width (S1) (mm)		Overall diameter (D) (mm)		Nominal rim diameter (d) (mm)
		Radial	Diagonal	Radial	Diagonal	
11.2-18	10		284		955	457
11.2-20	10	284	284	995	1 005	508
11.2-24	10	284	284	1 095	1 105	610
11.2-26	10		284		1 155	660
11.2-28	10	284	284	1 200	1 205	711
11.2-36	10	284	284	1 400	1 410	914
11.2-38	10	284	284	1 455	1 460	965
11.2-42	10	284		1 555		1 067
11.2-44	10	284		1 610		1 118
11.2-48	10	284		1 710		1 219
12.4-16	11		315		956	406
12.4-20	11	315		1 045		508
12.4-24	11	315	315	1 145	1 160	610
12.4-26	11		315		1 210	660
12.4-28	11	315	315	1 250	1 260	711
12.4-30	11		315		1 310	762
12.4-32	11	315	315	1 350	1 360	813
12.4-36	11	315	315	1 450	1 465	914
12.4-38	11	315	315	1 500	1 515	965
12.4-42	11		315		1 615	1 067
12.4-46	11	315		1 705		1 168
12.4-52	11	315		1 860		1 321
13.6-16	12		345		1 005	406
13.6-24	12	345	345	1 190	1 210	610
13.6-26	12	345	345	1 260	1 260	660
13.6-28	12	345	345	1 295	1 310	711
13.6-36	12	345	345	1 500	1 515	914
13.6-38	12	345	345	1 550	1 565	965
13.6-48	12	345		1 805		1 219
13.9-36	12		353		1 478	965
14.9/80-24	12		368		1 215	610
14.9-20	13		378		1 165	508
14.9-24	13	378	378	1 245	1 265	610
14.9-26	13	378	378	1 295	1 315	660
14.9-28	13	378	378	1 350	1 365	711
14.9-30	13	378	378	1 400	1 415	762

Table 2 (4 of 5)

Drive wheel tyres for agricultural tractors - Normal section sizes

Tyre size designation	Theoretical rim width code (A1)	Nominal section width (S1) (mm)		Overall diameter (D) (mm)		Nominal rim diameter (d) (mm)
		Radial	Diagonal	Radial	Diagonal	
14.9-38	13	378	378	1 600	1 615	965
14.9-46	13	378		1 824		1 168
15.5-38	14	394	394	1 565	1 570	965
16.9-24	15	429	429	1 320	1 335	610
16.9-26	15	429	429	1 370	1 385	660
16.9-28	15	429	429	1 420	1 435	711
16.9-30	15	429	429	1 475	1 485	762
16.9-34	15	429	429	1 575	1 585	864
16.9-38	15	429	429	1 675	1 690	965
16.9-42	15	429		1 775		1 067
18.4-16.1	16		467		1 137	409
18.4-24	16	467	467	1 395	1 400	610
18.4-26	16	467	467	1 440	1 450	660
18.4-28	16	467	467	1 490	1 501	711
18.4-30	16	467	467	1 545	1 550	762
18.4-34	16	467	467	1 645	1 650	864
18.4-38	16	467	467	1 750	1 750	965
18.4-42	16	467	467	1 850	1 850	1 067
18.4-46	16	467		1 958		1 168

Table 2 (5 of 5)
Drive wheel tyres for agricultural tractors - Normal and low section sizes

Tyre size designation	Theoretical rim width code (AI)	Nominal section width (SI) (mm)		Overall diameter (D) (mm)		Nominal rim diameter (d) (mm)
		Radial	Diagonal	Radial	Diagonal	
20.8-34	18	528	528	1 735	1 735	864
20.8-38	18	528	528	1 835	1 835	965
20.8-42	18	528	528	1 935	1 935	1 067
23.1-26	20	587	587	1 605	1 605	660
23.1-30	20	587	587	1 700	1 705	762
23.1-34	20	587	587	1 800	1 805	864
24.5-32	21	622	622	1 800	1 805	813
Low section height						
7.5L-15	6		210		745	381
14.9LR-20	13	378		1 100		508
17.5L-24	15	445	445	1 241	1 265	610
19.5L-24	17	495	495	1 314	1 339	610
21L-24	18		533		1 402	610
28.1-26	25		714		1 615	660
28L-26	25	719	714	1 607	1 615	660
30.5L-32	27	775	775	1 820	1 820	813

Notes:

1. The Tyre size designation may be supplemented by an additional figure: ex: 23.1/18 26 instead of 23.1 - 26.
2. Tyres of radial structure are identified by means of the letter "R" in place of " - " (e.g. 23.1R26).
3. Coefficient for the calculation of the overall width: +8 per cent.

Table 3
Drive wheel tyres for agricultural tractors - Low section series

<i>Tyre size designation</i>	<i>Theoretical rim width code (AI)</i>	<i>Nominal section width (SI) (mm)</i>	<i>Overall diameter (D) (mm)</i>	<i>Nominal rim diameter (d) (mm)</i>
11.2/78-28	10	296	1 180	711
12.4/78-28	11	327	1 240	711
12.4/78-36	11	327	1 440	914
13.6/78-28	12	367	1 285	711
13.6/78-36	12	367	1 490	914
14.9/78-28	13	400	1 345	711
16.9/78-28	15	452	1 410	711
16.9/78-30	15	452	1 460	762
16.9/78-34	15	452	1 560	864
16.9/78-38	15	452	1 665	965
18.4/78-30	16	490	1 525	762
18.4/78-38	16	490	1 730	965

Table 4
Drive wheel tyres for agricultural tractors - Low section series

<i>Tyre size designation</i>	<i>Theoretical rim width code (A1)</i>	<i>Nominal section width (S1) (mm)</i>	<i>Overall diameter (D) (mm)</i>	<i>Nominal rim diameter (d) (mm)</i>
300/70R20	9	295	952	508
320/70R20	10	319	982	508
320/70R24	10	319	1 094	610
320/70R28	10	319	1 189	711
360/70R20	11	357	1 042	508
360/70R24	11	357	1 152	610
360/70R28	11	357	1 251	711
380/70R20	12	380	1 082	508
380/70R24	12	380	1 190	610
380/70R28	12	380	1 293	711
420/70R24	13	418	1 248	610
420/70R28	13	418	1 349	711
420/70R30	13	418	1 398	762
480/70R24	15	479	1 316	610
480/70R26	15	479	1 372	660
480/70R28	15	479	1 421	711
480/70R30	15	479	1 478	762
480/70R34	15	479	1 580	864
480/70R38	15	479	1 681	965
520/70R26	16	516	1 456	660
520/70R30	16	516	1 536	762
520/70R34	16	516	1 640	864
520/70R38	16	516	1 749	965
580/70R38	18	577	1 827	965

Table 5 (1 of 3)
Agricultural implement tyres - Normal section sizes

Tyre size designation	Theoretical rim width code (A1)	Nominal section width (S1) (mm)	Overall diameter (D) (mm)		Nominal rim diameter (d) (mm)
				(*)	
125 - 15 IMP	3,5	127	590		381
140 - 6 IMP	4,5	135	315		152
165 - 15 IMP	4,5	167	650		381
190-8 IMP	5.50	182	430		203
2.50 - 4 IMP	1,75	68	225		102
2.75 - 4 IMP	1,75	70	234		102
2.50 - 8 IMP	1,5	68	338		203
3.00 - 4 IMP	2,5	90	265		102
3.00 - 8 IMP	2,5	90	367		203
3.00 - 10 IMP	2,5	90	418		254
3.25 - 8 IMP	2,10	84	366		203
3.25 - 16 IMP	1,85	88	590		406
3.50 - 5 IMP	3	95	292		127
3.50 - 6 IMP	2,5	100	343		152
3.50 - 8 IMP	2,5	100	393		203
3.50 - 16 IMP	1,85	92	590		406
4.00 - 4 IMP	3	114	313		102
4.00 - 5 IMP	3	102	310		127
4.00 - 6 IMP	3	114	374		152
4.00 - 8 IMP	3	112	418	425	203
4.00 - 9 IMP	3	112	443	460	229
4.0 - 10 IMP	3	114	455	465	254
4.00 - 10 IMP	3	114	465	475	254
4.00 - 12 IMP	3	112	519	536	305
4.00 - 15 IMP	3	112	595	612	381
4.00 - 16 IMP	3	114	618		406
4.00 - 18 IMP	3	112	672	688	457
4.50 - 19 IMP	3	124	720	733	483
4.00 - 21 IMP	3	112	765		533
4.00/4.50 - 21 IMP	3	110	765		533
4.10 - 4 IMP	3,25	102	268		102
4.10 - 6 IMP	3,25	102	319		152
4.10/3.50-4 IMP	2.10	89	272		101
4.50 - 9 IMP	3	124	466		229
4.50 - 14 IMP	3	124	593		356
4.50 - 16 IMP	3	123	647		406
4.50 - 19 IMP	3	124	720		483
4.80 - 8 IMP	3,75	121	423	449	203
5.00 - 8 IMP	4	145	467		203

Table 5 (2 of 3)
Agricultural implement tyres - Normal section sizes

Tyre size designation	Theoretical rim width code (A1)	Nominal section width (S1) (mm)	Overall diameter (D) (mm)		Nominal rim diameter (d) (mm)
				(*)	
5.00 - 9 IMP	3,5	141	497		229
5.0 - 10 IMP	4	145	505	517	254
5.0 - 12 IMP	4	145	566		305
5.00 - 12 IMP	4	145	567	580	305
5.00 - 14 IMP	4	145	618	631	356
5.0 - 15 IMP	4	145	642		381
5.00 - 15 IMP	3	130	639	655	381
5.00 - 16 IMP	4	145	669		406
5.00/5.25 - 21 IMP	3	136	824		533
5.50 - 16 IMP	4	150	685	703	406
5.70 - 12 IMP	4,5	146	570		305
5.70 - 15 IMP	4,5	146	647		381
5.90 - 15 IMP	4	150	665	681	381
6 - 6 IMP	4	145	425		152
6.00 - 9 IMP	4,5	169	543	556	229
6 - 12 IMP	5	145	585		305
6.0 - 12 IMP	5	155	569		305
6.00 - 12 IMP	5	152	579		305
6.00 - 16 IMP	4	158	712	729	406
6.00 - 20 IMP	4,5	169	830		508
6.40 - 15 IMP	4,5	163	684		381
6.5 - 15 IMP	5	163	674		381
6.50 - 10 IMP	5	178	597		254
6.50 - 16 IMP	4,5	173	735	754	406
6.50 - 20 IMP	5	176	850		508
6.70 - 15 IMP	4,5	182	704	720	381
6.90 - 9 IMP	5,5	175	545		229
7.00 - 12 IMP	5	187	667	685	305
7.00 - 14 IMP	5	170	691		356
7.00 - 15 IMP	5,5	200	744		381
7.00 - 16 IMP	5,5	200	769		406
7.00 - 18 IMP	5,5	200	820		457
7.00 - 19 IMP	5,5	200	845		483
7.50 - 10 IMP	6	214	634	649	254
7.50 - 14 IMP	5,5	194	686		356
7.50 - 15 IMP	6	215	808		381
7.50 - 16 IMP	5,5	202	785	801	406
7.50 - 18 IMP	5,5	202	836	852	457

Table 5 (3 of 3)
Agricultural implement tyres - Normal section sizes

Tyre size designation	Theoretical rim width code (A1)	Nominal section width (S1) (mm)	Overall diameter (D) (mm)		Nominal rim diameter (d) (mm)
				(*)	
7.50 – 20 IMP	5,5	202	887	903	508
7.50 – 24 IMP	5,5	202	989	1013	610
7.60 – 15 IMP	5,5	193	734	751	381
8 - 16 IMP	6	211	795		406
8.00 - 12 IMP	5	214	710		305
8.00 - 19 IMP	6	214	888		483
8.00 - 20 IMP	6	214	945		508
8.25 - 15 IMP	6,5	237	835		381
8.25 - 16 IMP	6	229	832		406
8.25 - 20 IMP	6	229	934		508
9.00 - 10 IMP	6	234	696		254
9.00 - 13 IMP	5,5	247	814		330
9.00 - 15 IMP	5,5	247	850		381
9.00 - 16 IMP	6	234	848		406
9.00 - 24 IMP	8	272	1 094		610
10.00 - 12 IMP	6,5	262	790		305
10.00 - 15 IMP	8	274	853		381
10.00 - 16 IMP	8	274	895		406
10.50 - 16 IMP	6,5	280	955		406
11.00 - 12 IMP	6,5	277	835		305
11.00 - 16 IMP	6,5	277	937		406
11.0 - 20 IMP	9	285	950		508
11.25 - 24 IMP	10	325	1 171		610
11.25 - 28 IMP	10	325	1 273		711
11.5 - 24 IMP	10	305	1 070		610
13.50 – 16.1 IMP	11	353	1021	1043	409
14.0 - 24 IMP	12	370	1 170		610
15.0 - 24 IMP	13	400	1 210		610
15.0 - 28 IMP	13	400	1 310		711
17.0 - 28 IMP	15	455	1 390		711
17.0 - 30 IMP	15	455	1 440		762
18.5 - 34 IMP	16	490	1 600		864
20 - 20 IMP	14	520	1 270		508

Notes:

1. The suffix "IMP" may be replaced by the wording "IMPLEMENT" on the tyre sidewall.
2. Tyres of radial structure are identified by means of the letter "R" in place of "-" (e.g. 7.5 L R 15).
3. Overall diameters (D) in column (*) apply to tyres marked with classification code "I-3" – see paragraph 3.1.8.2. of this Regulation.

Table 6 (1 of 3)
Agricultural implement tyres - Low section sizes

Tyre size designation	Theoretical rim width code (AI)	Nominal section width (S1) (mm)	Overall diameter (D) (mm)		Nominal rim diameter (d) (mm)
				(*)	
7.5 L - 15 IMP	6	210	745		381
8.5L - 14 IMP	6	216	721	735	356
9.5L - 14 IMP	7	241	741	757	356
9.5L - 15 IMP	7	241	767	782	381
11L - 14 IMP	8	279	752	770	356
11L - 15 IMP	8	279	777	796	381
11L - 16 IMP	8	279	803	821	406
12.5L - 15 IMP	10	318	823	845	381
12.5L - 16 IMP	10	318	848	870	406
14L - 16.1 IMP	11	356	940		409
16.5L - 16.1 IMP	14	419	1024	1046	409
19 L - 16.1 IMP	16	483	1 087		409
21.5 L - 16.1 IMP	18	546	1 130		409

Notes:

1. The suffix "IMP" may be replaced by the wording "IMPLEMENT" on the Tyre sidewall.
2. Tyres of radial structure are identified by means of the letter "R" in place of " - " (e.g. 7.5 LR 15).

Table 6 (2 of 3)
Agricultural implement tyres - Low section sizes

Tyre size designation	Theoretical rim width code (A1)	Nominal section width (S1) (mm)	Overall diameter (D) (mm)		Nominal rim diameter (d) (mm)
				(*)	
205/50 - 10 IMP	7	211	450		254
19.0/45 - 17 IMP	16	491	866		432
15.0/55 - 17 IMP	13	391	850	872	432
10.5/65 - 16 IMP	9	274	755		40
11.0/60 - 16 IMP	9	281	742		406
11.0/65 - 12 IMP	9	281	670	692	305
13.0/65 - 18 IMP	11	336	890		457
13.0/70 - 16 IMP	11	337	890		406
14.0/65 - 16 IMP	11	353	870		406
9.0/70 - 16 IMP	7	226	725		406
11.5/70 - 16 IMP	9	290	815		406
11.5/70 - 18 IMP	9	290	865		457
15.0/70 - 18 IMP	13	391	990		457
16.0/70 - 20 IMP	14	418	1075	1097	508
16.5/70 - 22.5 MP	13	417	1 158		572
20.0/70 - 508 IMP	16	508	1 220		508
8.0/75 - 15 IMP	6,5	199	710		381
9.0/75 - 16 IMP	7	226	749	770	406
10.0/75 - 12 IMP	9	264	685		305
10.0/75 - 15.3 IMP	9	264	760	780	389
10.0/75 - 15.3 IMP	9	264	760		389
10.0/75 - 16 IMP	9	264	805		406
12.0/75 - 18 IMP	9	299	915	937	457
13.0/75 - 16 IMP	11	336	900		406
13.5/75 - 430.9 MP	11	345	945		431
14.5/75 - 20 IMP	12	372	1 060		508
6.5/80 - 12 IMP	5	163	569	588	305
6.5/80 - 15 IMP	5	163	645	663	381
8.50 - 12 IMP	7	235	715		305
10.0/80 - 12 IMP	9	264	710	730	305
10 - 18 IMP	9	260	875		457
10.5/80 - 18 IMP	9	274	885	907	457
11.5/80 - 15.3 IMP	9	290	845	867	389
11.5/80 - 15.3 IMP	9	290	845		389
12.5/80 - 15.3 IMP	9	307	889		389
12.5/80 - 18 IMP	9	308	965	987	457
14.5/80 - 18 IMP	12	372	1060	1082	457

Table 6 (3 of 3)
Agricultural implement tyres - Low section sizes

Tyre size designation	Theoretical rim width code (A1)	Nominal section width (S1) (mm)	Overall diameter (D) (mm)		Nominal rim diameter (d) (mm)
				(*)	
15.5/80 - 24 IMP	13	394	1240	1262	610
17.0/80 - 508 IMP	13	426	1200		508
19.5/80 - 20 IMP	16	499	1300		508
21.0/80 - 20 IMP	16	525	1362		508
5.5/85 - 9 IMP	4	145	475		229
10.5/85 - 15.3 IMP	9	274	792		389
13.5/85 - 28 IMP	11	345	1293		711
16.5/85 - 24 IMP	13	417	1322	1344	610
16.5/85 - 28 IMP	13	417	1423	1445	711

Notes:

1. The suffix "IMP" may be replaced by the wording "IMPLEMENT" on the Tyre sidewall.
2. Tyres of radial structure are identified by means of the letter "R" in place of " - " (e.g. 205/50R10).
3. Overall diameters (D) in column (*) apply to tyres marked with classification code "I-3" – see paragraph 3.1.8.2. of this Regulation.

Table 7 (1 of 4)
Agricultural high flotation tyres

<i>Tyre size designation</i>	<i>Theoretical rim width code (A1)</i>	<i>Nominal section width (S1) (mm)</i>	<i>Overall diameter (D) (mm)</i>	<i>Nominal rim diameter (d) (mm)</i>
9x3.50 - 4	2,75	91	229	101
11x4.00 - 4	3,25	102	280	101
11x4.00 - 5	3	104	272	127
11x7 - 4	6	185	270	101
12x4.00 - 5	3	112	298	127
13x5.00 - 6	3,5	122	320	152
13x6.00-6	5	154	330	152
13x6.00 - 8	5	154	330	203
13x6.50 - 6	5	163	330	152
14x4.50-6	3,5	113	356	152
14x5.00 - 6	4	127	347	152
14x6.00 - 6	4,5	157	340	152
15x6.00 - 6	4,5	155	366	152
16x4.50 - 9	3	105	405	229
16x5.50 - 8	4,25	142	414	203
16x6.50 - 8	5,375	165	405	203
16x7.50 - 8	5,375	188	411	203
17x8.00 - 8	7	203	438	203
17x8.00 - 12	7	203	432	305
18x6.50 - 8	5	163	457	203
18x7.00 - 8	5,5	178	450	203
18x7.50-8	6	191	457	203
18x8.50 - 8	7	214	450	203
18x9.50 - 8	7	235	462	203
19x9.50-8	7,5	240	483	203
19x7.50 - 8	5,5	180	480	203
19x8.00 - 10	7	203	483	254
19x10.00 - 8	8,5	254	483	203
20x8.00-8	6,5	204	508	203
20x8.00 - 10	7	203	500	254
20x9.00-8	7	227	508	203
20x10.00 - 8	8	254	508	203
20x10.00 - 10	8,5	254	508	254
20.5x8.00 - 10	6	208	526	254
21x7.00-10	5,5	177	533	254
21x8.00 - 10	7	203	525	254
AT21x7 - 10	5,5	177	533	254
21x11.00 - 8	8,5	282	518	203
21x11.00 - 10	9	279	525	254
22x8.00 - 10	6	196	556	254
22x8.50 - 12	7	216	551	305
AT22x9 - 8	7	227	559	203
22x10.00 - 8	7	244	572	203
22x10.00 - 10	8,5	254	559	254

Table 7 (2 of 4)
Agricultural high flotation tyres

<i>Tyre size designation</i>	<i>Theoretical rim width code (A1)</i>	<i>Nominal section width (S1) (mm)</i>	<i>Overall diameter (D) (mm)</i>	<i>Nominal rim diameter (d) (mm)</i>
22x11.00 - 8	8,5	284	546	203
22x11.00 - 10	8,5	254	559	254
AT23x7 - 10	5,5	175	587	254
AT23x8 - 11	6,5	204	584	279
23x8.50 - 12	7	214	575	305
23x9.00 - 12	7,5	229	575	305
23x9.50-12	7	235	577	305
23x10.50 - 12	8,5	264	579	305
AT24x8 - 11	6,5	204	610	279
AT24x9 - 11	7	227	610	279
AT24x10 - 11	8	254	610	279
24x8.50 - 12	7	213	602	305
24x8.50 - 14	7	213	602	356
24x11.00 - 10	8,5	254	607	254
24x12.00-12	9,5	304	610	305
24x13.00 - 12	10,5	325	592	305
25x7.50 - 15	5,5	191	640	381
AT25x8 - 12	6,5	204	635	305
25x8.00-12	6,5	203	635	305
25x8.50 - 14	7	213	645	356
25x10.00-12	8	254	635	305
25x10.50 - 15	8	267	640	381
25x11.00-12	9	279	635	305
AT25x11 - 9	9	281	635	229
AT25x11 - 10	8,5	262	645	254

Table 7 (3 of 4)
Agricultural high flotation tyres

T Tyre size a designations b	<i>Theoretical rim width code (A1)</i>	<i>Nominal section width (S1) (mm)</i>	<i>Overall diameter (D) (mm)</i>	<i>Nominal rim diameter (d) (mm)</i>
15x12.00 - 9	10	305	635	229
25x12.50 - 15	10	310	640	381
26x10.00 - 12	10	310	660	305
26x12.00 - 12	10	310	660	305
26x14.00 - 12	12	356	660	305
27x8.50 - 15	7	214	680	381
27x9.50 - 15	7	229	686	381
27x10.50 - 15	8,5	259	691	381
27x10 - 15.3	9	261	685	389
28x9.00 - 15	7	234	710	381
28x13 - 15	11,5	330	711	381
29x12.00 - 15	10	310	742	381
29x12.50 - 15	10	310	742	381
29x13.50 - 15	10	351	742	381
31x11.50 - 15	8	301	793	381
31x12.50 - 15	10	310	792	381
31x13.50 - 15	10	351	782	381
31x13.5 - 15	10	351	782	381
31x15.50 - 15	13	391	792	381
31x15.5 - 15	13	391	792	381
33x12.50 - 15	10	310	843	381
33x15.50 - 15	13	391	843	381
36x13.50 - 15	10	351	909	381
38x14.00 - 20	11	356	991	508
38x18.00 - 20	14	457	991	508
38x20.00 - 16.1	16	488	991	409
41x14.00 - 20	11	356	1 067	508
42x25.00 - 20	20,5	622	1 080	508
43x13.50 - 22	10	360	1 102	559
44x18.00 - 20	14	457	1 143	508
44x41.00 - 20	36	991	1 143	508
48x20.00 - 24	15	457	1 245	610
48x25.00 - 20	20,5	635	1 245	508
48x31.00 - 20	26	775	1 245	508
54x31.00 - 26	26	775	1 397	660

<i>Tyre size designation</i>	<i>Theoretical rim width code (A1)</i>	<i>Nominal section width (S1) (mm)</i>	<i>Overall diameter (D) (mm)</i>	<i>Nominal rim diameter (d) (mm)</i>
66x43.00 - 25	36	1 054	1 702	635
66x43.00 - 26	36	1 054	1 702	660
66x44.00 - 25	36	1 118	1 702	635
67x34.00 - 25	30	864	1 727	635
67x34.00 - 26	30	864	1 727	660
67x34.00 - 30	30	864	1 727	762
68x50.00 - 32	44	1 270	1 753	813
VA73x44.00 - 32	36	1 118	1 880	813
DH73x44.00 - 32	36	1 118	1 880	813
DH73x50.00-32	44	1270	1880	813

Notes:

1. These Tyres may be classified in categories of use "Tractor Drive Wheels" or "Implement".
2. Implement Tyres are identified either by suffix "IMP" placed after the Tyre size designation (e.g. 11x4.00 - 4 IMP) or by the word "IMPLEMENT" marked on the Tyre sidewalls.
3. Tyres of radial structure are identified by means of the letter "R" in place of " - " (e.g. 11x4.00 R 4).
4. Coefficient "b" for the calculation of the Overall diameter Dmax:
 - (a) 1.12 for tyres with Nominal rim Diameter (d) less than 380 mm;
 - (b) 1.10 for tyres with Nominal rim Diameter (d) 381 mm and above.

Annex 6

Test method for measuring tyre dimensions

1. The tyre shall be mounted on the measuring rim specified by the manufacturer and is inflated to a pressure specified by the manufacturer.
- 1.1. To seat the beads do not exceed the inflation pressure marked on the tyre sidewalls.
- 1.2. Having properly seated tyre beads on the rim, adjust the pressure to the value specified for tyre measurements.
2. The tyre fitted on its rim is conditioned to the ambient temperature of the laboratory for at least 24 hours.
3. The pressure is readjusted to the value specified in paragraph 1.
4. The overall width is measured by calliper at six equally-paced points, account being taken of the thickness of the protective ribs or bands. The highest measurement so obtained is taken as the overall width.
5. The outer diameter is determined by measuring the maximum circumference and dividing the figure so obtained by π (3,1416).

Annex 7

Variation of load capacity with speed

(See paragraphs 2.30. and 2.31. of this Regulation)

Part A: Drive wheel tyres for agricultural tractors

Applicable to tyres classified with categories of use: "Tractor drive wheel"
(see paragraph 2.20. of this Regulation)

Variation of load carrying capacity (per cent)

Speed (km/h)	Speed category symbol				(1)
	A2	A6 (+)	A8 (+)	D (+)	
10	[0]	+40	+50	+50	+ 58
15	-6	+30	+34	+34	+ 32
20	-11	+20	+23	+23	+ 26
25	-16	+7	+11	+18,5	+ 19
30	-20	[0]	+7	+15	+ 12
35	-24	-10	+3	+12	+ 10
40	-27	-20	[0]	+9,5	+ 6
45	-	-	-4	+7	+ 2
50	-	-	-9	+5	[0]
55	-	-	-	+3	-
60	-	-	-	+1,5	-
65	-	-	-	[0]	-
70	-	-	-	-9	-

The above load/speed variations table does not apply to IF and VF Tyres.

The above load/speed variations apply when the tyre is not subjected to sustained high torque service.

(+) For field applications with sustained high torque service the values shown in the line 30 km/h apply.

(1) These percentages apply only in case of tyres listed in Annex 5, Table 7, with nominal rim diameter (d) 381 mm and above, marked with speed symbol "B"

Part B: Steering wheel tyres for agricultural and forestry tractors

Applicable to tyres classified with category of use "Tractor steering wheels" and marked "Front" or "F-1" or "F-2" (see paragraph 2.21. of this Regulation)

Variation of load carrying capacity (per cent) (See paragraphs 2.30. and 2.31. of this Regulation)

Speed (km/h)	Speed category symbol	
	A6	A8
10	+50	+67
15	+43	+50
20	+35	+39
25	+15	+28
30	[0]	+11
35	-10	+4
40	-20	[0]
45	-	-7

Part C: Implement tyres

Applicable to tyres classified with categories of use: "Implement" and marked "IMP" or "IMPLEMENT" (see paragraph 2.22. of this Regulation)

Variation of load carrying capacity (per cent) (see paragraphs 2.30. and 2.31. of this Regulation)

Speed (km/h)	Speed category symbol				(1)
	A4	A6(*)	A8(*)	D	
10	+ 20	+ 29	+ 40	+ 80	+ 58
15	+ 12	+ 21	+ 33	+ 73	+ 32
20	[0]	+ 14	+ 26	+ 65	+ 26
25	- 2	+ 7	+ 19	+ 58	+ 19
30	- 5	[0]	+ 12	+ 51	+ 12
35		- 5	+ 5	+ 44	+ 10
40		- 10	[0]	+ 36	+ 6
45			- 5	+ 29	+ 2
50			- 10	+ 21	[0]
55				+ 14	-
60				+ 7	-
65				[0]	-
70				- 9	-

The above load/speed variations apply when the tyre is not subjected to sustained high torque service.

- (*) For tyres with nominal rim diameter code 24 and above, excluding codes 24.5, 26.5 and 30.5, Annex 7, Part A applies.
- (1) These percentages apply only in case of tyres listed in Annex 5, Table 7, with nominal rim diameter (d) 381 mm and above, marked with speed symbol "B".

Part D: Tyres for forestry machines

Applicable to tyres classified with categories of use: "Forestry machines"
(see paragraph 2.41. of this Regulation)

Variation of load carrying capacity (per cent) for tyres marked with speed category
symbol A8

<i>Service condition</i>	<i>Speed (km/h)</i>	<i>per cent</i>
Road service	20	23
	30	7
	40	[0]

Annex 8

Test procedure to assess tyre resistance to bursting

1. Preparing the tyre
 - 1.1. Mount a new tyre on the test equipment. Wheels used for the test shall be suitable to withstand, with no deformation, the highest value of pressure achievable during the test.
 - 1.2. Carefully centre the tyre beads on the retention device and adjust the outer distance of the tyre beads to a value corresponding to the width of the rim specified by the manufacturer pursuant to paragraph 4.1.10. of this Regulation.
 - 1.3. Fill the tyre with water taking care that all the air inside the tyre is expelled.
2. Test procedure
 - 2.1. Activate the apparatus and increase the pressure of the water inside the tyre in order to reach progressively the limit given by two and half times the pressure specified by the tyre manufacturer pursuant to paragraph 4.1.12. of this Regulation;
 - 2.1.1. In no case, however, the limit value shall be lower than 6 bar (600 kPa) or higher than 10 bar (1 000 kPa).
 - 2.2. Maintain constant the value of the pressure for at least 10 minutes.
 - 2.3. Decrease, progressively, the pressure of the water to zero and drain the tyre.
 - 2.4. Whilst the pressure of the water inside the tyre is higher than the ambient pressure, nobody shall stand inside the test room that shall be safely locked.
3. Equivalent test methods

If a method other than that described above is used, its equivalence must be demonstrated.

Annex 9

Load/speed test procedure

1. Scope and range of application
 - 1.1. This test procedure is applicable for new tyres marked with speed category symbol "D".
 - 1.2. It serves the purpose to assess the suitability of the tyre for the claimed performances.
2. Preparing the tyre
 - 2.1. Mount new tyres on the test rim specified by the manufacturer pursuant to paragraph 4.1.10. of this Regulation.
 - 2.1.1. To seat the beads do not exceed the maximum pressure marked on the tyre sidewalls.
 - 2.2. Use a new inner tube when testing tyres with inner tubes (i.e. tyres not bearing the marking "Tubeless").
 - 2.3. With the tyre beads properly seated on the rim, inflate the tyre to the pressure corresponding to the test pressure specified by the tyre manufacturer for the type of test programme, pursuant to paragraph 4.1.15. of this Regulation.
 - 2.4. Condition the tyre and wheel assembly at test room temperature for not less than three hours.
 - 2.5. Readjust the tyre pressure to that specified in paragraph 2.3. above.
 - 2.6. On request of the tyre manufacturer proceed with the test programme as specified in either of the following paragraphs:
Test procedure in a laboratory on a test drum (paragraph 3. below), or
Test procedure on a road using a trailer (paragraph 4.).
3. Test procedure on a test drum
 - 3.1. Mount the tyre and wheel assembly on the test axle and press it against the outer face of a smooth power-driven test drum of at least 1,700 mm \pm 1 per cent in diameter having a surface at least as wide as the tyre tread.
 - 3.1.1. Drum widths narrower than the tyre tread pattern may be used if the tyre manufacturer agrees.
 - 3.2. Test drum speed: 20 km/h.
 - 3.3. Apply to test axle a series of masses in accordance with the load/speed test programme shown in paragraph 3.4. below, with reference to the test load which equates:
 - 3.3.1. The mass corresponding to load index marked on the tyre in case of tyres marked with speed symbol D.

3.4. Load/speed test programme:

<i>Tyre speed category symbol</i>	<i>Test step</i>	<i>Percentage of the test load</i>	<i>Duration (hours)</i>
D	1	66 per cent	7
	2	84 per cent	16
	3	101 per cent	24

3.4.1. In case of a test drum diameter larger than 1,700 mm ± 1 per cent, the above "percentage of test load" shall be increased as follows:

$$F_1 = K \cdot F_2$$

Where:

$$K = \sqrt{\frac{(R_1/R_2) \cdot (R_2 + r_T)}{(R_1 + r_T)}}$$

R_1 is the diameter of test drum, in millimeter

R_2 is the diameter of the reference test drum of 1,700 mm

r_T is the tyre outer diameter (see paragraph 6.2. of this Regulation), in millimeter

F_1 is the percentage of load to be applied for the test drum

F_2 is the percentage of load, as per above table, to be applied for reference test drum of 1,700 mm

Example:

$K = 1$ for a test drum diameter of 1,700 mm;

In case of a test drum diameter of 3,000 mm and a tyre diameter of 1500 mm:

$$K = \sqrt{\frac{(3000/1700) \cdot (1700 + 1500)}{(3000 + 1500)}} = 1.12$$

3.5. The tyre pressure must not be corrected throughout the test and the test load must be kept constant throughout each of the three test steps.

3.6. During the test the temperature in the test room must be maintained at between 20 °C and 30 °C or at another temperature if the manufacturer so agrees.

3.7. The load/speed test programme must be carried out without interruption.

4. Test procedure on a trailer

4.1. Mount two new tyres of the same type on a trailer

4.2. Apply on the trailer a mass in order that each tyre be equally loaded with a test load corresponding to the load carrying capacity allowed for that tyre type at 15 km/h (see load variations in Annex 7).

4.3. Run the trailer at a constant speed of 15 km/h ± 1 km/h for 48 hours.

- 4.3.1. Temporary interruptions are allowed, but they must be compensated by an additional run-in of 5 min for every 20 minutes of interruption.
- 4.4. The tyre pressure must not be corrected and the test load must be kept constant throughout the test.
- 4.5. During the test the ambient temperature shall be between 5 °C and 30 °C or at another temperature if the manufacturer so agrees.
- 5. Equivalent test methods
If a method other than those described above is used, its equivalence must be demonstrated.

Annex 10

Tyre classification code

(Optional marking)

<i>Classification code</i>	<i>Nomenclature</i>
F-1	Agricultural tractor steering wheel tyres: single rib tread
F-2	Agricultural tractor steering wheel tyres: multiple rib tread
F-3	Steering wheel tyres: industrial service (construction application)
G-1	Garden tractor tyres (implement tyres): traction service
G-2	Garden tractor tyres (implement tyres): flotation traction service
G-3	Garden tractor tyres (implement tyres): maximum flotation service
I-1	Agricultural implement tyres: multi-rib tread
I-2	Agricultural implement tyres: moderate traction service
I-3	Agricultural implement tyres: traction tread
I-4	Agricultural implement tyres: plough tail wheel service
I-5	Agricultural implement tyres: steering service
I-6	Agricultural implement tyres: Smooth tread
LS-1	Logging and forestry service tyres: regular tread
LS-2	Logging and forestry service tyres: intermediate tread
LS-3	Logging and forestry service tyres: deep tread
LS-4	Logging and forestry service tyres: shallow tread
R-1	Agricultural tractor drive wheel tyres: regular tread
R-2	Agricultural tractor drive wheel tyres: cane and rice service (deep tread)
R-3	Agricultural tractor drive wheel tyres: flotation service (shallow tread)
R-4	Drive wheel tyres: industrial service (construction application)

Annex 11

Example of the pictogram to be marked on both tyre sidewalls of the tyres to explicit the maximum inflation pressure not to be exceeded for bead seating during tyre mounting

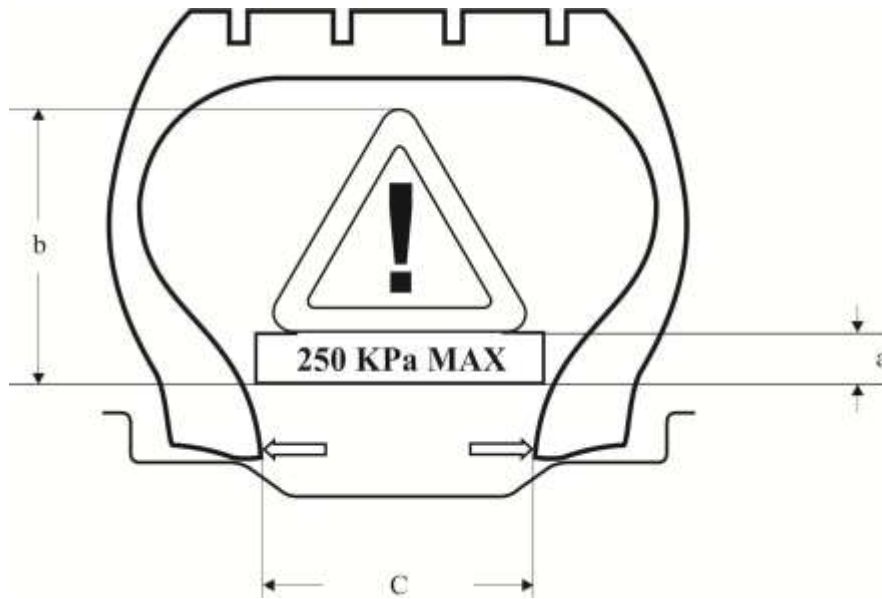

- a = 2 mm min (height of lettering)
- b = 12 mm min for tyre section height \leq 120 mm
18 mm min for tyre section height $>$ 120 mm
- c = 14 mm min (width of lettering)

The pictogram must be placed on both sidewalls.

The value of inflation pressure (250 kPa in the example) must be the same as specified by the tyre manufacturer in paragraph 4.1.14. of this Regulation.