

26 June 2014

---

## Agreement

### **Concerning the Adoption of Uniform Technical Prescriptions for Wheeled Vehicles, Equipment and Parts which can be Fitted and/or be Used on Wheeled Vehicles and the Conditions for Reciprocal Recognition of Approvals Granted on the Basis of these Prescriptions\***

(Revision 2, including the amendments which entered into force on 16 October 1995)

---

## **Addendum 30: Regulation No. 31**

### **Revision 3**

Incorporating all valid text up to:

Erratum to Revision 2 of the Regulation (*Erratum by the secretariat*)

Supplement 8 to the 02 series of amendments – Date of entry into force: 15 July 2013

03 series of amendments - Date of entry into force: 10 June 2014

### **Uniform provisions concerning the approval of power-driven vehicle's halogen sealed-beam headlamps (HSB) emitting a European asymmetrical passing beam or a driving beam or both**



**UNITED NATIONS**

---

\* Former title of the Agreement: Agreement Concerning the Adoption of Uniform Conditions of Approval and Reciprocal Recognition of Approval for Motor Vehicle Equipment and Parts, done at Geneva on 20 March 1958.



## Regulation No. 31

### Uniform provisions concerning the approval of power-driven vehicle's halogen sealed-beam headlamps (HSB) emitting a European asymmetrical passing beam or a driving beam or both

#### Contents

Page

#### Regulation

1. Scope .....	5
2. Definitions.....	5
3. Application for approval .....	6
4. Markings .....	7
5. Approval.....	7
6. General specifications .....	10
7. Rated and test values .....	11
8. Illumination .....	11
9. Colour.....	13
10. Gauging of discomfort .....	13
11. Conformity of production.....	14
12. Penalties for non-conformity of production .....	15
13. Modification and extension of approval of a type of halogen sealed-beam headlamp unit (HSB unit) .....	15
14. Production definitively discontinued.....	15
15. Transitional provisions .....	16
16. Names and addresses of Technical Services responsible for conducting approval tests and of Type Approval Authorities.....	16

#### Annexes

1 Communication .....	17
2 Arrangements of the approval marks .....	19
3 Electronical connections of HSB units.....	26
4 Measuring screen .....	29
5 Minimum requirements for conformity of production control procedures.....	31
6 Tests for stability of photometric performance of headlamps in operation .....	34
7 Requirements for lamps incorporating lenses of plastic material - testing of lens or material samples and of complete lamps.....	38

Appendix 1 - Chronological order of approval tests .....	43
Appendix 2 - Method of measurement of the diffusion and transmission of light .....	44
Appendix 3 - Spray testing method .....	46
Appendix 4 - Adhesive tape adherence test .....	47
8 Minimum requirements for sampling by an inspector.....	48

## 1. Scope<sup>1</sup>

This Regulation applies to headlamps for vehicles of categories M, N, and T.<sup>2</sup>

## 2. Definitions

For the purpose of this Regulation:

- 2.1. "*Halogen sealed-beam headlamp unit*" (hereinafter termed "HSB unit") means a headlamp whose components, including a reflector of glass, metal or other material, an optical system and one or more halogen light sources, form an integral whole which is indivisibly joined and cannot be dismantled without rendering the unit completely unusable. Such units are:
  - 2.1.1. Of "category 1", when they emit only a driving beam;
  - 2.1.2. Of "category 21", when they emit only a passing beam;
  - 2.1.3. Of "category 22", when they emit, at the user's choice, either a driving beam or a passing beam;
- 2.2. "*Lens*" means the outermost component of the headlamp (unit) which transmits light through the illuminating surface;
- 2.3. "*Coating*" means any product or products applied in one or more layers to the outer face of a lens;
- 2.4. "*HSB units of different types*" means units which differ in such essential respects as:
  - 2.4.1. The trade name or mark;
  - 2.4.2. The characteristics of the optical system;
  - 2.4.3. the inclusion or elimination of components capable of altering the optical effects by reflection, refraction, absorption and/or deformation during operation; the fitting or elimination of filters intended solely to change the colour of the beam but not its light distribution does not constitute a change of type;
  - 2.4.4. The rated voltage;
  - 2.4.5. The shape of the filament or filaments;
  - 2.4.6. The kind of beam produced (passing beam, driving beam or both);
  - 2.4.7. The materials constituting the lens and coating, if any.
- 2.5. "*Colour of the light emitted from the device*" The definitions of the colour of the light emitted given in Regulation No. 48 and its series of amendments in

---

<sup>1</sup> Nothing in this Regulation shall prevent a Party to the Agreement applying this Regulation from prohibiting the combination of an HSB unit incorporating a lens of plastic material approved under this Regulation with a mechanical headlamp-cleaning device (with wipers).

<sup>2</sup> As defined in the Consolidated Resolution on the Construction of Vehicles (R.E.3.), document ECE/TRANS/WP.29/78/Rev.3, para. 2 - [www.unece.org/trans/main/wp29/wp29wgs/wp29gen/wp29resolutions.html](http://www.unece.org/trans/main/wp29/wp29wgs/wp29gen/wp29resolutions.html)

force at the time of application for type approval shall apply to this Regulation.

### **3. Application for approval**

- 3.1. The application for approval shall be submitted by the owner of the trade name or mark or by his duly accredited representative. It shall specify:
  - 3.1.1. Whether the HSB unit is intended to provide both a passing beam and a driving beam or only one of these beams;
  - 3.1.2. Where the HSB unit is intended to provide a passing beam, whether it is designed for both right-hand and left-hand traffic or for right-hand or left-hand traffic only.
- 3.2. Every application for approval shall be accompanied by:
  - 3.2.1. drawings in triplicate, sufficiently detailed to permit identification of the type and giving a front view of the HSB unit (with, if applicable, details of the lens moulding) and a cross-section; also the filament(s) and shield(s) shall be shown on the drawings at a scale of 2:1 both in front view and in side view; the drawing shall show the position intended for the approval number and the additional symbols in relation to the circle of the approval mark;
  - 3.2.2. A brief technical description;
  - 3.2.3. Samples as follows:
    - 3.2.3.1. For approval of an HSB unit emitting uncoloured light: five samples;
    - 3.2.3.2. For approval of an HSB unit emitting coloured light: two coloured-light samples and five uncoloured-light samples of the same type, differing from the type submitted, only in that the lens or filter is not coloured;
    - 3.2.3.3. In the case of HSB units which emit coloured light, which differ from uncoloured-light units only in the colour of light emitted and which have already satisfied the requirements of paragraphs 6., 7. and 8. below, it will be sufficient to submit only one sample of a coloured-light unit to undergo the tests described in paragraph 9. below.
  - 3.2.4. For the test of plastic material of which the lenses are made:
    - 3.2.4.1. Thirteen lenses.
      - 3.2.4.1.1. Six of these lenses may be replaced by six samples of material at least 60 x 80 mm in size, having a flat or convex outer surface and a substantially flat area (radius of curvature not less than 300 mm) in the middle measuring at least 15 x 15 mm.
      - 3.2.4.1.2. Every such lens or sample of material shall be produced by the method to be used in mass production,
    - 3.2.4.2. A reflector to which the lenses can be fitted in accordance with the manufacturer's instructions.
- 3.3. The characteristics of the materials making up the lenses and coatings, if any, should be accompanied by the test report on these materials and coatings if they have already been tested.

- 3.4. The Type Approval Authority shall verify the existence of satisfactory arrangements for ensuring effective control of the conformity of production before type approval is granted.

## **4. Markings<sup>3</sup>**

- 4.1. HSB units submitted for approval shall bear the trade name or mark of the applicant.
- 4.2. They shall comprise, on the lens, a space of sufficient size to accommodate the approval mark and the additional symbols provided for in paragraph 5. below; the space shall be shown in the drawings referred to in paragraph 3.2.1. above.
- 4.3. They shall bear, either on the lens or on the body, the rated voltage and rated wattage of the driving-beam filament, followed by the rated wattage of the passing-beam filament, where applicable.

## **5. Approval**

- 5.1. General
- 5.1.1. If all the HSB unit type samples submitted in pursuance of paragraph 3. above meet the requirements of this Regulation, approval shall be granted.
- 5.1.2. Where grouped, combined or reciprocally incorporated lamps satisfy the requirements of more than one Regulation, a single international approval mark may be affixed provided that each of the grouped, combined or reciprocally incorporated lamps satisfies the provisions applicable to it.
- 5.1.3. An approval number shall be assigned to each type approved. Its first two digits (at present 03) shall indicate the series of amendments incorporating the most recent major technical amendments made to the Regulation at the time of issue of the approval. The same Contracting Party may not assign the same number to another type of HSB unit covered by this Regulation except in the case of an extension of the approval to a device differing only in the colour of the light emitted.
- 5.1.4. Notice of approval or of extension or refusal or withdrawal of approval or production definitively discontinued of a type of optical unit pursuant to this Regulation shall be communicated to the Parties to the 1958 Agreement applying this Regulation, by means of a form conforming to the model in Annex 1 to this Regulation.
- 5.1.5. In addition to the mark prescribed in paragraph 4.1. above, an approval mark as described in paragraphs 5.2. and 5.3. below shall be affixed in the spaces referred to in paragraph 4.2. above to every headlamp conforming to a type of HSB unit approved under this Regulation.

---

<sup>3</sup> In the case of units designed to meet the requirements of traffic moving on one side of the road only (either right or left), it is further recommended that the area which can be occulted to prevent discomfort to users in a country where traffic moves on the side of the road opposite to that for which the unit was designed should be outlined indelibly on the lens. This marking is not necessary, however, where the area is clearly apparent from the design.

- 5.2. Composition of the approval mark
- The approval mark shall consist of:
- 5.2.1. An international approval marking, comprising
- 5.2.1.1. A circle surrounding the letter "E" followed by the distinguishing number of the country which has granted approval;<sup>4</sup>
- 5.2.1.2. The approval number prescribed in paragraph 5.1.3. above;
- 5.2.2. The following additional symbol (or symbols):
- 5.2.2.1. On HSB optical units meeting left-hand traffic requirements only, a horizontal arrow, pointing to the right of an observer, facing the HSB optical unit, i.e., to the side of the road on which the traffic moves;
- 5.2.2.2. On HSB optical units meeting the requirements of this Regulation in respect of the passing beam only, the letters "HSC";
- 5.2.2.3. On HSB optical units meeting the requirements of this Regulation in respect of the driving beam only, the letters "HSR";
- 5.2.2.4. On HSB optical units meeting the requirements of this Regulation in respect of both the passing beam and the driving beam, the letters "HSCR";
- 5.2.2.5. On HSB optical units meeting the requirements of this Regulation in respect of the driving beam, an indication of the maximum luminous intensity expressed by a reference mark, as defined in paragraph 8.3.2.1.2. below, placed near the circle surrounding the letter "E";
- 5.2.2.6. On HSB units incorporating a lens of plastic material, the group of letters "PL" near the symbols prescribed in paragraphs 5.2.2.3. to 5.2.2.5. above;
- 5.2.2.7. The two digits of the approval number (at present 03) which indicate the series of amendments incorporating the most recent major technical amendments made to the Regulation at the time of issue of the approval and, if necessary, the required arrow may be marked close to the above additional symbols.
- 5.2.2.8. In every case the relevant operating mode used during the test procedure according to paragraph 1.1.1.1. of Annex 6 to this Regulation and the allowed voltage(s) according to paragraph 1.1.1.2. of Annex 6 to this Regulation shall be stipulated on the approval forms and on the communication forms transmitted to the countries which are Contracting Parties to the Agreement and which apply this Regulation.
- In the corresponding cases the device shall be marked as follows:
- On units meeting the requirements of this Regulation which are so designed that the filament of the passing beam shall not be lit simultaneously with that of any other lighting function with which it may be reciprocally incorporated:
- An oblique stroke (/) shall be placed behind the passing lamp symbol in the approval mark.

---

<sup>4</sup> The distinguishing numbers of the Contracting Parties to the 1958 Agreement are reproduced in Annex 3 to the Consolidated Resolution on the Construction of Vehicles (R.E.3), document ECE/TRANS/WP.29/78/Rev. 3, Annex 3 - [www.unece.org/trans/main/wp29/wp29wgs/wp29gen/wp29resolutions.html](http://www.unece.org/trans/main/wp29/wp29wgs/wp29gen/wp29resolutions.html)



- 5.2.2.9. The marks and symbols referred to in paragraphs 5.2.1. and 5.2.2. above shall be clearly legible and be indelible even when the optical unit is fitted in the vehicle.
- 5.3. Arrangement of the approval mark
- 5.3.1. Independent lamps
- Annex 2, Figures 1 to 7, to this Regulation gives examples of arrangements of the approval mark with the above-mentioned additional symbols.
- 5.3.2. Grouped, combined or reciprocally incorporated lamps
- 5.3.2.1. Where grouped, combined or reciprocally incorporated lamps have been found to comply with the requirements of several Regulations, a single international approval mark may be affixed, consisting of a circle surrounding the letter "E" followed by the distinguishing number of the country which has granted the approval, and an approval number. This approval mark may be located anywhere on the grouped, combined or reciprocally incorporated lamps, provided that:
- 5.3.2.1.1. It is visible after their installation;
- 5.3.2.1.2. No part of the grouped, combined or reciprocally incorporated lamps that transmits light can be removed without at the same time removing the approval mark.
- 5.3.2.2. The identification symbol for each lamp appropriate to each Regulation under which approval has been granted, together with the corresponding series of amendments incorporating the most recent major technical amendments to the Regulation at the time of issue of the approval and, if necessary, the required arrow shall be marked:
- 5.3.2.2.1. Either on the appropriate light-emitting surface,
- 5.3.2.2.2. Or in a group, in such a way that each of the grouped, combined or reciprocally incorporated lamps may be clearly identified (see four possible examples in Annex 2 to this Regulation).
- 5.3.2.3. The size of the components of a single approval mark shall not be less than the minimum size required for the smallest of the individual marks by the Regulation under which approval has been granted.
- 5.3.2.4. An approval number shall be assigned to each type approved. The same Contracting Party may not assign the same number to another type of grouped, combined or reciprocally incorporated lamps covered by this Regulation.
- 5.3.2.5. Annex 2, Figure 8, to this Regulation gives examples of arrangements of approval marks for grouped, combined or reciprocally incorporated lamps with all the above-mentioned additional symbols.
- 5.3.3. Lamps, the lens of which is used for different types of lamps and which may be reciprocally incorporated or grouped with other lamps
- The provisions laid down in paragraph 5.3.2. above are applicable.
- 5.3.3.1. In addition, where the same lens is used, the latter may bear the different approval marks relating to the different types of headlamps or units of lamps, provided that the main body of the HSB unit, even if it cannot be separated

from the lens, also comprises the space described in paragraph 4.2. above and bears the approval mark of the actual functions.

If different types of HSB units comprise the same main body, the latter may bear the different approval marks.

- 5.3.3.2. Annex 2, Figure 9, to this Regulation gives examples of arrangements of approval marks relating to the above case.

## **6. General specifications**

- 6.1. Every sample shall conform to the specifications set forth in this paragraph and in paragraphs 7. and 8. below and, if necessary, to those set forth in paragraph 9 below.

- 6.2. HSB units shall be so designed and made that in normal use, despite the vibrations to which they may then be subjected, their satisfactory operation continues to be ensured and they retain the characteristics prescribed by this Regulation.

- 6.2.1. HSB optical units shall be fitted with a device enabling them to be so adjusted on the vehicle as to comply with the rules applicable to them. Such a device need not be fitted on HSB optical unit insert if the use of such inserts is confined to vehicles on which the headlamp setting can be adjusted by other means.

Where an HSB optical unit providing a driving beam and an HSB optical unit providing a passing beam are assembled as exchangeable subunits to form a composite unit, the adjusting device shall enable each HSB unit individually to be duly adjusted.

- 6.2.2. However, this will not apply to headlamp assemblies whose reflectors are indivisible. For this type of assembly the requirements of paragraph 8.3. of this Regulation shall apply. In the case where more than one light source is used to provide the main beam, the combined main-beam functions will be used to determine the maximum value of the illumination ( $E_M$ ).

- 6.3. The terminals shall be in electrical contact with the appropriate filament or filaments only and shall be robust and firmly fixed to the HSB unit.

- 6.4. HSB units shall comprise electrical connections in conformity with those shown in one of the patterns reproduced in Annex 3 to this Regulation and shall be of the dimensions specified in that annex.

- 6.5. Complementary tests shall be done according to the requirements of Annex 6 to this Regulation to ensure that in use there is no excessive change in photometric performance.

- 6.6. If the lens of the HSB unit is of plastic material, tests shall be done according to the requirements of Annex 7 to this Regulation.

## **7. Rated and test values**

- 7.1. The rated voltage is 12 volts.<sup>5</sup>
- 7.2. The wattage shall not exceed 75 watts on the driving beam filament and 68 watts on the passing beam filament measured at a test voltage of 13.2 volts.

## **8. Illumination<sup>6</sup>**

- 8.1. General specifications
  - 8.1.1. HSB units shall be made so as to give adequate illumination without dazzle when emitting the passing beam and good illumination when emitting the driving beam.
  - 8.1.2. The illumination produced by the HSB unit shall be determined by means of a vertical screen set up 25 m forward of the unit as shown in Annex 4 to this Regulation.<sup>7</sup>
  - 8.1.3. On this screen, the illumination referred to in paragraphs 8.2.5., 8.2.6. and 8.3. below shall be measured by means of a photoreceptor, the effective area of which shall be contained within a square of 65 mm side.
- 8.2. Requirements concerning the passing beam
  - 8.2.1. The passing beam shall produce a "cut-off" sharp enough to serve as a satisfactory means of adjustment. The "cut-off" shall be a horizontal straight line on the side opposite to the direction of the traffic for which the unit is intended. On the other side it shall not extend beyond either the broken line HV H1 H4 formed by a straight line HV H1 making a 45° angle with the horizontal and a straight line H1 H4, 25 cm above the straight line hh, or the straight line HV H3, inclined at an angle of 15° above the horizontal (see Annex 4 to this Regulation). A "cut-off" extending beyond both line HV H2 and line H2 H4 and resulting from a combination of the above two possibilities shall in no circumstances be permitted.
  - 8.2.2. The HSB unit shall be so aimed that on the passing beam:
    - 8.2.2.1. In the case of HSB units designed to meet the requirements of right-hand traffic, the "cut-off" on the left half of the screen<sup>8</sup> is horizontal and, in the case of HSB units designed to meet the requirements of left-hand traffic, the "cut-off" on the right half of the screen is horizontal;
    - 8.2.2.2. This horizontal part of the "cut-off" is situated on the screen 25 cm below the level hh (see Annex 4 to this Regulation);

---

<sup>5</sup> Requirements for HSB units with a rated voltage of 24 volts are under consideration.

<sup>6</sup> All photometric measurements shall be made at the rated voltage specified in paragraph 7.1.

<sup>7</sup> If, in the case of an HSB unit designed to meet the requirements of this Regulation in respect of the passing beam only, the focal axis diverges appreciably from the general direction of the beam, lateral adjustment shall be effected in the manner which best satisfies the requirements for illumination at points 75 R and 50 R for right-hand traffic and 75 L and 50 L for left-hand traffic.

<sup>8</sup> The test screen shall be wide enough to allow examination of the "cut-off" over a range of at least 5° on either side of the line vv.

- 8.2.2.3. The "elbow" of the "cut-off" is on line vv.<sup>9</sup>
- 8.2.3. When so adjusted, the HSB unit need meet only the requirements laid down in paragraphs 8.2.5. and 8.2.6. below if approval thereof is sought solely for provision of a passing beam;<sup>10</sup> if it is intended to provide both a passing beam and a driving beam it shall meet the requirements laid down in paragraphs 8.2.5., 8.2.6. and 8.3 below.
- 8.2.4. Where an HSB unit so adjusted does not meet the requirements laid down in paragraphs 8.2.5., 8.2.6. and 8.3. below, its alignment may be changed provided that the axis of the beam is not displaced laterally by more than 1° (= 44 cm) to the right or left.<sup>11</sup> To facilitate alignment by means of the "cut-off", the unit may be partially occulted in order to sharpen the "cut-off".
- 8.2.5. The illumination produced on the screen by the passing beam shall meet the following requirements:

<i>Point on measuring screen</i>		<i>Required illumination in lux</i>
<i>HSB units for right-hand traffic</i>	<i>HSB units for left-hand traffic</i>	
B 50 L	B 50 L	≤ 0.4
75 L	75 L	≥ 12
75 L	75 R	≤ 12
50 L	50 R	≥ 12
50 R	50 L	≤ 15
50 V	20 V	≥ 6
25 L	25 R	≥ 2
25 R	25 L	≥ 2
		≤ 0.7
		≥ 3
Any point in zone III		≤ 2 x (E <sub>50 R</sub> or * E <sub>50 L</sub> )
" " " " IV		
" " " " I		

\* E<sub>50 R</sub> and E<sub>50 L</sub> are the illuminations actually measured.

- 8.2.6. There shall be no lateral variations detrimental to good visibility in any of the Zones I, II, III and IV.

<sup>9</sup> If the beam does not have a "cut-off" with a clear "elbow", lateral adjustment shall be effected in the manner which best satisfies the requirements for illumination at points 75 R and 50 R for right-hand traffic and 75 L and 50 L for left-hand traffic.

<sup>10</sup> An HSB unit designed to emit a passing beam may incorporate a driving beam not subject to this specification.

<sup>11</sup> The limit of realignment of 1° to the right or left is not incompatible with vertical realignment upward or downward. The latter is limited only by the requirements of paragraph 8.3. However, the horizontal part of the "cut-off" should not extend beyond the line hh (the provisions of paragraph 8.3. are not applicable to HSB units intended to meet the requirements of this Regulation only for provision of a passing beam).

- 8.3. Requirements concerning the driving beam
- 8.3.1. In the case of an HSB unit designed to provide a driving beam and a passing beam, measurements of the illumination produced on the screen by the driving beam shall be taken with the same HSB unit alignment as for measurements under paragraphs 8.2.5. and 8.2.6. above; if the HSB unit provides a driving beam only, it shall be so adjusted that the area of maximum illumination is centered on the point of intersection HV of lines hh and vv; such an HSB unit need meet only the requirements laid down in paragraph 8.3.
- 8.3.2. The illumination produced on the screen by the driving beam shall meet the following requirements:
- 8.3.2.1. The point of intersection HV of lines hh and vv shall be situated within the isolux 80 per cent of maximum illumination. This maximum value ( $E_M$ ) shall not be less than 48 lux. The maximum value ( $E_M$ ) shall not exceed 240 lux; in addition, in the case of a combined passing and driving HSB unit, it shall in no case exceed 16 times the illumination measured for the passing beam at point 75 R (or 75 L).
- 8.3.2.1.1. The maximum intensity ( $I_M$ ) of the driving beam expressed in thousands of candelas shall be calculated by the formula:
- $$I_M = 0.625 E_M$$
- 8.3.2.1.2. The reference mark ( $I'_M$ ) of this maximum intensity, referred to in paragraph 5.2.2.5. above, shall be obtained by the ratio:
- $$I'_M = \frac{I_M}{3} = 0.208 E_M$$
- This value shall be rounded off to the nearest value 7.5 - 10 - 12.5 - 17.5 - 20 - 25 - 27.5 - 30 - 37.5 - 40 - 45 - 50.
- 8.3.2.2. Starting from point HV, horizontally to the right and left, the illumination shall be not less than 24 lux up to a distance of 1.125 m and not less than 6 lux up to a distance of 2.25 m.

## 9. Colour

- 9.1. HSB units shall emit white light.

## 10. Gauging of discomfort

The discomfort caused by the passing beam of HSB units shall be gauged.<sup>12</sup>

---

<sup>12</sup> This requirement will be subject to a recommendation to Type Approval Authorities.

## **11. Conformity of production**

- 11.1. Headlamps approved under this Regulation shall be so manufactured as to conform to the type approved by meeting the requirements set forth in paragraphs 8. and 9 above.
- 11.2. In order to verify that the requirements of paragraph 11.1. above are met, suitable controls of the production shall be carried out.
- 11.3. The holder of the approval shall in particular:
  - 11.3.1. Ensure the existence of procedures for the effective control of the quality of products;
  - 11.3.2. Have access to the control equipment necessary for checking the conformity to each approved type;
  - 11.3.3. Ensure that data of test results are recorded and that related documents shall remain available for a period to be determined in accordance with the Type Approval Authority;
  - 11.3.4. Analyze the results of each type of test in order to verify and ensure the stability of the product characteristics, making allowance for variation of an industrial production;
  - 11.3.5. Ensure that for each type of product at least the tests prescribed in Annex 5 to this Regulation are carried out;
  - 11.3.6. Ensure that any collecting of samples giving evidence of non-conformity with the type of test considered shall give rise to another sampling and another test. All the necessary steps shall be taken to re-establish the conformity of the corresponding production.
- 11.4. The Type Approval Authority which has granted type approval may at any time verify the conformity control methods applicable to each production unit.
  - 11.4.1. In every inspection, the test books and production survey records shall be presented to the visiting inspector.
  - 11.4.2. The inspector may take samples at random to be tested in the manufacturer's laboratory. The minimum number of samples may be determined in the light of the results of the manufacturer's own checks.
  - 11.4.3. When the quality level appears unsatisfactory or when it seems necessary to verify the validity of the tests carried out in the application of paragraph 11.4.2. above, the inspector shall select samples, to be sent to the Technical Service which has conducted the type approval tests, using the criteria of Annex 8 to this Regulation.
  - 11.4.4. The Type Approval Authority may carry out any test prescribed in this Regulation. These tests will be on samples selected at random without causing distortion of the manufacturer's delivery commitments and in accordance with the criteria of Annex 8 to this Regulation.
  - 11.4.5. The Type Approval Authority shall strive to obtain a frequency of inspection of once every two years. However, this is at the discretion of the Type Approval Authority and their confidence in the arrangements for ensuring effective control of the conformity of production. In the case where negative results are recorded, the Type Approval Authority shall ensure that all

necessary steps are taken to re-establish the conformity of production as rapidly as possible.

- 11.5. Headlamps with apparent defects are disregarded.
- 11.6. The reference mark is disregarded.

## **12. Penalties for non-conformity of production**

- 12.1. The approval granted in respect of a type of HSB unit pursuant to this Regulation may be withdrawn if the requirements set forth above are not met, or if an HSB unit bearing the approval mark does not conform to the type approved.
- 12.2. If a Contracting Party to the Agreement applying this Regulation withdraws an approval it has previously granted, it shall forthwith so notify the other Contracting Parties applying this Regulation, by means of a communication form conforming to the model in Annex 1 to this Regulation.

## **13. Modification and extension of approval of a type of halogen sealed-beam headlamp unit (HSB unit)**

- 13.1. Every modification of the type of HSB unit shall be notified to the Type Approval Authority which approved the type of HSB unit. The Authority may then either:
  - 13.1.1. Consider that the modifications made are unlikely to have an appreciable adverse effect and that in any case the HSB unit still complies with the requirements; or
  - 13.1.2. Require a further test report from the Technical Service responsible for conducting the tests.
- 13.2. Confirmation or refusal of approval, specifying the alterations shall be communicated by the procedure specified in paragraph 5.1.4. above to the Parties to the Agreement applying this Regulation.
- 13.3. The Type Approval Authority issuing the extension of approval shall assign a series number for such an extension and inform thereof the other Parties to the 1958 Agreement applying this Regulation by means of a communication form conforming to the model in Annex 1 to this Regulation.

## **14. Production definitively discontinued**

If the holder of an approval completely ceases to manufacture a type of HSB unit approved in accordance with this Regulation, he shall so inform the Type Approval Authority which granted the approval. Upon receiving the relevant communication, that Authority shall inform thereof the other Parties to the 1958 Agreement applying this Regulation by means of a communication form conforming to the model in Annex 1 to this Regulation.

## **15. Transitional provisions**

- 15.1. As from twelve months after the official date of entry into force of the 03 series of amendments to this Regulation, Contracting Parties applying this Regulation shall cease to grant approvals according to this Regulation.
- 15.2. Contracting Parties applying this Regulation shall not refuse to grant extensions of approval to this and any previous series of amendments to this Regulation.
- 15.3. Existing approvals granted before the official date of entry into force of the 03 series of amendments to this Regulation and all extensions of approvals, including those to a preceding series of amendments to this Regulation granted subsequently, shall remain valid indefinitely.
- 15.4. Contracting Parties applying this Regulation shall continue to issue approvals for headlamps on the basis of this and any previous series of amendments to this Regulation, provided that the headlamps are intended as replacements for fitting to vehicles in use.
- 15.5. Contracting Parties applying this Regulation shall continue to allow fitting of a headlamp approved to this Regulation on a vehicle or vehicle type.
- 15.6. Contracting Parties applying this Regulation shall continue to allow fitting or use on a vehicle in use of a headlamp approved to this Regulation as amended by any previous series of amendments, provided that the headlamp is intended for replacement.

## **16. Names and addresses of Technical Services responsible for conducting approval tests and of Type Approval Authorities**

The Contracting Parties to the 1958 Agreement applying this Regulation shall communicate to the United Nations Secretary General the names and addresses of the Technical Services responsible for conducting approval tests and of the Type Approval Authorities which grant approval and to which forms certifying approval or extension or refusal or withdrawal of approval, or production definitively discontinued, issued in other countries, are to be sent.



# Annex 1

## Communication

(Maximum format: A4 (210 x 297 mm))



Issued by: .....  
 Name of administration: .....  
 .....  
 .....

Concerning:<sup>2</sup> Approval granted,  
 Approval extended,  
 Approval refused,  
 Approval withdrawn,  
 Production definitively discontinued,

of a type of halogen sealed-beam headlamp unit (HSB unit) pursuant to Regulation No. 31

Approval No. .... Extension No. ....

1. HSB unit submitted for approval as type<sup>3</sup> .....  
 Rated voltage .....  
 Rated wattage .....
2. The passing lamp filament may/may not<sup>2</sup> be lit simultaneously with the driving lamp filament and/or another reciprocally incorporated lamp
3. Trade name or mark .....
4. Manufacturer's name and address .....
5. If applicable, name and address of manufacturer's representative .....  
 .....
6. Submitted for approval on .....

<sup>1</sup> Distinguishing number of the country which has granted/extended/refused/withdrawn approval (see approval provisions in the Regulation).

<sup>2</sup> Strike out what does not apply

<sup>3</sup> Indicate the appropriate marking selected from the list below:

HSCR, HSCR, HSCR, HSC, HSC, HSC, HSR, HSC/R, HSC/R, HSC/R, HSC/, HSC/,  
 HSC/, HSCR PL, HSCR PL, HSCR PL, HSC PL, HSC PL, HSC PL, HSC PL, HSR PL,  
 HSC/R PL, HSC/R PL, HSC PL, HSC PL, HSC PL

7. Technical Service responsible for conducting approval tests .....
8. Date of report issued by that Service .....
9. Number of report issued by that Service .....
10. Approval granted/refused/extended/withdrawn<sup>2</sup>
11. Reason(s) of extension (if applicable) .....
12. Maximum illumination (in lux) of the driving beam at 25 m from  
the HSB unit ..... (average for 5 units)
13. Place.....
14. Date .....
15. Signature .....
16. The attached drawing, No. .... shows the unit.

## Annex 2

### Arrangements of the approval marks

Figure 1

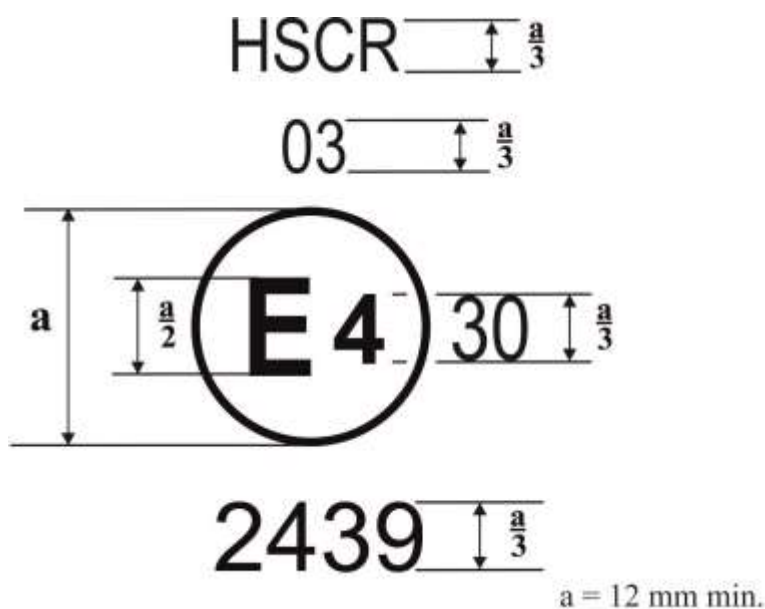

The above approval mark affixed to an HSB optical unit indicates that the unit concerned was approved in the Netherlands (E 4) under number 2439, that it meets the requirements of this Regulation, as amended by the 03 series of amendments, in respect of both the driving beam and the passing beam, and that it is designed for right-hand traffic only.

The Figure 30 indicates that the maximum intensity of the driving beam is between 86,250 and 101,250 candelas.

*Note:* The approval number and the additional symbol(s) shall be placed close to the circle and either above or below the letter "E", or to the right or left of that letter. The digits of the approval number shall be on the same side of the letter "E" and face the same direction. The use of Roman numerals as approval numbers should be avoided so as to prevent any confusion with other symbols.

Figure 2

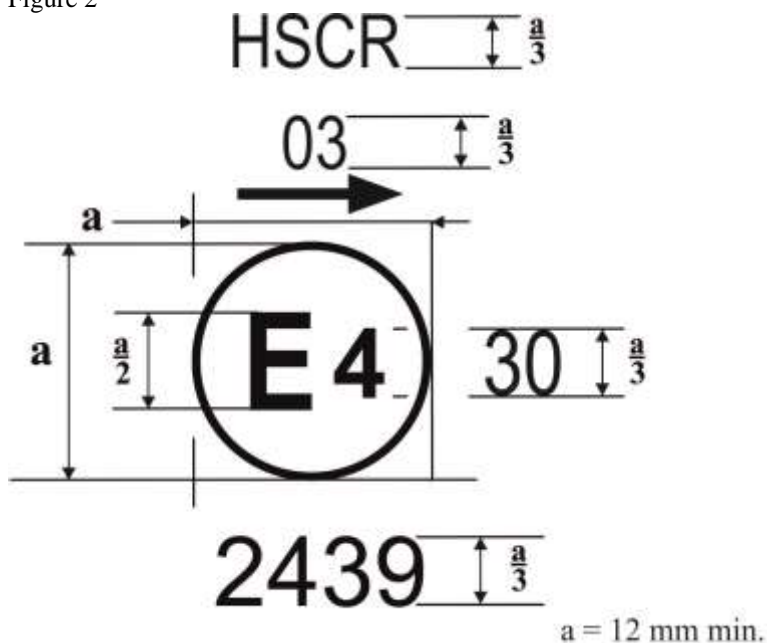

The above approval mark affixed to an HSB optical unit indicates that the unit concerned meets the requirements of this Regulation as amended by the 03 series of amendments, with respect to both the passing beam and the driving beam and that it is designed for left-hand traffic only.

Figure 3a



The above approval mark affixed to an HSB optical unit indicates that the unit concerned meets the requirements of this Regulation as amended by the 03 series of amendments, in respect of the passing beam only, and that it is designed for right-hand traffic only.

Figure 3b



Figure 4



Figure 5



The above approval marks affixed to HSB optical units incorporating the lens of plastic material indicate that the units concerned meet the requirements of this Regulation, as amended by the 03 series of amendments:

With respect to the passing beam only, and that they are designed for left-hand traffic only

With respect to the driving beam only.

The number 30 indicates that the maximum intensity of the driving beam is between 82,500 and 101,250 candelas.



Identification of an HSB unit meeting the requirements of Regulation No. 31

With respect to both the passing beam and the driving beam and designed for right-hand traffic only.

With respect to the passing beam only and designed for right-hand traffic only.

The passing lamp filament shall not be lit simultaneously with the driving lamp filament and/or another reciprocally incorporated lamp.

Figure 8  
**Simplified marking for grouped, combined or reciprocally incorporated lamps**

(The vertical and horizontal lines schematize the shape of the light-signalling device. They are not part of the approval mark.)

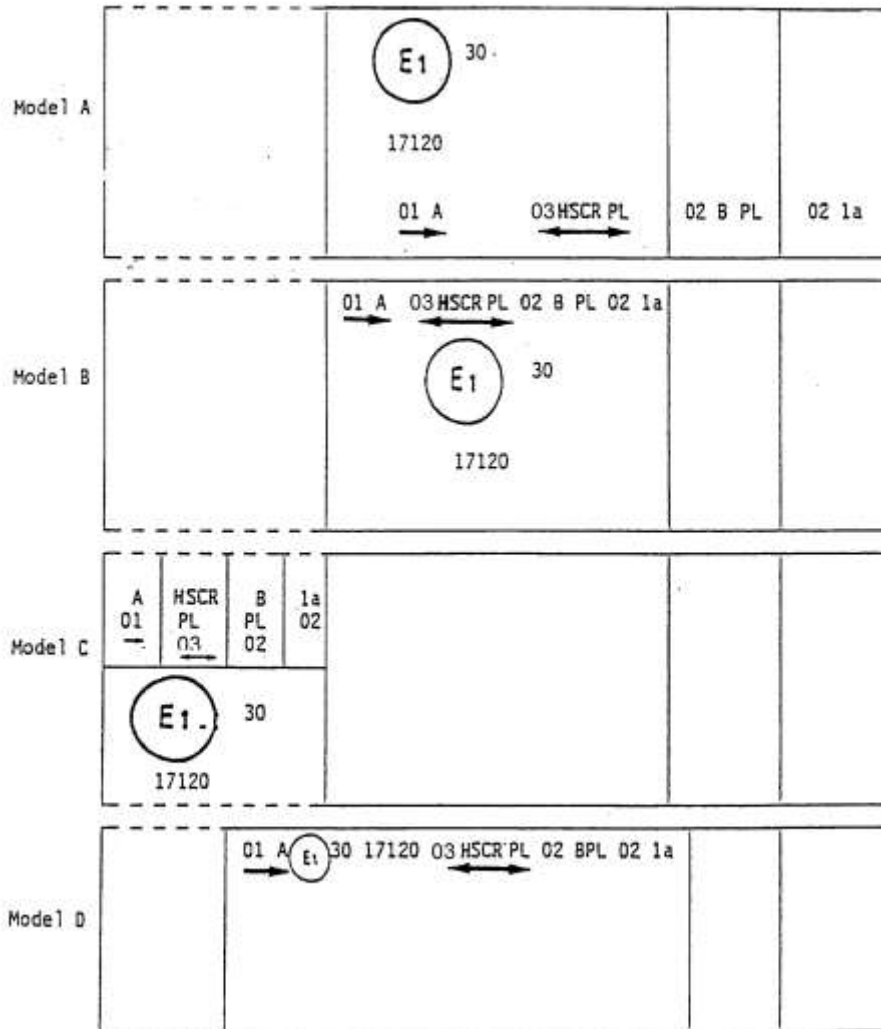

*Note:* The four examples shown above correspond to a lighting device bearing an approval mark relating to:

A front position lamp approved in accordance with the 02 series of amendments to Regulation No. 7;

An HSB optical unit with a passing beam designed for right-hand and left-hand traffic and a driving beam with a maximum intensity comprised between 86,250 and 101,250 candelas (as indicated by the number 30), approved in accordance with the 03 series of amendments to Regulation No. 31 and incorporating a lens of plastic material;

A front fog lamp approved in accordance with the 04 series of amendments to Regulation No. 19 and incorporating a lens of plastic material;

A front direction indicator lamp of category 1a, approved in accordance with the 01 series of amendments to Regulation No. 6.

Figure 9  
**Lamp reciprocally incorporated with an HSB unit**

Example 1

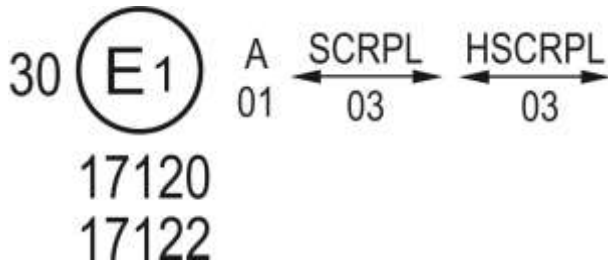

The above example corresponds to the marking of a lens of plastic material intended to be used in different types of HSB units, namely:

- Either: An HSB unit with a passing beam designed for right-hand and left-hand traffic and a driving beam approved in Germany (E 1) in accordance with the requirements of Regulation No. 5 as amended by the 03 series of amendments, which is reciprocally incorporated with a front position lamp approved in accordance with the 02 series of amendments to Regulation No. 7;
- Or: An HSB unit with a passing beam designed for right-hand and left-hand traffic and a driving beam with a maximum intensity comprised between 86,250 and 101,250 candelas, approved in Germany (E 1) in accordance with the requirements of Germany (E 1) in accordance with the requirements of Regulation No. 31 as amended by the 03 series of amendments which is reciprocally incorporated with the same front position lamp as above;
- Or even: Either of the above-mentioned HSB units approved as a single lamp.

The main body of the optical unit shall bear the only valid approval number, for instance:

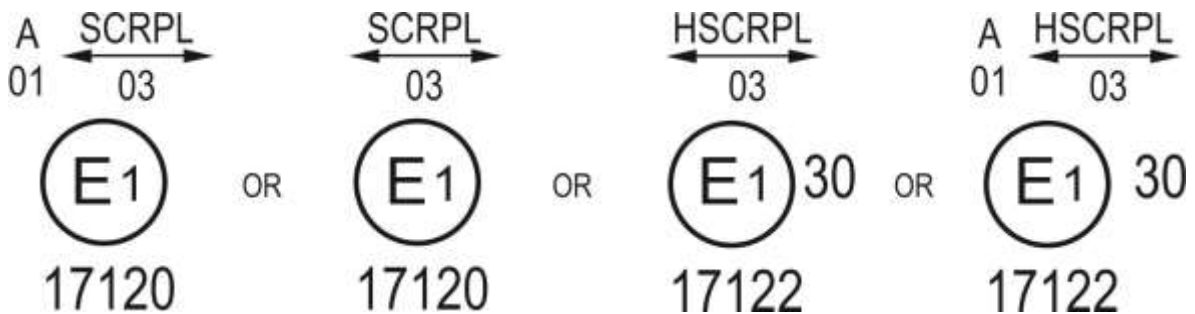



Example 2

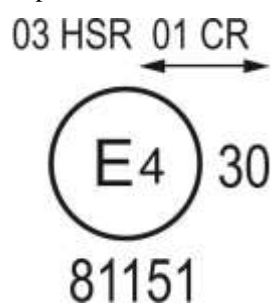

The above example corresponds to the marking of a lens used in an assembly of two HSB optical units approved in the Netherlands (E 4), consisting of a headlamp emitting a passing beam designed for both traffic systems and of a driving beam meeting the requirements of Regulation No. 1, and of a headlamp emitting a driving beam meeting the requirements of Regulation No. 31.

## Annex 3

### Electrical connections of HSB units

Figure 1  
Category 1  
(Driving only)

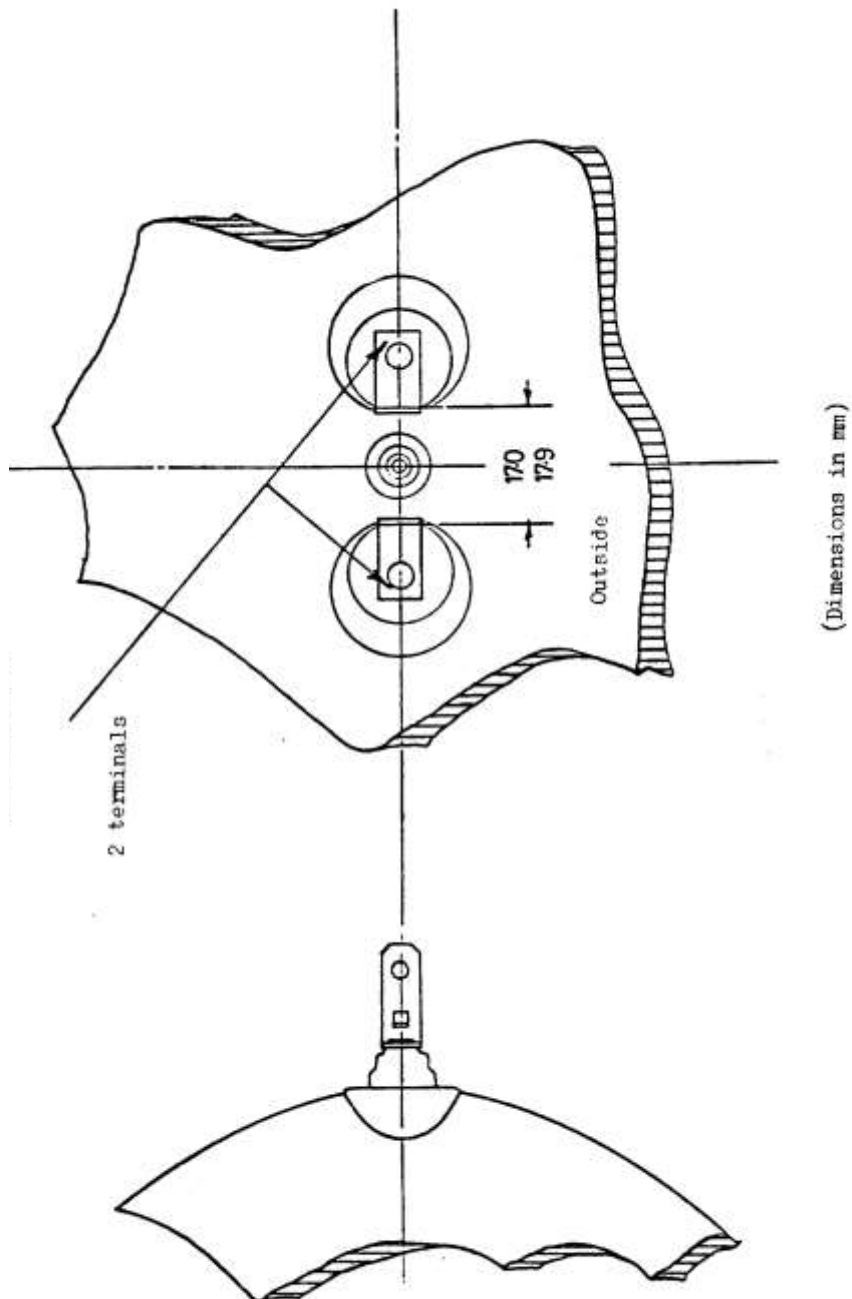

Figure 2  
Category 21  
(Passing only)

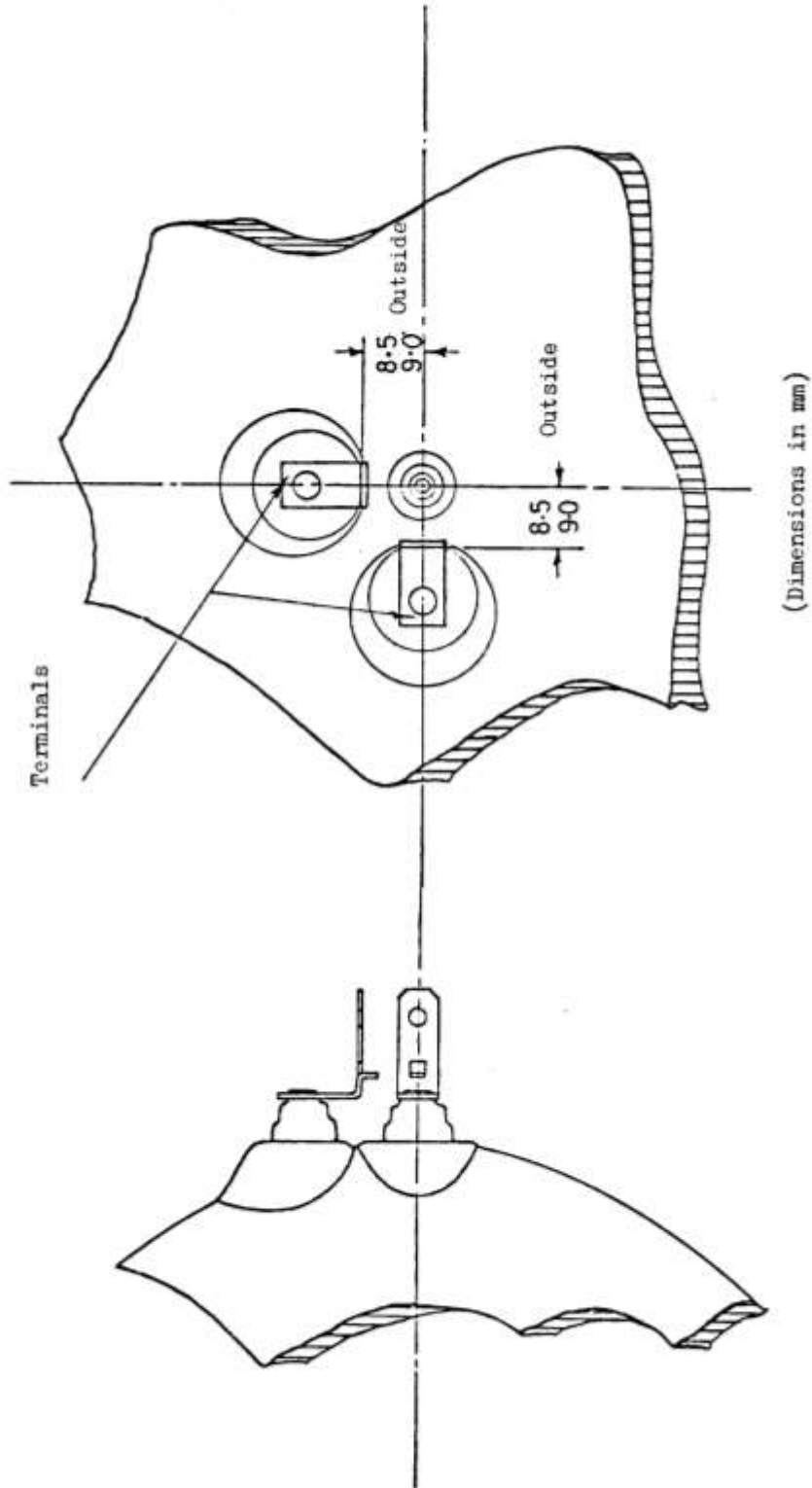
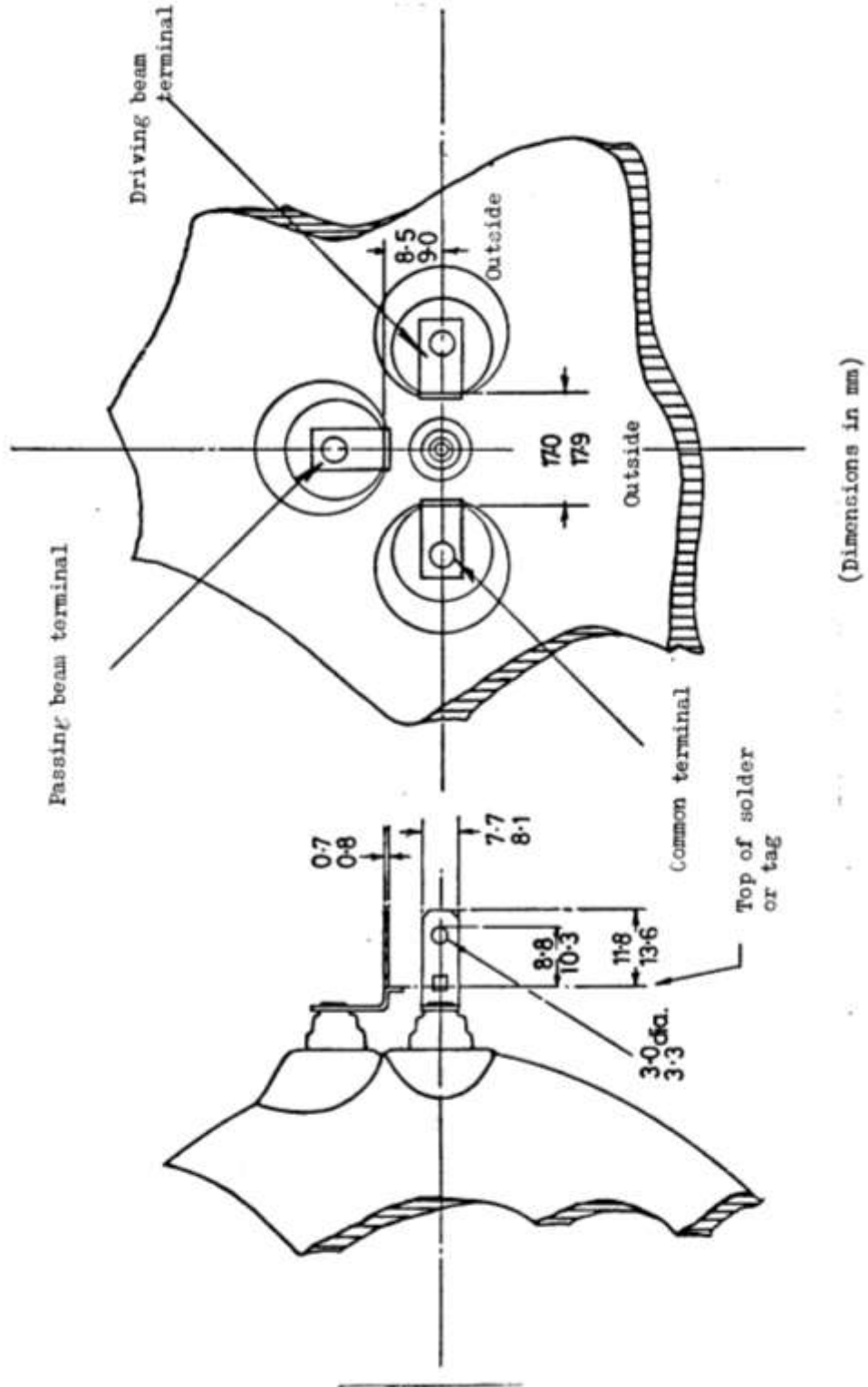

Figure 3  
 Category 22  
 (Passing and driving)



Annex 4

Measuring screen

A. HSB unit for right-hand traffic

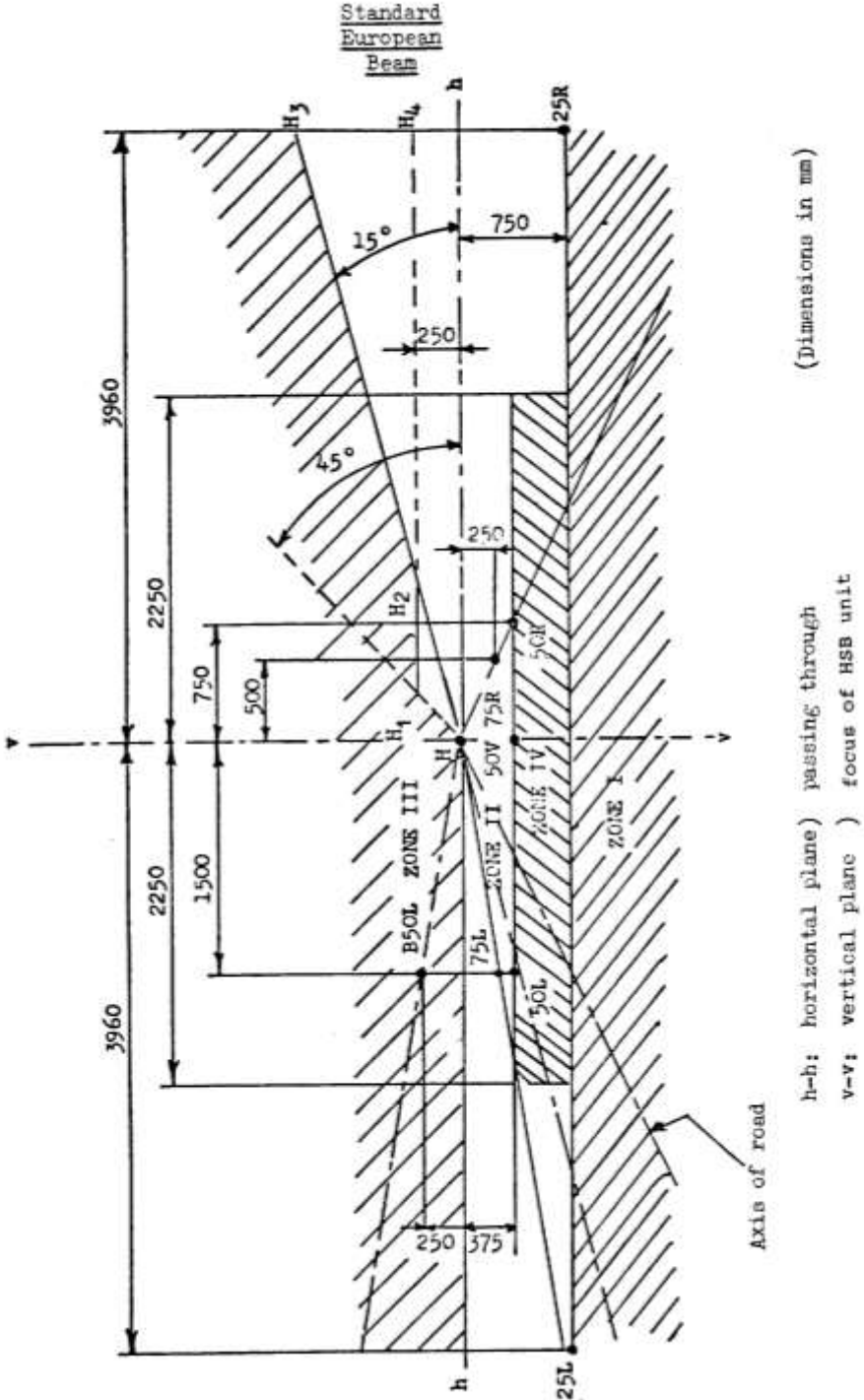

(Dimensions in mm)

h-h: horizontal plane) passing through  
 v-v: vertical plane ) focus of HSB unit

Axis of road

B. HSB unit for left-hand traffic

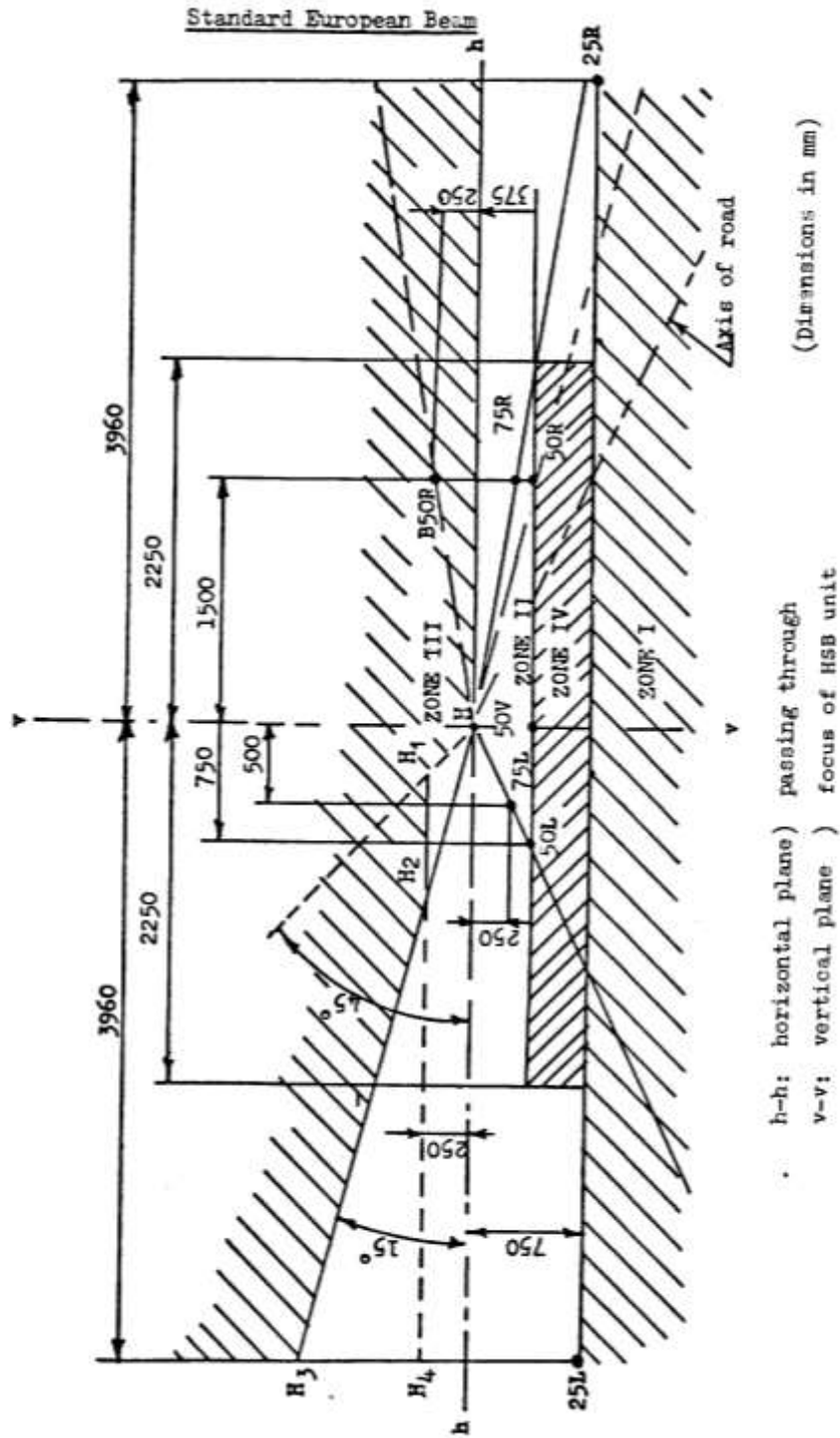

## Annex 5

### Minimum requirements for conformity of production control procedures

1. General
  - 1.1. The conformity requirements shall be considered satisfied from a mechanical and geometric standpoint, if the differences do not exceed inevitable manufacturing deviations within the requirements of this Regulation.
  - 1.2. With respect to photometric performances, the conformity of mass-produced headlamps shall not be contested if, when testing photometric performances of any headlamp chosen at random:
    - 1.2.1. No measured value deviates unfavourably by more than 20 per cent from the values prescribed in this Regulation. For values B 50 L (or R) and zone III, the maximum unfavourable deviation may be respectively:

B 50 L (or R) :	0.2 lx equivalent 20 per cent
	0.3 lx equivalent 30 per cent
Zone III:	0.3 lx equivalent 20 per cent
	0.45 lx equivalent 30 per cent
    - 1.2.2. Or if
      - 1.2.2.1. For the passing beam, the values prescribed in this Regulation are met at HV (with a tolerance of + 0.2 lx) and related to that aiming at least one point of each area delimited on the measuring screen (at 25 m) by a circle 15 cm in radius around points B 50 L (or R)<sup>1</sup> (with a tolerance of + 0.1 lx), 75 R (or L), 50 V, 25 R, 25 L, and in the entire area of zone IV which is not more than 22.5 cm above line 25 R and 25 L;
      - 1.2.2.2. And if, for the driving beam, HV being situated within the isolux  $0.75 E_{\max}$ , a tolerance of + 20 per cent for maximum values and - 20 per cent for minimum values is observed for the photometric values at any measuring point specified in paragraph 8.3. of this Regulation.
    - 1.2.3. If the results of the tests described above do not meet the requirements, the alignment of the headlamp may be changed, provided that the axis of the beam is not displaced laterally by more than 1° to the right or left.<sup>2</sup>
  - 1.3. With respect to the verification of the change in vertical position of the cut-off line under the influence of heat, the following procedure shall be applied:

<sup>1</sup> Letters in brackets refer to headlamps intended for left-hand traffic.

<sup>2</sup> The limit of realignment of 1° to the right or left is not incompatible with vertical realignment upward or downward. The latter is limited only by the requirements of paragraph 8.3. However, the horizontal part of the "cut-off" should not extend beyond the line hh (the provisions of paragraph 8.3. are not applicable to HSB units intended to meet the requirements of this Regulation only for provision of a passing beam).

One of the sampled headlamps shall be tested according to the procedure described in paragraph 2.1. of Annex 6 to this Regulation after being subjected three consecutive times to the cycle described in paragraph 2.2.2. of Annex 6 to this Regulation.

The headlamp shall be considered as acceptable if  $\Delta r$  does not exceed 1.5 mrad.

If this value exceeds 1.5 mrad but is not more than 2.0 mrad, a second headlamp shall be subjected to the test after which the mean of the absolute values recorded on both samples shall not exceed 1.5 mrad.

1.4. The chromaticity coordinates shall be complied with.

2. Minimum requirements for verification of conformity by the manufacturer

For each type of headlamp the holder of the approval mark shall carry out at least the following tests, at appropriate intervals. The tests shall be carried out in accordance with the provisions of this Regulation.

If any sampling shows non-conformity with regard to the type of test concerned, further samples shall be taken and tested. The manufacturer shall take steps to ensure the conformity of the production concerned.

2.1. Nature of tests

Tests of conformity in this Regulation shall cover the photometric characteristics and the verification of the change in vertical position of the cut-off line under the influence of heat.

2.2. Methods used in tests

2.2.1. Tests shall generally be carried out in accordance with the methods set out in this Regulation.

2.2.2. In any test of conformity carried out by the manufacturer, equivalent methods may be used with the consent of the Type Approval Authority responsible for approval tests. The manufacturer is responsible for proving that the applied methods are equivalent to those laid down in this Regulation.

2.2.3. The application of paragraphs 2.2.1. and 2.2.2. above requires regular calibration of test apparatus and its correlation with measurements made by a Type Approval Authority.

2.2.4. In all cases the reference methods shall be those of this Regulation, particularly for the purpose of administrative verification and sampling.

2.3. Nature of sampling

Samples of headlamps shall be selected at random from the production of a uniform batch. A uniform batch means a set of headlamps of the same type, defined according to the production methods of the manufacturer.

The assessment shall in general cover series production from individual factories. However, a manufacturer may group together records concerning the same type from several factories, provided these operate under the same quality system and quality management.



2.4. Measured and recorded photometric characteristics

The sampled headlamp shall be subjected to photometric measurements at the points provided for in the Regulation, the reading being limited to points  $E_{\max}$ , HV<sup>3</sup>, HL, HR<sup>4</sup> in the case of the driving beam, and to points B 50 L (or R), HV, 50 V, 75 R (or L) and 25 L (or R) in the case of the passing beam (see Figure in Annex 4 to this Regulation).

2.5. Criteria governing acceptability

The manufacturer is responsible for carrying out a statistical study of the test results and for defining, in agreement with the Type Approval Authority, criteria governing the acceptability of his products in order to meet the specifications laid down for verification of conformity of products in paragraph 11.1. of this Regulation.

The criteria governing the acceptability shall be such that, with a confidence level of 95 per cent, the minimum probability of passing a spot check in accordance with Annex 8 to this Regulation (first sampling) would be 0.95.

---

<sup>3</sup> When the driving beam is reciprocally incorporated with the passing beam, HV in the case of the driving beam shall be the same measuring point as in the case of the passing beam.

<sup>4</sup> HL and HR: points on "hh" located at 1.125 m to the left and to the right of point HV respectively.

## Annex 6

### Tests for stability of photometric performance of headlamps in operation

#### Tests on complete headlamps

Once the photometric values have been measured according to the prescriptions of this Regulation, in points for  $E_{\max}$  for driving beam and HV, 50 R, B 50 L for passing beam (or HV, 50 L, B 50 R for headlamps designed for left-hand traffic) a complete headlamp sample shall be tested for stability of photometric performance in operation. "Complete headlamp" shall be understood to mean the complete lamp itself including those surrounding body parts and lamps which could influence its thermal dissipation.

#### 1. Test of stability of photometric performance

The tests shall be carried out in a dry and still atmosphere at an ambient temperature of  $23\text{ °C} \pm 5\text{ °C}$ , the complete headlamp being mounted on a base representing the correct installation on the vehicle.

#### 1.1. Clean headlamp

The headlamp shall be operated for 12 hours as described in paragraph 1.1.1. below and checked as prescribed in paragraph 1.1.2 below.

#### 1.1.1. Test procedure

The headlamp shall be operated for a period according to the specified time, so that:

- 1.1.1.1. (a) In the case where only one lighting function (driving or passing beam) is to be approved, the corresponding filament is lit for the prescribed time,<sup>1</sup>
- (b) In the case of a reciprocally incorporated passing lamp and driving lamp (dual filament HSB headlamp):

If the applicant declares that the headlamp is to be used with a single filament lit<sup>2</sup> at a time, the test shall be carried out in accordance with this condition, activating<sup>1</sup> each specified function successively for half the time specified in paragraph 1.1. above;

In all other cases<sup>1, 2</sup>, the headlamp shall be subjected to the following cycle until the time specified is reached:

15 minutes, passing-beam filament lit

5 minutes, all filaments lit.

---

<sup>1</sup> When the tested headlamp is grouped and/or reciprocally incorporated with signalling lamps, the latter shall be lit for the duration of the test. In the case of a direction indicator lamp, it shall be lit in flashing operation mode with an on/off time ratio of approximately one to one.

<sup>2</sup> Should two filaments be simultaneously lit when headlamp flashing is used, this shall not be considered as being normal use of both filaments simultaneously.

- (c) In the case of grouped lighting functions all the individual functions shall be lit simultaneously for the time specified for individual lighting functions (a) also taking into account the use of reciprocally incorporated lighting functions (b), according to the manufacturer's specifications.
- 1.1.1.2. Test voltage
- The voltage shall be adjusted so as to supply 90 per cent of the maximum wattage specified in this Regulation for the type(s) of HSB headlamp(s) concerned is (are) obtained.
- 1.1.2. Test results
- 1.1.2.1. Visual inspection
- Once the headlamp has been stabilized to the ambient temperature, the headlamp lens and the external lens, if any, shall be cleaned with a clean, damp cotton cloth. It shall then be inspected visually; no distortion, deformation, cracking or change in colour of either the headlamp lens or the external lens, if any, shall be noticeable.
- 1.1.2.2. Photometric test
- To comply with the requirements of this Regulation, the photometric values shall be verified in the following points:
- Passing beam:
- 50 R - B 50 L - HV for headlamps designed for right-hand traffic
  - 50 L - B 50 R - HV for headlamps designed for left-hand traffic
- Driving beam:
- Point of  $E_{\max}$
- Another aiming may be carried out to allow for any deformation of the headlamp base due to heat (the change of the position of the cut-off line is covered in paragraph 2. of this annex);
- A 10 per cent discrepancy between the photometric characteristics and the values measured prior to the test is permissible including the tolerances of the photometric procedure.
- 1.2. Dirty headlamp
- After being tested as specified in paragraph 1.1. above, the headlamp shall be operated for one hour as described in paragraph 1.1.1. above, after being prepared as prescribed in paragraph 1.2.1. below, and checked as prescribed in paragraph 1.1.2. above.
- 1.2.1. Preparation of the headlamp
- 1.2.1.1. Test mixture
- 1.2.1.1.1. For headlamp with the outside lens in glass:
- The mixture of water and a polluting agent to be applied to the headlamp shall be composed of:
- 9 parts by weight of silica sand with a particle size of 0-100  $\mu\text{m}$ ,

1 part by weight of vegetal carbon dust (beechwood) with a particle size of 0-100 µm,  
0.2 part by weight of NaCMC,<sup>3</sup> and  
an appropriate quantity of distilled water, with a conductivity of ≤ 1 mS/m.

The mixture shall not be more than 14 days old.

1.2.1.1.2. For headlamp with outside lens in plastic material:

The mixture of water and polluting agent to be applied to the headlamp shall be composed of:

9 parts by weight of silica sand with a particle size of 0-100 µm,  
1 part by weight of vegetal carbon dust (beechwood) with a particle size of 0-100 µm,  
0.2 part by weight of NaCMC,<sup>3</sup>  
13 parts by weight of distilled water with a conductivity of ≤ 1 mS/m,  
and  
2 ± 1 parts by weight of surface-actant.<sup>4</sup>

The mixture shall not be more than 14 days old.

1.2.1.2. Application of the test mixture to the headlamp

The test mixture shall be uniformly applied to the entire light emitting surface of the headlamp and then left to dry. This procedure shall be repeated until the illumination value has dropped to 15-20 per cent of the values measured for each following point under the conditions described in paragraph 1 above:

Point of  $E_{\max}$  in driving beam, photometric distribution for a driving/passing lamp,

Point of  $E_{\max}$  in driving beam, photometric distribution for a driving lamp only,

50 R and 50 V<sup>5</sup> for a passing lamp only, designed for right-hand traffic,

50 L and 50 V<sup>5</sup> for a passing lamp only, designed for left-hand traffic.

1.2.1.3. Measuring equipment

The measuring equipment shall be equivalent to that used during headlamp approval tests.

---

<sup>3</sup> NaCMC represents the sodium salt of carboxymethylcellulose, customarily referred to as CMC. The NaCMC used in the dirt mixture shall have a degree of substitution (DS) of 0.6-0.7 and a viscosity of 200-300 cP for a 2 per cent solution at 20 °C.

<sup>4</sup> The tolerance on quantity is due to the necessity of obtaining a dirt that correctly spreads out on all the plastic lens.

<sup>5</sup> 50 V is situated 375 mm below HV on the vertical line v-v on the screen at 25 m distance.

2. Test for change in vertical position of the cut-off line under the influence of heat

This test consists of verifying that the vertical drift of the cut-off line under the influence of heat does not exceed a specified value for an operating passing lamp.

The headlamp tested in accordance with paragraph 1.1. above, shall be subjected to the test described in 2.1. below, without being removed from or readjusted in relation to its test fixture.

2.1. Test

The test shall be carried out in a dry and still atmosphere at an ambient temperature of  $23\text{ °C} \pm 5\text{ °C}$ .

Using a mass production HSB headlamp which has been aged for at least one hour, the headlamp shall be operated on passing beam without being dismantled from or readjusted in relation to its test fixture. (For the purpose of this test, the voltage shall be adjusted as specified in paragraph 1.1.1.2. above). The position of the cut-off line in its horizontal part (between vv and the vertical line passing through point B 50 L for right-hand traffic or B 50 R for left-hand traffic) shall be verified 3 minutes ( $r_3$ ) and 60 minutes ( $r_{60}$ ) respectively after operation.

The measurement of the variation in the cut-off line position as described above shall be carried out by any method giving acceptable accuracy and reproducible results.

2.2. Test results

2.2.1. The result expressed in milliradians (mrad) shall be considered as acceptable when the absolute value  $\Delta r_1 = |r_3 - r_{60}|$  recorded on the headlamp is not more than 1.0 mrad ( $\Delta r_1 \leq 1.0\text{ mrad}$ ).

2.2.2. However, if this value is more than 1.0 mrad but not more than 1.5 mrad ( $1.0\text{ mrad} \leq \Delta r_1 \leq 1.5\text{ mrad}$ ) a second headlamp shall be tested as described in paragraph 2.1. above after being subjected three consecutive times to the cycle as described below, in order to stabilize the position of mechanical parts of the headlamp on a base representative of the correct installation on the vehicle:

Operation of the passing lamp for one hour, (the voltage shall be adjusted as specified in paragraph 1.1.1.2. above),

Period of rest for one hour.

The headlamp type shall be considered as acceptable if the mean value of the absolute values  $\Delta r_I$  measured on the first sample and  $\Delta r_{II}$  measured on the second sample is not more than 1.0 mrad

$$\frac{(\Delta r_I + \Delta r_{II})}{2} \leq 1.0\text{ mrad}$$

## Annex 7

### Requirements for lamps incorporating lenses of plastic material - testing of lens or material samples and of complete lamps

1. General specifications
  - 1.1. The samples supplied pursuant to paragraph 3.2.4. of this Regulation shall satisfy the specifications indicated in paragraphs 2.1. to 2.5. below.
  - 1.2. Two out of the five samples of complete lamps supplied pursuant to paragraph 3.2.3. of this Regulation and incorporating lenses of plastic material shall, with regard to the lens material, satisfy the specifications indicated in paragraph 2.6. below.
  - 1.3. The samples of lenses of plastic material or samples of material shall be subjected, with the reflector to which they are intended to be fitted (where applicable), to approval tests in the chronological order indicated in table A reproduced in Appendix 1 to this annex.
  - 1.4. However, if the lamp manufacturer can prove that the product has already passed the tests prescribed in paragraphs 2.1.-2.5. below, or the equivalent tests pursuant to another Regulation, those tests need not be repeated; only the tests prescribed in Appendix 1, table B, shall be mandatory.

#### 2. Tests

##### 2.1. Resistance to temperature changes

##### 2.1.1. Tests

Three new samples (lenses) shall be subjected to five cycles of temperature and humidity (RH = relative humidity) change in accordance with the following programme:

3 hours at  $40\text{ °C} \pm 2\text{ °C}$  and 85 - 95 per cent RH;

1 hour at  $23\text{ °C} \pm 5\text{ °C}$  and 60 - 75 per cent RH;

15 hours at  $-30\text{ °C} \pm 2\text{ °C}$ ;

1 hour at  $23\text{ °C} \pm 5\text{ °C}$  and 60 - 75 per cent RH;

3 hours at  $80\text{ °C} \pm 2\text{ °C}$ ;

1 hour at  $23\text{ °C} \pm 5\text{ °C}$  and 60 - 75 per cent RH.

Before this test, the samples shall be kept at  $23\text{ °C} \pm 5\text{ °C}$  and 60-75 per cent RH for at least four hours.

*Note:* The periods of one hour at  $23\text{ °C} \pm 5\text{ °C}$  shall include the periods of transition from one temperature to another which are needed in order to avoid thermal shock effects.

2.1.2. Photometric measurements

2.1.2.1. Method

Photometric measurements shall be carried out on the samples before and after the test.

These measurements shall be made using a standard lamp, at the following points:

B 50 L and 50 R for the passing beam of a passing lamp or a passing/driving lamp (B 50 R and 50 L in the case of headlamps intended for left-hand traffic);

E<sub>max</sub> route for the driving beam of a driving lamp or a passing/driving lamp.

2.1.2.2. Results

The variation between the photometric values measured on each sample before and after the test shall not exceed 10 per cent including the tolerances of the photometric procedure.

2.2. Resistance to atmospheric and chemical agents

2.2.1. Resistance to atmospheric agents

Three new samples (lenses or samples of material) shall be exposed to radiation from a source having a spectral energy distribution similar to that of a black body at a temperature between 5,500K and 6,000K. Appropriate filters shall be placed between the source and the samples so as to reduce as far as possible radiations with wave lengths smaller than 295 nm and greater than 2,500 nm. The samples shall be exposed to an energetic illumination of  $1,200 \text{ W/m}^2 \pm 200 \text{ W/m}^2$  for a period such that the luminous energy that they receive is equal to  $4,500 \text{ MJ/m}^2 \pm 200 \text{ MJ/m}^2$ . Within the enclosure, the temperature measured on the black panel placed on a level with the samples shall be  $50 \text{ }^\circ\text{C} \pm 5 \text{ }^\circ\text{C}$ . In order to ensure a regular exposure, the samples shall revolve around the source of radiation at a speed between 1 and 5 1/min.

The samples shall be sprayed with distilled water of conductivity lower than 1 mS/m at a temperature of  $23 \text{ }^\circ\text{C} \pm 5 \text{ }^\circ\text{C}$ , in accordance with the following cycle:

spraying: 5 minutes;

drying: 25 minutes.

2.2.2. Resistance to chemical agents

After the test described in paragraph 2.2.1. above and the measurement described in paragraph 2.2.3.1. below have been carried out, the outer face of the said three samples shall be treated as described in paragraph 2.2.2.2. with the mixture defined in paragraph 2.2.2.1. below.

2.2.2.1. Test mixture

The test mixture shall be composed of 61.5 per cent n-heptane, 12.5 per cent toluene, 7.5 per cent ethyl tetrachloride, 12.5 per cent trichloroethylene and 6 per cent xylene (volume per cent).

2.2.2.2. Application of the test mixture

Soak a piece of cotton cloth (as per ISO 105) until saturation with the mixture defined in paragraph 2.2.2.1. above and, within 10 seconds, apply it for 10 minutes to the outer face of the sample at a pressure of 50 N/cm<sup>2</sup>, corresponding to an effort of 100 N applied on a test surface of 14 x 14 mm.

During this 10-minute period, the cloth pad shall be soaked again with the mixture so that the composition of the liquid applied is continuously identical with that of the test mixture prescribed.

During the period of application, it is permissible to compensate the pressure applied to the sample in order to prevent it from causing cracks.

2.2.2.3. Cleaning

At the end of the application of the test mixture, the samples shall be dried in the open air and then washed with the solution described in paragraph 2.3. below (Resistance to detergents) at 23 °C ± 5 °C.

Afterwards the samples shall be carefully rinsed with distilled water containing not more than 0.2 per cent impurities at 23 °C ± 5 °C and then wiped off with a soft cloth.

2.2.3. Results

2.2.3.1. After the test of resistance to atmospheric agents, the outer face of the samples shall be free from cracks, scratches, chipping and deformation, and

the mean variation in transmission  $\Delta t = \frac{T_2 - T_3}{T_2}$ , measured on the three

samples according to the procedure described in Appendix 2 to this annex shall not exceed 0.020 ( $\Delta t_m \leq 0.020$ ).

2.2.3.2. After the test of resistance to chemical agents, the samples shall not bear any traces of chemical staining likely to cause a variation of flux diffusion, whose

mean variation  $\Delta d = \frac{T_5 - T_4}{T_2}$ , measured on the three samples according

to the procedure described in Appendix 2 to this annex shall not exceed 0.020 ( $\Delta d_m \leq 0.020$ ).

2.3. Resistance to detergents and hydrocarbons

2.3.1. Resistance to detergents

The outer face of three samples (lenses or samples of material) shall be heated to 50 °C ± 5 °C and then immersed for five minutes in a mixture maintained at 23 °C ± 5 °C and composed of 99 parts distilled water containing not more than 0.02 per cent impurities and one part alkylaryl sulphonate.

At the end of the test, the samples shall be dried at 50 °C ± 5 °C. The surface of the samples shall be cleaned with a moist cloth.

2.3.2. Resistance to hydrocarbons

The outer face of these three samples shall then be lightly rubbed for one minute with a cotton cloth soaked in a mixture composed of 70 per cent n-heptane and 30 per cent toluene (volume per cent), and shall then be dried in the open air.



2.3.3. Results

After the above two tests have been performed successively, the mean value of the variation in transmission  $\Delta t = \frac{T_2 - T_3}{T_2}$ , measured on the three samples according to the procedure described in Appendix 2 to this annex shall not exceed 0.010 ( $\Delta t_m \leq 0.010$ ).

2.4. Resistance to mechanical deterioration

2.4.1. Mechanical deterioration method

The outer face of the three new samples (lenses) shall be subjected to the uniform mechanical deterioration test by the method described in Appendix 3 to this annex.

2.4.2. Results

After this test, the variations:

in transmission:  $\Delta t = \frac{T_2 - T_3}{T_2}$ ,

and in diffusion:  $\Delta d = \frac{T_5 - T_4}{T_2}$ ,

shall be measured according to the procedure described in Appendix 2 in the area specified in paragraph 3.2.4.1.1. of this Regulation. The mean value of the three samples shall be such that:  $\Delta t_m \leq 0.100$

$$\Delta d_m \leq 0.050.$$

2.5. Test of adherence of coatings, if any

2.5.1. Preparation of the sample

A surface of 20 mm x 20 mm in area of the coating of a lens shall be cut with a razor blade or a needle into a grid of squares approximately 2 mm x 2 mm. The pressure on the blade or needle shall be sufficient to cut at least the coating.

2.5.2. Description of the test

Use an adhesive tape with a force adhesion of 2 N/(cm of width)  $\pm$  20 per cent measured under the standardized conditions specified in Appendix 4 to this annex. This adhesive tape, which shall be at least 25 mm wide, shall be pressed for at least five minutes to the surface prepared as prescribed in paragraph 2.5.1. above.

Then the end of the adhesive tape shall be loaded in such a way that the force of adhesion to the surface considered is balanced by a force perpendicular to that surface. At this stage, the tape shall be torn off at a constant speed of 1.5 m/s  $\pm$  0.2 m/s.

- 2.5.3. Results
- There shall be no appreciable impairment of the gridded area. Impairments at the intersections between squares or at the edges of the cuts shall be permitted, provided that the impaired area does not exceed 15 per cent of the gridded surface.
- 2.6. Tests of the complete lamp incorporating a lens of plastic material
- 2.6.1. Resistance to mechanical deterioration of the lens surface
- 2.6.1.1. Tests
- The lens of lamp sample No. 1 shall be subjected to the test described in paragraph 2.4.1. above.
- 2.6.1.2. Results
- After the test, the results of photometric measurements carried out on the lamp in accordance with this Regulation shall not exceed by more than 30 per cent the maximum values prescribed at points B 50 L and HV and not be more than 10 per cent below the minimum values prescribed at point 75 R (in the case of headlamps intended for left-hand traffic, the points to be considered are B 50 R, HV and 75 L).
- 2.6.2. Test of adherence of coatings, if any
- The lens of lamp sample No. 2 shall be subjected to the test described in paragraph 2.5. above.
3. Verification of the conformity of production
- 3.1. With regard to the materials used for the manufacture of lenses, the lamps of a series shall be recognized as complying with this Regulation if:
- 3.1.1. After the test for resistance to chemical agents and the test for resistance to detergents and hydrocarbons, the outer face of the samples exhibits no cracks, chipping or deformation visible to the naked eye (see paragraphs 2.2.2., 2.3.1. and 2.3.2. above);
- 3.1.2. After the test described in paragraph 2.6.1.1. above, the photometric values at the points of measurement considered in paragraph 2.6.1.2. above are within the limits prescribed for conformity of production by this Regulation.
- 3.2. If the test results fail to satisfy the requirements, the tests shall be repeated on another sample of headlamps selected at random.

## Annex 7 - Appendix 1

### Chronological order of approval tests

A. Tests on plastic materials (lenses or samples of material supplied pursuant to paragraph 3.2.4. of this Regulation)

<i>Samples</i>	<i>Lenses or samples of material</i>										<i>Lenses</i>		
	<i>1</i>	<i>2</i>	<i>3</i>	<i>4</i>	<i>5</i>	<i>6</i>	<i>7</i>	<i>8</i>	<i>9</i>	<i>10</i>	<i>11</i>	<i>12</i>	<i>13</i>
1.1. Limited photometry (para. 2.1.2.)										X	X	X	
1.1.1. Temperature change (para. 2.1.1.)										X	X	X	
1.2. Limited photometry (para. 2.1.2.)										X	X	X	
1.2.1. Transmission measurement	X	X	X	X	X	X	X	X	X				
1.2.2. Diffusion measurement	X	X	X				X	X	X				
1.3. Atmospheric agents (para. 2.2.1.)	X	X	X										
1.3.1. Transmission measurement	X	X	X										
1.4. Chemical agents (para. 2.2.2.)	X	X	X										
1.4.1. Diffusion measurement	X	X	X										
1.5. Detergents (para. 2.3.1.)				X	X	X							
1.6. Hydrocarbons (para. 2.3.2.)				X	X	X							
1.6.1. Transmission measurement				X	X	X							
1.7. Deterioration (para. 2.4.1.)							X	X	X				
1.7.1. Transmission measurement							X	X	X				
1.7.2. Diffusion measurement							X	X	X				
1.8. Adherence (para. 2.5.)													X

B. Tests on complete headlamps (supplied pursuant to paragraph 3.2.3. of this Regulation)

<i>Tests</i>	<i>Complete headlamp</i>	
	<i>Sample No.</i>	
	<i>1</i>	<i>2</i>
2.1. Deterioration (para. 2.6.1.1)	X	
2.2. Photometry (para. 2.6.1.2)	X	
2.3. Adherence (para. 2.6.2)		X

## Annex 7 - Appendix 2

### Method of measurement of the diffusion and transmission of light

1. Equipment (see figure below)

The beam of a collimator K with a half divergence  $\frac{\beta}{2} = 17.4 \times 10^{-4}$  rad is limited by a diaphragm  $D_T$  with an opening of 6 mm against which the sample stand is placed.

A convergent achromatic lens  $L_2$ , corrected for spherical aberrations, links the diaphragm  $D_T$  with the receiver R; the diameter of the lens  $L_2$  shall be such that it does not diaphragm the light diffused by the sample in a cone with a half top angle of  $\beta/2 = 14^\circ$ .

An annular diaphragm  $D_D$  with angles  $\frac{\alpha_a}{2} = 1^\circ$  and  $\frac{\alpha_{\max}}{2} = 12^\circ$  is placed in an image focal plane of the lens  $L_2$ .

The non-transparent central part of the diaphragm is necessary in order to eliminate the light arriving directly from the light source. It shall be possible to remove the central part of the diaphragm from the light beam in such a manner that it returns exactly to its original position.

The distance  $L_2 D_T$  and the focal length  $F_2$ <sup>1</sup> of the lens  $L_2$  shall be so chosen that the image of  $D_T$  completely covers the receiver R.

When the initial incident flux is referred to 1,000 units, the absolute precision of each reading shall be better than 1 unit.

2. Measurements

The following readings shall be taken:

<i>Reading</i>	<i>With sample</i>	<i>With central part of <math>D_D</math></i>	<i>Quantity represented</i>
T <sub>1</sub>	No	No	Incident flux in initial reading
T <sub>2</sub>	Yes (before test)	No	Flux transmitted by the new material in a field of 24 °C
T <sub>3</sub>	Yes (after test)	No	Flux transmitted by the tested material in a field of 24 °C
T <sub>4</sub>	Yes (before test)	Yes	Flux diffused by the new material
T <sub>5</sub>	Yes (after test)	Yes	Flux diffused by the tested material

<sup>1</sup> For  $L_2$  it is recommended to use a focal distance of about 80 mm.

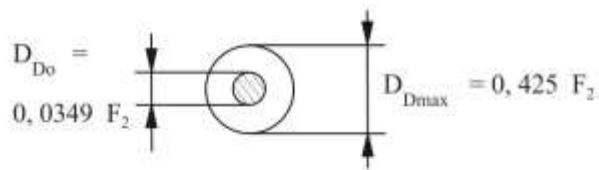
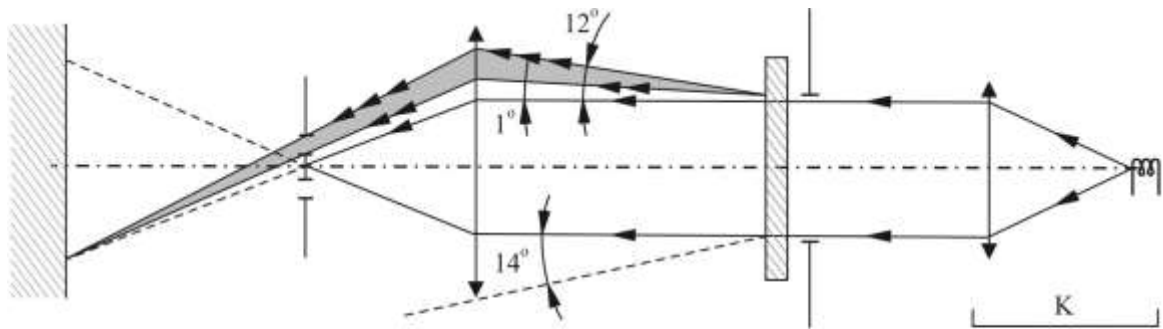

## Annex 7 – Appendix 3

### Spray testing method

1. Test equipment

1.1. Spray gun

The spray gun used shall be equipped with a nozzle 1.3 mm in diameter allowing a liquid flow rate of  $0.24 \pm 0.02$  l/minute at an operating pressure of 6.0 bars - 0, + 0.5 bar.

Under these operation conditions the fan pattern obtained shall be  $170 \text{ mm} \pm 50 \text{ mm}$  in diameter on the surface exposed to deterioration, at a distance of  $380 \text{ mm} \pm 10 \text{ mm}$  from the nozzle.

1.2. Test mixture

The test mixture shall be composed of:

Silica sand of hardness 7 on the Mohr scale, with a grain size between 0 and 0.2 mm and an almost normal distribution, with an angular factor of 1.8 to 2;

Water of hardness not exceeding  $205 \text{ g/m}^3$  for a mixture comprising 25 g of sand per litre of water.

2. Test

The outer surface of the lamp lenses shall be subjected once or more than once to the action of the sand jet produced as described above. The jet shall be sprayed almost perpendicular to the surface to be tested.

The deterioration shall be checked by means of one or more samples of glass placed as a reference near the lenses to be tested. The mixture shall be sprayed until the variation in the diffusion of light on the sample or samples measured by the method described in Appendix 2 to this annex, is such that:

$$\Delta d = \frac{T_5 - T_4}{T_2} = 0.0250 \pm 0.0025.$$

Several reference samples may be used to check that the whole surface to be tested has deteriorated homogeneously.

## Annex 7 - Appendix 4

### Adhesive tape adherence test

1. Purpose  
This method allows to determine under standard conditions the linear force of adhesion of an adhesive tape to a glass plate.
2. Principle  
Measurement of the force necessary to unstick an adhesive tape from a glass plate at an angle of 90°.
3. Specified atmospheric conditions  
The ambient conditions shall be at 23 °C ± 5 °C and 65 ± 15 per cent relative humidity (RH).
4. Test pieces  
Before the test, the sample roll of adhesive tape shall be conditioned for 24 hours in the specified atmosphere (see paragraph 3. above).  
Five test pieces each 400 mm long shall be tested from each roll. These test pieces shall be taken from the roll after the first three turns were discarded.
5. Procedure  
The test shall be under the ambient conditions specified in paragraph 3 above.  
Take the five test pieces while unrolling the tape radially at a speed of approximately 300 mm/s, then apply them within 15 seconds in the following manner:  
Apply the tape to the glass plate progressively with a slight lengthwise rubbing movement of the finger, without excessive pressure, in such a manner as to leave no air bubble between the tape and the glass plate.  
Leave the assembly in the specified atmospheric conditions for 10 minutes.  
Unstick about 25 mm of the test piece from the plate in a plane perpendicular to the axis of the test piece.  
Fix the plate and fold back the free end of the tape at 90°. Apply force in such a manner that the separation line between the tape and the plate is perpendicular to this force and perpendicular to the plate.  
Pull to unstick at a speed of 300 mm/s ± 30 mm/s and record the force required.
6. Results  
The five values obtained shall be arranged in order and the median value taken as the result of the measurement. This value shall be expressed in Newtons per centimetre of width of the tape.

## Annex 8

### Minimum requirements for sampling by an inspector

1. General
  - 1.1. The conformity requirements shall be considered satisfied from a mechanical and a geometric standpoint, in accordance with the requirements of this Regulation, if any, if the differences do not exceed inevitable manufacturing deviations.
  - 1.2. With respect to photometric performance, the conformity of mass-produced headlamps shall not be contested if, when testing photometric performances of any headlamp chosen at random:
    - 1.2.1. No measured value deviates unfavourably by more than 20 per cent from the values prescribed in this Regulation.  
  
For values B 50 L (or R) and Zone III the maximum deviation may be respectively:

B 50 L (or R) :	0.2	lx equivalent 20 per cent
	0.3	lx equivalent 30 per cent
Zone III:	0.3	lx equivalent 20 per cent
	0.45	lx equivalent 30 per cent
    - 1.2.2. Or if
      - 1.2.2.1. For the passing beam, the values prescribed in this Regulation are met at HV (with a tolerance of 0.2 lx) and related to that aiming at least one point of each area delimited on the measuring screen (at 25 m) by a circle 15 cm in radius around points B 50 L (or R)<sup>1</sup> (with a tolerance of 0.1 lx), 75 R (or L), 50 V, 25 R, 25 L, and in the entire area of zone IV which is not more than 22.5 cm above line 25 R and 25 L;
      - 1.2.2.2. And if, for the driving beam, HV being situated within the isolux 0.75 E<sub>max</sub>, a tolerance of +20 per cent for maximum values and - 20 per cent for minimum values is observed for the photometric values at any measuring point specified in paragraph 8.3. of this Regulation. The reference mark is disregarded.
    - 1.2.3. If the results of the tests described above do not meet the requirements, the alignment of the headlamp may be changed, provided that the axis of the beam is not displaced laterally by more than 1° to the right or left.<sup>2</sup>
    - 1.2.4. Headlamps with apparent defects are disregarded.

---

<sup>1</sup> Letters in brackets refer to headlamps intended for left-hand traffic.

<sup>2</sup> The limit of realignment of 1° to the right or left is not incompatible with vertical realignment upward or downward. The latter is limited only by the requirements of paragraph 8.3. However, the horizontal part of the "cut-off" should not extend beyond the line hh (the provisions of paragraph 8.3. are not applicable to HSB units intended to meet the requirements of this Regulation only for provision of a passing beam).



- 1.2.5. The reference mark is disregarded.
- 1.3. The chromaticity coordinates shall be complied with.
2. First sampling
- In the first sampling four headlamps are selected at random. The first sample of two is marked A, the second sample of two is marked B.
- 2.1. The conformity is not contested
- 2.1.1. Following the sampling procedure shown in Figure 1 of this annex the conformity of mass-produced headlamps shall not be contested if the deviation of the measured values of the headlamps in the unfavourable directions are:
- 2.1.1.1. Sample A
- |     |                |               |             |
|-----|----------------|---------------|-------------|
| A1: | one headlamp   |               | 0 per cent  |
|     | one headlamp   | not more than | 20 per cent |
| A2: | both headlamps | more than     | 0 per cent  |
|     | but            | not more than | 20 per cent |
|     | go to sample B |               |             |
- 2.1.1.2. Sample B
- |     |                |  |            |
|-----|----------------|--|------------|
| B1: | both headlamps |  | 0 per cent |
|-----|----------------|--|------------|
- 2.1.2. Or, if the conditions of paragraph 1.2.2. above for sample A are fulfilled.
- 2.2. The conformity is contested
- 2.2.1. Following the sampling procedure shown in Figure 1 of this annex the conformity of mass-produced headlamps shall be contested and the manufacturer requested to make his production meet the requirements (alignment) if the deviations of the measured values of the headlamps are:
- 2.2.1.1. Sample A
- |     |              |               |             |
|-----|--------------|---------------|-------------|
| A3: | one headlamp |               | 20 per cent |
|     | one headlamp | more than     | 20 per cent |
|     | but          | not more than | 30 per cent |
- 2.2.1.2. Sample B
- |     |                   |               |             |
|-----|-------------------|---------------|-------------|
| B2: | in the case of A2 |               |             |
|     | one headlamp      | more than     | 0 per cent  |
|     | but               | not more than | 20 per cent |
|     | one headlamp      | not more than | 20 per cent |
| B3: | in the case of A2 |               |             |
|     | one headlamp      |               | 0 per cent  |
|     | one headlamp      | more than     | 20 per cent |
|     | but               | not more than | 30 per cent |
- 2.2.2. Or, if the conditions of paragraph 1.2.2. above for sample A are not fulfilled.

- 2.3. Approval withdrawn
- Conformity shall be contested and paragraph 12. of this Regulation applied if, following the sampling procedure in Figure 1 of this annex, the deviations of the measured values of the headlamps are:
- 2.3.1. Sample A
- |     |                |               |             |
|-----|----------------|---------------|-------------|
| A4: | one headlamp   | not more than | 20 per cent |
|     | one headlamp   | more than     | 30 per cent |
| A5: | both headlamps | more than     | 20 per cent |
- 2.3.2. Sample B
- |     |                   |               |             |
|-----|-------------------|---------------|-------------|
| B4: | in the case of A2 |               |             |
|     | one headlamp      | more than     | 0 per cent  |
|     | but               | not more than | 20 per cent |
|     | one headlamp      | more than     | 20 per cent |
| B5: | in the case of A2 |               |             |
|     | both headlamps    | more than     | 20 per cent |
| B6: | in the case of A2 |               |             |
|     | one headlamp      |               | 0 per cent  |
|     | one headlamp      | more than     | 30 per cent |
- 2.3.3. Or, if the conditions of paragraph 1.2.2. above for samples A and B are not fulfilled.
3. Repeated sampling
- In the cases of A3, B2, B3 a repeated sampling, third sample C of two headlamps and fourth sample D of two headlamps, selected from stock manufactured after alignment, is necessary within two months' time after the notification.
- 3.1. The conformity is not contested
- 3.1.1. Following the sampling procedure shown in Figure 1 of this annex the conformity of mass-produced headlamps shall not be contested if the deviations of the measured values of the headlamps are:
- 3.1.1.1. Sample C
- |     |                |               |             |
|-----|----------------|---------------|-------------|
| C1: | one headlamp   |               | 0 per cent  |
|     | one headlamp   | not more than | 20 per cent |
| C2: | both headlamps | more than     | 0 per cent  |
|     | but            | not more than | 20 per cent |
|     | go to sample D |               |             |
- 3.1.1.2. Sample D
- |     |                   |  |            |
|-----|-------------------|--|------------|
| D1: | in the case of C2 |  |            |
|     | both headlamps    |  | 0 per cent |
- 3.1.2. Or, if the conditions of paragraph 1.2.2. above for sample C are fulfilled.

- 3.2. The conformity is contested
- 3.2.1. Following the sampling procedure shown in Figure 1 of this annex the conformity of mass-produced headlamps shall be contested and the manufacturer requested to make his production meet the requirements (alignment) if the deviations of the measured values of the headlamps are:
- 3.2.1.1. Sample D
- |                       |               |             |
|-----------------------|---------------|-------------|
| D2: in the case of C2 |               |             |
| one headlamp          | more than     | 0 per cent  |
| but not               | more than     | 20 per cent |
| one headlamp          | not more than | 20 per cent |
- 3.2.1.2. Or, if the conditions of paragraph 1.2.2. above for sample C are not fulfilled.
- 3.3. Approval withdrawn
- Conformity shall be contested and paragraph 12. of this Regulation applied if, following the sampling procedure in Figure 1 of this annex, the deviations of the measured values of the headlamps are:
- 3.3.1. Sample C
- |                    |               |             |
|--------------------|---------------|-------------|
| C3: one headlamp   | not more than | 20 per cent |
| one headlamp       | more than     | 20 per cent |
| C4: both headlamps | more than     | 20 per cent |
- 3.3.2. Sample D
- |                       |           |             |
|-----------------------|-----------|-------------|
| D3: in the case of C2 |           |             |
| one headlamp 0 or     | more than | 0 per cent  |
| one headlamp          | more than | 20 per cent |
- 3.3.3. Or, if the conditions of paragraph 1.2.2. above for samples C and D are not fulfilled.
4. Change of the vertical position of the cut-off line
- With respect to the verification of the change in vertical positions of the cut-off line under the influence of heat, the following procedure shall be applied:
- One of the headlamps of sample A after sampling procedure in Figure 1 of this annex shall be tested according to the procedure described in paragraph 2.1. of Annex 6 to this Regulation after being subjected three consecutive times to the cycle described in paragraph 2.2.2. of Annex 6 to this Regulation.
- The headlamp shall be considered as acceptable if  $\Delta r$  does not exceed 1.5 mrad.
- If this value exceeds 1.5 mrad but is not more than 2.0 mrad, the second headlamp of sample A shall be subjected to the test after which the mean of the absolute values recorded in both samples shall not exceed 1.5 mrad.
- However, if this value of 1.5 mrad on sample A is not complied with, the two headlamps of sample B shall be subjected to the same procedure and the value of  $\Delta r$  for each of them shall not exceed 1.5 mrad.

Figure 1

