

## Committee of Experts on the Transport of Dangerous Goods and on the Globally Harmonized System of Classification and Labelling of Chemicals

Sub-Committee of Experts on the Globally Harmonized  
System of Classification and Labelling of Chemicals

7 December 2015

### Thirtieth session

Geneva, 9-11 December 2015

Item 4 (a) of the provisional agenda

**Hazard communication issues: labelling of small packagings**

## Labelling of small packagings

**Transmitted by the European Chemical Industry Council (CEFIC) on  
behalf of the informal correspondence group**

### Introduction

1. At its 29th session the Sub-Committee noted that the informal correspondence group intended to develop a third example addressing other labelling issues than the first and second ones and their possible solutions.

### Development of an example for sets or kits

2. The proposed third set of examples to be presented during the 30th session is to acquaint the correspondence group on labelling of small packaging with the issues surrounding sets or kits.

3. The proposed examples are to be reviewed by the informal correspondence group on labelling of small packaging at its meeting scheduled for 9 December 2015.

### Definition of sets or kits

4. A set or kit is a combination package, which includes two or more individual inner packages or single compartments with different components. Because of the variety they are divided as follows:

- (a) sets or kits with removable single containers;
- (b) sets or kits with single containers or individual chambers;
- (c) sets or kits with individual chambers where the dividing wall has to be punctured for mixing. Hereby results a hazardous mixture, which contains different hazards when compared to the original components (combination package).

5. Set or kits are subject to the provisions of the GHS if the combination package contains at least one hazardous substance or mixture.

## **Recommended procedure for sets or kits (combination packages)**

6. The number of hazardous single components contained within the set or kit relative to the physical size of the outer package is an important first step in determining the feasibility of labeling. If possible, all labelling information for each hazardous substance, mixture or article must be displayed on the outer package.

The supplier information need only appear once.

The GHS required labelling elements must be clearly and prominently displayed on a surface that is visible under normal conditions of use, easily legible without the aid of any device other than corrective lenses and contrasted with any other information on the hazardous product or the container.

7. If it is not possible to affix all appropriate labelling elements for each hazardous single component directly on the outer label (due to technical reasons) additional options, always carried out with maximum care and with regard to the nature of the set or kit, can be chosen.

### **Minimum information on the outer label:**

#### **Possibility 1:**

- (a) supplier information (see 1.4.10.5.2 (e))
- (b) product identifier (see 1.4.10.5.2 (d)ii)
- (c) pictograms of each hazardous single component, without duplication (see 1.4.10.5.3.1)
- (d) signal word (see 1.4.10.5.2 (a))
- (e) hazard statements of each hazardous single component (a clear allocation has to be ensured) (see 1.4.10.5.2(b))
- (f) supplemental information of each hazardous single component (a clear allocation has to be ensured) (see 1.4.10.5.4.2)
- (g) accumulated precautionary statements of each hazardous single component (see 1.4.10.5.2.(c))

#### **Possibility 2:**

- (a) supplier identification (see 1.4.10.5.2(e));
- (b) product identifier (see 1.4.10.5.2.(d)ii);
- (c) pictograms of each single hazardous component without duplication (see 1.4.10.5.3.1)
- (d) signal word (see 1.4.10.5.2(a));
- (e) full labelling information of each hazardous single component affixed in the inside of the combination package (see 1.4.10.5.2(a) - 1.4.10.5.2(d)ii)

## Minimum information on the inner label:

8. If single containers are designed to be taken out of the combination package, and there is no technical possibility to label them completely, then it is sufficient to use:

- (a) supplier information (see 1.4.10.5.2(e));
- (b) product identifier (see 1.4.10.5.2.(d)ii);
- (c) pictogram;
- (d) signal word (see 1.4.10.5.2(a));
- (e) “Read outer label”

9. A labelling of the single components can be omitted if it can be assured that they cannot be removed from the combination package.

## Example 1 based on possibility 1:

**Reagent-Kit for water analysis consisting of two different products in a small size outer package, which is used to store the immediate containers until ready for use.**

Packaging description and size:

Styrofoam box containing 15 glass ampoules, each ampoule filled with 3.5 ml of the same mixture (total volume: 52.5 ml), and two bottles filled with 5 ml of a mixture (total volume 10 ml).

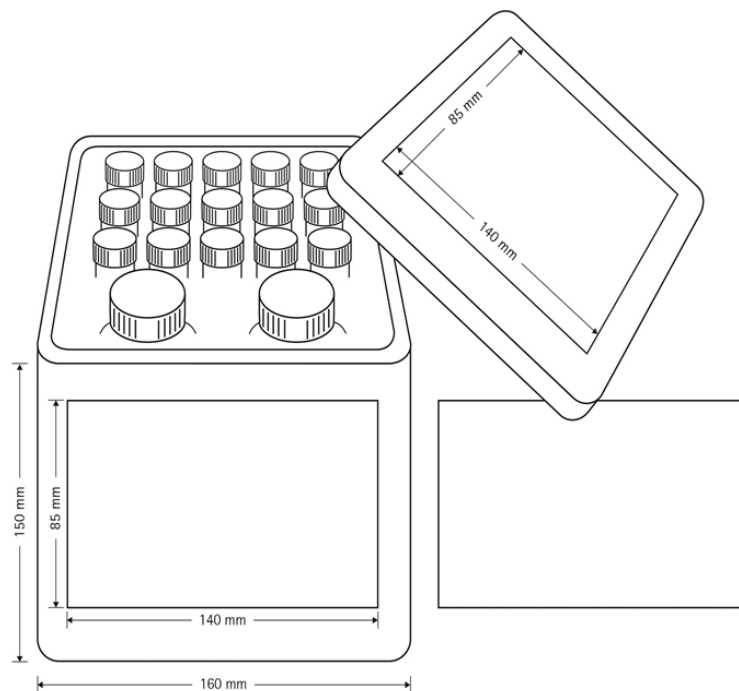

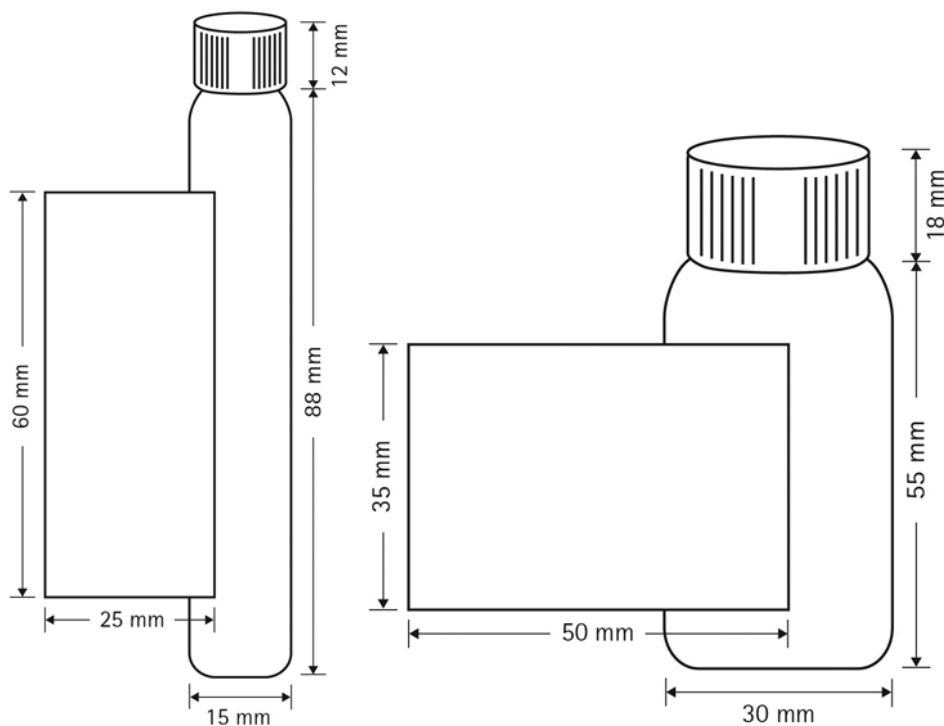

**Reagent 1: : (Glass ampoule)** Mixture containing ammonia solution and potassium cyanide

**Classification:** Acute toxicity cat.3 (dermal, inhalation)  
 Acute toxicity cat.4 (oral)  
 Skin corrosion cat. 1B  
 chronic aquatic hazard cat.3

**Labelling:**

**Pictogram:**



**Signal Word:**

Danger

**Hazard Statements:**

H311+H331: Toxic in contact with skin or if inhaled  
 H302: Harmful if swallowed  
 H412: Harmful to aquatic life with long lasting effects

**Precautionary Statements**

**Prevention:**

P264: Wash...thoroughly after handling  
 P270: Do not eat drink or smoke when using this product  
 P280: Wear protective gloves/protective clothing/eye protection/face protection  
 P260: Do not breath fume/vapour  
 P271: Use only outdoors or in a well ventilated area  
 P273: Avoid release to the environment

**Response:**

P390: Adsorb spillage to prevent material-damage  
 P321: Specific treatment (see ... on this label)  
 P330: Rinse mouth  
 P302+P352: IF ON SKIN: wash with plenty of water/...  
 P310: Immediately call a POISON CENTER/doctor/...  
 P311: Call a POISON CENTER/doctor/...  
 P312: Call a POISON CENTER/ doctor/... if you feel unwell  
 P301+P310: Get medical advice/attention if you feel unwell.  
 P314: Get medical advice/attention if you feel unwell  
 P361+P364: Take off immediately all contaminated clothing and wash it before reuse  
 P363: Wash contaminated clothing before reuse  
 P304+P340: IF INHALED: Remove person to fresh air and keep comfortable for breathing  
 P301+P330+P331: IF SWALLOWED: Rinse mouth. Do not induce vomiting  
 P303+P361+P353: IF ON SKIN (or hair): Take off immediately all contaminated clothing. Rinse skin with water/shower  
 P305+P351+P338: IF IN EYES: Rinse cautiously with water for several minutes. Remove contact lenses, if present and easy to do. Continue rinsing.

**Storage:**

P406: Store in a corrosive resistant container with a resistant inner liner  
 P405: Store locked up  
 P403+P233: Store in a well-ventilated place. Keep container tightly closed

**Diposal:**

P501: Dispose of contents/container to...

**Reagent 2: (Bottle) Mixture containing hydroxylammonium chloride**

**Classification:** Corrosive to metals cat.1  
 Skin irritation cat.2  
 Eye irritation cat.2  
 Skin sensitization cat.1  
 Carcinogenicity cat.2  
 STOT repeated cat.2

**Labelling:****Pictogram:****Signal word:**

Warning

**Hazard statements:**

H290: Maybe corrosive to metals  
 H315: Causes skin irritation  
 H319: causes serious eye irritation:  
 H317: May cause an allergic skin reaction  
 H351: Suspected of causing cancer  
 H373: May cause damage to organs through prolonged or repeated exposure

**Precautionary statements****Prevention:**

P201: Obtain special instructions before use

P202: Do not handle until all safety precautions have been read and understood.

P264: Wash...thoroughly after handling

P280: Wear protective gloves/protective clothing/eye protection/face protection

P260: Do not breathe fume/vapour

P272: Contaminated work clothing should not be allowed out of the workplace

**Response:**

P321: Specific treatment (see ... on this label)

P302+P352: IF ON SKIN: wash with plenty of water/...

P310: Immediately call a POISON CENTER/doctor/...

P314: Get medical advice/attention if you feel unwell

P308+P313: If exposed or concerned: Get medical advice/attention.

P337+P313: If eye irritation persists: Get medical advice attention

P332+P313: If skin irritation occurs: Get medical advice attention P362+P364: Take off contaminated clothing and wash it before reuse

P303+P361+P353: IF ON SKIN (or hair): Take off immediately all contaminated clothing. Rinse skin with water/shower

P305+P351+P338: IF IN EYES: Rinse cautiously with water for several minutes. Remove contact lenses, if present and easy to do. Continue rinsing.

**Storage:**

P405: Store locked up

**Disposal:**

P501: Dispose of contents/container to...

**Possible options to address labelling problems encountered**

Issue	Potential options	Comments
Divide the outer label in so many pieces to provide all label elements of each hazardous single component on the outer packaging/label		due to size and shape of the combination package it is not possible to divide the outer label in so many pieces as are necessary for enabling a labelling of each hazardous single component  (the main reason are 10-30 precautionary statements for each hazardous single component )
	Matched pictograms of each hazardous component, without duplication	A clear visual appearance is guaranteed
	Accumulate all appropriate precautionary statements of each hazardous single components	redundant information can be omitted, a better font size could be used

<b>Reagent 1 precautionary statements</b>	<b>Reagent 2 precautionary statements</b>	<b>Combined appropriate precautionary statements</b>
P201:Obtain special instructions before use	P264: Wash...thoroughly after handling	P201:Obtain special instructions before use
P202: Do not handle until all safety precau-tions have been read and understood	P270: Do not eat drink or smoke when using this product	P202: Do not handle until all safety precau-tions have been read and understood
P264: Wash...thoroughly after handling	P280: Wear protective gloves/protective clothing/eye protection/face protection	P264: Wash...thoroughly after handling
P280: Wear protective gloves/protective clothing/eye protection/face protection	P260: Do not breath fume/vapour	P308+P313: If exposed or concerned: Get medical advice/attention.
P260: Do not breath fume/vapour	P271: Use only outdoors or in a well ventilated area	P302+P352: IF ON SKIN: wash with plenty of water/...
P272: Contaminated work clothing should not be allowed out of the workplace	P273: Avoid release to the environment	P280: Wear protective gloves/protective clothing/eye protection/face protection
P390: Adsorb spillage to prevent material-	P321: Specific treatment (see ... on this label)	P302+P352: IF ON SKIN: wash with plenty of water/...
P321: Specific treatment (see ... on this label)		P301+P330+P331: IF SWALLOWED: Rinse mouth. Do not induce vomiting
P330: Rinse mouth		P310: Immediately call a POISON CENTER/doctor/...
P302+P352: IF ON SKIN: wash with plenty of water/...	P314: Get medical advice/attention if you feel unwell	P305+P351+P338: IF IN EYES: Rinse cautiously with water for several minutes. Remove contact lenses, if present and easy to do. Continue rinsing
P310: Immediately call a POISON CENTER/doctor/...	P308+P313: If exposed or concerned: Get medical advice/attention.	
P311: Call a POISON CENTER/doctor/...	P337+P313: If eye irritation persist: Get medical advice attention	
P312: Call a POISON CENTER/ doctor/... if you feel unwell	P332+P313: If skin irritation occurs: Get medical advice/attention	
	P362+P364: Take off contaminated clothing and wash it before reuse	
P301+P310: Get medical advice/attention if you feel unwell	P303+P361+P353: IF ON SKIN (or hair): Take off immediately all contaminated clothing. Rinse skin with water/shower	
P314: Get medical advice/attention if you feel unwell	P305+P351+P338: IF IN EYES: Rinse cautiously with water for several minutes. Remove contact lenses, if present and easy to do. Continue rinsing.	
P361+P364: Take off immediately all contaminated clothing and wash it before reuse	P302+P352: IF ON SKIN: wash with plenty of water/...	
P363: Wash contaminated clothing before reuse	P310: Immediately call a POISON CENTER/doctor/...	
P304+P340: IF INHALED: Remove person to fresh air and keep comfortable for breathing		
P301+P330+P331: IF SWALLOWED: Rinse mouth. Do not induce vomiting		
P303+P361+P353: IF ON SKIN (or hair): Take off immediately all contaminated clothing. Rinse skin with water/shower		
P305+P351+P338: IF IN EYES: Rinse cautiously with water for several minutes. Remove contact lenses, if present and easy to do. Continue rinsing		
P406: Store in a corrosive resistant container with a resistant inner liner	P405:Store locked up	
P405:Store locked up		
P403+P233:Store in a well ventilated place. Keep container tightly closed		
P501: Dispose of contents/container to...	P501: Dispose of contents/container to...	

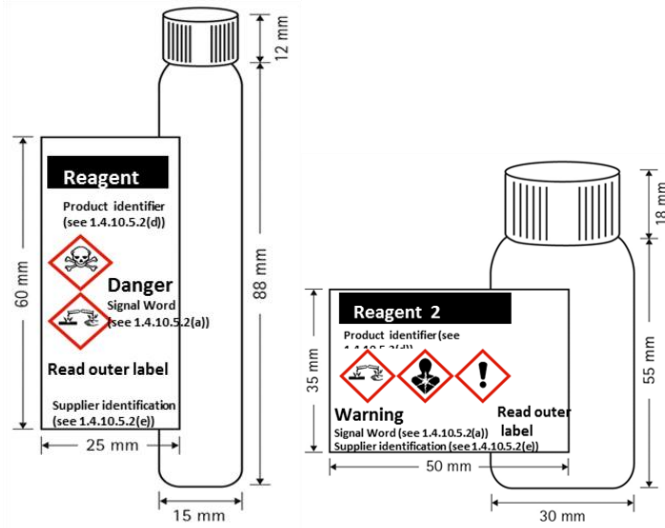



## Example 1 based on possibility 2:

The Sample Kit is used for marketing purposes and consists of 156 different products in individual 10 ml bottles presented in an outer package. The inner bottles are stored in the outer package throughout the lifecycle of the Sample Kit. Customers may select individual bottles and remove them from the box to check clarity, color or odor and then replace it into the open slot within the outer box.

### Packaging description and size:

Each sample test kit is constructed of a plastic outer box containing 156 bottle. Each bottle is filled with 10 ml of 156 different mixtures (total volume: 1560 ml). Depending upon the product mix, some or all of the 156 different materials may be considered hazardous.

### Possible options to address labelling problems encountered

Issue	Potential options	Comments
Kits contain many small inner packages containing many different hazardous products in one outer box/container.		Inner containers are too small to accommodate full GHS labels. There is limited space on the outer box to affix complete labels for each hazardous product due to size and shape of the combination package
	Provide label elements on a tie-on tag	Not practical as tie-on tag would need to be large to accommodate all required labelling even with printing on both sides of the tag. Large tag on a very small bottle may impede use of the product and users may remove tag in frustration..  General principles require all applicable label elements to appear on immediate container where possible; also some label elements on the immediate container may need to be accessible to users throughout life of product. Would therefore also need to include minimum label elements on immediate container just in case the tie-on tag is removed by the user.
	Increase the size of the container so that a larger label can be affixed	Not a practical solution. Increasing the size of the container is not practical from the intended use perspective.  Increasing the size of the container without increasing product volume may introduce oxygen into the contents of the container causing oxidation of the material which could change the aroma, flavour or potency.  Also need to take account of sustainability considerations (e.g. packaging reduction, environmental footprint, etc.)

Issue	Potential options	Comments
	Use already accepted limited information on inner packaging	5 label elements can be displayed in a font size to make highly visible and comprehensible hazard communication.
	Apply modified label format to outside of kit	Emphasizes most important label elements (identifier, manufacturer information, unique pictogram(s), signal word, hazard statement relative to each inner package.
	Display pictograms of each hazardous component, without duplication on outer label along with signal word	A clear visual appearance is guaranteed. In the case of breakage, not knowing which inners have broken, the user immediately is apprised of the hazards that are contained within.
	For a kit with many hazardous inners, the label space available may still not be adequate; allow the manufacturer to include slip sheets identifying each hazardous material and its full GHS labelling on the inside of the box.	This accommodation allows the user access to all GHS hazard communication label elements for each individual bottle containing a hazardous substance or mixture.

### Example 1 based on possibility 2

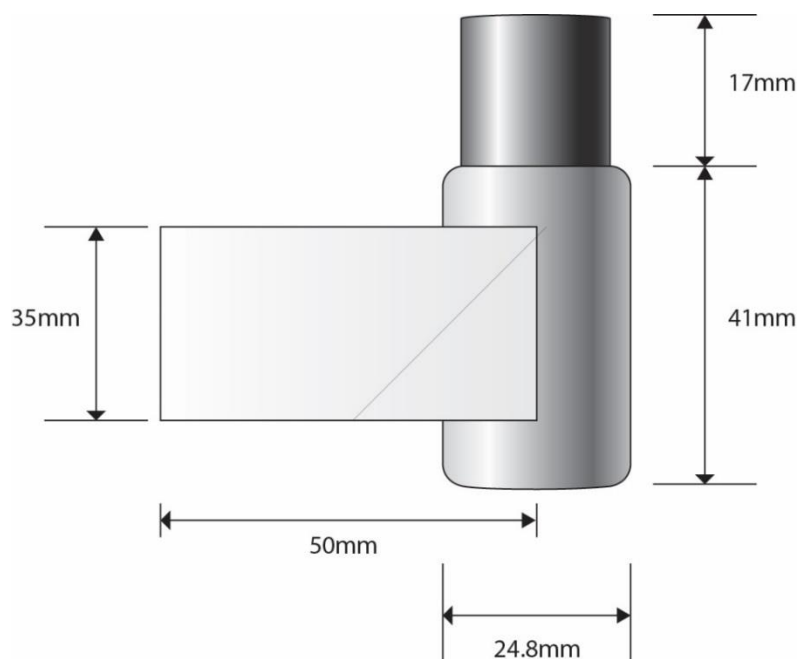

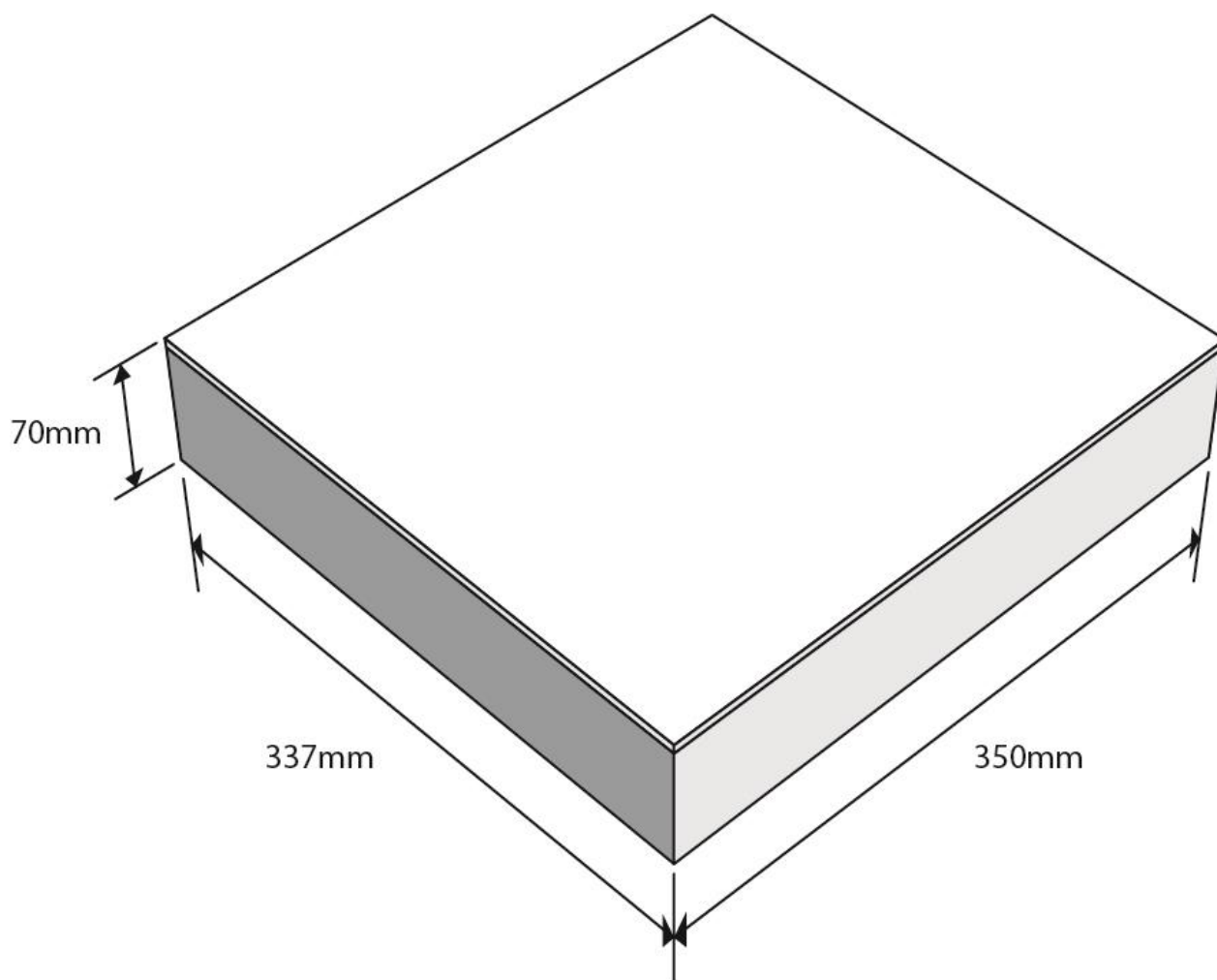
**Outer kit labelling:**





The outer box, given the limited area for labeling, will display;



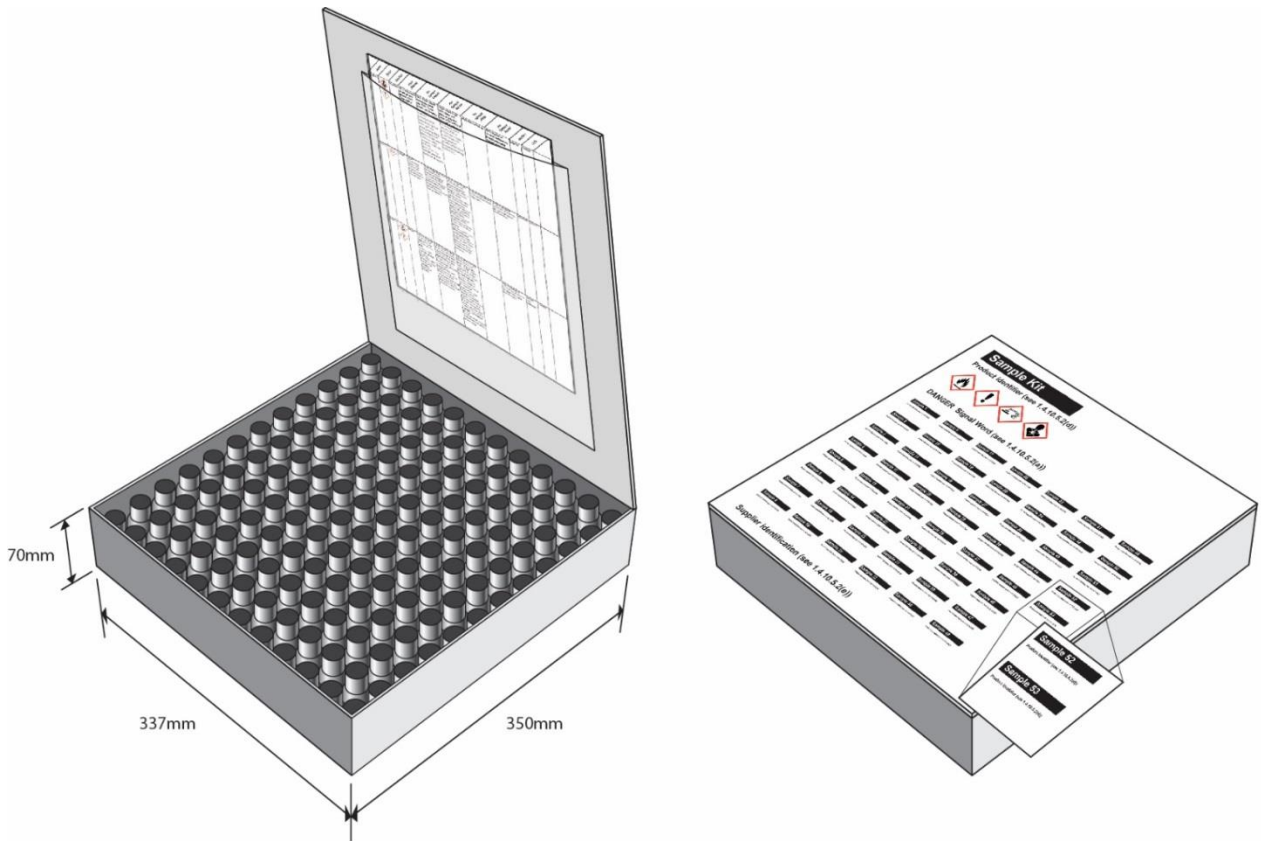
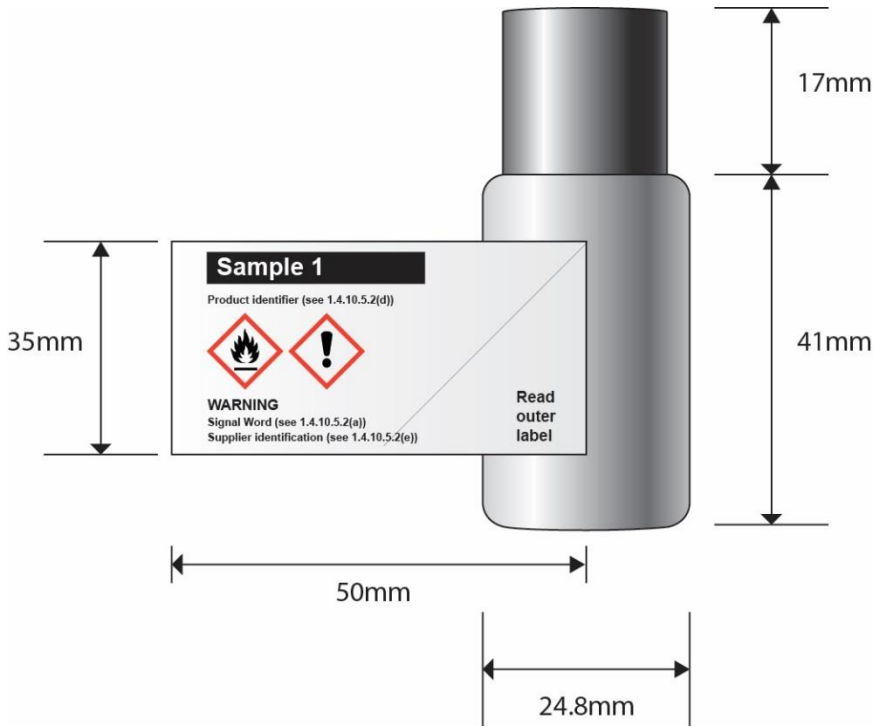

- (a) supplier identification (see 1.4.10.5.2(e))
- (b) product identifier (see 1.4.10.5.2.(d)ii)
- (c) pictograms of each single hazardous component without duplication (see 1.4.10.5.3.1)
- (d) signal word (see 1.4.10.5.2(a))



**Inside kit labelling:**





Full labelling information regarding each hazardous single component will be affixed in the inside of the combination package .





Identifier	Pictograms	Signal Word	Hazard Statements	Precautionary Statements			
				Prevention	Response	Storage	Disposal
Sample 1	 	Warning	H226: Flammable liquid and vapour.; H319: Causes serious eye irritation.	P210: Keep away from heat/sparks/open flames/hot surfaces. - No smoking.; P233: Keep container tightly closed.; P240: Ground/bond container and receiving equipment.; P241: Use explosion-proof electrical/ventilating/ lighting/ equipment.; P242: Use only non-sparking tools.; P243: Take precautionary measures against static discharge.; P264: Wash skin thoroughly after handling.; P280: Wear protective gloves/ eye protection/ face protection.	P303 + P361 + P353: IF ON SKIN (or hair): Remove/ Take off immediately all contaminated clothing. Rinse skin with water/ shower.; P305 + P351 + P338: IF IN EYES: Rinse cautiously with water for several minutes. Remove contact lenses, if present and easy to do. Continue rinsing.; P337 + P313: If eye irritation persists: Get medical advice/ attention.; P370 + P378: In case of fire: Use dry sand, dry chemical or alcohol-resistant foam for extinction.	P403 + P235: Store in a well-ventilated place. Keep cool.	P501: Dispose of contents/ container to an approved waste disposal plant.
Sample 2		Warning	H317: May cause an allergic skin reaction.	P261: Avoid breathing dust/ fume/ gas/ mist/ vapours/ spray.; P272: Contaminated work clothing should not be allowed out of the workplace.; P280: Wear protective gloves.	P302 + P352: IF ON SKIN: Wash with plenty of soap and water.; P333 + P313: If skin irritation or rash occurs: Get medical advice/ attention.; P363: Wash contaminated clothing before reuse.		P501: Dispose of contents/ container to an approved waste disposal plant.
Sample 3		Warning	H315: Causes skin irritation.; H319: Causes serious eye irritation.	P264: Wash skin thoroughly after handling.; P280: Wear eye protection/ face protection.; P280: Wear protective gloves.	P302 + P352: IF ON SKIN: Wash with plenty of soap and water.; P305 + P351 + P338: IF IN EYES: Rinse cautiously with water for several minutes. Remove contact lenses, if present and easy to do. Continue rinsing.; P332 + P313: If skin irritation occurs: Get medical advice/ attention.; P337 + P313: If eye irritation persists: Get medical advice/ attention.; P362: Take off contaminated clothing and wash before reuse.		







Identifier	Pictograms	Signal Word	Hazard Statements	Precautionary Statements			
				Prevention	Response	Storage	Disposal
Sample 4	 	Danger	H225: Highly flammable liquid and vapour.; H319: Causes serious eye irritation.	P210: Keep away from heat/sparks/open flames/hot surfaces. - No smoking.; P233: Keep container tightly closed.; P240: Ground/bond container and receiving equipment.; P241: Use explosion-proof electrical/ventilating/ lighting/ equipment.; P242: Use only non-sparking tools.; P243: Take precautionary measures against static discharge.; P264: Wash skin thoroughly after handling.; P280: Wear protective gloves/ eye protection/ face protection.	P303 + P361 + P353: IF ON SKIN (or hair): Remove/ Take off immediately all contaminated clothing. Rinse skin with water/ shower.; P305 + P351 + P338: IF IN EYES: Rinse cautiously with water for several minutes. Remove contact lenses, if present and easy to do. Continue rinsing.; P337 + P313: If eye irritation persists: Get medical advice/ attention.; P370 + P378: In case of fire: Use dry sand, dry chemical or alcohol-resistant foam for extinction.	P403 + P235: Store in a well-ventilated place. Keep cool.	P501: Dispose of contents/ container to an approved waste disposal plant.
Sample 5	 	Warning	H317: May cause an allergic skin reaction.; H351: Suspected of causing cancer.	P201: Obtain special instructions before use.; P202: Do not handle until all safety precautions have been read and understood.; P261: Avoid breathing dust/ fume/ gas/ mist/ vapours/ spray.; P272: Contaminated work clothing should not be allowed out of the workplace.; P280: Wear protective gloves.; P281: Use personal protective equipment as required.	P302 + P352: IF ON SKIN: Wash with plenty of soap and water.; P308 + P313: IF exposed or concerned: Get medical advice/ attention.; P333 + P313: If skin irritation or rash occurs: Get medical advice/ attention.; P363: Wash contaminated clothing before reuse.	P405: Store locked up.	P501: Dispose of contents/ container to an approved waste disposal plant.
Sample 6		Warning	H317: May cause an allergic skin reaction.	P261: Avoid breathing dust/ fume/ gas/ mist/ vapours/ spray.; P272: Contaminated work clothing should not be allowed out of the workplace.; P280: Wear protective gloves.	P302 + P352: IF ON SKIN: Wash with plenty of soap and water.; P333 + P313: If skin irritation or rash occurs: Get medical advice/ attention.; P363: Wash contaminated clothing before reuse.		P501: Dispose of contents/ container to an approved waste disposal plant.



Identifier	Pictograms	Signal Word	Hazard Statements	Precautionary Statements			
				Prevention	Response	Storage	Disposal
Sample 7		Warning	H351: Suspected of causing cancer.	P201: Obtain special instructions before use.; P202: Do not handle until all safety precautions have been read and understood.; P281: Use personal protective equipment as required.	P308 + P313: IF exposed or concerned: Get medical advice/ attention.	P405: Store locked up.	P501: Dispose of contents/ container to an approved waste disposal plant.
Sample 8		Warning	H227: Combustible liquid.	P210: Keep away from heat/sparks/open flames/hot surfaces. - No smoking.; P280: Wear protective gloves/ eye protection/ face protection.	P370 + P378: In case of fire: Use dry sand, dry chemical or alcohol-resistant foam for extinction.	P403 + P235: Store in a well-ventilated place. Keep cool.	P501: Dispose of contents/ container to an approved waste disposal plant.
Sample 9		Warning	H227: Combustible liquid.	P210: Keep away from heat/sparks/open flames/hot surfaces. - No smoking.; P280: Wear protective gloves/ eye protection/ face protection.	P370 + P378: In case of fire: Use dry sand, dry chemical or alcohol-resistant foam for extinction.	P403 + P235: Store in a well-ventilated place. Keep cool.	P501: Dispose of contents/ container to an approved waste disposal plant.
Sample 10		Danger	H227: Combustible liquid.; H315: Causes skin irritation.; H318: Causes serious eye damage.	P210: Keep away from heat/sparks/open flames/hot surfaces. - No smoking.; P264: Wash skin thoroughly after handling.; P280: Wear protective gloves/ eye protection/ face protection.	P302 + P352: IF ON SKIN: Wash with plenty of soap and water.; P305 + P351 + P338 + P310: IF IN EYES: Rinse cautiously with water for several minutes. Remove contact lenses, if present and easy to do. Continue rinsing. Immediately call a POISON CENTER or doctor/ physician.; P332 + P313: If skin irritation occurs: Get medical advice/ attention.; P362: Take off contaminated clothing and wash before reuse.; P370 + P378: In case of fire: Use dry sand, dry chemical or alcohol-resistant foam for extinction.	P403 + P235: Store in a well-ventilated place. Keep cool.	P501: Dispose of contents/ container to an approved waste disposal plant.



Identifier	Pictograms	Signal Word	Hazard Statements	Precautionary Statements			
				Prevention	Response	Storage	Disposal
Sample 11		Warning	H317: May cause an allergic skin reaction.	P261: Avoid breathing dust/ fume/ gas/ mist/ vapours/ spray.; P272: Contaminated work clothing should not be allowed out of the workplace.; P280: Wear protective gloves.	P302 + P352: IF ON SKIN: Wash with plenty of soap and water.; P333 + P313: If skin irritation or rash occurs: Get medical advice/ attention.; P363: Wash contaminated clothing before reuse.		P501: Dispose of contents/ container to an approved waste disposal plant.
Sample 12	 	Warning	H226: Flammable liquid and vapour.; H317: May cause an allergic skin reaction.	P210: Keep away from heat/sparks/open flames/hot surfaces. - No smoking.; P233: Keep container tightly closed.; P240: Ground/bond container and receiving equipment.; P241: Use explosion-proof electrical/ ventilating/ lighting/ equipment.; P242: Use only non-sparking tools.; P243: Take precautionary measures against static discharge.; P261: Avoid breathing dust/ fume/ gas/ mist/ vapours/ spray.; P272: Contaminated work clothing should not be allowed out of the workplace.; P280: Wear protective gloves/ eye protection/ face protection.	P303 + P361 + P353: IF ON SKIN (or hair): Remove/ Take off immediately all contaminated clothing. Rinse skin with water/ shower.; P333 + P313: If skin irritation or rash occurs: Get medical advice/ attention.; P363: Wash contaminated clothing before reuse.; P370 + P378: In case of fire: Use dry sand, dry chemical or alcohol-resistant foam for extinction.	P403 + P235: Store in a well-ventilated place. Keep cool.	P501: Dispose of contents/ container to an approved waste disposal plant.
Sample 13		Warning	H317: May cause an allergic skin reaction.	P261: Avoid breathing dust/ fume/ gas/ mist/ vapours/ spray.; P272: Contaminated work clothing should not be allowed out of the workplace.; P280: Wear protective gloves.	P302 + P352: IF ON SKIN: Wash with plenty of soap and water.; P333 + P313: If skin irritation or rash occurs: Get medical advice/ attention.; P363: Wash contaminated clothing before reuse.		P501: Dispose of contents/ container to an approved waste disposal plant.







Identifier	Pictograms	Signal Word	Hazard Statements	Precautionary Statements			
				Prevention	Response	Storage	Disposal
Sample 14		Danger	H317: May cause an allergic skin reaction.; H319: Causes serious eye irritation.; H372: Causes damage to organs through prolonged or repeated exposure if inhaled.	P260: Do not breathe dust/ fume/ gas/ mist/ vapours/ spray.; P264: Wash skin thoroughly after handling.; P270: Do not eat, drink or smoke when using this product.; P272: Contaminated work clothing should not be allowed out of the workplace.; P280: Wear eye protection/ face protection.; P280: Wear protective gloves.	P302 + P352: IF ON SKIN: Wash with plenty of soap and water.; P305 + P351 + P338: IF IN EYES: Rinse cautiously with water for several minutes. Remove contact lenses, if present and easy to do. Continue rinsing.; P314: Get medical advice/ attention if you feel unwell.; P333 + P313: If skin irritation or rash occurs: Get medical advice/ attention.; P337 + P313: If eye irritation persists: Get medical advice/ attention.; P363: Wash contaminated clothing before reuse.		P501: Dispose of contents/ container to an approved waste disposal plant.
Sample 15		Warning	H315: Causes skin irritation.; H319: Causes serious eye irritation.	P264: Wash skin thoroughly after handling.; P280: Wear eye protection/ face protection.; P280: Wear protective gloves.	P302 + P352: IF ON SKIN: Wash with plenty of soap and water.; P305 + P351 + P338: IF IN EYES: Rinse cautiously with water for several minutes. Remove contact lenses, if present and easy to do. Continue rinsing.; P332 + P313: If skin irritation occurs: Get medical advice/ attention.; P337 + P313: If eye irritation persists: Get medical advice/ attention.; P362: Take off contaminated clothing and wash before reuse.		



Identifier	Pictograms	Signal Word	Hazard Statements	Precautionary Statements			
				Prevention	Response	Storage	Disposal
Sample 16	  	Danger	H226: Flammable liquid and vapour.; H304: May be fatal if swallowed and enters airways.; H315: Causes skin irritation.; H317: May cause an allergic skin reaction.	P210: Keep away from heat/sparks/open flames/hot surfaces. - No smoking.; P233: Keep container tightly closed.; P240: Ground/bond container and receiving equipment.; P241: Use explosion-proof electrical/ventilating/ lighting/ equipment.; P242: Use only non-sparking tools.; P243: Take precautionary measures against static discharge.; P261: Avoid breathing dust/ fume/ gas/ mist/ vapours/ spray.; P264: Wash skin thoroughly after handling.; P272: Contaminated work clothing should not be allowed out of the workplace.; P280: Wear protective gloves/ eye protection/ face protection.	P301 + P310: IF SWALLOWED: Immediately call a POISON CENTER or doctor/ physician.; P303 + P361 + P353: IF ON SKIN (or hair): Remove/ Take off immediately all contaminated clothing. Rinse skin with water/ shower.; P331: Do NOT induce vomiting.; P333 + P313: If skin irritation or rash occurs: Get medical advice/ attention.; P362: Take off contaminated clothing and wash before reuse.; P370 + P378: In case of fire: Use dry sand, dry chemical or alcohol-resistant foam for extinction.	P403 + P235: Store in a well-ventilated place. Keep cool.; P405: Store locked up.	P501: Dispose of contents/ container to an approved waste disposal plant.
Sample 17	 	Warning	H317: May cause an allergic skin reaction.; H351: Suspected of causing cancer.	P201: Obtain special instructions before use.; P202: Do not handle until all safety precautions have been read and understood.; P261: Avoid breathing dust/ fume/ gas/ mist/ vapours/ spray.; P272: Contaminated work clothing should not be allowed out of the workplace.; P280: Wear protective gloves.; P281: Use personal protective equipment as required.	P302 + P352: IF ON SKIN: Wash with plenty of soap and water.; P308 + P313: IF exposed or concerned: Get medical advice/ attention.; P333 + P313: If skin irritation or rash occurs: Get medical advice/ attention.; P363: Wash contaminated clothing before reuse.	P405: Store locked up.	P501: Dispose of contents/ container to an approved waste disposal plant.
Sample 18		Warning	H317: May cause an allergic skin reaction.	P261: Avoid breathing dust/ fume/ gas/ mist/ vapours/ spray.; P272: Contaminated work clothing should not be allowed out of the workplace.; P280: Wear protective gloves.	P302 + P352: IF ON SKIN: Wash with plenty of soap and water.; P333 + P313: If skin irritation or rash occurs: Get medical advice/ attention.; P363: Wash contaminated clothing before reuse.		P501: Dispose of contents/ container to an approved waste disposal plant.





Identifier	Pictograms	Signal Word	Hazard Statements	Precautionary Statements			
				Prevention	Response	Storage	Disposal
Sample 19		Warning	H227: Combustible liquid.; H319: Causes serious eye irritation.	P210: Keep away from heat/sparks/open flames/hot surfaces. - No smoking.; P264: Wash skin thoroughly after handling.; P280: Wear protective gloves/ eye protection/ face protection.	P305 + P351 + P338: IF IN EYES: Rinse cautiously with water for several minutes. Remove contact lenses, if present and easy to do. Continue rinsing.; P337 + P313: If eye irritation persists: Get medical advice/ attention.; P370 + P378: In case of fire: Use dry sand, dry chemical or alcohol-resistant foam for extinction.	P403 + P235: Store in a well-ventilated place. Keep cool.	P501: Dispose of contents/ container to an approved waste disposal plant.
Sample 20		Warning	H227: Combustible liquid.	P210: Keep away from heat/sparks/open flames/hot surfaces. - No smoking.; P280: Wear protective gloves/ eye protection/ face protection.	P370 + P378: In case of fire: Use dry sand, dry chemical or alcohol-resistant foam for extinction.	P403 + P235: Store in a well-ventilated place. Keep cool.	P501: Dispose of contents/ container to an approved waste disposal plant.
Sample 21		Warning	H227: Combustible liquid.	P210: Keep away from heat/sparks/open flames/hot surfaces. - No smoking.; P280: Wear protective gloves/ eye protection/ face protection.	P370 + P378: In case of fire: Use dry sand, dry chemical or alcohol-resistant foam for extinction.	P403 + P235: Store in a well-ventilated place. Keep cool.	P501: Dispose of contents/ container to an approved waste disposal plant.
Sample 22		Warning	H227: Combustible liquid.; H315: Causes skin irritation.; H319: Causes serious eye irritation.	P210: Keep away from heat/sparks/open flames/hot surfaces. - No smoking.; P264: Wash skin thoroughly after handling.; P280: Wear protective gloves/ eye protection/ face protection.	P302 + P352: IF ON SKIN: Wash with plenty of soap and water.; P305 + P351 + P338: IF IN EYES: Rinse cautiously with water for several minutes. Remove contact lenses, if present and easy to do. Continue rinsing.; P332 + P313: If skin irritation occurs: Get medical advice/ attention.; P337 + P313: If eye irritation persists: Get medical advice/ attention.; P362: Take off contaminated clothing and wash before reuse.; P370 + P378: In case of fire: Use dry sand, dry chemical or alcohol-resistant foam for extinction.	P403 + P235: Store in a well-ventilated place. Keep cool.	P501: Dispose of contents/ container to an approved waste disposal plant.

Identifier	Pictograms	Signal Word	Hazard Statements	Precautionary Statements			
				Prevention	Response	Storage	Disposal
Sample 23		Danger	H225: Highly flammable liquid and vapour.; H319: Causes serious eye irritation.	P210: Keep away from heat/sparks/open flames/hot surfaces. - No smoking.; P233: Keep container tightly closed.; P240: Ground/bond container and receiving equipment.; P241: Use explosion-proof electrical/ventilating/ lighting/ equipment.; P242: Use only non-sparking tools.; P243: Take precautionary measures against static discharge.; P264: Wash skin thoroughly after handling.; P280: Wear protective gloves/ eye protection/ face protection.	P303 + P361 + P353: IF ON SKIN (or hair): Remove/ Take off immediately all contaminated clothing. Rinse skin with water/ shower.; P305 + P351 + P338: IF IN EYES: Rinse cautiously with water for several minutes. Remove contact lenses, if present and easy to do. Continue rinsing.; P337 + P313: If eye irritation persists: Get medical advice/ attention.; P370 + P378: In case of fire: Use dry sand, dry chemical or alcohol-resistant foam for extinction.	P403 + P235: Store in a well-ventilated place. Keep cool.	P501: Dispose of contents/ container to an approved waste disposal plant.
Sample 24		Warning	H317: May cause an allergic skin reaction.	P261: Avoid breathing dust/ fume/ gas/ mist/ vapours/ spray.; P272: Contaminated work clothing should not be allowed out of the workplace.; P280: Wear protective gloves.	P302 + P352: IF ON SKIN: Wash with plenty of soap and water.; P333 + P313: If skin irritation or rash occurs: Get medical advice/ attention.; P363: Wash contaminated clothing before reuse.		P501: Dispose of contents/ container to an approved waste disposal plant.
Sample 25		Warning	H315: Causes skin irritation.; H317: May cause an allergic skin reaction.; H319: Causes serious eye irritation.	P261: Avoid breathing dust/ fume/ gas/ mist/ vapours/ spray.; P264: Wash skin thoroughly after handling.; P272: Contaminated work clothing should not be allowed out of the workplace.; P280: Wear eye protection/ face protection.; P280: Wear protective gloves.	P302 + P352: IF ON SKIN: Wash with plenty of soap and water.; P305 + P351 + P338: IF IN EYES: Rinse cautiously with water for several minutes. Remove contact lenses, if present and easy to do. Continue rinsing.; P333 + P313: If skin irritation or rash occurs: Get medical advice/ attention.; P337 + P313: If eye irritation persists: Get medical advice/ attention.; P362: Take off contaminated clothing and wash before reuse.		P501: Dispose of contents/ container to an approved waste disposal plant.



Identifier	Pictograms	Signal Word	Hazard Statements	Precautionary Statements			
				Prevention	Response	Storage	Disposal
Sample 26		Warning	H317: May cause an allergic skin reaction.	P261: Avoid breathing dust/ fume/ gas/ mist/ vapours/ spray.; P272: Contaminated work clothing should not be allowed out of the workplace.; P280: Wear protective gloves.	P302 + P352: IF ON SKIN: Wash with plenty of soap and water.; P333 + P313: If skin irritation or rash occurs: Get medical advice/ attention.; P363: Wash contaminated clothing before reuse.		P501: Dispose of contents/ container to an approved waste disposal plant.
Sample 27		Warning	H226: Flammable liquid and vapour.; H319: Causes serious eye irritation.	P210: Keep away from heat/sparks/open flames/hot surfaces. - No smoking.; P233: Keep container tightly closed.; P240: Ground/bond container and receiving equipment.; P241: Use explosion-proof electrical/ ventilating/ lighting/ equipment.; P242: Use only non-sparking tools.; P243: Take precautionary measures against static discharge.; P264: Wash skin thoroughly after handling.; P280: Wear protective gloves/ eye protection/ face protection.	P303 + P361 + P353: IF ON SKIN (or hair): Remove/ Take off immediately all contaminated clothing. Rinse skin with water/ shower.; P305 + P351 + P338: IF IN EYES: Rinse cautiously with water for several minutes. Remove contact lenses, if present and easy to do. Continue rinsing.; P337 + P313: If eye irritation persists: Get medical advice/ attention.; P370 + P378: In case of fire: Use dry sand, dry chemical or alcohol-resistant foam for extinction.	P403 + P235: Store in a well-ventilated place. Keep cool.	P501: Dispose of contents/ container to an approved waste disposal plant.
Sample 28		Danger	H225: Highly flammable liquid and vapour.; H319: Causes serious eye irritation.	P210: Keep away from heat/sparks/open flames/hot surfaces. - No smoking.; P233: Keep container tightly closed.; P240: Ground/bond container and receiving equipment.; P241: Use explosion-proof electrical/ ventilating/ lighting/ equipment.; P242: Use only non-sparking tools.; P243: Take precautionary measures against static discharge.; P264: Wash skin thoroughly after handling.; P280: Wear protective gloves/ eye protection/ face protection.	P303 + P361 + P353: IF ON SKIN (or hair): Remove/ Take off immediately all contaminated clothing. Rinse skin with water/ shower.; P305 + P351 + P338: IF IN EYES: Rinse cautiously with water for several minutes. Remove contact lenses, if present and easy to do. Continue rinsing.; P337 + P313: If eye irritation persists: Get medical advice/ attention.; P370 + P378: In case of fire: Use dry sand, dry chemical or alcohol-resistant foam for extinction.	P403 + P235: Store in a well-ventilated place. Keep cool.	P501: Dispose of contents/ container to an approved waste disposal plant.





Identifier	Pictograms	Signal Word	Hazard Statements	Precautionary Statements			
				Prevention	Response	Storage	Disposal
Sample 29		Danger	H225: Highly flammable liquid and vapour.; H319: Causes serious eye irritation.	P210: Keep away from heat/sparks/open flames/hot surfaces. - No smoking.; P233: Keep container tightly closed.; P240: Ground/bond container and receiving equipment.; P241: Use explosion-proof electrical/ventilating/ lighting/ equipment.; P242: Use only non-sparking tools.; P243: Take precautionary measures against static discharge.; P264: Wash skin thoroughly after handling.; P280: Wear protective gloves/ eye protection/ face protection.	P303 + P361 + P353: IF ON SKIN (or hair): Remove/ Take off immediately all contaminated clothing. Rinse skin with water/shower.; P305 + P351 + P338: IF IN EYES: Rinse cautiously with water for several minutes. Remove contact lenses, if present and easy to do. Continue rinsing.; P337 + P313: If eye irritation persists: Get medical advice/ attention.; P370 + P378: In case of fire: Use dry sand, dry chemical or alcohol-resistant foam for extinction.	P403 + P235: Store in a well-ventilated place. Keep cool.	P501: Dispose of contents/ container to an approved waste disposal plant.
Sample 30		Warning	H351: Suspected of causing cancer.	P201: Obtain special instructions before use.; P202: Do not handle until all safety precautions have been read and understood.; P281: Use personal protective equipment as required.	P308 + P313: IF exposed or concerned: Get medical advice/ attention.	P405: Store locked up.	P501: Dispose of contents/ container to an approved waste disposal plant.
Sample 31		Warning	H227: Combustible liquid.	P210: Keep away from heat/sparks/open flames/hot surfaces. - No smoking.; P280: Wear protective gloves/ eye protection/ face protection.	P370 + P378: In case of fire: Use dry sand, dry chemical or alcohol-resistant foam for extinction.	P403 + P235: Store in a well-ventilated place. Keep cool.	P501: Dispose of contents/ container to an approved waste disposal plant.





Identifier	Pictograms	Signal Word	Hazard Statements	Precautionary Statements			
				Prevention	Response	Storage	Disposal
Sample 32		Warning	H315: Causes skin irritation.; H319: Causes serious eye irritation.	P264: Wash skin thoroughly after handling.; P280: Wear eye protection/ face protection.; P280: Wear protective gloves.	P302 + P352: IF ON SKIN: Wash with plenty of soap and water.; P305 + P351 + P338: IF IN EYES: Rinse cautiously with water for several minutes. Remove contact lenses, if present and easy to do. Continue rinsing.; P332 + P313: If skin irritation occurs: Get medical advice/ attention.; P337 + P313: If eye irritation persists: Get medical advice/ attention.; P362: Take off contaminated clothing and wash before reuse.		
Sample 33		Danger	H225: Highly flammable liquid and vapour.; H319: Causes serious eye irritation.	P210: Keep away from heat/sparks/open flames/hot surfaces. - No smoking.; P233: Keep container tightly closed.; P240: Ground/bond container and receiving equipment.; P241: Use explosion-proof electrical/ ventilating/ lighting/ equipment.; P242: Use only non-sparking tools.; P243: Take precautionary measures against static discharge.; P264: Wash skin thoroughly after handling.; P280: Wear protective gloves/ eye protection/ face protection.	P303 + P361 + P353: IF ON SKIN (or hair): Remove/ Take off immediately all contaminated clothing. Rinse skin with water/ shower.; P305 + P351 + P338: IF IN EYES: Rinse cautiously with water for several minutes. Remove contact lenses, if present and easy to do. Continue rinsing.; P337 + P313: If eye irritation persists: Get medical advice/ attention.; P370 + P378: In case of fire: Use dry sand, dry chemical or alcohol-resistant foam for extinction.	P403 + P235: Store in a well-ventilated place. Keep cool.	P501: Dispose of contents/ container to an approved waste disposal plant.

Identifier	Pictograms	Signal Word	Hazard Statements	Precautionary Statements			
				Prevention	Response	Storage	Disposal
Sample 34	 	Danger	H225: Highly flammable liquid and vapour.; H319: Causes serious eye irritation.	P210: Keep away from heat/sparks/open flames/hot surfaces. - No smoking.; P233: Keep container tightly closed.; P240: Ground/bond container and receiving equipment.; P241: Use explosion-proof electrical/ventilating/ lighting/ equipment.; P242: Use only non-sparking tools.; P243: Take precautionary measures against static discharge.; P264: Wash skin thoroughly after handling.; P280: Wear protective gloves/ eye protection/ face protection.	P303 + P361 + P353: IF ON SKIN (or hair): Remove/ Take off immediately all contaminated clothing. Rinse skin with water/ shower.; P305 + P351 + P338: IF IN EYES: Rinse cautiously with water for several minutes. Remove contact lenses, if present and easy to do. Continue rinsing.; P337 + P313: If eye irritation persists: Get medical advice/ attention.; P370 + P378: In case of fire: Use dry sand, dry chemical or alcohol-resistant foam for extinction.	P403 + P235: Store in a well-ventilated place. Keep cool.	P501: Dispose of contents/ container to an approved waste disposal plant.
Sample 35	 	Danger	H225: Highly flammable liquid and vapour.; H319: Causes serious eye irritation.	P210: Keep away from heat/sparks/open flames/hot surfaces. - No smoking.; P233: Keep container tightly closed.; P240: Ground/bond container and receiving equipment.; P241: Use explosion-proof electrical/ventilating/ lighting/ equipment.; P242: Use only non-sparking tools.; P243: Take precautionary measures against static discharge.; P264: Wash skin thoroughly after handling.; P280: Wear protective gloves/ eye protection/ face protection.	P303 + P361 + P353: IF ON SKIN (or hair): Remove/ Take off immediately all contaminated clothing. Rinse skin with water/ shower.; P305 + P351 + P338: IF IN EYES: Rinse cautiously with water for several minutes. Remove contact lenses, if present and easy to do. Continue rinsing.; P337 + P313: If eye irritation persists: Get medical advice/ attention.; P370 + P378: In case of fire: Use dry sand, dry chemical or alcohol-resistant foam for extinction.	P403 + P235: Store in a well-ventilated place. Keep cool.	P501: Dispose of contents/ container to an approved waste disposal plant.



Identifier	Pictograms	Signal Word	Hazard Statements	Precautionary Statements			
				Prevention	Response	Storage	Disposal
Sample 36		Danger	H314: Causes severe skin burns and eye damage.	P264: Wash skin thoroughly after handling.; P280: Wear protective gloves/ protective clothing/ eye protection/ face protection.	P301 + P330 + P331: IF SWALLOWED: Rinse mouth. Do NOT induce vomiting.; P303 + P361 + P353: IF ON SKIN (or hair): Remove/ Take off immediately all contaminated clothing. Rinse skin with water/ shower.; P304 + P340 + P310: IF INHALED: Remove victim to fresh air and keep at rest in a position comfortable for breathing. Immediately call a POISON CENTER or doctor/ physician.; P305 + P351 + P338 + P310: IF IN EYES: Rinse cautiously with water for several minutes. Remove contact lenses, if present and easy to do. Continue rinsing. Immediately call a POISON CENTER or doctor/ physician.; P363: Wash contaminated clothing before reuse.	P405: Store locked up.	P501: Dispose of contents/ container to an approved waste disposal plant.
Sample 37		Danger	H225: Highly flammable liquid and vapour.; H319: Causes serious eye irritation.	P210: Keep away from heat/sparks/open flames/hot surfaces. - No smoking.; P233: Keep container tightly closed.; P240: Ground/bond container and receiving equipment.; P241: Use explosion-proof electrical/ ventilating/ lighting/ equipment.; P242: Use only non-sparking tools.; P243: Take precautionary measures against static discharge.; P264: Wash skin thoroughly after handling.; P280: Wear protective gloves/ eye protection/ face protection.	P303 + P361 + P353: IF ON SKIN (or hair): Remove/ Take off immediately all contaminated clothing. Rinse skin with water/ shower.; P305 + P351 + P338: IF IN EYES: Rinse cautiously with water for several minutes. Remove contact lenses, if present and easy to do. Continue rinsing.; P337 + P313: If eye irritation persists: Get medical advice/ attention.; P370 + P378: In case of fire: Use dry sand, dry chemical or alcohol-resistant foam for extinction.	P403 + P235: Store in a well-ventilated place. Keep cool.	P501: Dispose of contents/ container to an approved waste disposal plant.

Identifier	Pictograms	Signal Word	Hazard Statements	Precautionary Statements			
				Prevention	Response	Storage	Disposal
Sample 38		Warning	H227: Combustible liquid.	P210: Keep away from heat/sparks/open flames/hot surfaces. - No smoking.; P280: Wear protective gloves/ eye protection/ face protection.	P370 + P378: In case of fire: Use dry sand, dry chemical or alcohol-resistant foam for extinction.	P403 + P235: Store in a well-ventilated place. Keep cool.	P501: Dispose of contents/ container to an approved waste disposal plant.
Sample 39		Danger	H318: Causes serious eye damage.	P280: Wear eye protection/ face protection.	P305 + P351 + P338 + P310: IF IN EYES: Rinse cautiously with water for several minutes. Remove contact lenses, if present and easy to do. Continue rinsing. Immediately call a POISON CENTER or doctor/ physician.		
Sample 40		Warning	H227: Combustible liquid.	P210: Keep away from heat/sparks/open flames/hot surfaces. - No smoking.; P280: Wear protective gloves/ eye protection/ face protection.	P370 + P378: In case of fire: Use dry sand, dry chemical or alcohol-resistant foam for extinction.	P403 + P235: Store in a well-ventilated place. Keep cool.	P501: Dispose of contents/ container to an approved waste disposal plant.
Sample 41		Warning	H317: May cause an allergic skin reaction.	P261: Avoid breathing dust/ fume/ gas/ mist/ vapours/ spray.; P272: Contaminated work clothing should not be allowed out of the workplace.; P280: Wear protective gloves.	P302 + P352: IF ON SKIN: Wash with plenty of soap and water.; P333 + P313: If skin irritation or rash occurs: Get medical advice/ attention.; P363: Wash contaminated clothing before reuse.		P501: Dispose of contents/ container to an approved waste disposal plant.
Sample 42		Warning	H351: Suspected of causing cancer.	P201: Obtain special instructions before use.; P202: Do not handle until all safety precautions have been read and understood.; P281: Use personal protective equipment as required.	P308 + P313: IF exposed or concerned: Get medical advice/ attention.	P405: Store locked up.	P501: Dispose of contents/ container to an approved waste disposal plant.
Sample 43		Warning	H351: Suspected of causing cancer.	P201: Obtain special instructions before use.; P202: Do not handle until all safety precautions have been read and understood.; P281: Use personal protective equipment as required.	P308 + P313: IF exposed or concerned: Get medical advice/ attention.	P405: Store locked up.	P501: Dispose of contents/ container to an approved waste disposal plant.

Identifier	Pictograms	Signal Word	Hazard Statements	Precautionary Statements			
				Prevention	Response	Storage	Disposal
Sample 44		Warning	H317: May cause an allergic skin reaction.	P261: Avoid breathing dust/ fume/ gas/ mist/ vapours/ spray.; P272: Contaminated work clothing should not be allowed out of the workplace.; P280: Wear protective gloves.	P302 + P352: IF ON SKIN: Wash with plenty of soap and water.; P333 + P313: If skin irritation or rash occurs: Get medical advice/ attention.; P363: Wash contaminated clothing before reuse.		P501: Dispose of contents/ container to an approved waste disposal plant.
Sample 45		Warning	H317: May cause an allergic skin reaction.	P261: Avoid breathing dust/ fume/ gas/ mist/ vapours/ spray.; P272: Contaminated work clothing should not be allowed out of the workplace.; P280: Wear protective gloves.	P302 + P352: IF ON SKIN: Wash with plenty of soap and water.; P333 + P313: If skin irritation or rash occurs: Get medical advice/ attention.; P363: Wash contaminated clothing before reuse.		P501: Dispose of contents/ container to an approved waste disposal plant.
Sample 46		Warning	H317: May cause an allergic skin reaction.	P261: Avoid breathing dust/ fume/ gas/ mist/ vapours/ spray.; P272: Contaminated work clothing should not be allowed out of the workplace.; P280: Wear protective gloves.	P302 + P352: IF ON SKIN: Wash with plenty of soap and water.; P333 + P313: If skin irritation or rash occurs: Get medical advice/ attention.; P363: Wash contaminated clothing before reuse.		P501: Dispose of contents/ container to an approved waste disposal plant.
Sample 47		Warning	H317: May cause an allergic skin reaction.	P261: Avoid breathing dust/ fume/ gas/ mist/ vapours/ spray.; P272: Contaminated work clothing should not be allowed out of the workplace.; P280: Wear protective gloves.	P302 + P352: IF ON SKIN: Wash with plenty of soap and water.; P333 + P313: If skin irritation or rash occurs: Get medical advice/ attention.; P363: Wash contaminated clothing before reuse.		P501: Dispose of contents/ container to an approved waste disposal plant.

Identifier	Pictograms	Signal Word	Hazard Statements	Precautionary Statements			
				Prevention	Response	Storage	Disposal
Sample 48		Danger	<p>H226: Flammable liquid and vapour.;</p> <p>H304: May be fatal if swallowed and enters airways.;</p> <p>H315: Causes skin irritation.;</p> <p>H317: May cause an allergic skin reaction.</p>	<p>P210: Keep away from heat/sparks/open flames/hot surfaces. - No smoking.;</p> <p>P233: Keep container tightly closed.;</p> <p>P240: Ground/bond container and receiving equipment.;</p> <p>P241: Use explosion-proof electrical/ventilating/ lighting/ equipment.;</p> <p>P242: Use only non-sparking tools.;</p> <p>P243: Take precautionary measures against static discharge.;</p> <p>P261: Avoid breathing dust/ fume/ gas/ mist/ vapours/ spray.;</p> <p>P264: Wash skin thoroughly after handling.;</p> <p>P272: Contaminated work clothing should not be allowed out of the workplace.;</p> <p>P280: Wear protective gloves/ eye protection/ face protection.</p>	<p>P301 + P310: IF SWALLOWED: Immediately call a POISON CENTER or doctor/ physician.;</p> <p>P303 + P361 + P353: IF ON SKIN (or hair): Remove/ Take off immediately all contaminated clothing. Rinse skin with water/ shower.;</p> <p>P331: Do NOT induce vomiting.;</p> <p>P333 + P313: If skin irritation or rash occurs: Get medical advice/ attention.;</p> <p>P362: Take off contaminated clothing and wash before reuse.;</p> <p>P370 + P378: In case of fire: Use dry sand, dry chemical or alcohol-resistant foam for extinction.</p>	<p>P403 + P235: Store in a well-ventilated place. Keep cool.;</p> <p>P405: Store locked up.</p>	<p>P501: Dispose of contents/ container to an approved waste disposal plant.</p>
Sample 49		Warning	<p>H227: Combustible liquid.</p>	<p>P210: Keep away from heat/sparks/open flames/hot surfaces. - No smoking.;</p> <p>P280: Wear protective gloves/ eye protection/ face protection.</p>	<p>P370 + P378: In case of fire: Use dry sand, dry chemical or alcohol-resistant foam for extinction.</p>	<p>P403 + P235: Store in a well-ventilated place. Keep cool.</p>	<p>P501: Dispose of contents/ container to an approved waste disposal plant.</p>

