

**Draft amendment [2],
as updated in the informal working group meeting
of 16 – 17 December 2013**

Submitted by the informal working group on global technical regulation No. 9

The text reproduced below is presented by the pedestrian safety experts of the IWG on gtr No. 9 – Phase 2. It represents the outcome of discussion in their 9th meeting, held on 16 – 17 December 2013 in Geneva. The modifications to the text of the global technical regulation are marked in bold for new or strikethrough for deleted characters, tracked changes represent the changes to document UNECE/TRANS/WP.29/GRSP/2013/25.

I. Proposal

The table of contents (Part A), and amend to read:

"Contents

	<i>Page</i>
I. Statement of technical rationale and justification	
A. Phase 1	
1. Safety need	
...	
B. Phase 2	
1. Introduction and General Background	
2. Procedural Background	
3. Requirements	
4. Key elements of the amendment	
5. Recommendations and Limitations for introducing the flexible lower legform impactor	
6. Task Force Bumper Test Area (TF-BTA)	
...."	

Part A, statement of technical rationale and justification, renumber as I and amend to read:

"I. Statement of technical rationale and justification

A. Phase 1

0. Sections 1. to 10. reflect the development of phase 1 of gtr No. 9 and concern the legform test procedure with the lower legform impactor designed by the **European Enhanced Vehicle-Safety Committee (EEVC)** and the upper legform impactor for the high bumper vehicles as well as the headform test procedure.

1. Safety need

.....

10. Appendix

...

Number of working paper	Title of informal document
INF GR/PS/1 and Rev 1	Agenda 1st meeting
INF GR/PS/2	Terms of Reference of the GRSP Informal Group on Pedestrian Safety adopted by GRSP at its thirty first session
INF GR/PS/3	IHRA accident study presentation
INF GR/PS/4 and Rev 1	JMLIT proposed legislation - Comparison of draft regulations
INF GR/PS/5	IHRA feasibility study (doc. IHRA/PS/224 - Chapter 9)
INF GR/PS/6	Japanese proposal for the scope of Global Technical Regulations on Pedestrian Protection
INF GR/PS/7	Attendance list 1st meeting
INF GR/PS/8 and Rev 1	Draft Meeting Minutes 1st meeting
INF GR/PS/9 and Rev 1	Report of the First Meeting (Informal Document GRSP-32-07)
INF GR/PS/10	Draft GRSP/Pedestrian Safety Ad hoc Action Plan
INF GR/PS/11	Agenda 2nd meeting
INF GR/PS/12	Pedestrian Protection In Europe - The Potential of Car Design and Impact Testing (GIDAS Study)
INF GR/PS/13	Pedestrian Protection In Europe - The Potential of Car Design and Impact Testing (GIDAS Presentation)
INF GR/PS/14	Italy 1990 – 2000 [accident data]
INF GR/PS/15	Pedestrians killed in road traffic accidents [UN Statistics of Road Traffic Accidents in Europe and North America]
INF GR/PS/16	Pedestrians injury profile evaluation in a hospital-based multicenter polytrauma survey [Spanish accident data]
INF GR/PS/17	European Accident Causation Survey (EACS)
INF GR/PS/18	Draft Meeting Minutes 2nd meeting
INF GR/PS/19	Agenda 3rd meeting
INF GR/PS/20	Canadian Pedestrian Fatalities and Injuries 1990 – 2000

Deleted: Transport Research Laboratory (TRL)

Deleted: r

Deleted: Japan information on possible scope

Deleted: to

Deleted:

Deleted: inf doc

Deleted: a

Deleted: p

Deleted: accident data

Deleted: accident data graphs

Deleted: ian

Deleted: accident data

Deleted: ACEA accident data

Deleted: accident data

Number of working paper	Title of informal document
INF GR/PS/21	Data from the Netherlands for the years 1990-2001: Pedestrian and Cyclists Casualties
INF GR/PS/22	Vehicle Category (Proposal for the Scope)
INF GR/PS/23	Draft content preliminary report
INF GR/PS/24	Attendance list 3rd meeting
INF GR/PS/25	Extract from the GIDAS study for pedestrian safety
INF GR/PS/26	TARDA Leg Injury Data
INF GR/PS/27 and Rev 1	Draft Meeting Minutes 3rd meeting
INF GR/PS/28	Technical feasibility - general
INF GR/PS/29	Study of the Efficiency of Infrastructural Measures for Pedestrian Protection
INF GR/PS/30	Frequency of Pelvis/Femur Fractures for Pedestrians more than 11 Years
INF GR/PS/31	IHRA/PS-WG Pedestrian accident data
INF GR/PS/32	ESV summary paper on IHRA/PS-WG report
INF GR/PS/33	Introduction of the regulation of pedestrian head protection in Japan (Nishimoto/Toshiyuki, 18th ESV Conference, Nagoya 2003)
INF GR/PS/34	Proposal for a Directive of the European Parliament and the Council relating to the protection of pedestrians and other vulnerable road users in the event of a collision with a motor vehicle and amending Directive 70/156/EEC; Commission of the European Communities, Brussels, February 2003
INF GR/PS/35	List of conflicts with existing legislation requirements
INF GR/PS/36	Draft preliminary report
INF GR/PS/37	Agenda 4th meeting
INF GR/PS/38	Technical prescriptions concerning test provisions for pedestrian safety
INF GR/PS/39 and Rev 1	Vehicle safety standards report 1
INF GR/PS/40	US Cumulative 2002 Fleet GVMR
INF GR/PS/41	Swedish pedestrian fatalities 1994-2002
INF GR/PS/42	Proposal for a new draft global technical regulation concerning uniform provisions for common definitions and procedures to be used in Global Technical Regulations (TRANS/WP.29/GRSG/2003/10)
INF GR/PS/43	Vehicles of Category 1-1 in Japan
INF GR/PS/44	Light duty truck
INF GR/PS/45	Analysis of Euro NCAP data
INF GR/PS/46	Development of JAMA / JARI pedestrian child and adult headform impactors
INF GR/PS/47 and Rev 1	Preliminary report to GRSP 33 rd session
INF GR/PS/48 and Rev 1	Draft meeting minutes 4th meeting
INF GR/PS/49	IHRA child head test method
INF GR/PS/50	IHRA adult head test method
INF GR/PS/51	Attendance list 4th meeting
INF GR/PS/52	Provisional agenda for the 5th meeting
INF GR/PS/53	Draft gtr format
INF GR/PS/54	gtr proposal to WP.29
INF GR/PS/55	Proposal for a new draft gtr (Japan)
INF GR/PS/56 and Rev 1	Pedestrian Safety Comparison Table

- Deleted: accident data
- Deleted: overview
- Deleted: table
- Deleted: presentation
- Deleted: Leg injuries
- Deleted: e effectiveness
- Deleted: Pelvis / Femur fracture
- Deleted: ;
- Deleted: ;
- Deleted: d
- Deleted: /
- Deleted: accident data
- Deleted: proposal for common definitions
- Deleted: GVM
- Deleted: URO-
- Deleted: results and what they mean in relation to EU Phase 1
- Deleted: D
- Deleted: t

Number of working paper	Title of informal document
INF GR/PS/57	Pedestrian Safety GTR Preparation Schedule (Draft)
INF GR/PS/58	Contents of headform test procedure
INF GR/PS/59	Comments on windscreen/A pillars as headform test area
INF GR/PS/60	Document ISO/TC22/SC10/WG2 N613
INF GR/PS/61	IHRA Computer simulation results (document IHRA/PS 237)
INF GR/PS/62	Action plan from 5th meeting
INF GR/PS/63	Attendance list 5th meeting
INF GR/PS/64 and Rev 1	Draft meeting minutes 5th meeting
INF GR/PS/65 and Rev 1	Provisional agenda for the 6th meeting
INF GR/PS/66	Australian NCAP pedestrian report
INF GR/PS/67	CLEPA proposal for a test method - active hood / bonnet systems
INF GR/PS/68	Initial Assessment of Target Population for Potential Reduction of Pedestrian Head Injury in the US (Mallory/Stammen 2004)
INF GR/PS/69 and Rev 1	Proposed draft global technical regulation (gtr) on pedestrian protection - Transmitted by OICA
INF GR/PS/70	Current Status in Korea for Pedestrian Safety Rule-making Researches
INF GR/PS/71	Possibility to define an impact zone in the windscreen/A-pillar area to fulfil HIC criteria
INF GR/PS/72	Head impact to windscreen
INF GR/PS/73	Re-assessment of headform impactor test parameters
INF GR/PS/74	Specification of headform impactor (document IHRA/PS 270)
INF GR/PS/75	"Active hood" systems test method - CLEPA proposal
INF GR/PS/76	IHRA Discussions on Legform Test - Reviewing the 14th IHRA Meeting Minutes
INF GR/PS/77	UVA Dynamic Bending Corridors for Mid-Thigh, Knee, and Mid-Leg; Explained by JARI instead of UVA
INF GR/PS/78	Explanation of the Bio-Rating Method of Maltese M. R. (NHTSA) and Application the Method to Flex-PLI 2003R using UVA Dynamic Bending Corridors for Mid-Thigh, Knee, and Mid-Leg
INF GR/PS/79	[IHRA anthropometric leg proposal]
INF GR/PS/80	IHRA developed/IHRA recommendation to GTR [IHRA/PS/278]
INF GR/PS/81	Schedule for legform impactor for gtr
INF GR/PS/82	Discussion on Injury Threshold for Pedestrian Legform Test
INF GR/PS/83	Action plan / decisions resulting from the 6th meeting
INF GR/PS/84	Draft meeting minutes of the 6th meeting
INF GR/PS/85	Attendance list of the 6th meeting
INF GR/PS/86 and Rev 1 / 2	Proposed draft global technical regulation (gtr) on pedestrian protection
INF GR/PS/87	Development of a biofidelic flexible pedestrian leg form impactor [document IHRA PS 273]
INF GR/PS/88	Second interim report to GRSP 35
INF GR/PS/89	A study on the feasibility of measures relating to the protection of pedestrians and other vulnerable road users. Final Report. [European Commission]
INF GR/PS/90	Provisional agenda for the 7th meeting
INF GR/PS/91	Study on Technical Feasibility of EEVC WG17 (Matra/ACEA)
INF GR/PS/92	Equal Effectiveness Study on Pedestrian Protection (TU Dresden/ACEA)
INF GR/PS/93	Design of JAMA/JARI pedestrian headform impactor

Deleted: Proposed s...chedule (Dr (... [1])

Deleted: Presentation on vehicle shape, boundary line, ...

Deleted: A-pillar IHRA OICA presentation

Deleted:

Deleted: US-...CAP pedestrian da (... [2])

Deleted: T...est - (... [3])

Deleted: p...opulation for Potentia (... [4])

Deleted: Working paper draft gtr

Deleted: n ...for Pedestrian Safety (... [5])

Deleted: Head test area windscreen + A-pillar

Deleted: test data on

Deleted: Head impact angle / speed re-assessment based on vehicle geometry

Deleted: IHRA/PS/270 ...pecifica (... [6])

Deleted: Powerpoint explanation of PS/67

Deleted: IHRA legform discussions

Deleted: Corridors proposed by UVA (lower legform)

Deleted: Bio rating method: Maltese

Deleted: t...hreshold for p...edest (... [7])

Deleted: Decided items and action items of

Deleted: Draft gtr EU working document

Deleted: ...PS ...273] Developm (... [8])

Deleted: EU Feasibility Study Phase 2

Deleted: ACEA ...tudy on Techni (... [9])

Deleted: ACEA e...qual e...ffec (... [10])

Number of working paper	Title of informal document
INF GR/PS/94	J-NCAP Pedestrian Headform Test - HIC Values in Windshield Impact
INF GR/PS/95	Proposed Global Technical Regulation (GTR) on Pedestrian Protection - JPN comment on PS-86-Rev 2
INF GR/PS/96	Problem of Undamped Accelerometer in Headform Impact Test - Generation of Abnormal Acceleration in Headform Impact Tests - Causes and Solutions
INF GR/PS/97	Durability and repeatability of headform skin
INF GR/PS/98	IHRA/PS Decisions for the IHRA/PS Legform Test Procedures - IHRA/PS Working Group (IHRA PS 310)
INF GR/PS/99	Aging Effect of PVC Headform Skin on the Drop Certification Testing
INF GR/PS/100	OICA proposed amendments to INF/GR/PS/86/Rev.2 J - 28 September 2004
INF GR/PS/101	JAMA Technical Feasibility Study on EEVC/WG17 - Pedestrian Subsystem Test
INF GR/PS/102	Windscreen Tests according to Euro NCAP Protocol (Example)
INF GR/PS/103	[Windscreen & A-pillar testing on one car model]
INF GR/PS/104	Minimum Standard for Type Approval Testing of Active Deployable Systems of the Bonnet / Windscreen Area (CLEPA/OICA)
INF GR/PS/105	Human Biomechanical Responses to support the Design of a Pedestrian Leg Impactor
INF GR/PS/106	Information on the Flexible Pedestrian Legform Impactor (Flex-PLI) from J-MLIT Research
INF GR/PS/107	Knee ligament figure
INF GR/PS/108	Comment for IHRA or GTR regarding Legform Test
INF GR/PS/109	[Flex-PLI as a certification tool]
INF GR/PS/110	DRAFT: Definition of the windscreen reference lines
INF GR/PS/111 and Rev 1	Pedestrian Safety Global Technical Regulation Preamble [draft and guideline]
INF GR/PS/112	Action plan resulting from the 7th meeting
INF GR/PS/113	Proposed Draft Global Technical Regulation (GTR) on Pedestrian Protection
INF GR/PS/114	Attendance list 7th meeting
INF GR/PS/115 and Rev 1	Draft meeting minutes of the 7th meeting
INF GR/PS/116	Proposed Draft Global Technical Regulation (GTR) on Pedestrian Protection [working version]
INF GR/PS/117	Proposed Draft Global Technical Regulation (GTR) on Pedestrian Protection [Proposal for 37th GRSP]
INF GR/PS/118 and Rev 1	Provisional agenda for the 8th meeting
INF GR/PS/119	Proposal from the Chairman to include the history of ISO work in the Preamble under item III. Existing Regulations, Directives, and International Voluntary Standards
INF GR/PS/120	A study on the feasibility of measures relating to the protection of pedestrians and other vulnerable road users - Addendum to Final Report (EC)
INF GR/PS/121	TRANS/WP.29/GRSP/2005/3 incl. amendments of the 37th GRSP session
INF GR/PS/122	GRSP-37-18 – USA Comments on Draft GTR on Pedestrian Head and Leg Protection (TRANS/WP.29/GRSP/2005/3)
INF GR/PS/123	GRSP-37-15 - Japan's Comment to TRANS/WP.29/GRSP/2005/3
INF GR/PS/124	GRSP-37-16 - Flex-PLI Technical Evaluation Group (Flex-PLI TEG) Activities
INF GR/PS/125	Short report on comments received during GRSP-37
INF GR/PS/126	Request for submission of the justifications for PS gtr proposal [task list]
INF GR/PS/127	Pedestrian Protection Phase 2 [EU]

- Deleted: Front windshield
- Deleted:
- Deleted:
- Deleted: + English text of Japanese technical standard
- Deleted: u
- Deleted: a
- Deleted: decision for legform test
- Deleted: Skin a
- Deleted: head impactor
- Deleted: PS/95
- Deleted: f
- Deleted: s
- Deleted: Phase 2
- Deleted: OICA w
- Deleted: t
- Deleted: ing
- Deleted: EURO-
- Deleted: p
- Deleted: CLEPA w
- Deleted: Draft
- Deleted:
- Deleted:
- Deleted: document on active bo (... [11])
- Deleted: Lower leg research for (... [12])
- Deleted: proposal for FlexPLI ar (... [13])
- Deleted: NHTSA proposal for g (... [14])
- Deleted: JAMA information on l (... [15])
- Deleted: Chairman proposal for (... [16])
- Deleted: OICA proposal for side and rear
- Deleted: G
- Deleted: for preamble
- Deleted: Revision of draft gtr
- Deleted: Cleaned up version of draft gtr
- Deleted: Preamble and draft gtr (... [17])
- Deleted: ISO Activities for Pedef (... [18])
- Deleted: final feasibility study
- Deleted: as
- Deleted: ed
- Deleted: during
- Deleted: /37
- Deleted: July meeting
- Deleted: Presentation on EU

Number of working paper	Title of informal document
INF GR/PS/128	The need for harmonized legislation on pedestrian protection
INF GR/PS/129	Comparison of the severity between the Japanese regulation based on IHRA and Phase 2 proposal based on EEVC
INF GR/PS/130	Derivation of [head] impact direction; extract from Glaeser 1995
INF GR/PS/131	Analysis of pedestrian accident situation and portion addressed by this gtr
INF GR/PS/132	GTR Head Tests of US Fleet Vehicles
INF GR/PS/133 and Rev 1	Miniature Damped Accelerometer Series Kyowa ASE-A
INF GR/PS/134	Head Impact Tests in the Centre of the Windscreen
INF GR/PS/135	Definition of Windscreen Lower Reference Line
INF GR/PS/136	Action 10 of INF GR/PS/112: Clarification of values upper legform/bumper
INF GR/PS/137	Definition of High Bumper Vehicles
INF GR/PS/138	Economic Appraisal for Technical Regulation on Pedestrian Protection, focused on head protection
INF GR/PS/139	Action items from the 8th meeting
INF GR/PS/140	IHRA Injury Breakdown (All Ages)
INF GR/PS/141	Certification Standard for Type Approval Testing of Active Deployable Systems of the Bonnet Area and Rev 1
INF GR/PS/142	Relative humidity of Korea
INF GR/PS/143 and Rev 1	Draft gtr based on INF GR/PS/121 as amended during the 8th meeting
INF GR/PS/144 and Rev 1	Draft meeting minutes of the 8th meeting
INF GR/PS/145	Attendance list 8th meeting
INF GR/PS/146	Flex-PLI TEG Activities
INF GR/PS/147	Proposals from Mr Césari for amendments to the preamble as agreed in the action items INF GR/PS/139
INF GR/PS/148	Assessment of the FTSS 4.5 kg aluminium headform as a possible alternative for EEVC WG17
INF GR/PS/149	New Requirement Proposal for the GTR Adult Headform Impactor Specification - Moment of Inertia
INF GR/PS/150	Development of a Head Impact Test Procedure for Pedestrian Protection (Glaeser, 13th ESV Conference, Paris 1991)
INF GR/PS/151	Proposed wording by Japan for the preamble on the headform (damped) accelerometer issue
INF GR/PS/152	Provisional agenda for the 9th meeting
INF GR/PS/153	Explanation of amendments to INF GR/PS/143 resulting in INF GR/PS/143 Rev. 1
INF GR/PS/154 and Rev 1	Handling Guideline for the EEVC WG17 Legform Impactor (Draft) and (Version 1.0)
INF GR/PS/155	Proposal for a Definition of the Lower Windscreen Reference Line and Justification
INF GR/PS/156	Proposal for Impact Angles for Headform to Windscreen Tests and Justification
INF GR/PS/157	Proposal for HIC Limits for Headform to Windscreen Tests and Justification
INF GR/PS/158	Proposal for New Criteria for Headform Impactor to Bonnet Tests and Justification
INF GR/PS/159	Proposal for a Definition of Vehicles with High Bumpers and Justification
INF GR/PS/160	Revised preamble replacing the preamble in doc. INF GR/PS/143 Rev. 1
INF GR/PS/161 and Rev 1	EU proposed amendments to doc. INF GR/PS/143 Rev. 1
INF GR/PS/162	Explanation of EU proposals (in INF GR/PS/161) to amend INF GR/PS/143 Rev. 1

Deleted: standard ...nd the EU ... [19]

Deleted: List of references for EU / EEVC on head impact angles

Deleted: gtr testing and what it means for the ...S Fleet Vehiclesituation ... [20]

Deleted: Proposal to solve the ... [21]

Deleted: Concerns on §7.4 with ... [22]

Deleted: OICA proposal for §3.33

Deleted: OICA proposal for a mass for the ...pper legform/ impactor ... [23]

Deleted: OICA proposal on d...c ... [24]

Deleted: effectiveness study from Korea

Deleted: list of

Deleted: b...reakdown backgrou ... [25]

Deleted: Update of PS67 on ... [26]

Deleted: updating PS/124

Deleted: Actions 1 3 4 6 9 of 8th meeting

Deleted: Action 9 of 8th meeting doc FTSS_4[1].5kg_headform

Deleted: h...eadform Impactor ... [27]

Deleted: h...ead i...mpact t...est ... [28]

Deleted: gtr...preamble on the h... [29]

Deleted: from ...o INF GR/PS/1... [30]

Deleted: g...uideline for the TRI... [31]

Deleted:

Deleted: definition

Deleted: a...ngles for h...eadform ... [32]

Deleted: l...imits for h...eadform ... [33]

Deleted: b...onnet t ... [34]

Deleted: h...igh b...umpers vehi ... [35]

Deleted: / 2

Number of working paper	Title of informal document
INF GR/PS/163	SUV - Windshield Head Impacts
INF GR/PS/164	Observation of different windscreen glass fracture modes during headform impactor tests
INF GR/PS/165	Leg feasibility testing
INF GR/PS/166	Relaxation zone and GVWR application for US
INF GR/PS/167	EU field data on crossbeam height
INF GR/PS/168	Relationship between HIC15, HIC36, Peak Acceleration and Pulse duration
INF GR/PS/169	Revised Analysis of Pedestrian Accident Situation and Portion Addressed by this GTR
INF GR/PS/170	Draft preamble: Target population for this gtr
INF GR/PS/171	Draft meeting minutes of the 9th meeting
INF GR/PS/172	Attendance list 9th meeting
INF GR/PS/173	Provisional agenda for the 10th meeting
INF GR/PS/174 and Rev 1	Euro NCAP test results, Phase 12 – 17, lower leg tests - OICA presentation for Jan 2006 meeting
INF GR/PS/175 and Rev 1 / 2	Lower/Upper Bumper Reference Lines, Data on existing vehicles - OICA presentation for Jan 2006 meeting
INF GR/PS/176 and Rev 1 / 2	Headform test data - OICA presentation for Jan 2006 meeting
INF GR/PS/177	IHRA/PS Proposal for the Moment of Inertia of gtr Adult/Child Headform Impactors
INF GR/PS/178	Expected life-saving of introducing the GTR Head Protection Regulation in Japan
INF GR/PS/179	Ongoing Researches on Pedestrian Leg Injuries Assessment Performed by INRETS in Relation with EEVC WG 17
INF GR/PS/180	OICA position on the change of the definition of the ble reference line
INF GR/PS/181	Lower Extremity Pedestrian Injury in the US: A Summary of PCDS Data (from IHRA/PS 333)
INF GR/PS/182	Factor causing scatter in dynamic certification test results for compliance with EEVC WG17 legform impactor standard (Matsui/Takabayashi, IJCrash 2004 Vol. 9 No. 1 pp. 5–13)
INF GR/PS/183	OICA position on bonnet leading edge 165 mm exemption zone
INF GR/PS/184	Final draft gtr (without preamble)
INF GR/PS/185	Mr Saul letter dated on 3/1/2006
INF GR/PS/186	NHTSA revision of preamble PS/160
INF GR/PS/187	EEVC WG17 report December 1998 and with September 2002 updates
INF GR/PS/188	Draft meeting minutes of the 10th meeting
INF GR/PS/189	Attendance list 10th meeting

Deleted: creen
 Deleted: i
 Deleted: testing
 Deleted: W

Deleted: HIC15 vs HIC36 headaccel analysis
 Deleted: Revising PS/131 ~ Analysis of Pedestrian Accident and gtr Application

Deleted: Lower leg tests -
 Deleted:
 Deleted: data
 Deleted: results

Deleted: -
 Deleted: effect_gtr_Head_

Deleted: Comparison lower leg injuries for different AIS levels
 Deleted: Foam memory for changing humidity

B. Phase 2

133. Sections 1. to 6. reflect the development of Phase 2 of gtr No. 9 and concern the legform test procedure with the flexible lower legform impactor (FlexPLI) without changing the requirements for the upper legform impactor and the test procedure for the high bumper vehicles as well as the headform impactors and the respective test procedures.

Deleted: and

1. Introduction and General Background

134. At the thirty-sixth session of GRSP (7-10 December 2004) the expert from Japan proposed to evaluate the possibility to replace the European Enhanced Vehicle Safety Committee (EEVC) lower legform impactor by a flexible lower legform impactor. For this reason, a technical evaluation group (TEG) was established by GRSP.

135. Under the chairmanship of Japan, the TEG prepared a draft proposal submitted by Japan for the May 2011 session of GRSP to introduce the flexible lower legform impactor in the global technical regulation (gtr) No. 9 on pedestrian safety¹. After the review, GRSP resumed that pending issues should be addressed by a reconstituted Informal Working Group (IWG).

136. The representatives of Germany and Japan proposed the development of Phase 2 (PH2) of the global technical regulation (gtr) No. 9 on pedestrian safety. The main objective of PH2 is the development of a draft proposal to amend gtr No. 9 by introducing the flexible pedestrian legform impactor (FlexPLI) as a single harmonized test tool aimed at enhancing the level of protection for the lower legs of pedestrians.

137. The work of the IWG shall not be limited to draft proposals to amend the gtr No. 9, but shall cover the development of a complementary draft proposal to amend Regulation No. 127.

138. The IWG should also review proposals to improve and/or clarify aspects of the legform test procedure.

139. The changes introduced by this amendment do not intend to change the severity of the original requirements significantly. However, with the introduction of the flexible lower legform impactor, Contracting Parties and domestic economic integration organizations are able to adopt, by preference, a particular tool with superior performance into their national or domestic legislation.

2. Procedural Background

140. At its forty-ninth session, GRSP considered ECE/TRANS/WP.29/GRSP/2011/13 and GRSP-49-15 concerning the introduction of the flexible pedestrian legform (FlexPLI) into the gtr. The expert from the United States of America (USA) gave a presentation on the outcome of a comparison research study conducted in his country between the FlexPLI and the current lower legform. He concluded that additional research, testing and additional world fleet data would be needed to address the injury criteria concerns and to justify introducing on the FlexPLI. The expert from Japan gave a presentation (GRSP-49-24), showing that the FlexPLI and the current legform have totally different structures and injury criteria. Therefore, he concluded that direct comparison between the two legforms would give misleading results. GRSP agreed that pending issues should be addressed by an IWG, co-chaired by Germany and Japan. The IWG would finalize proposals for introducing the FlexPLI into the gtr and, simultaneously, into the draft Regulation on pedestrian safety in the same time.

141. GRSP agreed to seek consent from WP.29 and the Executive Committee of the 1998 Agreement (AC.3) at their June 2011 sessions to mandate an IWG on the

Deleted: .

Deleted: Informal Working Group (

Deleted:)

Deleted:

¹ The final report of the TEG is available as documents ECE/TRANS/WP.29/GRSP/2011/13 and GRSP-49-15, the documents discussed are listed in document GTR9-C-08 of the constitutional meeting of the IWG and are stored in the section "FlexPLI subgroup" of the first Informal Group on Pedestrian Safety.

FlexPLI. GRSP also noted the draft terms of reference of the IWG (GRSP-49-38) and agreed to refer to this group for finalization. Finally, it was agreed to resume consideration on this agenda item on the basis of revised proposals, if any.

142. At the 154th session of the WP.29 the representative of the USA informed AC.3 that, as an outcome of a research study conducted in her country, concerns were expressed by her delegation at the May 2011 session of GRSP on the readiness of the FlexPLI as a test tool. She added that GRSP had agreed that pending issues should be addressed by a reconstituted IWG. The representative of Germany clarified that the IWG, named informal working group on global technical regulation No. 9 phase 2 (IWG GTR9-PH2), would be co-chaired and co-sponsored by Germany and Japan with the secretariat tasks assigned to the International Organization of Motor Vehicle Manufacturers (OICA). AC.3 gave its consent to mandate the IWG subject to submission of appropriate terms of references to AC.3. It was agreed to set up an IWG to solve the pending issues on incorporating the FlexPLI into PH2 of gtr No. 9 and in Regulation No. 127 on pedestrian safety.

143. The Chair of GRSP reported on the forty-ninth session where GRSP agreed to seek the consent of WP.29 and AC.3 to mandate a new informal group to solve the pending issues for incorporating on the FlexPLI in Phase 2 of the gtr No. 9 and in the draft Regulation on pedestrian safety at the same time. The World Forum agreed to set up this IWG, subject to the submission to WP.29 of the appropriate terms of references.

144. The IWG started its work on 3 November 2011 with a constitutional meeting in Bonn (Germany) to draft the terms of references, the rules of procedure, the time schedule and the work plan. There, the participants also agreed with the proposal by the co-sponsors that the IWG would be managed by Germany (Chair), Japan (Vice-Chair) and that the International Organization of Motor Vehicle Manufacturers (OICA) would perform the tasks of the secretariat.

145. At the 155th session of WP.29 and the thirty-third session of AC.3, Germany and Japan informed delegates about the outcome of the constitutional meeting, the management of the group and the ongoing activities of the IWG (document WP.29-155-35). WP.29 and AC.3 noted that the first meeting of the IWG was planned for 1 and 2 December 2011 to start the technical discussion and to finalize the draft terms of references as well as the work plan for submission to GRSP at its December 2011 session.

146. The first meeting of IWG was held on 1 and 2 December 2011 in Geneva (Switzerland). The technical discussion started and the draft document on the terms of reference, the rules of procedures, the time schedule and the work plan for submission to GRSP in December 2011 were concluded. The first progress report was submitted to GRSP in December 2011 and to WP.29 at its 156th session as well as to AC.3 at its thirty-fourth session in March 2012. At its 156th session, the World Forum, endorsed, in principle, the noted terms of references, pending the adoption of the report of the December 2011 session of GRSP. AC.3 also endorsed, in principle, the terms of reference of the IWG and requested the secretariat to distribute WP.29-156-11 with an official symbol for consideration at its June 2012 session.

147. The second meeting of the IWG took place in Osaka (Japan) on 28 and 29 March 2012. The discussion focused on the technical aspects including the accident and benefit analysis. High priority was given to the activities on the further development of the certification procedures. As a further work item, a task force was established to initiate the work on the bumper test area for the lower legform impact.

Deleted: principle

148. The second progress report was submitted to GRSP in May 2012 and to WP.29 for consideration at its 157th session and to AC.3 at its thirty-fifth session in June 2012. During these sessions, the first progress report (ECE/TRANS/WP.29/2012/58) and the terms of references including the rules of procedures, the time schedule and the work plan were formally adopted. The second progress report (WP.29-157-21) was distributed with an official symbol at the November 2012 sessions of WP.29 and AC.3.

149. The third meeting of the IWG was held on 29 and 30 May 2012 in Paris (France). During the meeting, the experts discussed main topics related to accident data on pedestrian injuries, the cost-benefit assessment and the set-up of certification corridors.

150. The fourth meeting of the IWG took place on 17 to 19 September 2012 in Washington, D.C. (United States of America). The group resumed discussions from the third meeting, while the main focus was given to finalizing the certification corridors and the cost-benefit assessment for introducing the FlexPLI. Priority was given to agree on an international round robin vehicle test programme with the FlexPLI.

151. The draft third progress report was submitted to WP.29 at its 158th session and to AC.3 at its thirty-sixth session. AC.3 requested the secretariat to distribute the draft third progress report (WP.29-158-28) with an official symbol for consideration at the next session and adopted the second progress report (ECE/TRANS/WP.29/2012/120).

152. The fifth meeting was held on 6 and 7 December 2012 in Bergisch Gladbach (Germany). Main discussions during this meeting were the review of the cost-benefit analysis, an exchange of information on the first results of the repeatability and reproducibility of the FlexPLI tests with vehicles, and a discussion on the threshold values for the injury criteria. Furthermore, the IWG agreed to seek the consent of GRSP and WP.29/AC.3 for extending the mandate (working schedule) to take all test results into account for the amendment of the gtr.

153. Delegates noted that GRSP had adopted the revised terms of reference of the IWG group as reproduced in Annex II to the GRSP report (ECE/TRANS/WP.29/GRSP/52) during the 159th session of WP.29 and at the thirty-seventh session of AC.3. The World Forum endorsed the extension of the mandate of the IWG until June 2014 (expected adoption at WP.29/AC.3) and, in principle, the revised terms of references, pending the adoption of the GRSP report of its December 2012 session at the 160th session of the World Forum in June 2013.

154. The third progress report (ECE/TRANS/WP.29/2013/36) was recalled at the 159th session of WP.29 and at the thirty-seventh session of AC.3 together with the amendments proposed by GRSP (WP.29-159-20) at the December 2012 session. AC.3 adopted ECE/TRANS/WP.29/2013/36, as amended by Annex III of the report of that session of WP.29 (ECE/TRANS/WP.29/1102).

155. The sixth meeting of the IWG took place in Washington, D.C. from 19 to 20 March 2013. The group agreed on the approach to review the FlexPLI drawing package to prepare the addendum of the Mutual Resolution No. 1 (M.R.1). The review of the controversial discussion on the cost-benefit studies was finalised and the results of the different regions and laboratories on the vehicle repeatability and reproducibility tests were discussed.

156. The draft fourth progress report of the IWG was presented at the fifty-third session of GRSP. It was added that the group had made good progress and that it was

ready to submit an official proposal to the December session of GRSP with possible pending decisions on threshold values of injury criteria. GRSP agreed to resume consideration of this subject on the basis of a proposal submitted by the IWG.

157. At the 160th WP.29 session, the experts were informed by the representative of the United States that GRSP was expected to recommend that Amendment 2 (Phase 2) of the gtr on pedestrian safety, aimed at including the FlexPLI and the definition of the head form impact point be included into the gtr No. 9 test as well as into Regulation No. 127. He also announced the submission of another amendment to the gtr on pedestrian safety on an updated definition of the head form impact point.

158. At the same session, the representative of Japan, Vice-Chair of the IWG on Phase 2 of gtr No. 9, introduced the fourth progress report of the group together with a presentation. He confirmed the good progress of the IWG and that an official proposal for incorporating the flexible pedestrian legform impactor would be submitted to the December 2013 session of GRSP. AC.3 adopted the fourth progress report and requested the secretariat to distribute it with an official symbol at its November 2013 session.

159. The seventh meeting of the IWG was (3 July 2013) a telephone and online meeting. The group discussed specific issues, especially regarding the threshold values for the injury criteria, the definition of the rebound phase and the tolerances of FlexPLI output values during the free-flight phase. The latter two were agreed in principle while a decision on the threshold values is still pending. A further work item agreed would be an analysis on the necessity and possibility of introducing certification corridors for the femur bending moment.

160. The eighth meeting of the IWG was held on 09 and 10 September 2013. The meeting was dedicated mainly to discuss the open items like the injury criteria, the femur certification corridors and to review the preamble and the regulatory text of the gtr No. 9.

161. The ninth meeting of the IWG was held on 16 and 17 December 2013. During the meeting open items were discussed and resolved during the final review of the proposed amendment of the text for the gtr and the UN-Regulation 127. One pending issue on the performance limits for the injury criteria has to be discussed within GRSP involving all Contracting Parties.

3. Requirements

(a) Assessment of biofidelity

162. Japan Automobile Standard Internationalization Centre (JASIC) highlighted the improved biofidelity of the FlexPLI compared to the legform impactor currently used in gtr No. 9. The superior biofidelity was shown at component and assembly level using both the testing and the simulation tools. The improvements in the knee and tibia area were presented. A comparison study of the FlexPLI and post-mortem human subject (PMHS) test data was done for the performance limits. The FlexPLI was shown as more human-like with regard to the injury mechanism of the tibia.

163. The biofidelity study was performed with data from Japan and the USA. Some concerns were raised by the Alliance of Automobile Manufacturers on the validity of the method used by JASIC in comparing the finite element models with human body models. These concerns were not shared by the expert from Japan.

Deleted: a

Deleted: 0

Deleted: 1

164. The expert from United Kingdom of Great Britain and Northern Ireland (UK) expressed that the FlexPLI could have limitations in assessing knee injuries. The expert from Japan explained that both, knee injuries and tibia fractures could be assessed. But during the development, higher priority was given to tibia fractures as the knee injuries are less represented compared to tibia fractures according to the accident data analyses.

Deleted: 2

165. The IWG received additional information on the superior performance of the FlexPLI compared to the current lower legform impactor.

Deleted: 3

166. The discussion on the limitations of the FlexPLI in assessing knee injuries was closed pending the submission of new information on this subject.

Deleted: 4

(b) Costs benefits analysis

167. At start phase of the IWG, participants were asked to provide accident data. This request was also raised at the fiftieth session of GRSP by the Chair of the IWG. The expert of the USA informed the IWG that they were investigating if information on accidents with pedestrians could be supplied for discussion.

Deleted: 5

168. The expert from the National Highway Traffic Safety Administration (NHTSA) informed delegations about a research project in the USA to investigate the accident situation for pedestrians using the Pedestrian Crash Data Study (PCDS) and the German In-Depth Accident Study (GIDAS). The analyses only covered AIS 3-6 injuries and looked at disabling injuries according to the Functional Capacity Index (FCI) based on AIS.

Deleted: 6

169. According to both data sources, bumper-caused injuries represent up to 40 per cent of all pedestrian injuries. Notwithstanding, there are notable differences between the two sources on the number of injuries to the different body regions: the number of injuries to lower extremities are primarily caused by the bumper; and is in both cases close to 100 per cent (94 per cent for PCDS and 99 per cent for GIDAS). The presentation also showed the ranking of injured body regions for serious and disabling injuries, with the most frequent combination being the lower extremity to bumper impact.

Deleted: 7

170. The German Federal Highway Research Institute (BAST) submitted detailed information on the expected reduction of costs in Germany due to the introduction of the FlexPLI within the test procedures according to gtr No. 9. The study was based on both, national accident data as well as German in-depth accident data, using the injury shifting method. Here, the assumption was made that in case of a pedestrian being struck by a passenger car equipped with a frontend system designed for the protection of pedestrians, all corresponding AIS 1-3 injuries related to lower extremities could be shifted downwards by -1. In total, 498 accidents were vehicles to pedestrian in the German in-depth study GIDAS. As a result, the study concluded that due to pedestrian friendly bumper designs, 25 per cent of all Maximum Abbreviated Injury Scale (MAIS) 3 injuries could be shifted to MAIS 2, and almost 8 per cent of all MAIS 2 injuries could be shifted to MAIS 1. Finally, the portion of MAIS 1 injuries would increase by approximately 2.5 per cent.

Deleted: 68

171. Applying this shifted injury distribution to the national database, the introduction of pedestrian friendly bumper designs was estimated at an annual decrease of 11 fatally injured pedestrians and an annual decrease of 506 severely injured pedestrians. In the same period of time, the number of slightly injured pedestrians would increase by 231. Finally, the maximum annual cost reduction in Germany due to vehicles designed with pedestrian friendly bumpers was calculated at approximately € 63.5 million. According to an injury risk function developed by

Deleted: 69

Deleted: ,

JASIC based on Nyquist and Kerrigan PMHS data and using the Weibull survival model, a 30 per cent tibia bone fracture risk when complying with the proposed FlexPLI tibia bending moment requirement of 340 Nm was calculated at 330 Nm bending moment of the human tibia. Thus, under consideration of a 70 per cent injury risk that is consistently assumed to be covered by the FlexPLI, the annual cost reduction due to the introduction of the FlexPLI was calculated by BAST at approximately €44.5 million.

172. JASIC introduced detailed information on the possible benefit to tibia injuries that can be expected with the introduction of the FlexPLI. Based on accident data, it was presumed that tibia fractures mainly occur due to indirect loading (approximately 80 per cent). Only in a minor number of cases, the fracture of the tibia occurs due to direct loading of the bumper. It was also shown that the most significant improvement can be achieved by mitigation of leg fractures.

173. It was concluded that the FlexPLI can provide improved biofidelity for the tibia and the knee. Compared to the currently used legform impactor the cost savings due to mitigation of tibia fractures were estimated to be 100 million United States dollars for the USA and 50 million United States dollars for Japan based on calculation models using the annual medical costs for such types of injuries.

174. At the second meeting, the experts again reviewed the information from JASIC on the benefit of the FlexPLI, showed a significantly better biofidelity of the FlexPLI compared to the current legform impactor. It was concluded that the cost savings due to mitigation of tibia fractures were estimated to be around 77 million United States dollars for Japan based on calculation models using the annual economic cost for such types of injuries.

175. The expert from the Alliance of Automobile Manufacturers in the USA (Alliance) explained that the USA accident data used in the study might be processed in another way, as the current procedure in using the police-reported injury severity system KABCO (K - fatal, A - incapacitating, B - non-incapacitating, C - possible injury, O - no-injury) to classify injury severity might not be correct for pedestrian injuries. The expert from JASIC admitted that for some cases the injury severity classification based on the KABCO scale used for the study was not correct. A modified version of the study showed better results than the original document.

176. At the third and fourth meeting the pedestrian experts again reviewed JASIC information on the benefit of the FlexPLI. The Alliance had undertaken an investigation of the methodology that was presented by JASIC. One major concern of the Alliance was that the data used in the JASIC analysis does not correctly reflect the current accident situation in the United States due to the outdated data set and the assumptions for the injury levels taken as a basis for the benefit calculation.

177. During the fifth and the sixth meeting, the pedestrian experts further reviewed information from JASIC and the Federal Highway Research Institute of Germany (BAST) on calculating the benefits that would result from introducing the FlexPLI. The Alliance of Automobile Manufacturers in the USA repeated the concerns that the two approaches presented may not be valid for every market depending on the situation of accidents and the vehicle fleet.

178. The IWG finally agreed that this argument may be valid for some regions which would result in the need to undertake, within the individual countries or regions, a cost-benefit analysis using their national or regional data on accidents and the situation of the domestic vehicle fleet to verify the scope of the new provisions and the possible introduction of the FlexPLI in their territory.

Deleted: 0

Deleted: 1

Deleted: ,

Deleted: 2

Deleted: 3

Deleted: 4

Deleted: 5

Deleted: 6

(c) Technical specifications (drawings) and PADI (user manual)

179. Several items were raised on the user manual for the FlexPLI. An updated user manual incorporating the proposals was drafted including additional information for a visual inspection of the impactor.

Deleted: 7

180. Experts were informed that the drawings and specifications of the FlexPLI would be needed before the regulatory text can be approved by GRSP and adopted by WP.29 and AC.3. Humanetics confirmed that this is well known and such information would be submitted to the IWG.

Deleted: 78

181. The expert from OICA asked for more transparent documentation on the set-up of the flexible pedestrian legform impactor. The expert from the Humanetics confirmed that information would be provided if the documentation for the FlexPLI could be made available for the informal group with a disclaimer against its use for commercial purposes.

Deleted: 79

182. The expert from the UK informed the participants about the ongoing activity at WP.29 to set up a repository that would form a kind of library for dummies and other test devices used in regulations. He informed GRSP that the experts from UK and the USA were jointly preparing a mutual resolution (M.R.1.) of the 1958 and 1998 Agreements on the description and performance of test tools and devices necessary for assessing the compliance of wheeled vehicles, equipment and parts according to the technical prescriptions specified in Regulations and global technical regulations.

Deleted: 0

183. The IWG GTR9-PH2 was informed about a proposal of global technical regulation No. 7 (gtr No. 7), Phase II on the BioRID developed by the IWG working on this subject, where it was agreed that engineering drawings of dummies and dummy parts would be shared but not production drawings. The current proposal foresees that drawings would be made available during the discussion period only for information purposes and covered by a disclaimer that it may not be used for commercial purposes. The disclaimers would be withdrawn when dummies and dummy parts were agreed upon and engineering drawings would be made available.

Deleted: 1

184. It was then noted that the M.R.1 was adopted on 14 November 2012 by WP.29 (ECE/TRANS/WP.29/1101) and that Contracting Parties and manufacturers refer to this Mutual Resolution when establishing the suitability of their test tools and devices for assessing compliance with the prescriptions of Regulations or global technical regulations in the framework of the 1958 or 1998 Agreements respectively.

Deleted: 2

185. Humanetics provided a full drawing package for the FlexPLI in December 2012. The group discussed the plan to review the drawing package. It was agreed that a comparison of 100 per cent of the parts of one impactor would be done with the drawings. Additionally, the drawings would be checked for conformity with the requirements as defined by the IWG on Head Restraints Phase II, the IWG on Child Restraint Systems and the IWG GTR9-PH2. Only minor remarks for corrections resulted from the review of the drawing package.

Deleted: 3

186. IWG also reviewed the user manual for compliance with the defined requirements. Humanetics updated the drawings and the user manual with guidance from the IWG. A draft proposal for an addendum to the Mutual Resolution No. 1 (M.R.1) was prepared by the IWG.

Deleted: 4

(d) Evaluation of durability

187. The expert from OICA presented information on the long-term durability of the FlexPLI. Several items were mentioned, of which the durability of the bone core material led to extensive discussions. The bone core material suffers small cracks of

Deleted: 5

the material during the testing. While several experts mentioned that the performance is still acceptable with these minor damages, information was given by the company Bertrandt that deviations in the performance may be seen during calibration of the legform impactor. Experts would further investigate this issue and present further information on the long-term performance at the second meeting of the IWG. Investigations showed no major issue.

188. The expert from the USA presented further information on the durability of the FlexPLI. Comparison tests of the earlier and the current versions of the FlexPLI found that the durability had improved for the current version of the impactor and, therefore, was not a major issue for the moment.

(e) Test procedure

189. The experts from BAST, JASIC and OICA presented proposals to define the rebound phase for the FlexPLI test. While JASIC and OICA were of the opinion that a definition cannot be currently introduced into gtr No. 9, BAST showed a procedure to define a biofidelic assessment interval (BAI). The IWG finally agreed to introduce an assessment interval (AI) as the current most appropriate method to objectively determine the valid maxima of the measurements.

190. The expert from OICA presented a proposal for the vehicle set-up in terms of riding height. The proposal to cover tolerances in built-up, adjustment and alignment of a test vehicle in actual testing recommends including the concept of the primary reference mark. The definitions would give clearer guidelines needed to perform the type approval or self-certification tests of vehicles.

189. The experts from BAST and OICA proposed defining the tolerance of FlexPLI output values during the free-flight phase for vehicle tests. Based on a BAST proposal, definition for the free flight phase was introduced in the amendment.

(f) Certification tests

191. The IWG agreed a task force, chaired by Japan, for reviewing and updating the certification corridors (TF-RUCC) to resolve issues with the current certification test procedures. Certification tests were performed with several legforms in a limited number of labs to check the performance of the flexible pedestrian legform impactors. The objective of the task force was to prepare a recommendation for the IWG on the certification procedures and the corridors to be used for the certification of the FlexPLI.

193. The results showed a good and repeatable performance of the three flexible pedestrian legform impactors with the final build level (three "master legs") tested. A round robin certification test series confirmed a stable performance of the legform impactors. The task force finalized the work and succeeded in proposing updated certification corridors based on proposals made by BAST for the dynamic tests and by Japan Automobile Research Institute (JARI) for the static tests for the certification of the flexible legform impactors on the assembly and component level.

194. The corridors were agreed by the IWG as final. It was also indicated that an evaluation of the stability of performance of the flexible legform impactors would be done during vehicle testing.

(g) Review of test results

195. The expert from OICA introduced results of impactor to vehicle tests. He added that the results were quite promising but for some peak values a deviation of up

Deleted: 6

Deleted: ,

Deleted: 7

Deleted: 88

Deleted: 0

Deleted: calibration

Deleted: 1

Deleted: calibration

Deleted: 2

Deleted: 3

to 20 per cent was observed. JWG discussed if the impactors as well as the vehicles would really be comparable as the test results presented were generated during a period of several years (2009 - 2011), during which the impactors and the vehicles may have undergone some changes.

196. The Concept Tech GmbH presented information on the influence of friction in the test device used for inverse testing. Further information from the different laboratories investigated their own test apparatus was shown. Based on the presentations and the conclusions, the IWG agreed on the limit for the friction of test devices for inverse testing.

(h) Evaluation of reproducibility and repeatability

197. The IWG started an international round robin vehicle test programme in September 2012. The vehicle testing was finalised by March 2013. Results were presented by test houses from Europe, Republic of Korea and USA. Apart from minor issues, the results of the different test houses showed a stable performance of the legform impactors with a good repeatability. Problems in durability did not occur during vehicle testing. During the vehicle tests at BAST, the lower test results with the FlexPLI with the final build level (named "master legs" during the process of establishing certification corridors) compared with the test results with former prototype flexible legform impactors, but tested with the same cars, led to discussions about the threshold values for the impactor. However, OICA showed an example for test results with the FlexPLI against a test rig, where the output values were not lower than the results during the tests with the former flexible legform impactors. The IWG finally agreed to keep the limit values for the impactor unchanged.

(i) Performance / injury criteria and threshold values

198. JASIC introduced information on the performance and injury criteria for the FlexPLI (GTR9-1-05r1, GTR9-1-06r1). The validation of criteria for the tibia fracture and the medial collateral ligament (MCL) and anterior cruciate ligament (ACL) failure was presented in detail and compared to the legform impactor currently used in grt No. 9. The results are mainly based on data from different sources of specimen testing and from which a probability function for the injury risk was developed. Performance limits for the tibia bending moment, the ACL and the MCL proposed by the Technical Evaluation Group (TEG) on FlexPLI were presented to participants.

199. The expert from USA raised some concerns regarding the injury thresholds that were chosen for the FlexPLI in relation to the EEVC legform impactor. With the ability of the flexible impactor it may be possible to achieve better protection with more stringent criteria. The USA does not see a necessity to just achieve a protection level that is comparable to the EEVC legform impactor. NHTSA will investigate this in more detail.

200. The IWG started discussion on the injury threshold values at its fifth meeting. The experts agreed on the injury criteria, but had an in-depth discussion on the threshold values for the different injury criteria and the injury probability that is chosen using risk curves. BAST proposed to lower the threshold values because of the FlexPLI with the final build level producing lower output values than the prototype legform impactors in inverse certification tests. This would also lead to difficulties in validating the original FlexPLI FE model against the FlexPLI prototype impactors that were used to establish the first dynamic certification corridors. BAST explained that it might be necessary to review all test results from former round robin test series prototype impactors. OICA was supportive of keeping the threshold values as proposed by the Technical Evaluation Group (TEG) on FlexPLI.

Deleted: GRSP

Deleted: 4

Deleted: 5

Deleted: some

Deleted: of vehicle tests

Deleted: 6

Deleted: criteria

Deleted: 7

Deleted: 198

201. At the sixth meeting of the IWG, OICA presented further test data obtained using their FlexPLI with the final build level used for the round robin testing. These tests showed higher output values than those measured with the three FlexPLI with the final build level during vehicle tests.

202. In addition to the discussion on the injury threshold values, the IWG also begun discussing the underlying injury risk functions. NHTSA requested information from which the proposed threshold values were derived, because the injury probability needs to be estimated for their cost-benefit analysis. At the Technical Evaluation Group (TEG) on FlexPLI, two different approaches to derive threshold values were used, one proposed by BAST and the other proposed by JASIC. Upon request from NHTSA, BAST and JASIC provided information on the derivation of the injury risk function using their own approaches (GTR9-6-08r1, GTR9-6-26). Since BAST used a direct correlation between the knee bending angle of the EEVC legform impactor and the MCL elongation of the FlexPLI to derive the threshold value for MCL failure, as well as the FlexPLI knee geometry to derive the threshold value for ACL/PCL failure, focus of the IWG discussion was given to the risk functions for tibia fracture.

203. From data on the peak human leg bending moment in dynamic 3-point lateral bending tests conducted by Nyquist et al., BAST used data for male subjects. Geometric data scaling was applied to the dataset using the standard length obtained from the German Industry Standard anthropometric database (DIN). As the used data was normally distributed according to the Shapiro Wilk Normality Test, the injury risk function for tibia fracture was derived from a normally distributed probability density function (GTR9-6-08r1).

204. JASIC chose to use both male and female data from the Nyquist study on the basis of past studies not showing significant difference in bone material property between males and females. In addition, JASIC also used more recently conducted leg 3-point bending test data from Kerrigan et al. The standard lengths taken from the anthropometric study by the University of Michigan Transportation Research Institute (UMTRI), which was also referred to when determining the legform dimensions, were used to geometrically scale the data. Since the peak moment data from the Nyquist study were attenuated by filtering, the survival model was applied to the dataset and the data from the Nyquist study were treated as right censored data, as opposed to the data from the Kerrigan study which were treated as uncensored (exact) data. Weibull distribution was assumed to allow asymmetric probability density distribution.

205. At the sixth meeting of the IWG, a comparison of both approaches carried out by BAST revealed that the calculated threshold values depend on various factors such as the underlying set of PMHS data, the scaling method, the particular anthropometrical database for human data scaling, the injury risk to be covered, and the statistical procedure used for the development of the injury risk function (GTR9-6-08r1). At the same meeting, JASIC presented a complete description of their approach by referring to the SAE technical paper already presented at the 2012 SAE World Congress (GTR9-6-26).

206. At the seventh meeting of the IWG, NHTSA preferred to recommend one single approach. JASIC, therefore, investigated and BAST contributed to further clarifications of their approaches by providing additional technical information to NHTSA (GTR9-7-07), but an effort to come up with one common proposal was not successful. Therefore, JASIC investigated the effect of each factor (human data sources, standard lengths for geometric data scaling, statistical procedure, etc.) on the injury risk function, so that any interested Contracting Party could refer to the

Deleted: 199

Deleted: with the same build level as the flexible legform impactors

Deleted: ("master legs")

Formatted: Strikethrough

Deleted: 0

Deleted: and NHTSA

Deleted: WG 17

Deleted: 1

Deleted: 2

Deleted: 3

Deleted: 4

provided information and determine its preferred approach. The information was shared by JASIC at the eighth meeting of the IWG (GTR9-8-11).

207. In the investigation done by JASIC, it was found that the choice of the standard length used to scale the human data is one of the most significant contributors to the injury risk functions. The dimensions of the EEVC legform impactor and the FlexPLI were determined from the anthropometric measurements for fiftieth percentile male conducted by the University of Michigan Transportation Research Institute (UMTRI). NHTSA pointed out at the eighth meeting that for any test dummy, the scaling of a risk curve (in theory) should be consistent with the actual anthropometry represented by the dummy. Accordingly, the legform injury risk scaling based on the fiftieth percentile UMTRI anthropometry would probably be the most accurate.

208. In previous work under the TEG, FlexPLI measurements were correlated with human injury risk with the aid of human body computer models and FlexPLI computer models. An injury transfer function was developed from the results of paired simulations of vehicle to pedestrian interactions. These simulations, which consisted of pedestrian leg or FlexPLI impacts into a series of simplified vehicle front-ends, provided a human vs. FlexPLI comparison under conditions that match actual gtr tests. BAST acknowledged the good correlation between the human FE model and the FlexPLI version GTR FE model of the final build level in terms of the tibia loadings; however, the knee correlation especially for the MCL elongation still shows potential for being further improved. The Alliance members indicated that the MCL response correlation between the two simulation models (FlexPLI & human body) would not be considered statistically significant ($R < 0.8$). Therefore, it is proposed that the threshold limits for the MCL based on this analysis should be used as a guide but should not be used as a pass fail criterion.

209. At the seventh meeting of the IWG, JASIC presented results that validated their FlexPLI FE model against the final build level of the actual FlexPLI (GTR9-7-08). The validation was based on the certification tests and corridors agreed to by the IWG. It was also shown that the injury threshold values derived using the transfer functions determined from the FlexPLI FE model were virtually the same as those proposed earlier by the TEG. BAST questioned how the original FlexPLI FE model could be validated against the FlexPLI prototype impactors – i.e. not the mass production model – that were used to establish the first dynamic certification corridors because of the master legs producing slightly different output values than the prototypes in inverse certification tests.

210. At the eighth meeting, the IWG agreed that the methodologies for establishing the injury risk curves should be stated for all Contracting Parties in the preamble of the gtr no. 9. In addition the injury threshold values proposed by the TEG should be incorporated into the document taking into account the text of the preamble, that for some Contracting Parties further studies may be necessary to evaluate the appropriateness of the thresholds for their domestic regions.

211. In order to meet the time line of Phase 2, the USA proposed at the ninth meeting of the IWG to include both the current injury threshold values in the gtr as well as the injury risk curves in the regulatory text of the gtr as contracting party options. The injury risk curves would be used by contracting parties selecting that option to determine the injury threshold values based on their domestic benefit assessment. The IWG deferred the discussion on this to GRSP to get all Contracting Parties involved in the discussion and the decision.

212. Contracting Parties agreed at the 54th session of GRSP to introduce flexibility for Contracting Parties regarding the injury threshold values but limit it to

Deleted: 5

Deleted: WG17

Deleted: 6

Deleted: At the seventh meeting of the IWG, JASIC presented results that validated their FlexPLI FE model against the final build level of the actual FlexPLI. The validation was based on the certification tests and corridors agreed to by the IWG. It was also shown that the injury threshold values derived using the transfer functions determined from the FlexPLI FE model were virtually the same as those proposed earlier by the TEG.

Deleted: [

Deleted:]

Deleted: 7

Deleted: 08

Deleted: 7

Deleted: are

Formatted: Font: Not Italic, Font color: Auto

Formatted: Font: Not Italic, Font color: Auto

Formatted: Font: Not Italic, Font color: Auto

Formatted: Font: Not Italic, Font color: Auto

Formatted: Font: Not Italic, Font color: Auto

Formatted: Font: Not Italic, Font color: Auto

Contracting Party without pre-existing pedestrian protection regulations or standards implemented in domestic legislation at the time the Phase 2 of Global Technical Regulation No.9. GRSP agreed to keep the data for injury risk curves as reference in the document table in section 7. As an example, for the tibia moment threshold, the injury risk curves can be found in document GTR9-1-06r1_A.

(j) Evaluation of vehicle countermeasures

213. During the fifth and sixth IWG meetings, information on the technical feasibility and possible vehicle countermeasures was provided by the experts from OICA, JASIC and NHTSA. OICA informed IWG that the feasibility may be a problem for some small volume products for which currently no detailed information on the performance with the FlexPLI was available.

214. Automakers from the USA explained that, for some heavier trucks and Sport Utility Vehicles (SUV), there would be a conflict between the customer requests for the US-market and the pedestrian bumper requirements. The IWG agreed that, for some markets, it may be necessary to further consider the scope of the gtr and to review, for specific vehicles, the lead time for the transposition of gtr No. 9 into regional or national law.

(k) Other items

Finite element models

215. The European Association of Automotive Suppliers (CLEPA) requested information on the development of finite element models for the FlexPLI. It was decided that the IWG would not develop such models but would serve as a platform for a regular exchange of information on this subject. This task was started at the second meeting of the IWG.

216. The expert from Humanetics informed participants about the status of work on developing a finite element model for the FlexPLI. Currently a model is available for purchase. The further development of the model is currently stopped and would be restarted as soon as the status of the impactor is final.

4. Key elements of the amendment

217. The key elements introduced by this amendment to the gtr No. 9 are:

- (a) the introduction of the flexible pedestrian legform impactor;
- (b) the introduction of new dynamic certification corridors;
- (c) the introduction of new static certification corridors;
- (d) the process of using an assessment interval for identifying maximum measurements.

5. Recommendations and Limitations for introducing the flexible lower legform impactor

218. At the sixth meeting of the IWG, the USA noted that while it would be in a position to agree with the injury risk curves within the timeline of the amendment 2 of this gtr, it may not be in a position to agree to injury risk values without delaying the timeline. The expert from USA suggested that, given that cost benefits may vary depending on the fleets of different countries, the gtr should include only the injury risk curves, with Contracting Parties choosing appropriate injury assessment reference values (IARVs) when implementing the gtr in national legislation.

Formatted: English (U.S.)

Deleted: 09

Deleted: 8

Deleted: 10

Deleted: 9

Deleted: 11

Deleted: 0

Deleted: 2

Deleted: 1

Deleted: 3

Deleted: 2

Deleted: 4

Deleted: 3

219. While the IWG rejected the suggestion of including only the injury risk curves, it is understood that the USA will conduct a full analysis of the impacts of the IARVs of the gtr. The USA will conduct fleet testing with the FlexPLI to evaluate the benefits. It would be also examined possible incremental improvements, such as the effect of lowering injury threshold values. These efforts could result in future recommendations to adjust the injury risk values and other aspects of this gtr.

220. As described in paragraphs 74 and 75, in some domestic regions introducing pedestrian safety requirements automobile manufacturers may find it challenging if offering a specific vehicle design. Therefore an adequate lead time during the transposition of the requirements of gtr No. 9 should be foreseen on the basis of cost-benefit data. This is indispensable especially for Contracting Parties without any requirements on pedestrian safety for vehicles and planning the introduction of pedestrian safety requirements.

221. Without obligation, it is recommended for Contracting Parties without requirements on pedestrian safety in their domestic law, to use the FlexPLI rather than the EEVC LFI during the transposition process due to its superior performance compared to the lower legform impactor of Phase 1 of the gtr No. 9.

222. The IWG noted that the simultaneous application of the EEVC legform impactor and the FlexPLI in various regulative and consumer rating requirements worldwide can lead to market distortions and an unnecessary burden on manufacturers. Therefore it is recommended that Contracting Parties implement this amendment for compliance at the earliest possible date as an option at the choice of the car manufacturer. However in those regions where there is existing legislation relating to legform testing with the EEVC legform impactor, vehicles fulfilling the requirements of Phase 1 of this legislation, already provide protection of the lower leg. Where this is the case, a review of costs and benefits of changing to the use of the FlexPLI may not be justified if it were to require a general redesign of existing vehicle types. Contracting Parties should consider exempting vehicles from meeting FlexPLI requirements when these vehicles were designed and proven to comply with the requirements for the EEVC LFI.

6. Task Force Bumper Test Area (TF-BTA)

223. On request of the expert from the European Commission a discussion on the current bumper test area, mostly for the lower legform impact, took place. The necessity of improving and notably widening the test area on the bumper for the lower legform test was shown as the area of the bumper is quite restricted as a result of angled front fascia designs and protrusions or other features on the fascia of some vehicles that interact with the 60 degree planes that in the current test procedure define the test area. The decision was to discuss the whole subject in detail in a specific task force on the bumper test area (TF-BTA).

224. The IWG agreed to establish such a task force. However it was also agreed that, depending on the progress of the task force, at a later stage it may be needed to separate the discussion on this subject from that on the FlexPLI. The bumper test area task force would be part of the informal group but it should also not restrict the progress on the FlexPLI as the main subject of the group. The expert of the European Commission chaired the task force's discussions.

225. A first web meeting of the task force took place on 4 September 2012; a work plan and an action list were adopted. The task force was expected to forward, if possible, a proposal to update the lower legform test procedure within the gtr No. 9 to

Deleted: 5

Deleted: 4

Deleted: 16

Deleted: 5... [...s described in (... [36]

Deleted: 17

Deleted: 6... [...ithout an ...b (... [37]

Deleted: [

Deleted: 18

Deleted: protection

Deleted: Contracting Party should consider exempting vehicles from meeting FlexPLI requirement when vVehicles were designed and proven to comply with the requirements for the EEVC LFI should therefore be exempted from meeting the FlexPLI requirements in all markets.

Formatted: Strikethrough

Deleted:]

Deleted: [Section 6 to be completed on the basis of current progress and status of work.]

Deleted: 19

Deleted: 7... . On request of the (... [38]

Deleted: 0

Deleted: 8... . The IWG agreed (... [39]

Deleted: 1

Deleted: 9

the IWG. This would improve the procedure for the lower legform test. The TF-BTA will assess all available and provided information.

226. The European Commission sought guidance on this topic by commissioning a contractor to investigate the different issues. First results of this work showed that, for the newer vehicles, the test area for the lower legform impact was narrowed. The contractor therefore was requested to further investigate possibilities to solve this issue, in cooperation with stakeholders.

227. In three further meetings from December 2012 to September 2013 first research results were presented, confirming that there is a need to test outside the currently defined narrow test area. However, it was also recognised that tests outside the current bumper test area, could lead to other issues which need to be assessed and addressed, if necessary. Notably, the reliability of the test results needs further investigation. Therefore, the issue will be further considered, along with all relevant assessment, to determine if and how the current and new pedestrian lower legform impactors (EEVC LFI, FlexPLI) can be used to test outside the currently defined bumper corners.

228. It was also recognized that TF-BTA will likely not finalise the necessary assessments, in line with the schedule of the IWG concerning the introduction of the FlexPLI and will therefore submit a separate proposal in due course.

7. List of documents discussed in the IWG on gtr No. 9 – Phase 2

Doc. No.	Re v	Name
GTR9-C-01	1	Agenda of the Constitutional Meeting of the Informal Group on GTR No 9 - Phase 2 (IG GTR9-PH2)
GTR9-C-02	1	Minutes of the Constitutional Meeting of the Informal Group on Global Technical Regulation No. 9 – Phase 2 (IG GTR9-PH2)
GTR9-C-03		Informal document GRSP-49-38: Draft terms of reference for the informal group on pedestrian safety phase 2 (IG PS2)
GTR9-C-04	1	History of Development of the FlexPLI
GTR9-C-05		Review of the FlexPLI TEG Activities
GTR9-C-06		Comments on the Draft Terms of Reference for the Informal Group on Pedestrian Safety Phase 2 (28/10/2011)
GTR9-C-07	1	Final Operating Principles and Terms of Reference for the IG GTR9-PH2
GTR9-C-08		TEG document matrix
GTR9-1-01	1	Agenda for the 1st meeting of the Informal Group on Global Technical Regulation No. 9 - Phase 2 (IG GTR9-PH2)
GTR9-1-02	1	Minutes of the 1st meeting of the Informal Group on Global Technical Regulation No. 9 - Phase 2 (IG GTR9-PH2)
GTR9-1-03	1	Document TF-RUCC-K-03-Rev.1: Work plan of Task Force Review and Update of Certification Corridors (TF-RUCC)
GTR9-1-04		FlexPLI Version GTR Prototype SN-02 - Durability Assessment

Deleted: 2

Deleted: 0

Deleted: also

Deleted: 3

Deleted:

Deleted: but

Deleted: s

Deleted: problems and that

Deleted: would

Deleted: is

Deleted: and an

Deleted: would be planned,

Deleted: P

Deleted: 4

Deleted: Unfortunately, i

Deleted: finally

Deleted: cannot finish

Deleted: ir work

Deleted: time to meet

Deleted: will need to be separated to finalise their work. The expert of the European Commission will undertake the necessary steps

GTR9-1-05	1	Technical Discussion – Biofidelity
GTR9-1-06	1	Technical Discussion – Injury Criteria
GTR9-1-07	1	Technical Discussion – Benefit
GTR9-1-08	1	FlexPLI GTR Status, 1 – 2 December 2011
GTR9-1-09		Informal document WP.29-155-35: Report to the November session of WP.29 on the activities of the IG GTR9-PH2
GTR9-1-10		Changes to Flex PLI GTR Since Prototype Build, Status Dec. 2010
GTR9-1-11		Scatter of pendulum test results, 09.11.2010
GTR9-1-12		Informal document GRSP-49-23: Update on Pedestrian Leg Testing
GTR9-2-01	1	Agenda for the 2nd meeting of the Informal Group on Global Technical Regulation No. 9 - Phase 2 (IG GTR9-PH2) - Final
GTR9-2-02	1	Minutes of the 2nd meeting of the Informal Group on Global Technical Regulation No. 9 – Phase 2 (IG GTR9-PH2) - Final
GTR9-2-03		Proposal for a Modification of the Bumper Test Area for Lower and Upper Legform to Bumper Tests
GTR9-2-04	1	Robustness of SN02 prototype test results - Revision 1
GTR9-2-05		Comparison of Filter Classes for FlexPLI
GTR9-2-06		Technical Specification and PADI
GTR9-2-07	1	Technical Discussion – Benefit (Update of document GTR9-1-07 Rev. 1)
GTR9-2-08		FlexPLI GTR meeting actions
GTR9-2-09		FlexPLI GTR – FE model v2.0
GTR9-2-10	2	FlexPLI Comparison - test experiences with different impactors (completed during the 3rd meeting)
GTR9-2-11		Informal document WP.29-156-11: First progress report of the informal group on Phase 2 of gtr No. 9
GTR9-2-12		Re-examination of Number of Pedestrians by Injury Severity
GTR9-2-13		FLEX PLI Update for Alliance of Automobile Manufacturers
GTR9-2-14		Updated Japan Progress Report: Review and Update Certification Test Corridors and Test Methods (added pendulum Test data)
GTR9-3-01	1	Agenda for the 3rd meeting of the Informal Group on Global Technical Regulation No. 9 - Phase 2 (IG GTR9-PH2) - Final
GTR9-3-02	1	Minutes of the 3rd meeting of the Informal Group on Global Technical Regulation No. 9 - Phase 2 (IG GTR9-PH2) – Final
GTR9-3-03		Informal document GRSP-51-15: Draft second progress report of the informal group on Phase 2 of UN GTR No. 9 (IG GTR9 - PH2)
GTR9-3-04		Flex PLI GTR User Manual Rev. C
GTR9-3-05		FlexPLI Prototype SN04 Robustness Test results
GTR9-3-06		Proposal for a future vehicle test matrix
GTR9-4-01	1	Agenda for the 4th meeting of the Informal Group on Global Technical Regulation No. 9 - Phase 2 (IG GTR9-PH2) - Final

GTR9-4-02	1	Minutes of the 4th meeting of the Informal Group on Global Technical Regulation No. 9 - Phase 2 (IG GTR9-PH2) - Final
GTR9-4-03	3	Status of activity list items
GTR9-4-04		1994 EEVC WG10 Report
GTR9-4-05		1996 EEVC WG10 report to the 15th ESV conference
GTR9-4-06		1998/2002 EEVC WG17 Report
GTR9-4-07		TF-RUCC Activity Report 6 Sept. 2012
GTR9-4-08		Guidelines To Conduct FlexPLI Round Robin Car Test Smoothly and Effectively
GTR9-4-09		FlexPLI Round Robin Test Results
GTR9-4-10		Informal document WP.29-157-16: Proposal for the establishment of Special Resolution No. 2 on description and performance of test tools and devices necessary for the assessment of compliance
GTR9-4-11		Investigation of the Influences of Friction within the Inverse Certification Test Setup
GTR9-4-12		Report addressing the Pedestrian Research performed by JASIC
GTR9-4-13		JP Research Summary: JASIC Flex Injury Estimate
GTR9-4-14		Comparison of FlexPLI Performance in Vehicle Tests with Prototype and Series Production Legforms
GTR9-4-15		Informal document WP.29-157-21: Second progress report of the informal group on Phase 2 of gtr No. 9 (IG GTR9 - PH2)
GTR9-4-16	1	Pedestrian Lower Extremity Injury Risk - Revision 1
GTR9-4-17		FlexPLI Round Robin Car Test Schedule
GTR9-4-18		FlexPLI vs. EEVC LFI Benefit Estimation
GTR9-4-19		Overview of NHTSA Pedestrian Activities
GTR9-4-20		Validation of Pedestrian Lower Limb Injury Assessment using Subsystem Impactors (IRCOBI conference, 12th – 14th Sept. 2012)
GTR9-4-21		OSRP Pedestrian Lower Leg Response Research test series
GTR9-4-22		Checklist for Vehicle Testing
GTR9-5-01	1	Agenda for the 4th meeting of the Informal Group on Global Technical Regulation No. 9 - Phase 2 (IG GTR9-PH2) - Final
GTR9-5-02	1	Minutes of the 5th meeting of the Informal Group on Global Technical Regulation No. 9 – Phase 2 (IG GTR9-PH2) - Final
GTR9-5-03		Pedestrian Injuries By Source: Serious and Disabling Injuries in US and European Cases (Mallory et al. Paper for 56th AAAM Annual Conference)
GTR9-5-04		Flex PLI GTR User Manual Rev. D, Oct. 2012
GTR9-5-05	2	FlexPLI - Round Robin Tests
GTR9-5-06		Informal document WP29-158-28: Draft 3rd progress report
GTR9-5-07	c2	Discussion on Feasibility of FlexPLI Countermeasures
GTR9-5-08		Proposal for Procedure to Process FlexPLI Measurements in Rebound Phase
GTR9-5-09		Applicability Information

GTR9-5-10		FlexPLI Durability Against Larger Vehicles
GTR9-5-11		FlexPLI Repeatability in Car Tests
GTR9-5-12		Experimental Validation of Human and FlexPLI FE Models
GTR9-5-13		FlexPLI vs. EEVC LFI Correlation
GTR9-5-14		Benefit and Cost; Additional Analysis based on GTR9-2-07r1
GTR9-5-15		Moving Ram Friction Effect
GTR9-5-16	1	Round Robin Test Result (E-Leg)
GTR9-5-17		FlexPLI Test Results (SN-03)
GTR9-5-18		Flex PLI Logbook for the IG GTR9-PH2 Round Robin Tests
GTR9-5-19		Estimation of Cost Reduction due to Introduction of FlexPLI within GTR9
GTR9-5-20		Verification of Draft FlexPLI prototype impactor limits and application to FlexPLI serial production level
GTR9-5-21		US Round Robin Test Status
GTR9-5-22		Information on vehicle data used in NHTSA's studies
GTR9-5-23	c	Initial comments of OICA representatives to the 5th IG GTR9-PH2 meeting in response to document GTR9-5-20
GTR9-5-24		Height tolerance for pedestrian protection
GTR9-5-25		Flex PLI Inverse Test Setup - Moving Ram Friction
GTR9-5-26		Investigation of the Influences of Friction within the Inverse Certification Test Setup of the FlexPLI - Lower Legform Impactor
GTR9-5-27		Clarification of Injury Threshold Determination Process Used by JAMA
GTR9-5-28		Operating Principles and Terms of Reference for the IG GTR9-PH2, updated version 5th meeting
GTR9-5-29		Draft gtr No 9 amendment, version 2012-12-06
GTR9-5-30		Discussion of the Rebound Issue, ACEA comments
GTR9-5-31	1	FlexPLI version GTR drawing package
GTR9-6-01	1	Agenda for the 6th meeting of the Informal Group on Global Technical Regulation No. 9 – Phase 2 (IG GTR9-PH2) - Final
GTR9-6-02	2	Minutes of the 6th meeting of the Informal Group on Global Technical Regulation No. 9 – Phase 2 (IG GTR9-PH2) - Final
GTR9-6-03		FlexPLI Testing: Propelling Accuracy
GTR9-6-04		Guidelines for the development of drawings for a test tool to be added as an Addendum to UN Mutual Resolution No. 1 (M.R.1) - (ECE/TRANS/WP.29/1101)
GTR9-6-05		Schedule to prepare an Addendum for FlexPLI for the M.R.1
GTR9-6-06		FlexPLI GTR User Manual Rev. E 2013
GTR9-6-07		Definition of FlexPLI Biofidelic Assessment Interval
GTR9-6-08	1	Derivation of FlexPLI thresholds
GTR9-6-09		FlexPLI Drawings
GTR9-6-10		FlexPLI Pre- & Post-Test Procedure
GTR9-6-11		Consideration of the Rebound Phase

Formatted: French (France)

GTR9-6-12		Validation of Flex-GTR model
GTR9-6-13		Proposal for a wording to consider tolerances of the normal ride height
GTR9-6-14	1	FlexPLI Round Robin Testing
GTR9-6-15	1	Summary JPR Report Evaluating the Methodology and Assumptions Made in Doc. GTR9-5-14 and GTR9-5-19
GTR9-6-16		JPR Report Evaluating the Methodology and Assumptions Made in Doc. GTR9-5-14 and GTR9-5-19
GTR9-6-17		Large Truck/SUV Challenges
GTR9-6-18		FlexPLI Round Robin Test Results
GTR9-6-19	1	FlexPLI Round Robin Test Results
GTR9-6-20		Discussion on Impactor Thresholds
GTR9-6-21		Flex-PLI Rebound Issue: Industry Proposal (Update)
GTR9-6-22		FlexPLI Drawing Review (Surface Level)
GTR9-6-23	2	FlexPLI Drawings Review
GTR9-6-24		Durability Study SN-03
GTR9-6-25		Comments on GTR9-6-15 (JP Research review of JASIC & BAST FlexPLI Injury Reduction Estimate)
GTR9-6-26		Development of Injury Probability Functions for the Flexible Pedestrian Legform Impactor
GTR9-6-27		Comments on Alliance and JP Research Documents (GTR9-6-15 and GTR9-6-16)
GTR9-6-28		Certification test results of the OEM legform used in document GTR9-6-20
GTR9-7-01	1	Agenda for the 7th meeting of the Informal Group on Global Technical Regulation No. 9 – Phase 2 (IG GTR9-PH2) - Final
GTR9-7-02	1	Minutes of the 7th meeting of the Informal Group on Global Technical Regulation No. 9 – Phase 2 (IG GTR9-PH2) - Final
GTR9-7-03		Draft running order of the provisional agenda
GTR9-7-04		Information on drawing package kindly provided by Humanetics
GTR9-7-05	c	Result of drawing review (surface level)
GTR9-7-06	c	Result of manual review
GTR9-7-07		Injury Probability Function for Tibia Fracture and MCL Failure
GTR9-7-08		Development of Flex-GTR Master Leg FE Model and Evaluation of Validity of Current Threshold Values
GTR9-7-09		Flex-GTR Master Leg Level Impactor Test Data - Pendulum Test
GTR9-7-10		FlexPLI Logbook - legform SN-01
GTR9-7-11		FlexPLI Logbook - legform SN-03
GTR9-7-12		FlexPLI Logbook - legform E-Leg
GTR9-7-13		FlexPLI Rebound Phase
GTR9-7-14		Detailed Review of Drawing Package and Itemized Check against Master Leg Impactor SN03
GTR9-7-15		BAST comments on GTR9-7-13:JASIC position on FlexPLI rebound phase
GTR9-7-16	1	Collation of FlexPLI Pendulum Certification Test Results

Formatted: German (Germany)

GTR9-7-17	1	Collation of FlexPLI Inverse Certification Test Results
GTR9-8-01	1	Agenda for the 8th meeting of the Informal Group on Global Technical Regulation No. 9 – Phase 2 (IG GTR9-PH2) - Final
GTR9-8-02		Minutes of the 8th meeting of the Informal Group on Global Technical Regulation No. 9 – Phase 2 (IG GTR9-PH2) - Draft
GTR9-8-03	1	GTR9 – Draft Working Document of IG GTR9 PH2; Version 1, 04 Sept. 2013
GTR9-8-04		GTR9 – Draft Preamble of IG GTR9 PH2; Version 1, 04 Sept. 2014
GTR9-8-05		(not used)
GTR9-8-06		OICA comments on the draft text, based on document GRSP-53-29
GTR9-8-07		Proposed Title Block for Regulation Drawings
GTR9-8-08	1	Comments to JAMA presentation GTR9-7-06c and Proposed Changes, FlexPLI GTR Manual
GTR9-8-09		Comments to Cellbond Flex PLI Drawing Check Document GTR9-6-23
GTR9-8-10		Comments to JASIC's Comments Provided with Document GTR9-7-05c
GTR9-8-11		Comparison of Effect of Different Approaches on Injury Risk Functions
GTR9-8-12		Possible Influence of Temperature and Humidity on the FlexPLI Behavior
GTR9-8-13		FlexPLI Manual: FlexPLI Preparation before Car Testing
GTR9-8-14		Request for Transitional Provisions for FlexPLI Usage
GTR9-8-15		FlexPLI Biofidelic Assessment Interval (BAI): Open Issues
GTR9-8-16		Change to foam flesh used by EEVC lower & upper legforms
GTR9-8-17		FlexPLI Version GTR - Testing of Vehicles with Different Bumper Systems
GTR9-8-18		Femur Certification Corridors for the Inverse Test (Zero Cross Timing)
GTR9-8-19		Femur Certification Corridors for the Pendulum Test (Zero Cross Timing)
GTR9-9-01	1	Agenda for the 8th meeting of the Informal Group on Global Technical Regulation No. 9 – Phase 2 (IG GTR9-PH2) - Draft
GTR9-9-02		(Minutes of the 9th Meeting, not yet available)
GTR9-9-03		FlexPLI weight tolerances, Reduction of proposed weight tolerances
GTR9-9-04	1	Lower Legform Test Area, Justification of the Need for a Relaxation Zone
GTR9-9-05		Proposal of 01 series of amendments to Regulation No. 127: Transitional provisions
GTR9-9-06		Proposed amendments of the three-point bending certification test figure
GTR9-9-07	1	FlexPLI GTR User Manual Rev. F (Draft) 2013
GTR9-9-08	1	Updates to Flex PLI Manual Rev E to Rev F
GTR9-9-09		Max and Min Femur Certification Analysis FlexPLI
GTR9-9-10		FlexPLI Weight Tolerance Review
GTR9-9-11		Reviewed FlexPLI version GTR drawing package
GTR9-9-12		Details of Drawing Updates to Flex GTR9 Regulation Drawings
GTR9-9-13		Flesh Neoprene Corridor FlexPLI
GTR9-9-14		Dimensional Tolerance Review FlexPLI
GTR9-9-15		Confor Foam Change [for EEVC Impactors]

GTR9-9-16	Flex PLI Drawing Review
GTR9-9-17	Legform Tests, Results from Round 2, FlexPLI

Part B, Text of the Regulation, renumber as II and amend to read:

"II. Text of the Regulation

Insert new paragraphs 3.23. and 3.24., to read:

3.23. The assessment interval (AI) of the flexible lower legform impactor is defined and limited by the time of first contact of the flexible lower legform impactor with the vehicle and the timing of the last zero crossing of all femur and tibia segments after their first local maximum subsequent to any marginal value of 15 Nm, within their particular common zero crossing phases. The AI is identical for all bone segments and knee ligaments. In case of any bone segment not having a zero crossing during the common zero crossing phases, the time history curves for all bone segments are shifted downwards until all bending moments are crossing zero. The downwards shift is to be applied for the determination of the AI only.

3.24. "Primary reference marks" means holes, surfaces, marks and identification signs on the vehicle body. The type and the position of reference mark used and the vertical (Z) position of each mark relative to the ground shall be specified by the vehicle manufacturer according to the running conditions specified in paragraph 3.22. These marks shall be selected such as to be able to easily check the vehicle front and rear ride heights and vehicle attitude.

The primary reference marks shall be within ± 25 mm of the design position in the vertical (Z) axis. All tests are conducted with either the vehicle or all further measurements adjusted to simulate the vehicle being in the design position. This position shall be considered to be the normal ride attitude."

Paragraph 3.23. to 3.29., renumber as paragraphs 3.25 to 3.31.

Paragraph 5.1.1., amend to read:

5.1.1. When tested in accordance with paragraph 7.1.1. (flexible lower legform to bumper), the absolute value of the maximum dynamic medial collateral ligament elongation at the knee shall not exceed [22 mm], and the maximum dynamic anterior cruciate ligament and posterior cruciate ligament elongation shall not exceed [13 mm]. The absolute value of dynamic bending moments at the tibia shall not exceed [340 Nm]. In addition, the manufacturer may nominate bumper test widths up to a maximum of 264 mm in total where the absolute value of the tibia bending moment shall not exceed [380 Nm]. A Contracting Party may restrict application of the relaxation zone requirement in its domestic legislation if it decides that such restriction is appropriate.²

² A Contracting Party without pre-existing pedestrian protection regulations or standards implemented in domestic legislation at the time the Phase 2 of Global Technical Regulation No.9 is established in the Global Registry, may decide other injury thresholds for the maximum dynamic medial collateral ligament elongation, the maximum dynamic anterior cruciate ligament and posterior cruciate ligament elongation and the dynamic tibia bending moments in its domestic legislation if it decides that such modification is appropriate.]

Deleted: [

Deleted:]

Deleted: [

Deleted:]

Deleted: [

Deleted:]

Formatted: Justified, Indent: Left: 2 cm, Tab stops: 2 cm, Right + Not at 0 cm

When tested in accordance with paragraph 7.1.1. (lower legform to bumper), ~~the maximum dynamic knee bending angle shall not exceed 19°, the maximum dynamic knee shearing displacement shall not exceed 6.0 mm, and the acceleration measured at the upper end of the tibia shall not exceed 170g. In addition, the manufacturer may nominate bumper test widths up to a maximum of 264 mm in total where the acceleration measured at the upper end of the tibia shall not exceed 250g.~~"

Paragraphs 6.3.1.1. to 6.3.1.1.7.2., amend to read:

"6.3.1.1. **Flexible lower** ~~Lower~~ legform impactor:

The flexible lower legform impactor shall consist of the flesh and skin, the flexible long bone segments (representing the femur and the tibia), and the knee joint as shown in Figure 12.

The assembled length of the impactor shall be 928 mm, having a total mass of $13.2 \pm [0.4]$ kg]. When fully assembled in the impactor, the measurable lengths of the femur shall be 339 mm, of the knee joint shall be 185 mm and of the tibia shall be 404 mm. The knee joint centre position shall be 94 mm from the top of the knee joint at the vertical centre line of the knee.

Brackets, pulleys, protectors, connection parts, etc. attached to the impactor for the purposes of launching and/or protection may extend beyond the dimensions and tolerances shown in Figures 12 and 13.

~~The lower legform impactor shall consist of two foam covered rigid segments, representing femur (upper leg) and tibia (lower leg), joined by a deformable, simulated knee joint. The overall length of the impactor shall be 926 ± 5 mm, having a required test mass of 13.4 ± 0.2 kg (see Figure 12).~~

~~Brackets, pulleys, etc. attached to the impactor for the purpose of launching it, may extend the dimensions shown in Figure 12.~~

6.3.1.1.1. **The cross-sectional shape perpendicular to the Z-axis of the femur and the tibia main body segments shall be 90 mm in width along the Y-axis, and 84 mm in width along the X-axis as shown in Figure 13 (a). The impact face shall be 30 mm in radius, 30 mm in width along the Y-axis, and 48 mm in width along the X-axis as shown in Figure 13 (a).**

~~The diameter of the femur and tibia shall be 70 ± 1 mm and both shall be covered by foam flesh and skin. The foam flesh shall be 25 mm thick foam type CF-45 or equivalent. The skin shall be made of neoprene foam, faced with 0.5 mm thick nylon cloth on both sides, with an overall thickness of 6 mm.~~

6.3.1.1.2. **The cross-sectional shape perpendicular to the Z-axis of the knee joint shall be 108 mm in width along the Y-axis, and 118 mm in width along the X-axis as shown in Figure 13 (b). The impact face shall be 103 mm in radius, 12 mm in width along the Y-axis, and 86 mm in width along the X-axis as shown in Figure 13 (b).**

~~The knee joint shall be fitted with deformable knee elements from the same batch as those used in the certification tests.~~

6.3.1.1.3. **The masses of the femur and the tibia without the flesh and skin, including the connection parts to the knee joint, shall be 2.46 ± 0.12 kg**

and 2.64 ± 0.13 kg respectively. The mass of the knee joint without the flesh and skin shall be 4.28 ± 0.21 kg. The assembled mass of the femur, the knee joint and the tibia without the flesh and skin shall be $9.38 [\pm 0.3]$ kg.

The centres of gravity of the femur and tibia without the flesh and skin, including the connection parts to the knee joint, shall be 159 ± 8 mm and 202 ± 10 mm respectively from the top, but not including the connection part to the knee joint, of each part as shown in Figure 12. The centre of gravity of the knee joint shall be 92 ± 5 mm from the top of the knee joint as shown in Figure 12.

The moment of inertia of the femur and the tibia without the flesh and skin, including the connection parts inserted to the knee joint, about the X-axis through the respective centre of gravity shall be 0.0325 ± 0.0016 kgm² and 0.0467 ± 0.0023 kgm² respectively. The moment of inertia of the knee joint about the X-axis through the respective centre of gravity shall be 0.0180 ± 0.0009 kgm².

The total masses of the femur and tibia shall be 8.6 ± 0.1 kg and 4.8 ± 0.1 kg respectively, and the total mass of the impactor shall be 13.4 ± 0.2 kg. The centre of gravity of the femur and tibia shall be 217 ± 10 mm and 233 ± 10 mm from the centre of the knee respectively. The moment of inertia of the femur and tibia, about a horizontal axis through the respective centre of gravity and perpendicular to the direction of impact, shall be 0.127 ± 0.010 kgm² and 0.120 ± 0.010 kgm² respectively.

- 6.3.1.1.4. For each test, the impactor (femur, knee joint and tibia) shall be covered by the flesh and skin composed of synthetic rubber sheets (R1, R2) and neoprene sheets (N1F, N2F, N1T, N2T, N3) as shown in Figure 14. The size of the sheets shall be within the requirements described in Figure 15. The sheets are required to have compression characteristics as shown in Figure 15. The compression characteristics shall be checked using material from the same batch as the sheets used for the impactor flesh and skin.

For each test the impactor shall be fitted with new foam flesh cut from one of up to four consecutive sheets of foam type CF 45 flesh material or equivalent, produced from the same batch of manufacture (cut from one block or 'bun' of foam), provided that foam from one of these sheets was used in the dynamic certification test and the individual weights of these sheets are within ± 2 percent of the weight of the sheet used in the certification test.

- 6.3.1.1.5. All impactor components shall be stored for a sufficient period of time in a controlled storage area with a stabilized temperature of $20 \pm 4^\circ\text{C}$ prior to the impactor removal for testing. After removal from the storage, the impactor shall not be subjected to conditions other than those in the test area as defined in paragraph 6.1.1.

The test impactor or at least the foam flesh shall be stored during a period of at least four hours in a controlled storage area with a stabilized humidity of 35 percent \pm 15 percent and a stabilized temperature of $20 \pm 4^\circ\text{C}$ prior to impactor removal for calibration. After removal from the storage the impactor shall not be subjected to conditions other than those pertaining in the test area.

- 6.3.1.1.6. Lower legform instrumentation

- 6.3.1.1.6.1. **Four transducers shall be installed in the tibia to measure bending moments at locations within the tibia. The sensing locations of each of the transducers are as follows: tibia-1: 134 mm, tibia-2: 214 mm, tibia-3: 294 mm and tibia-4: 374 mm below the knee joint centre respectively as shown in Figure 16.**

Three transducers shall be installed in the femur to measure bending moments applied to the femur. The sensing locations of each of the transducers are as follows: femur-1: 137 mm, femur-2: 217 mm and femur-3: 297 mm above the knee joint centre, respectively, as shown in Figure 16.

The measurement axis of each transducer shall be the X-axis of the impactor.

~~A uniaxial accelerometer shall be mounted on the non impacted side of the tibia, 66 ± 5 mm below the knee joint centre, with its sensitive axis in the direction of impact.~~

- 6.3.1.1.6.2. **Three transducers shall be installed in the knee joint to measure elongations of the medial collateral ligament (MCL), anterior cruciate ligament (ACL), and posterior cruciate ligament (PCL). The measurement locations of each transducer are shown in Figure 16. The measurement locations shall be within ± 4 mm along the X-axis from the knee joint centre.**

~~A damper shall be fitted to the shear displacement system and may be mounted at any point on the rear face of the impactor or internally. The damper properties shall be such that the impactor meets both the static and dynamic shear displacement requirements and prevents excessive vibrations of the shear displacement system.~~

- 6.3.1.1.6.3. **The instrumentation response value channel frequency class (CFC), as defined in ISO 6487:2002, shall be 180 for all transducers. The CAC response values, as defined in ISO 6487:2002, shall be 30 mm for the knee ligament elongations and 400 Nm for the tibia and femur bending moments.**

~~Transducers shall be fitted to measure knee bending angle and knee shearing displacement.~~

- 6.3.1.1.6.4. **The determination of all flexible lower legform impactor peak tibia bending moments and ligament elongations shall be limited to the assessment interval (AI) as defined in paragraph 3.23.**

~~The instrumentation response value channel frequency class (CFC), as defined in ISO 6487:2002, shall be 180 for all transducers. The CAC response values, as defined in ISO 6487:2002, shall be 50° for the knee bending angle, 10 mm for the shearing displacement and 500g for the acceleration. This does not require that the impactor itself be able to physically bend and shear to these angles and displacements.~~

- 6.3.1.1.7. **Flexible lower legform impactor** Lower legform certification

- 6.3.1.1.7.1. The **flexible lower legform impactor** ~~lower legform~~ shall meet the performance requirements specified in paragraph 8.

- 6.3.1.1.7.2. **The impactor shall be certified using two certification tests as follows: First, the certification shall be conducted according to the inverse**

certification (IC) test procedure prescribed in paragraph 8.1.3 before starting a vehicle test series. Second, after a maximum of 10 vehicle tests, certification should be conducted according to the pendulum certification (PC) test procedure prescribed in paragraph 8.1.2. Ongoing certification testing then shall constitute the sequence IC – PC – PC – IC – PC – PC – etc. with a maximum of 10 tests between each certification.

In addition, the impactor shall be certified according to the procedures prescribed in paragraph 8.1. at least once a year.

~~The certified impactor may be used for a maximum of 10 impacts before re-certification. With each test new plastically deformable knee elements should be used. The impactor shall also be re-certified if more than one year has elapsed since the previous certification, if any impactor transducer output, in any impact, has exceeded the specified CAC or has reached the mechanical limits of the leg impactor deformation capability."~~

Figure 12, shall be deleted:

Insert new Figures 12 to 16, to read:

"Figure 12

Flexible lower legform impactor: Dimensions and centre of gravity locations of femur, knee joint and tibia (side view)

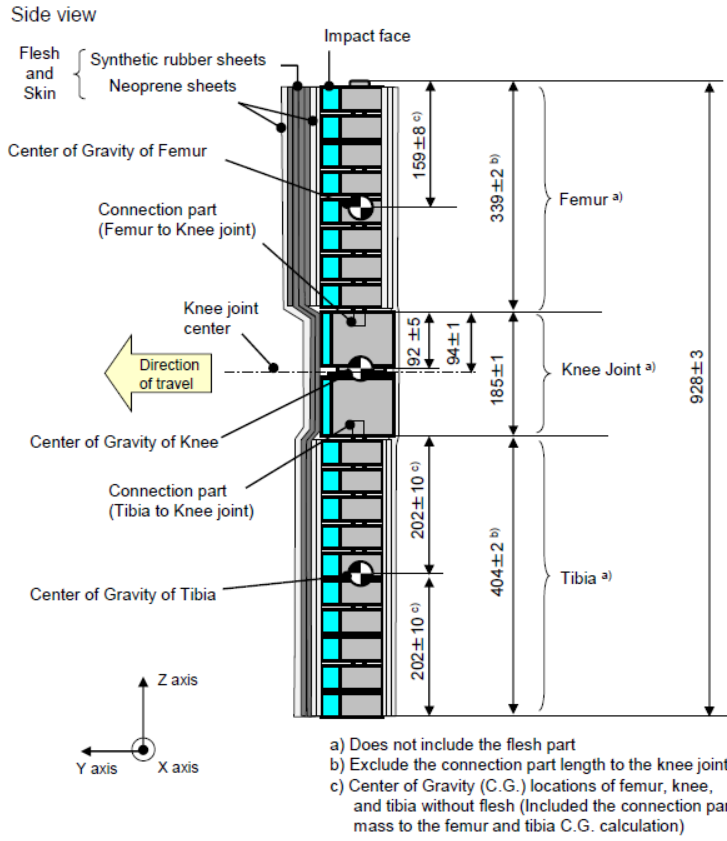

Figure 13
Flexible lower legform impactor: Schematic plan views of femur, tibia, and knee dimensions (top view)

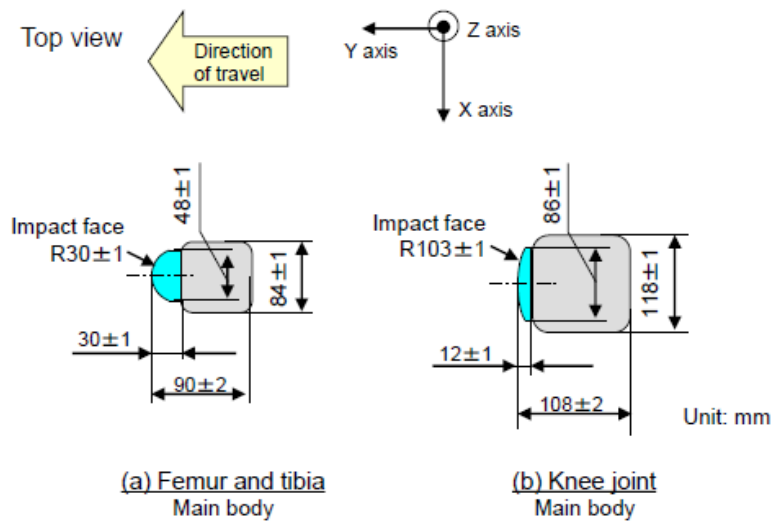

Figure 14
Flexible lower legform impactor: Flesh and skin dimensions

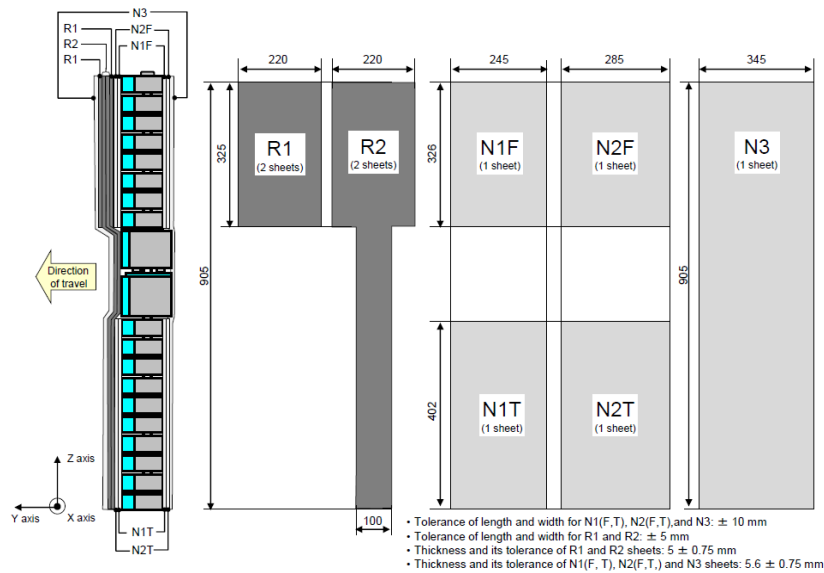
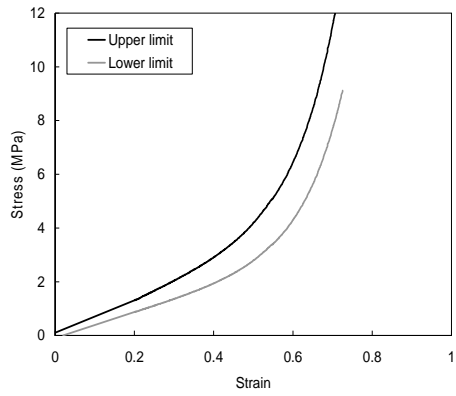

Figure 15
Flexible lower legform impactor: Flesh and skin compression characteristics

(a) Synthetic rubber sheets



(b) [Neoprene sheets]

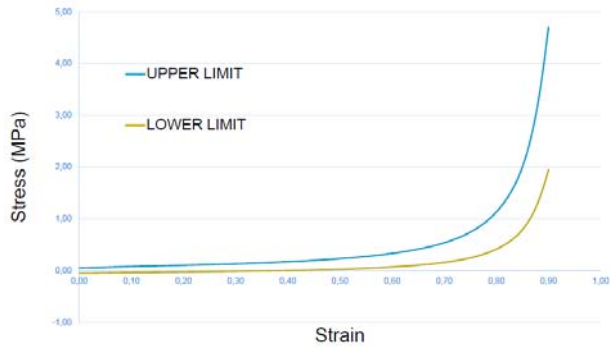
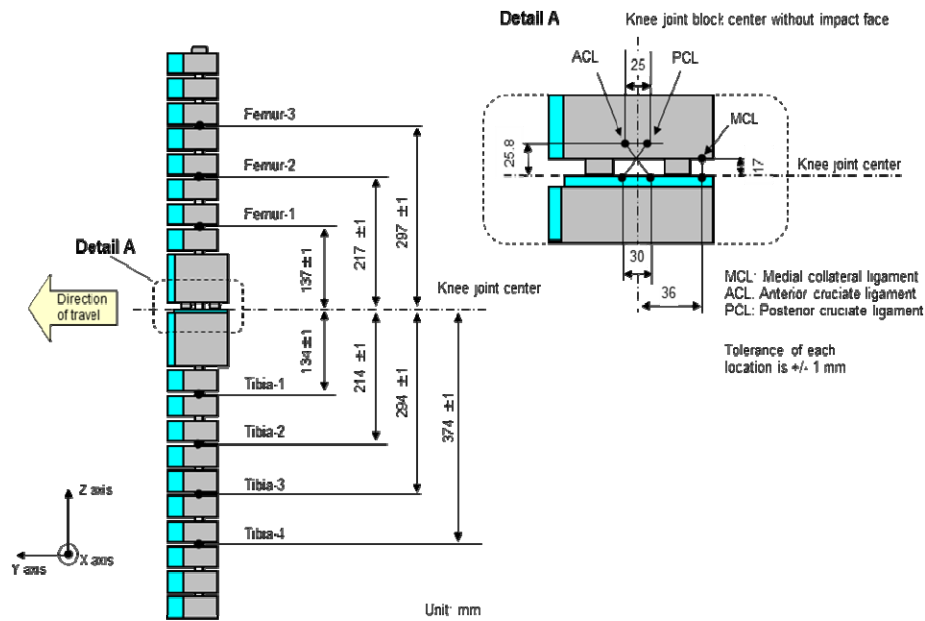

Figure 16
Flexible lower legform impactor; Instrument



Paragraph 6.3.1.2., amend to read:

"6.3.1.2. ..., foam covered at the impact side, and 350 ± 5 mm long (see Figure 4317)."

Paragraph 6.3.1.2.9.1., amend to read:

"6.3.1.2.9.1 ...in three positions, as shown in Figure 4317, each using a separate channel."

Paragraph 6.3.1.2.9.2., amend to read:

"6.3.1.2.9.2. ...at positions 50 mm either side of the centre line (see Figure 4317)."

Figure 13(former), renumber as Figure 17.

Paragraph 6.3.2.1., amend to read:

"6.3.2.1. Child headform impactor (see Figure 4418)

The child....."

Paragraph 6.3.2.1.1., amend to read:

"6.3.2.1.1. ... axis perpendicular to the mounting face A (see Figure 4418) and ..."

Figure 14 (former), renumber as Figure 18.

Paragraph 6.3.2.2., amend to read:

"6.3.2.2. Adult headform impactor (see Figure ~~4519~~)

The adult ... as shown in Figure ~~4519~~. The mass ..."

Figure 15 (former), renumber as Figure 19.

Paragraph 6.3.2.2.1., amend to read:

"6.3.2.2.1. ... axis perpendicular to the mounting face A (see Figure ~~4519~~) and ..."

Paragraphs 7.1.1. to 7.1.1.3.2., amend to read:

7.1.1. **Flexible lower legform impactor** ~~Lower legform~~ to bumper test procedure:

Each test shall be completed within two hours of when the impactor to be used is removed from the controlled storage area."

7.1.1.1. The selected target points shall be in the bumper test area.

7.1.1.2. **The direction of the impact velocity vector shall be in the horizontal plane and parallel to the longitudinal vertical plane of the vehicle. The tolerance for the direction of the velocity vector in the horizontal plane and in the longitudinal plane shall be $\pm 2^\circ$ at the time of first contact. The axis of the impactor shall be perpendicular to the horizontal plane, with a roll and pitch angle tolerance of $\pm 2^\circ$ in the lateral and longitudinal plane. The horizontal, longitudinal and lateral planes are orthogonal to each other (see Figure 20).**

~~The direction of the impact velocity vector shall be in the horizontal plane and parallel to the longitudinal vertical plane of the vehicle. The tolerance for the direction of the velocity vector in the horizontal plane and in the longitudinal plane shall be $\pm 2^\circ$ at the time of first contact. The axis of the impactor shall be perpendicular to the horizontal plane with a tolerance of $\pm 2^\circ$ in the lateral and longitudinal plane. The horizontal, longitudinal and lateral planes are orthogonal to each other (see Figure 16).~~

7.1.1.3. **The bottom of the impactor (without parts needed for the purposes of launching and/or protection) shall be 75 mm above the ground reference plane at the time of the first contact with the bumper (see Figure 21), with a tolerance of ± 10 mm. When setting the height of the propulsion system, an allowance must be made for the influence of gravity during the period of free flight of the impactor.**

~~The bottom of the impactor shall be at 25 mm above ground reference plane at the time of first contact with the bumper (see Figure 17), with a ± 10 mm tolerance. When setting the height of the propulsion system, an allowance must be made for the influence of gravity during the period of free flight of the impactor.~~

7.1.1.3.1. **The lower legform impactor for the bumper tests shall be in 'free flight' at the moment of impact. The impactor shall be released to free flight at such a distance from the vehicle that the test results are not influenced by contact of the impactor with the propulsion system during the rebound of the impactor.**

The impactor may be propelled by any means that can be shown to meet the requirements of the test.

The lower legform impactor for the bumper tests shall be in 'free flight' at the moment of impact. The impactor shall be released to free flight at such a distance from the vehicle that the test results are not influenced by contact of the impactor with the propulsion system during rebound of the impactor.

The impactor may be propelled by an air, spring or hydraulic gun, or by other means that can be shown to give the same result.

- 7.1.1.3.2. **At the time of first contact the impactor shall have the intended orientation about its vertical axis, for the correct operation of its knee joint, with a yaw angle tolerance of $\pm 5^\circ$ (see Figure 20).**

At the time of first contact the impactor shall have the intended orientation about its vertical axis, for the correct operation of its knee joint, with a tolerance of $\pm 5^\circ$ (see Figure 16)."

Figures 16 and 17(former), renumber as Figures 20 and 21 and amend to read:

"Figure 20

Tolerances of angles

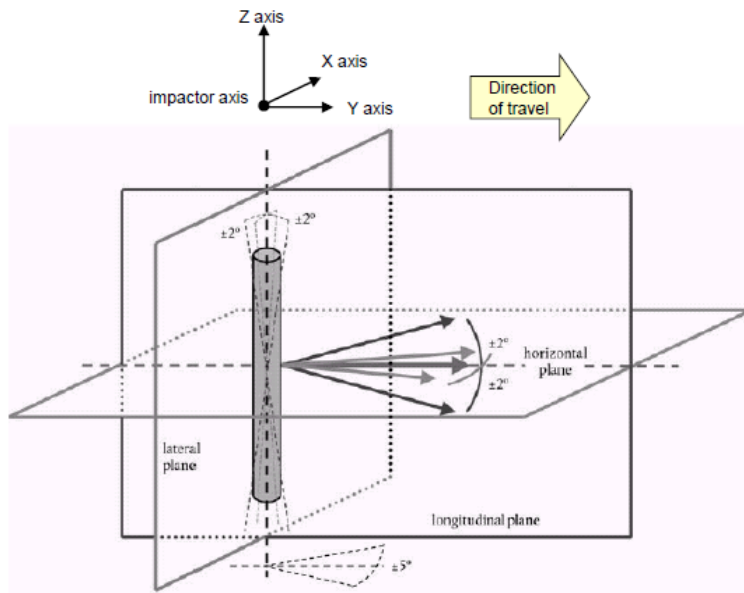
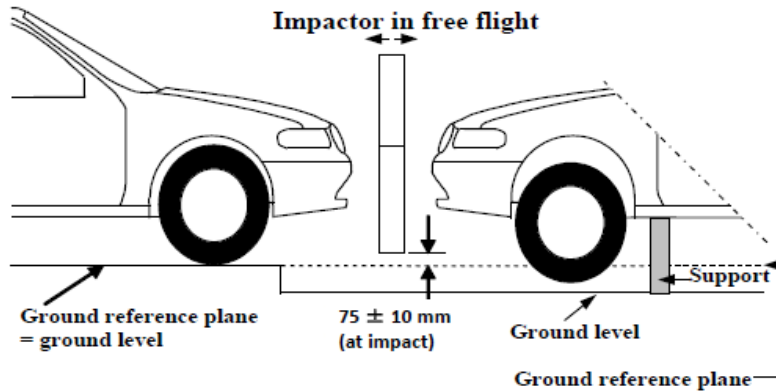

Figure 21

Flexible lower legform impactor Lower legform to bumper tests for complete vehicle in normal ride attitude (left) and for cut-body mounted on supports (right) (see paragraph 7.1.1.3.)



"

Insert new paragraphs 7.1.1.5. and 7.1.1.6., to read:

7.1.1.5 The tibia bending moments shall not exceed ± 15 Nm within an evaluation interval of 30 ms immediately prior to impact.

7.1.1.6 The offset compensation shall be done with the flexible lower legform impactor in resting position prior to the test / acceleration phase."

Paragraph 7.4.4., amend to read:

"7.4.4. The headform velocity at the time of impact shall be $\{9.7 \pm 0.2 \text{ m/s}\}$."

Paragraphs 8.1. to 8.1.2.4.2., amend to read:

8.1. Flexible lower legform impactor Lower-legform impactor certification

8.1.1. Static certification tests

8.1.1.1. The femur and the tibia of the flexible lower legform impactor shall meet the requirements specified in paragraph 8.1.1.2 when tested according to paragraph 8.1.1.4. The knee joint of the lower legform impactor shall meet the requirements specified in paragraph 8.1.1.3 when tested according to paragraph 8.1.1.5. The stabilized temperature of the impactor during the certification tests shall be $20^\circ \pm 2^\circ\text{C}$.

The CAC response values, as defined in ISO 6487:2002, shall be 30 mm for the knee ligament elongations and 4 kN for the applied external load. For these tests, low-pass filtering at an appropriate frequency is permitted to remove higher frequency noise without significantly affecting the measurement of the response of the impactor.

~~The lower legform impactor shall meet the requirements specified in paragraph 8.1.1.2. when tested as specified in paragraph 8.1.1.4. and the requirements specified in paragraph 8.1.1.3. when tested as specified in paragraph 8.1.1.5.~~

~~For both tests the impactor shall have the intended orientation about its longitudinal axis, for the correct operation of its knee joint, with a tolerance of $\pm 2^\circ$.~~

The stabilized temperature of the impactor during certification shall be $20^{\circ} \pm 2^{\circ}\text{C}$.

The CAC response values, as defined in ISO 6487:2002 shall be 50° for the knee bending angle and 500 N for the applied force when the impactor is loaded in bending in accordance with paragraph 8.1.1.4., and 10 mm for the shearing displacement and 10 kN for the applied force when the impactor is loaded in shearing in accordance with paragraph 8.1.1.5. For both tests low-pass filtering at an appropriate frequency is permitted, to remove higher frequency noise without significantly affecting the measurement of the response of the impactor.

- 8.1.1.2. **When the femur and the tibia of the impactor are loaded in bending in accordance with paragraph 8.1.1.4, the applied moment and the generated deflection at the centre of the femur and the tibia (M_c and D_c) shall be within the corridors shown in Figure 22.**

~~When the impactor is loaded in bending in accordance with paragraph 8.1.1.4., the applied force/bending angle response shall be within the limits shown in Figure 18. Also, the energy taken to generate 15.0° of bending shall be $100 \pm 7\text{J}$.~~

- 8.1.1.3. **When the knee joint of the impactor is loaded in bending in accordance with paragraph 8.1.1.5., the MCL, ACL, and PCL elongations and applied bending moment or the force at the centre of the knee joint (M_c or F_c) shall be within the corridors shown in Figure 23.**

~~When the impactor is loaded in shearing in accordance with paragraph 8.1.1.5., the applied force/shearing displacement response shall be within the limits shown in Figure 19.~~

- 8.1.1.4. **The edges of the femur and tibia, not bending parts, shall be mounted to the support rig firmly as shown in Figure 24 and Figure 25. The Y-axis of the impactor shall be parallel to the loading axis within $180 \pm 2^{\circ}$ tolerance. To obtain repeatable loading, low friction Polytetrafluoroethylene (PTFE) plastic pads are used under each support (see Figure 24 and Figure 25).**

The centre of the loading force shall be applied at the centre of the femur and the tibia within $\pm 2\text{mm}$ tolerance along the Z-axis. The force shall be increased so as to maintain a deflection rate between 10 and 100 mm/minute until the bending moment at the centre part (M_c) of the femur or tibia reaches 380 Nm.

~~The impactor, without foam covering and skin, shall be mounted with the tibia firmly clamped to a fixed horizontal surface and a metal tube connected firmly to the femur, as shown in Figure 20. The rotational axis of impactor knee joint shall be vertical. To avoid friction errors, no support shall be provided to the femur section or the metal tube. The bending moment applied at the centre of the knee joint, due to the mass of the metal tube and other components (excluding the legform itself), shall not exceed 25 Nm.~~

~~A horizontal normal force shall be applied to the metal tube at a distance of $2.0 \pm 0.01\text{m}$ from the centre of the knee joint and the resulting angle of knee deflection shall be recorded. The load shall be increased at a rate between 1.0 and $10^{\circ}/\text{s}$ until the angle of deflection of the knee is in excess of 22° . Brief excursions from these limits due, for instance, to the use of a hand pump shall be permitted.~~

The energy is calculated by integrating the force with respect to the bending angle in radians, and multiplying by the lever length of 2.0 ± 0.01 m.

- 8.1.1.5. **The ends of the knee joint shall be mounted to the support rig firmly as shown in Figure 26. The Y-axis of the impactor shall be parallel to the loading axis within $\pm 2^\circ$ tolerance. To obtain repeatable loading, low friction Polytetrafluoroethylene (PTFE) plastic pads are used under each support (see figure 26). To avoid impactor damage, a neoprene sheet shall be set underneath the loading ram and the impactor face of the knee joint which is described in the Figure 13 shall be removed. The neoprene sheet used in this test shall have compression characteristics as shown in Figure 15.**

The centre of the loading force shall be applied at the knee joint centre within $\pm 2^\circ$ mm tolerance along the Z-axis (see figure 12). The external load shall be increased so as to maintain a deflection rate between 10 and 100 mm/minute until the bending moment at the centre part of the knee joint (M_c) reaches 400 Nm.

~~The impactor, without foam covering and skin, shall be mounted with the tibia firmly clamped to a fixed horizontal surface and a metal tube connected firmly to the femur and restrained at 2.0 m from the centre of the knee joint, as shown in Figure 21.~~

~~A horizontal normal force shall be applied to the femur at a distance of 50 mm from the centre of the knee joint and the resulting knee shearing displacement shall be recorded. The load shall be increased between 0.1 and 20 mm/s until the shearing displacement of the knee is in excess of 7.0 mm or the load is in excess of 6.0 kN. Brief excursions from these limits due, for instance, to the use of a hand pump shall be permitted.~~

- 8.1.2. **Dynamic certification tests (pendulum test)**

- 8.1.2.1. ~~The assembled flexible lower legform impactor lower legform impactor shall meet the requirements according to paragraph 8.1.2.3 when tested as specified in paragraph 8.1.2.4.~~

- 8.1.2.2. Certification

- 8.1.2.2.1. **The test facility used for the certification test shall have a stabilized temperature of $20 \pm 2^\circ\text{C}$ during the test.**

~~The foam flesh for the test impactor shall be stored during a period of at least four hours in a controlled storage area with a stabilized humidity of 35 ± 10 percent and a stabilized temperature of $20 \pm 2^\circ\text{C}$ prior to impactor removal for calibration. The test impactor itself shall have a temperature of $20^\circ \pm 2^\circ\text{C}$ at the time of impact. The temperature tolerances for the test impactor shall apply at a relative humidity of 40 ± 30 percent after a soak period of at least four hours prior to their application in a test.~~

- 8.1.2.2.2. **The temperature of the certification area shall be measured at the time of certification and recorded in a certification report.**

~~The test facility used for the calibration test shall have a stabilized humidity of 40 ± 30 percent and a stabilized temperature of $20 \pm 4^\circ\text{C}$ during calibration.~~

- 8.1.2.2.3. ~~Each calibration shall be completed within two hours of when the impactor to be calibrated is removed from the controlled storage area.~~

~~8.1.2.2.4. Relative humidity and temperature of the calibration area shall be measured at the time of calibration and recorded in a calibration report.~~

8.1.2.3. Requirements

8.1.2.3.1. **When the flexible lower legform impactor is used for a test according to paragraph 8.1.2.4, the absolute value of the maximum bending moment of the tibia at tibia-1 shall be not more than 272 Nm and not less than 235 Nm, the absolute value of the maximum bending moment at tibia-2 shall be not more than 219 Nm and not less than 187 Nm, the absolute value of the maximum bending moment at tibia-3 shall be not more than 166 Nm and not less than 139 Nm, and the absolute value of the maximum bending moment at tibia-4 shall be not more than 111 Nm and not less than 90 Nm. The absolute value of the maximum elongation of MCL shall be not more than 24.0 mm and not less than 20.5 mm, the absolute value of the maximum elongation of ACL shall be not more than 10.5 mm and not less than 8.0 mm, and the absolute value of the maximum elongation of PCL shall be not more than 5.0 mm and not less than 3.5 mm.**

For all these values, the readings used shall be from the initial impact timing to 200 ms after the impact timing.

~~When the impactor is impacted by a linearly guided certification impactor, as specified in paragraph 8.1.2.4., the maximum upper tibia acceleration shall be not less than 120g and not more than 250g. The maximum bending angle shall be not less than 6.2° and not more than 8.2°. The maximum shearing displacement shall be not less than 3.5 mm and not more than 6.0 mm.~~

~~For all these values, the readings used shall be from the initial impact with the certification impactor and not from the arresting phase. Any system used to arrest the impactor or certification impactor shall be so arranged that the arresting phase does not overlap in time with the initial impact. The arresting system shall not cause the transducer outputs to exceed the specified CAC.~~

8.1.2.3.2. **The instrumentation response value CFC, as defined in ISO 6487:2002, shall be 180 for all transducers. The CAC response values, as defined in ISO 6487:2002, shall be 30 mm for the knee ligament elongations and 400 Nm for the tibia bending moments.**

~~The instrumentation response value CFC, as defined in ISO 6487:2002, shall be 180 for all transducers. The CAC response values, as defined in ISO 6487:2002, shall be 50° for the knee bending angle, 10 mm for the shearing displacement and 500g for the acceleration. This does not require that the impactor itself be able to physically bend and shear to these angles and displacements.~~

8.1.2.4. Test procedure

8.1.2.4.1. **The flexible lower legform impactor, including the flesh and skin, shall be suspended from the dynamic certification test rig $15 \pm 1^\circ$ upward from the horizontal as shown in Figure 27. The impactor shall be released from the suspended position and fall freely against the pin joint of the test rig as shown in Figure 27.**

~~The impactor, including foam covering and skin, shall be suspended horizontally by three wire ropes of 1.5 ± 0.2 mm diameter and of 2000 mm minimum length, as shown in Figure 22. It shall be suspended with its~~

~~longitudinal axis horizontal, with a tolerance of $\pm 0.5^\circ$, and perpendicular to the direction of the certification impactor motion, with a tolerance of $\pm 2^\circ$. The impactor shall have the intended orientation about its longitudinal axis, for the correct operation of its knee joint, with a tolerance of $\pm 2^\circ$. The impactor must meet the requirements of paragraph 6.3.1.1., with the attachment bracket(s) for the wire ropes fitted.~~

- 8.1.2.4.2. **The knee joint centre of the impactor shall be 30 ± 1 mm below the bottom line of the stopper bar, and the tibia impact face without the flesh and skin shall be located 13 ± 2 mm from the front upper edge of the stopper bar when the impactor is hanging freely as shown in Figure 27.**

~~The certification impactor shall have a mass of 9.0 ± 0.05 kg, this mass includes those propulsion and guidance components which are effectively part of the impactor during impact. The dimensions of the face of the certification impactor shall be as specified in Figure 23. The face of the certification impactor shall be made of aluminium, with an outer surface finish of better than 2.0 micrometers.~~

~~The guidance system shall be fitted with low friction guides, insensitive to off axis loading, that allow the impactor to move only in the specified direction of impact, when in contact with the vehicle. The guides shall prevent motion in other directions including rotation about any axis."~~

Paragraphs 8.1.2.4.3. to 8.1.2.4.5., shall be deleted

Insert new paragraphs 8.1.3. to 8.1.3.4.4. and new Figures 22 to 28, to read:

"8.1.3. Dynamic certification tests (inverse test)

- 8.1.3.1. The assembled flexible lower legform impactor shall meet the requirements according to paragraph 8.1.3.3. when tested as specified in paragraph 8.1.3.4.**

8.1.3.2. Certification

- 8.1.3.2.1. The test facility used for the certification test shall have a stabilized temperature of 20 ± 2 °C during certification.**

- 8.1.3.2.3. The temperature of the certification area shall be measured at the time of certification and recorded in a certification report.**

8.1.3.3. Requirements

- 8.1.3.3.1. When the flexible lower legform impactor is used for the test according to paragraph 8.1.3.4, the absolute value of the maximum bending moment of the tibia at tibia-1 shall be not more than 272 Nm and not less than 230 Nm, the absolute value of the maximum bending moment at tibia-2 shall be not more than 252 Nm and not less than 210 Nm, the absolute value of the maximum bending moment at tibia-3 shall be not more than 192 Nm and not less than 166 Nm, and the absolute value of the maximum bending moment at tibia-4 shall be not more than 108 Nm and not less than 93 Nm. The absolute value of the maximum elongations of the MCL shall be not more than 21.0 mm and not less than 17.0 mm, of the ACL shall be not more than 10.0 mm and not less than 8.0 mm and of the PCL shall be not more than 6.0 mm and not less than 4.0 mm.**

For all these values, the readings used shall be from the initial impact timing to 50 ms after the impact timing.

- 8.1.3.3.2. The instrumentation response value CFC, as defined in ISO 6487:2002, shall be 180 for all transducers. The CAC response values, as defined in ISO 6487:2002, shall be 30 mm for the knee ligament elongations and 400 Nm for the tibia bending moments.
- 8.1.3.4. Test procedure
- 8.1.3.4.1. The assembled flexible lower legform impactor (with the flesh and skin) shall be hung vertically and freely suspended from a test rig as shown in Figure 28. It is then impacted by the upper edge of a linearly guided aluminium honeycomb impactor, covered by a thin paper cloth with a maximum thickness of 1 mm, at an impact speed of 11.1 ± 0.2 m/s. The legform shall achieve a free flight condition within 10 ms after the time of first contact of the honeycomb impactor.
- 8.1.3.4.2. The honeycomb of 5052 alloy, which is attached in front of the moving ram, shall be 200 ± 5 mm wide, 160 ± 5 mm high and 60 ± 2 mm deep and shall have a crush strength of 75 psi ± 10 per cent. The honeycomb should have cell sizes of either 3/16 inch or 1/4 inch and a density of 2.0 pcf for the 3/16 inch cell size or a density of 2.3 pcf for the 1/4 inch cell size.
- 8.1.3.4.3. The upper edge of the honeycomb face shall be in line with the rigid plate of the linearly guided impactor. At the time of first contact, the upper edge of the honeycomb shall be in line with the knee joint centre line within a vertical tolerance of ± 2 mm. The honeycomb shall not be deformed before the impact test.
- 8.1.3.4.4. At the time of the first contact, the flexible lower legform impactor pitch angle (rotation around the Y-axis) and, therefore, the pitch angle of the velocity vector of the honeycomb impactor shall be within a tolerance of $\pm 2^\circ$ in relation to the lateral vertical plane. The flexible lower legform impactor roll angle (rotation around the X-axis) and, therefore, the roll angle of the honeycomb impactor shall be within a tolerance of $\pm 2^\circ$ in relation to the longitudinal vertical plane. The flexible lower legform impactor yaw angle (rotation around the Z-axis) and, therefore, the yaw angle of the velocity vector of the honeycomb impactor shall be within a tolerance of $\pm 2^\circ$.

Figure 22

Flexible lower legform impactor: Requirement corridors of the femur and the tibia in the static certification test (see paragraph 8.1.1.2.)

(a) Femur bending corridor

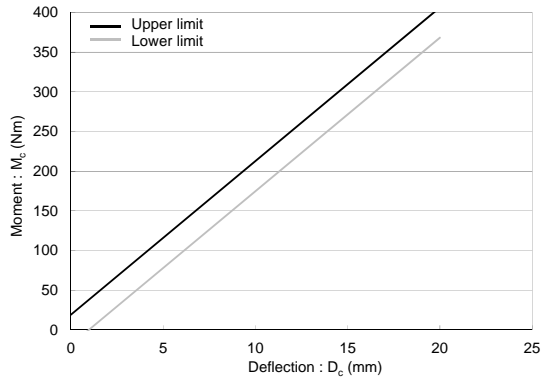

(b) Tibia bending corridor

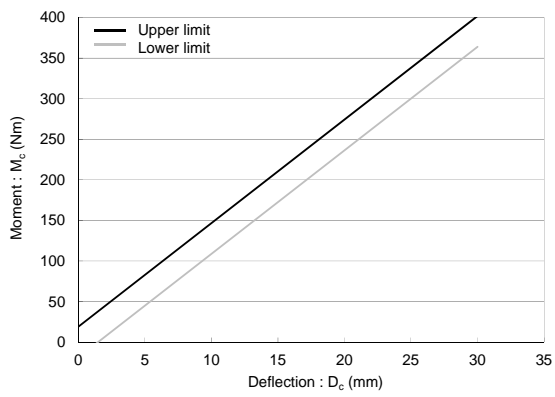
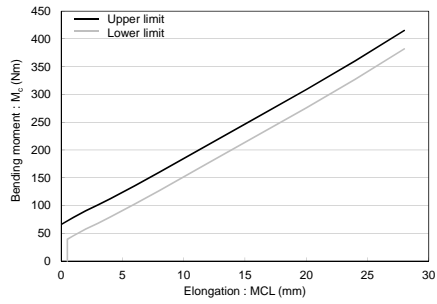
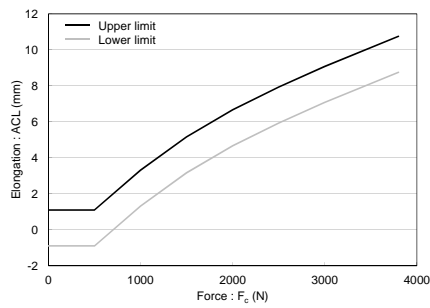

Figure 23
Flexible lower legform impactor: Requirement corridors for the knee joint in the static certification test (see paragraph 8.1.1.3.)



(a) for MCL



(b) for ACL

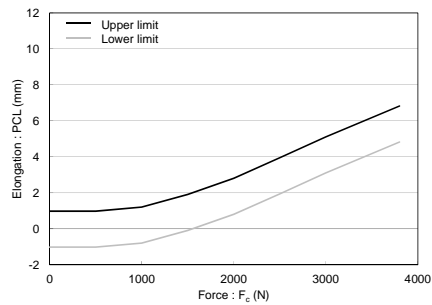

(c) for PCL

Figure 24
Flexible lower legform: Impactor test set-up for the femur in the static certification test (see paragraph 8.1.1.4.)

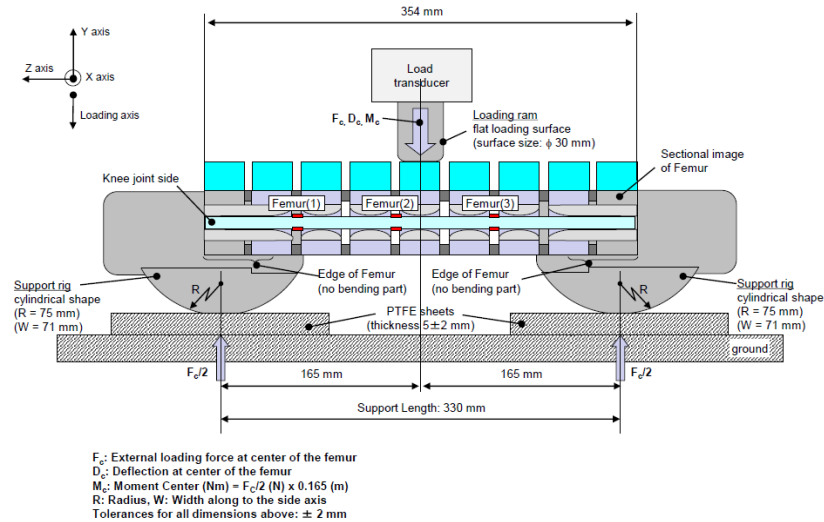

Figure 25
Flexible lower legform impactor: Test set-up for the tibia in the static certification test (see paragraph 8.1.1.4.)

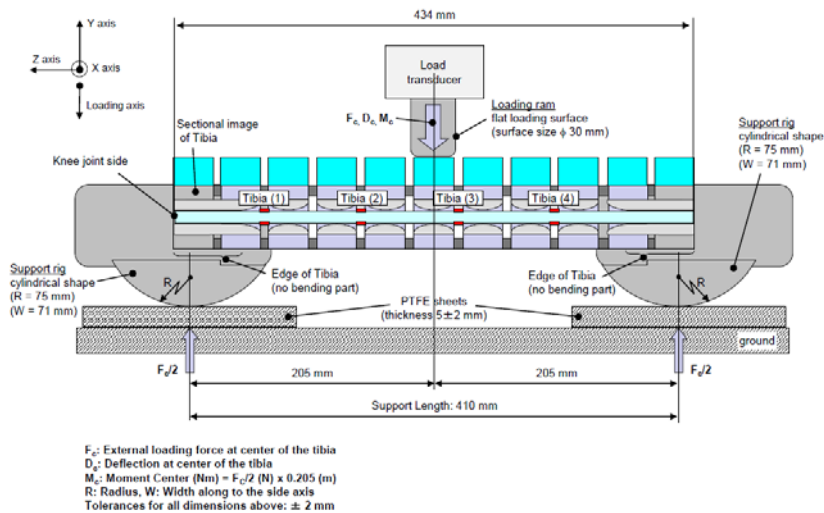

Figure 26
Flexible lower legform impactor: Test set-up for the knee joint in the static certification test (see paragraph 8.1.1.5.)

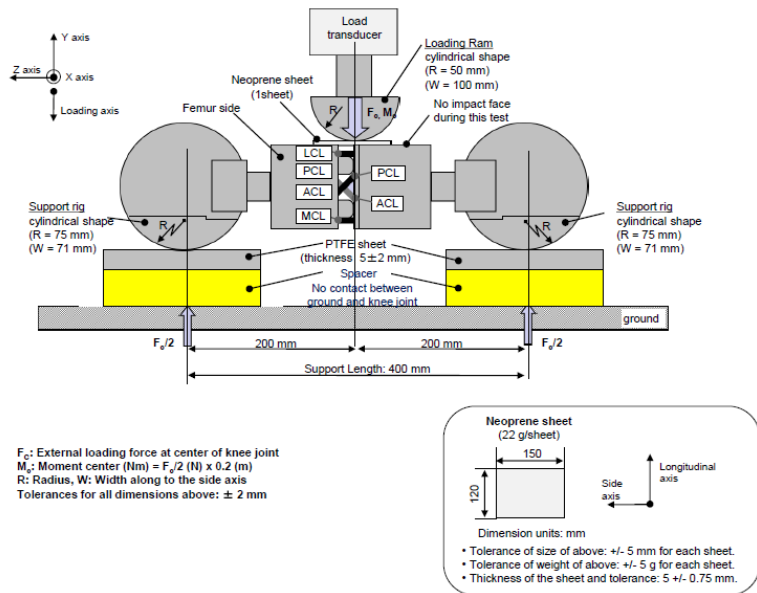

Figure 27
Flexible lower legform impactor: Test set-up for the dynamic lower legform impactor certification test (pendulum test, see paragraph 8.1.2.4.)

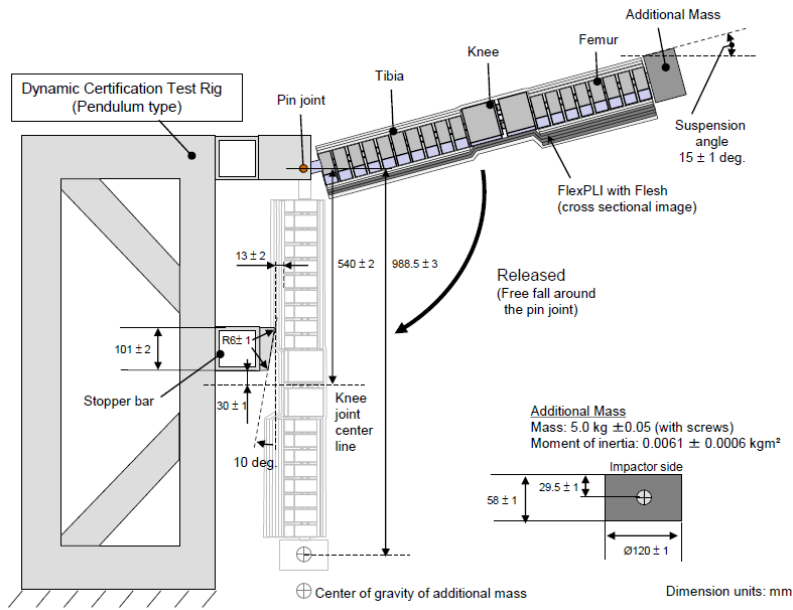
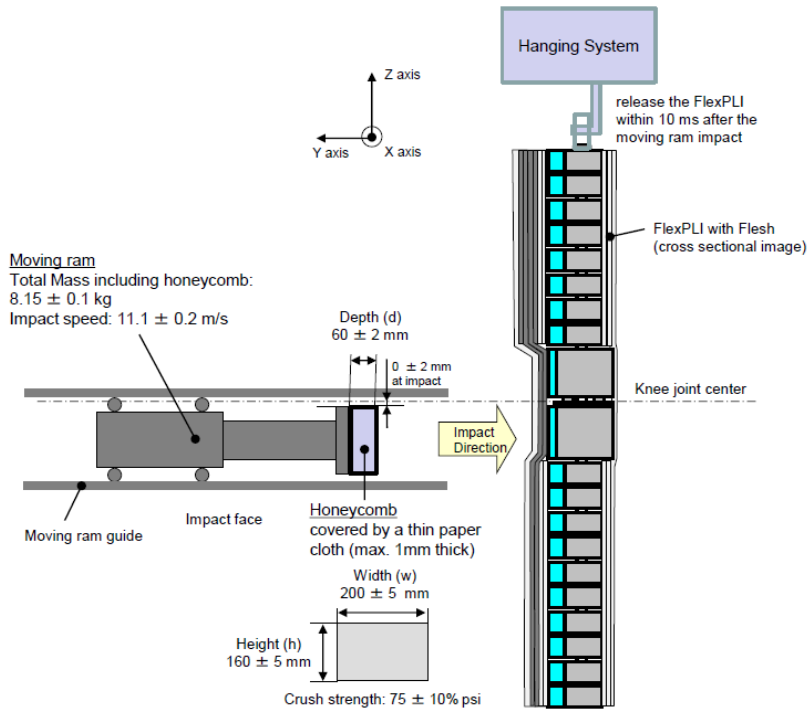

Figure 28
Flexible lower legform impactor: Test set-up for the dynamic lower legform impactor certification test (inverse test, see paragraph 8.1.3.4.)



"

Paragraph 8.2.4.6., amend to read:

"8.2.4.6. ... at a velocity of 7.1 ± 0.1 m/s into the stationary pendulum as shown in Figure 2429."

Paragraph 8.3.3.1., renumber as paragraph 8.4.3.1. and amend to read:

"8.3.3.1. ...impactor shall be suspended from a drop rig as shown in Figure 2530."

Paragraph 8.3.3.3., amend to read:

"8.3.3.3. ... impactor with respect to the vertical as shown in Figure 2530. The suspension of ..."

Figures 18 to 23 (former), shall be deleted

Figures 24 to 25 (former), renumber as Figures 29 to 30.

Page 5: [1] Deleted	Thomas Kinsky	17/12/2013 15:14:00
---------------------	---------------	---------------------

Proposed s

Page 5: [1] Deleted	Thomas Kinsky	17/12/2013 15:14:00
---------------------	---------------	---------------------

Proposed s

Page 5: [2] Deleted	Thomas Kinsky	17/12/2013 15:18:00
---------------------	---------------	---------------------

US-

Page 5: [2] Deleted	Thomas Kinsky	17/12/2013 15:18:00
---------------------	---------------	---------------------

US-

Page 5: [3] Deleted	Thomas Kinsky	17/12/2013 15:19:00
---------------------	---------------	---------------------

T

Page 5: [3] Deleted	Thomas Kinsky	17/12/2013 15:19:00
---------------------	---------------	---------------------

T

Page 5: [4] Deleted	Thomas Kinsky	17/12/2013 15:33:00
---------------------	---------------	---------------------

p

Page 5: [4] Deleted	Thomas Kinsky	17/12/2013 15:33:00
---------------------	---------------	---------------------

p

Page 5: [4] Deleted	Thomas Kinsky	17/12/2013 15:33:00
---------------------	---------------	---------------------

p

Page 5: [4] Deleted	Thomas Kinsky	17/12/2013 15:33:00
---------------------	---------------	---------------------

p

Page 5: [4] Deleted	Thomas Kinsky	17/12/2013 15:33:00
---------------------	---------------	---------------------

p

Page 5: [5] Deleted	Thomas Kinsky	17/12/2013 15:30:00
---------------------	---------------	---------------------

n

Page 5: [5] Deleted	Thomas Kinsky	17/12/2013 15:30:00
---------------------	---------------	---------------------

n

Page 5: [6] Deleted	Thomas Kinsky	17/12/2013 15:27:00
---------------------	---------------	---------------------

IHRA/PS/270

Page 5: [6] Deleted	Thomas Kinsky	17/12/2013 15:27:00
---------------------	---------------	---------------------

IHRA/PS/270

Page 5: [7] Deleted	Thomas Kinsky	16/12/2013 17:51:00
---------------------	---------------	---------------------

t

Page 5: [7] Deleted	Thomas Kinsky	16/12/2013 17:51:00
---------------------	---------------	---------------------

t

Page 5: [7] Deleted	Thomas Kinsky	16/12/2013 17:51:00
---------------------	---------------	---------------------

t

Page 5: [7] Deleted	Thomas Kinsky	16/12/2013 17:51:00
t		
Page 5: [8] Deleted	Thomas Kinsky	16/12/2013 17:43:00
Page 5: [8] Deleted	Thomas Kinsky	16/12/2013 17:43:00
Page 5: [8] Deleted	Thomas Kinsky	16/12/2013 17:43:00
Page 5: [9] Deleted	Thomas Kinsky	12/12/2013 15:23:00
ACEA		
Page 5: [9] Deleted	Thomas Kinsky	12/12/2013 15:23:00
ACEA		
Page 5: [9] Deleted	Thomas Kinsky	12/12/2013 15:23:00
ACEA		
Page 5: [10] Deleted	Thomas Kinsky	12/12/2013 15:22:00
ACEA e		
Page 5: [10] Deleted	Thomas Kinsky	12/12/2013 15:22:00
ACEA e		
Page 5: [10] Deleted	Thomas Kinsky	12/12/2013 15:22:00
ACEA e		
Page 5: [10] Deleted	Thomas Kinsky	12/12/2013 15:22:00
ACEA e		
Page 6: [11] Deleted	Thomas Kinsky	12/12/2013 15:13:00
document on active bonnet testing		
Page 6: [12] Deleted	Thomas Kinsky	12/12/2013 14:18:00
Lower leg research for developing corridors		
Page 6: [13] Deleted	Thomas Kinsky	12/12/2013 14:18:00
proposal for FlexPLI answering item 9 of PS/83		
Page 6: [14] Deleted	Thomas Kinsky	12/12/2013 14:16:00
NHTSA proposal for guidelines of preamble		
Page 6: [15] Deleted	Thomas Kinsky	12/12/2013 14:16:00
JAMA information on high bumper definition		
Page 6: [16] Deleted	Thomas Kinsky	12/12/2013 14:13:00
Chairman proposal for FlexPLI and rigid impactor use in gtr		
Page 6: [17] Deleted	Thomas Kinsky	12/12/2013 14:04:00
Preamble and draft gtr off doc for GRSP 37		

Page 6: [18] Deleted	Thomas Kinsky	12/12/2013 13:48:00
ISO Activities for Pedestrian Safety		
Page 7: [19] Deleted	Thomas Kinsky	12/12/2013 13:35:00
standard		
Page 7: [19] Deleted	Thomas Kinsky	12/12/2013 13:35:00
standard		
Page 7: [19] Deleted	Thomas Kinsky	12/12/2013 13:35:00
standard		
Page 7: [20] Deleted	Thomas Kinsky	12/12/2013 13:27:00
gtr testing and what it means for the		
Page 7: [20] Deleted	Thomas Kinsky	12/12/2013 13:27:00
gtr testing and what it means for the		
Page 7: [21] Deleted	Thomas Kinsky	12/12/2013 13:22:00
Proposal to solve the und		
Page 7: [21] Deleted	Thomas Kinsky	12/12/2013 13:22:00
Proposal to solve the und		
Page 7: [21] Deleted	Thomas Kinsky	12/12/2013 13:22:00
Proposal to solve the und		
Page 7: [22] Deleted	Thomas Kinsky	12/12/2013 13:25:00
Concerns on §7.4 with		
Page 7: [22] Deleted	Thomas Kinsky	12/12/2013 13:25:00
Concerns on §7.4 with		
Page 7: [22] Deleted	Thomas Kinsky	12/12/2013 13:25:00
Concerns on §7.4 with		
Page 7: [22] Deleted	Thomas Kinsky	12/12/2013 13:25:00
Concerns on §7.4 with		
Page 7: [22] Deleted	Thomas Kinsky	12/12/2013 13:25:00
Concerns on §7.4 with		
Page 7: [22] Deleted	Thomas Kinsky	12/12/2013 13:25:00
Concerns on §7.4 with		
Page 7: [23] Deleted	Thomas Kinsky	12/12/2013 13:08:00
OICA proposal for a mass for the		
Page 7: [23] Deleted	Thomas Kinsky	12/12/2013 13:08:00
OICA proposal for a mass for the		
Page 7: [24] Deleted	Thomas Kinsky	12/12/2013 13:06:00
OICA proposal on d		

Page 7: [24] Deleted	Thomas Kinsky	12/12/2013 13:06:00
OICA proposal on d		
Page 7: [24] Deleted	Thomas Kinsky	12/12/2013 13:06:00
OICA proposal on d		
Page 7: [24] Deleted	Thomas Kinsky	12/12/2013 13:06:00
OICA proposal on d		
Page 7: [25] Deleted	Thomas Kinsky	12/12/2013 13:02:00
b		
Page 7: [25] Deleted	Thomas Kinsky	12/12/2013 13:02:00
b		
Page 7: [26] Deleted	Thomas Kinsky	12/12/2013 13:01:00
Update of PS67 on c		
Page 7: [26] Deleted	Thomas Kinsky	12/12/2013 13:01:00
Update of PS67 on c		
Page 7: [26] Deleted	Thomas Kinsky	12/12/2013 13:01:00
Update of PS67 on c		
Page 7: [26] Deleted	Thomas Kinsky	12/12/2013 13:01:00
Update of PS67 on c		
Page 7: [27] Deleted	Thomas Kinsky	11/12/2013 16:37:00
h		
Page 7: [27] Deleted	Thomas Kinsky	11/12/2013 16:37:00
h		
Page 7: [27] Deleted	Thomas Kinsky	11/12/2013 16:37:00
h		
Page 7: [28] Deleted	Thomas Kinsky	11/12/2013 16:38:00
h		
Page 7: [28] Deleted	Thomas Kinsky	11/12/2013 16:38:00
h		
Page 7: [28] Deleted	Thomas Kinsky	11/12/2013 16:38:00
h		
Page 7: [28] Deleted	Thomas Kinsky	11/12/2013 16:38:00
h		
Page 7: [29] Deleted	Thomas Kinsky	11/12/2013 16:41:00
gtr		
Page 7: [29] Deleted	Thomas Kinsky	11/12/2013 16:41:00
gtr		

Page 7: [30] Deleted	Thomas Kinsky	11/12/2013 16:34:00
----------------------	---------------	---------------------

from

Page 7: [30] Deleted	Thomas Kinsky	11/12/2013 16:34:00
----------------------	---------------	---------------------

from

Page 7: [31] Deleted	Thomas Kinsky	11/12/2013 16:30:00
----------------------	---------------	---------------------

g

Page 7: [31] Deleted	Thomas Kinsky	11/12/2013 16:30:00
----------------------	---------------	---------------------

g

Page 7: [31] Deleted	Thomas Kinsky	11/12/2013 16:30:00
----------------------	---------------	---------------------

g

Page 7: [32] Deleted	Thomas Kinsky	11/12/2013 16:29:00
----------------------	---------------	---------------------

a

Page 7: [32] Deleted	Thomas Kinsky	11/12/2013 16:29:00
----------------------	---------------	---------------------

a

Page 7: [32] Deleted	Thomas Kinsky	11/12/2013 16:29:00
----------------------	---------------	---------------------

a

Page 7: [32] Deleted	Thomas Kinsky	11/12/2013 16:29:00
----------------------	---------------	---------------------

a

Page 7: [33] Deleted	Thomas Kinsky	11/12/2013 16:18:00
----------------------	---------------	---------------------

l

Page 7: [33] Deleted	Thomas Kinsky	11/12/2013 16:18:00
----------------------	---------------	---------------------

l

Page 7: [33] Deleted	Thomas Kinsky	11/12/2013 16:18:00
----------------------	---------------	---------------------

l

Page 7: [33] Deleted	Thomas Kinsky	11/12/2013 16:18:00
----------------------	---------------	---------------------

l

Page 7: [34] Deleted	Thomas Kinsky	11/12/2013 16:17:00
----------------------	---------------	---------------------

b

Page 7: [34] Deleted	Thomas Kinsky	11/12/2013 16:17:00
----------------------	---------------	---------------------

b

Page 7: [35] Deleted	Thomas Kinsky	11/12/2013 16:16:00
----------------------	---------------	---------------------

h

Page 7: [35] Deleted	Thomas Kinsky	11/12/2013 16:16:00
----------------------	---------------	---------------------

h

Page 7: [35] Deleted	Thomas Kinsky	11/12/2013 16:16:00
----------------------	---------------	---------------------

h

Page 21: [36] Deleted	Thomas Kinsky	10/12/2013 15:37:00
-----------------------	---------------	---------------------

5

Page 21: [36] Deleted	Thomas Kinsky	10/12/2013 15:37:00
-----------------------	---------------	---------------------

5

Page 21: [36] Deleted	Thomas Kinsky	10/12/2013 15:37:00
-----------------------	---------------	---------------------

5

Page 21: [36] Deleted	Thomas Kinsky	10/12/2013 15:37:00
-----------------------	---------------	---------------------

5

Page 21: [36] Deleted	Thomas Kinsky	10/12/2013 15:37:00
-----------------------	---------------	---------------------

5

Page 21: [36] Deleted	Thomas Kinsky	10/12/2013 15:37:00
-----------------------	---------------	---------------------

5

Page 21: [37] Deleted	Thomas Kinsky	10/12/2013 15:37:00
-----------------------	---------------	---------------------

6

Page 21: [37] Deleted	Thomas Kinsky	10/12/2013 15:37:00
-----------------------	---------------	---------------------

6

Page 21: [37] Deleted	Thomas Kinsky	10/12/2013 15:37:00
-----------------------	---------------	---------------------

6

Page 21: [37] Deleted	Thomas Kinsky	10/12/2013 15:37:00
-----------------------	---------------	---------------------

6

Page 21: [37] Deleted	Thomas Kinsky	10/12/2013 15:37:00
-----------------------	---------------	---------------------

6

Page 21: [37] Deleted	Thomas Kinsky	10/12/2013 15:37:00
-----------------------	---------------	---------------------

6

Page 21: [37] Deleted	Thomas Kinsky	10/12/2013 15:37:00
-----------------------	---------------	---------------------

6

Page 21: [37] Deleted	Thomas Kinsky	10/12/2013 15:37:00
-----------------------	---------------	---------------------

6

Page 21: [38] Deleted	Thomas Kinsky	10/12/2013 15:38:00
-----------------------	---------------	---------------------

7

Page 21: [38] Deleted	Thomas Kinsky	10/12/2013 15:38:00
-----------------------	---------------	---------------------

7

Page 21: [38] Deleted	Thomas Kinsky	10/12/2013 15:38:00
-----------------------	---------------	---------------------

7

Page 21: [38] Deleted	Thomas Kinsky	10/12/2013 15:38:00
-----------------------	---------------	---------------------

7

Page 21: [38] Deleted	Thomas Kinsky	10/12/2013 15:38:00
-----------------------	---------------	---------------------

7

Page 21: [38] Deleted	Thomas Kinsky	10/12/2013 15:38:00
-----------------------	---------------	---------------------

7

Page 21: [39] Deleted	Thomas Kinsky	10/12/2013 15:38:00
-----------------------	---------------	---------------------

8

Page 21: [39] Deleted	Thomas Kinsky	10/12/2013 15:38:00
-----------------------	---------------	---------------------

8

Page 21: [39] Deleted	Thomas Kinsky	10/12/2013 15:38:00
-----------------------	---------------	---------------------

8

Page 21: [39] Deleted	Thomas Kinsky	10/12/2013 15:38:00
-----------------------	---------------	---------------------

8

Page 21: [39] Deleted	Thomas Kinsky	10/12/2013 15:38:00
-----------------------	---------------	---------------------

8

Page 21: [39] Deleted	Thomas Kinsky	10/12/2013 15:38:00
-----------------------	---------------	---------------------

8

Page 21: [39] Deleted	Thomas Kinsky	10/12/2013 15:38:00
-----------------------	---------------	---------------------

8

Page 21: [39] Deleted	Thomas Kinsky	10/12/2013 15:38:00
-----------------------	---------------	---------------------

8

Page 21: [39] Deleted	Thomas Kinsky	10/12/2013 15:38:00
-----------------------	---------------	---------------------

8

Page 21: [39] Deleted	Thomas Kinsky	10/12/2013 15:38:00
-----------------------	---------------	---------------------

8