

PART 5

Consignment procedures

CHAPTER 5.1

GENERAL PROVISIONS

5.1.1 Application and general provisions

This Part sets forth the provisions for dangerous goods consignments relative to marking, labelling, and documentation, and, where appropriate, authorisation of consignments and advance notifications.

5.1.2 Use of overpacks

5.1.2.1 (a) An overpack shall be:

(i) marked with the word "OVERPACK"; and

(ii) marked with the UN number preceded by the letters "UN" as required for packages in 5.2.1.1 and 5.2.1.2, labelled as required for packages in 5.2.2 and marked with the environmentally hazardous substance mark if required for packages in 5.2.1.8, for each item of dangerous goods contained in the overpack;

unless the UN numbers, the labels and the environmentally hazardous substance mark representative of all dangerous goods contained in the overpack are visible, except as required in 5.2.2.1.11. If the same UN number, the same label or the environmentally hazardous substance mark is required for different packages, it only needs to be applied once.

The marking of the word "OVERPACK", which shall be readily visible and legible, shall be in an official language of the country of origin and also, if that language is not English, French or German, in English, French or German, unless agreements, if any, concluded between the countries concerned in the transport operation provide otherwise.

(b) Orientation arrows illustrated in 5.2.1.9 shall be displayed on two opposite sides of the following overpacks:

- overpacks containing packages which shall be marked in accordance with 5.2.1.9.1, unless the marking remains visible, and
- overpacks containing liquids in packages which need not be marked in accordance with 5.2.1.9.2, unless the closures remain visible.

5.1.2.2 Each package of dangerous goods contained in an overpack shall comply with all applicable provisions of ADN. The intended function of each package shall not be impaired by the overpack.

5.1.2.3 Each package bearing package orientation markings as prescribed in 5.2.1.9 and which is overpacked or placed in a large packaging shall be oriented in accordance with such markings.

5.1.2.4 The prohibitions on mixed loading also apply to these overpacks.

5.1.3 Empty uncleaned packagings (including IBCs and large packagings), tanks, MEMUs, vehicles, wagons and containers for carriage in bulk

5.1.3.1 Empty uncleaned packagings (including IBCs and large packagings), tanks (including tank-vehicles, tank-wagons, battery-vehicles, battery-wagons, demountable tanks, portable tanks, tank-containers, MEGCs, MEMUs), vehicles, wagons and containers for carriage in bulk having contained dangerous goods of the different classes other than Class 7, shall be marked and labelled as if they were full.

NOTE: For documentation, see Chapter 5.4.

5.1.3.2 Packagings, including IBCs and tanks, used for the carriage of radioactive material shall not be used for the storage or carriage of other goods unless decontaminated below the level of 0.4 Bq/cm² for beta and gamma emitters and low toxicity alpha emitters and 0.04 Bq/cm² for all other alpha emitters.

5.1.4 Mixed packing

When two or more dangerous goods are packed within the same outer packaging, the package shall be labelled and marked as required for each substance or article. If the same label is required for different goods, it only needs to be applied once.

5.1.5 General provisions for Class 7

5.1.5.1 Approval of shipments and notification

5.1.5.1.1 General

In addition to the approval for package designs described in Chapter 6.4 of ADR, multilateral shipment approval is also required in certain circumstances (5.1.5.1.2 and 5.1.5.1.3). In some circumstances it is also necessary to notify competent authorities of a shipment (5.1.5.1.4).

5.1.5.1.2 Shipment approvals

Multilateral approval shall be required for:

- (a) the shipment of Type B(M) packages not conforming with the requirements of 6.4.7.5 of ADR or designed to allow controlled intermittent venting;
- (b) the shipment of Type B(M) packages containing radioactive material with an activity greater than 3000 A₁ or 3000 A₂, as appropriate, or 1000 TBq, whichever is the lower;
- (c) the shipment of packages containing fissile materials if the sum of the criticality safety indexes of the packages in a single vessel, vehicle, wagon or container exceeds 50;

except that a competent authority may authorise carriage into or through its country without shipment approval, by a specific provision in its design approval (see 5.1.5.2.1).

5.1.5.1.3 Shipment approval by special arrangement

Provisions may be approved by a competent authority under which a consignment, which does not satisfy all of the applicable requirements of ADN may be carried under special arrangement (see 1.7.4).

5.1.5.1.4

Notifications

Notification to competent authorities is required as follows:

- (a) Before the first shipment of any package requiring competent authority approval, the consignor shall ensure that copies of each applicable competent authority certificate applying to that package design have been submitted to the competent authority of the country of origin of the shipment and to the competent authority of each country through or into which the consignment is to be carried. The consignor is not required to await an acknowledgement from the competent authority, nor is the competent authority required to make such acknowledgement of receipt of the certificate;
- (b) For each of the following types of shipments:
 - (i) Type C packages containing radioactive material with an activity greater than $3000 A_1$ or $3000 A_2$, as appropriate, or 1000 TBq, whichever is the lower;
 - (ii) Type B(U) packages containing radioactive material with an activity greater than $3000 A_1$ or $3000 A_2$, as appropriate, or 1000 TBq, whichever is the lower;
 - (iii) Type B(M) packages;
 - (iv) Shipment under special arrangement.

The consignor shall notify the competent authority of the country of origin of the shipment and the competent authority of each country through or into which the consignment is to be carried. This notification shall be in the hands of each competent authority prior to the commencement of the shipment, and preferably at least 7 days in advance;

- (c) The consignor is not required to send a separate notification if the required information has been included in the application for shipment approval;
- (d) The consignment notification shall include:
 - (i) sufficient information to enable the identification of the package or packages including all applicable certificate numbers and identification marks;
 - (ii) information on the date of shipment, the expected date of arrival and proposed routing;
 - (iii) the name(s) of the radioactive material(s) or nuclide(s);
 - (iv) descriptions of the physical and chemical forms of the radioactive material, or whether it is special form radioactive material or low dispersible radioactive material; and
 - (v) the maximum activity of the radioactive contents during carriage expressed in becquerels (Bq) with an appropriate SI prefix symbol (see 1.2.2.1). For fissile material, the mass of fissile material (or of each fissile nuclide for mixtures when appropriate) in grams (g), or multiples thereof, may be used in place of activity.

5.1.5.2 *Certificates issued by the competent authority*

5.1.5.2.1 Certificates issued by the competent authority are required for the following:

- (a) Designs for:
 - (i) special form radioactive material;
 - (ii) low dispersible radioactive material;
 - (iii) packages containing 0.1 kg or more of uranium hexafluoride;
 - (iv) all packages containing fissile material unless excepted by 6.4.11.2 of ADR;
 - (v) Type B(U) packages and Type B(M) packages;
 - (vi) Type C packages;
- (b) Special arrangements;
- (c) Certain shipments (see 5.1.5.1.2).

The certificates shall confirm that the applicable requirements are met, and for design approvals shall attribute to the design an identification mark.

The package design and shipment approval certificates may be combined into a single certificate.

Certificates and applications for these certificates shall be in accordance with the requirements in 6.4.23 of ADR.

5.1.5.2.2 The consignor shall be in possession of a copy of each applicable certificate.

5.1.5.2.3 For package designs where a competent authority issued certificate is not required, the consignor shall, on request, make available for inspection by the competent authority, documentary evidence of the compliance of the package design with all the applicable requirements.

5.1.5.3 *Determination of transport index (TI) and criticality safety index (CSI)*

5.1.5.3.1 The transport index (TI) for a package, overpack or container, or for unpackaged LSA-I or SCO-I, shall be the number derived in accordance with the following procedure:

- (a) Determine the maximum radiation level in units of millisieverts per hour (mSv/h) at a distance of 1 m from the external surfaces of the package, overpack, container, or unpackaged LSA-I and SCO-I. The value determined shall be multiplied by 100 and the resulting number is the transport index. For uranium and thorium ores and their concentrates, the maximum radiation level at any point 1 m from the external surface of the load may be taken as:

0.4 mSv/h	for ores and physical concentrates of uranium and thorium;
0.3 mSv/h	for chemical concentrates of thorium;
0.02 mSv/h	for chemical concentrates of uranium, other than uranium hexafluoride;

- (b) For tanks, containers and unpackaged LSA-I and SCO-I, the value determined in step (a) above shall be multiplied by the appropriate factor from Table 5.1.5.3.1;
- (c) The value obtained in steps (a) and (b) above shall be rounded up to the first decimal place (e.g. 1.13 becomes 1.2), except that a value of 0.05 or less may be considered as zero.

Table 5.1.5.3.1: Multiplication factors for tanks, containers and unpackaged LSA-I and SCO-I

Size of load ^a	Multiplication factor
size of load $\leq 1 \text{ m}^2$	1
$1 \text{ m}^2 < \text{size of load} \leq 5 \text{ m}^2$	2
$5 \text{ m}^2 < \text{size of load} \leq 20 \text{ m}^2$	3
$20 \text{ m}^2 < \text{size of load}$	10

^a *Largest cross-sectional area of the load being measured.*

- 5.1.5.3.2 The transport index for each overpack, vessel or cargo transport unit shall be determined as either the sum of the TIs of all the packages contained, or by direct measurement of radiation level, except in the case of non-rigid overpacks for which the transport index shall be determined only as the sum of the TIs of all the packages.
- 5.1.5.3.3 The criticality safety index for each overpack or container shall be determined as the sum of the CSIs of all the packages contained. The same procedure shall be followed for determining the total sum of the CSIs in a consignment or aboard a vessel or cargo transport unit.
- 5.1.5.3.4 Packages and overpacks shall be assigned to either category I-WHITE, II-YELLOW or III-YELLOW in accordance with the conditions specified in Table 5.1.5.3.4 and with the following requirements:
 - (a) For a package or overpack, both the transport index and the surface radiation level conditions shall be taken into account in determining which is the appropriate category. Where the transport index satisfies the condition for one category but the surface radiation level satisfies the condition for a different category, the package or overpack shall be assigned to the higher category. For this purpose, category I-WHITE shall be regarded as the lowest category;
 - (b) The transport index shall be determined following the procedures specified in 5.1.5.3.1 and 5.1.5.3.2;
 - (c) If the surface radiation level is greater than 2 mSv/h, the package or overpack shall be carried under exclusive use and under the provisions of 7.1.4.14.7.1.3 and 7.1.4.14.7.3.5 (a) as appropriate;
 - (d) A package carried under a special arrangement shall be assigned to category III-YELLOW except under the provisions of 5.1.5.3.5;
 - (e) An overpack which contains packages carried under special arrangement shall be assigned to category III-YELLOW except under the provisions of 5.1.5.3.5.
- 5.1.5.3.5 In all cases of international carriage of packages requiring competent authority design or shipment approval, for which different approval types apply in the different countries

concerned by the shipment, the categorization shall be in accordance with the certificate of the country of origin of design.

Table 5.1.5.3.4: Categories of packages and overpacks

Conditions		
Transport index	Maximum radiation level at any point on external surface	Category
0 ^a	Not more than 0.005 mSv/h	I-WHITE
More than 0 but not more than 1 ^a	More than 0.005 mSv/h but not more than 0.5 mSv/h	II-YELLOW
More than 1 but not more than 10	More than 0.5 mSv/h but not more than 2 mSv/h	III-YELLOW
More than 10	More than 2 mSv/h but not more than 10 mSv/h	III-YELLOW ^b

^a If the measured TI is not greater than 0.05, the value quoted may be zero in accordance with 5.1.5.3.1(c).

^b Shall also be carried under exclusive use.

5.1.5.4 *Specific provisions for excepted packages*

5.1.5.4.1 Excepted packages shall be legibly and durably marked on the outside of the packaging with:

- (a) The UN number preceded by the letters "UN";
- (b) An identification of either the consignor or consignee, or both; and
- (c) The permissible gross mass if this exceeds 50 kg.

5.1.5.4.2 The documentation requirements of Chapter 5.4 do not apply to excepted packages of radioactive material, except that the UN number preceded by the letters "UN" and the name and address of the consignor and the consignee shall be shown on a transport document such as a bill of lading, air waybill or CMR or CIM consignment note.

5.1.5.5 *Summary of approval and prior notification requirements*

NOTE 1: Before first shipment of any package requiring competent authority approval of the design, the consignor shall ensure that a copy of the approval certificate for that design has been submitted to the competent authority of each country en route (see 5.1.5.1.4 (a)).

NOTE 2: Notification required if contents exceed $3 \times 10^3 A_1$, or $3 \times 10^3 A_2$, or 1000 TBq (see 5.1.5.1.4 (b)).

NOTE 3: Multilateral approval of shipment required if contents exceed $3 \times 10^3 A_1$, or $3 \times 10^3 A_2$, or 1000 TBq, or if controlled intermittent venting is allowed (see 5.1.5.1).

NOTE 4: See approval and prior notification provisions for the applicable package for carrying this material.

Subject	UN Number	Competent authority approval required		Consignor required to notify the competent authorities of the country of origin and of the countries en route ^a before each shipment	Reference
		Country of origin	Countries en route ^a		
Calculation of unlisted A ₁ and A ₂ values	-	Yes	Yes	No	-
Excepted packages - package design - shipment	2908, 2909, 2910, 2911	No No	No No	No No	-
LSA material ^b and SCO ^b Industrial packages types 1, 2 or 3, non fissile and fissile excepted - package design - shipment	2912, 2913, 3321, 3322	No No	No No	No No	-
Type A packages, ^b non fissile and fissile excepted - package design - shipment	2915, 3332	No No	No No	No No	-
Type B(U) packages, ^b non fissile and fissile excepted - package design - shipment	2916	Yes No	No No	See Note 1 See Note 2	5.1.5.1.4 (b), 5.1.5.2.1 (a) 6.4.22.2 (ADR)
Type B(M) packages, ^b non fissile and fissile excepted - package design - shipment	2917	Yes See Note 3	Yes See Note 3	No Yes	5.1.5.1.4 (b), 5.1.5.2.1 (a), 5.1.5.1.2. 6.4.22.3 (ADR)
Type C packages, ^b non fissile and fissile excepted - package design - shipment	3323	Yes No	No No	See Note 1 See Note 2	5.1.5.1.4 (b), 5.1.5.2.1 (a) 6.4.22.2 of ADR

Subject	UN Number	Competent authority approval required		Consignor required to notify the competent authorities of the country of origin and of the countries en route ^a before each shipment	Reference
		Country of origin	Countries en route ^a		
Packages for fissile material - package design - shipment - sum of criticality safety indexes not more than 50 - sum of criticality safety indexes greater than 50	2977, 3324, 3325, 3326, 3327, 3328, 3329, 3330, 3331, 3333	Yes ^c	Yes ^c	No	5.1.5.2.1 (a), 5.1.5.1.2, 6.4.22.4 (ADR)
		No ^d	No ^d	See Note 2	
		Yes	Yes	See Note 2	
Special form radioactive material - design - shipment	- See Note 4	Yes See Note 4	No See Note 4	No See Note 4	1.6.6.3 (ADR), 5.1.5.2.1 (a) 6.4.22.5 (ADR)
Low dispersable radioactive material - design - shipment	- See Note 4	Yes See Note 4	No See Note 4	No See Note 4	5.1.5.2.1 (a), 6.4.22.5 (ADR)
Packages containing 0.1 kg or more of uranium hexafluoride - design - shipment	- See Note 4	Yes See Note 4	No See Note 4	No See Note 4	5.1.5.2.1 (a), 6.4.22.1 (ADR)
Special arrangement - shipment	2919, 3331	Yes	Yes	Yes	1.7.4.2, 5.1.5.2.1 (b), 5.1.5.1.4 (b)
Approved packages designs subjected to transitional measures	-	See 1.6.6	See 1.6.6	See Note 1	1.6.6.1, 1.6.6.2 (ADR), 5.1.5.1.4 (b), 5.1.5.2.1 (a), 5.1.5.1.2.

^a Countries from, through or into which the consignment is carried.

^b If the radioactive contents are fissile material which is not excepted from the provisions for packages containing fissile material, then the provisions for fissile material packages apply (see 6.4.11 of ADR).

^c Designs of packages for fissile material may also require approval in respect of one of the other items in the table.

^d Shipments may, however, require approval in respect of one of the other items in the table.

CHAPTER 5.2

MARKING AND LABELLING

5.2.1 Marking of packages

NOTE: For markings related to the construction, testing and approval of packagings, large packagings, pressure receptacles and IBCs, see Part 6 of ADR.

5.2.1.1 Unless provided otherwise in ADN, the UN number corresponding to the dangerous goods contained, preceded by the letters "UN" shall be clearly and durably marked on each package. The UN number and the letters "UN" shall be at least 12 mm high, except for packages of 30 litres capacity or less or of 30 kg maximum net mass and for cylinders of 60 litres water capacity or less, when they shall be at least 6 mm in height and except for packages of 5 litres or 5 kg or less when they shall be of an appropriate size. In the case of unpackaged articles the marking shall be displayed on the article, on its cradle or on its handling, storage or launching device.

5.2.1.2 All package markings required by this Chapter:

- (a) shall be readily visible and legible;
- (b) shall be able to withstand open weather exposure without a substantial reduction in effectiveness.

5.2.1.3 Salvage packagings and salvage pressure receptacles shall additionally be marked with the word "SALVAGE".

5.2.1.4 Intermediate bulk containers of more than 450 litres capacity and large packagings shall be marked on two opposite sides.

5.2.1.5 *Additional provisions for goods of Class 1*

For goods of Class 1, packages shall, in addition, bear the proper shipping name as determined in accordance with 3.1.2. The marking, which shall be clearly legible and indelible, shall be in an official language of the country of origin and also, if that language is not English, French or German, in English, French or German unless any agreements concluded between the countries concerned in the transport operation provide otherwise.

5.2.1.6 *Additional provisions for goods of Class 2*

Refillable receptacles shall bear the following particulars in clearly legible and durable characters:

- (a) the UN number and the proper shipping name of the gas or mixture of gases, as determined in accordance with 3.1.2.

In the case of gases classified under an N.O.S. entry, only the technical name¹ of the gas has to be indicated in addition to the UN number.

In the case of mixtures, not more than the two constituents which most predominantly contribute to the hazards have to be indicated;

- (b) for compressed gases filled by mass and for liquefied gases, either the maximum filling mass and the tare of the receptacle with fittings and accessories as fitted at the time of filling, or the gross mass;
- (c) the date (year) of the next periodic inspection.

These marks can either be engraved or indicated on a durable information disk or label attached on the receptacle or indicated by an adherent and clearly visible marking such as by printing or by any equivalent process.

NOTE 1: See also 6.2.2.7 of ADR.

NOTE 2: For non refillable receptacles, see 6.2.2.8 of ADR.

5.2.1.7 Special marking provisions for goods of Class 7

5.2.1.7.1 Each package shall be legibly and durably marked on the outside of the packaging with an identification of either the consignor or consignee, or both.

5.2.1.7.2 For each package, other than excepted packages, the UN number preceded by the letters "UN" and the proper shipping name shall be legibly and durably marked on the outside of the packaging. The marking of excepted packages shall be as required by 5.1.5.4.1.

5.2.1.7.3 Each package of gross mass exceeding 50 kg shall have its permissible gross mass legibly and durably marked on the outside of the packaging.

5.2.1.7.4 Each package which conforms to:

- (a) a Type IP-1 package, a Type IP-2 package or a Type IP-3 package design shall be legibly and durably marked on the outside of the packaging with "TYPE IP-1", "TYPE IP-2" or "TYPE IP-3" as appropriate;
- (b) a Type A package design shall be legibly and durably marked on the outside of the packaging with "TYPE A";
- (c) a Type IP-2 package, a Type IP-3 package or a Type A package design shall be legibly and durably marked on the outside of the packaging with the international

¹ Instead of the proper shipping name or, if applicable, of the proper shipping name of the n.o.s. entry followed by the technical name, the use of the following names is permitted:

- for UN No. 1078 refrigerant gas, n.o.s.: mixture F1, mixture F2, mixture F3;
- for UN No. 1060 methylacetylene and propadiene mixtures, stabilized: mixture P1, mixture P2;
- for UN No. 1965 hydrocarbon gas mixture, liquefied, n.o.s.: mixture A or butane, mixture A01 or butane, mixture A02 or butane, mixture A0 or butane, mixture A1, mixture B1, mixture B2, mixture B, mixture C or propane.
- for UN No. 1010 Butadienes, stabilized: 1,2-Butadiene, stabilized, 1,3-Butadiene, stabilized.

vehicle registration code (VRI Code)² of the country of origin of design and either the name of the manufacturer or other identification of the packaging specified by the competent authority of the country of origin of design.

5.2.1.7.5 Each package which conforms to a design approved by the competent authority shall be legibly and durably marked on the outside of the packaging with:

- (a) the identification mark allocated to that design by the competent authority;
- (b) a serial number to uniquely identify each packaging which conforms to that design;
- (c) in the case of a Type B(U) or Type B(M) package design, with “TYPE B(U)” or “TYPE B(M)”;
- (d) in the case of a Type C package design, with “TYPE C”.

5.2.1.7.6 Each package which conforms to a Type B(U), Type B(M) or Type C package design shall have the outside of the outermost receptacle which is resistant to the effects of fire and water plainly marked by embossing, stamping or other means resistant to the effects of fire and water with the trefoil symbol shown in the figure below.

Basic trefoil symbol with proportions based on a central circle of radius X. The minimum allowable size of X shall be 4 mm.

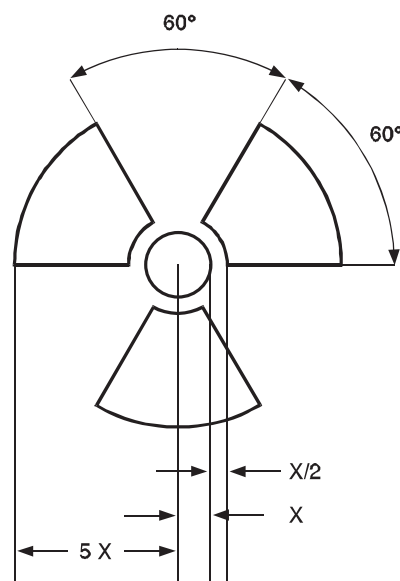

5.2.1.7.7 Where LSA-I or SCO-I material is contained in receptacles or wrapping materials and is carried under exclusive use as permitted by 4.1.9.2.3 of ADR, the outer surface of these receptacles or wrapping materials may bear the marking “RADIOACTIVE LSA-I” or “RADIOACTIVE SCO-I”, as appropriate.

5.2.1.7.8 In all cases of international carriage of packages requiring competent authority design or shipment approval, for which different approval types apply in the different countries concerned by the shipment, marking shall be in accordance with the certificate of the country of origin of the design.

² Distinguishing sign for motor vehicles in international traffic prescribed in the Vienna Convention on Road Traffic (1968).

5.2.1.8 *Special marking provisions for environmentally hazardous substances*

5.2.1.8.1 Packages containing environmentally hazardous substances meeting the criteria of 2.2.9.1.10 shall be durably marked with the environmentally hazardous substance mark shown in 5.2.1.8.3 with the exception of single packagings and combination packagings where such single packagings or inner packagings of such combination packagings have:

- a quantity of 5 l or less for liquids; or
- a net mass of 5 kg or less for solids.

5.2.1.8.2 The environmentally hazardous substance mark shall be located adjacent to the markings required by 5.2.1.1. The requirements of 5.2.1.2 and 5.2.1.4 shall be met.

5.2.1.8.3 The environmentally hazardous substance mark shall be as shown below. The dimensions shall be 100 mm × 100 mm, except in the case of packages of such dimensions that they can only bear smaller marks.



Symbol (fish and tree): black on white or suitable contrasting background

NOTE: The labelling provisions of 5.2.2 apply in addition to any requirement for packages to bear the environmentally hazardous substance mark.

5.2.1.9 *Orientation arrows*

5.2.1.9.1 Except as provided in 5.2.1.9.2:

- combination packagings having inner packagings containing liquids;
- single packagings fitted with vents; and
- cryogenic receptacles intended for the carriage of refrigerated liquefied gases,

shall be legibly marked with package orientation arrows which are similar to the illustration shown below or with those meeting the specifications of ISO 780:1997. The orientation arrows shall appear on two opposite vertical sides of the package with the arrows pointing in the correct upright direction. They shall be rectangular and of a size that is clearly visible commensurate with the size of the package. Depicting a rectangular border around the arrows is optional.

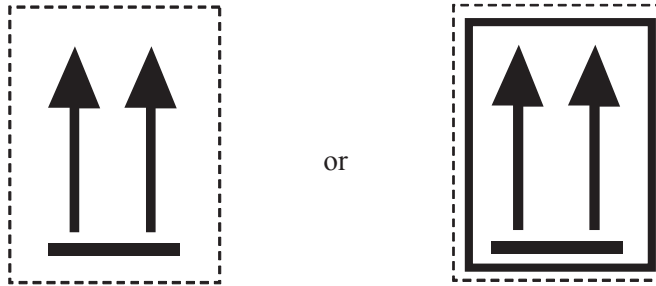

Two black or red arrows on white or suitable contrasting background.
The rectangular border is optional.

5.2.1.9.2

Orientation arrows are not required on:

- (a) Outer packagings containing pressure receptacles except cryogenic receptacles;
- (b) Outer packagings containing dangerous goods in inner packagings each containing not more than 120 ml, with sufficient absorbent material between the inner and outer packagings to completely absorb the liquid contents;
- (c) Outer packagings containing Class 6.2 infectious substances in primary receptacles each containing not more than 50 ml;
- (d) Type IP-2, type IP-3, type A, type B(U), type B(M) or type C packages containing Class 7 radioactive material;
- (e) Outer packagings containing articles which are leak-tight in all orientations (e.g. alcohol or mercury in thermometers, aerosols, etc.); or
- (f) Outer packagings containing dangerous goods in hermetically sealed inner packagings each containing not more than 500 ml.

5.2.1.9.3

Arrows for purposes other than indicating proper package orientation shall not be displayed on a package marked in accordance with this sub-section.

5.2.2

Labelling of packages

5.2.2.1

Labelling provisions

5.2.2.1.1

For each article or substance listed in Table A of Chapter 3.2, the labels shown in Column (5) shall be affixed unless otherwise provided for by a special provision in Column (6).

5.2.2.1.2

Indelible danger markings corresponding exactly to the prescribed models may be used instead of labels.

5.2.2.1.3- 5.2.2.1.5

(Reserved)

5.2.2.1.6

Except as provided in 5.2.2.1.2, each label shall:

- (a) be affixed to the same surface of the package, if the dimensions of the package allow; for packages of Class 1 and 7, near the mark indicating the proper shipping name;
- (b) be so placed on the package that it is not covered or obscured by any part or attachment to the packaging or any other label or marking; and

- (c) be displayed next to each other when more than one label is required.

Where a package is of such an irregular shape or small size that a label cannot be satisfactorily affixed, the label may be attached to the package by a securely affixed tag or other suitable means.

5.2.2.1.7 Intermediate bulk containers of more than 450 litres capacity and large packages shall be labelled on two opposite sides.

5.2.2.1.8 *(Reserved)*

5.2.2.1.9 *Special provisions for the labelling of self-reactive substances and organic peroxides*

- (a) the label conforming to model No. 4.1 also implies that the product may be flammable and hence no label conforming to model No. 3 is required. In addition, a label conforming to model No. 1 shall be applied for self-reactive substances Type B, unless the competent authority has permitted this label to be dispensed with for a specific packaging because test data have proven that the self-reactive substance in such a packaging does not exhibit explosive behaviour.
- (b) the label conforming to model No. 5.2 also implies that the product may be flammable and hence no label conforming to model No. 3 is required. In addition, the following labels shall be applied:
- (i) a label conforming to model No. 1 for organic peroxides type B, unless the competent authority has permitted this label to be dispensed with for a specific packaging because test data have proven that the organic peroxide in such a packaging does not exhibit explosive behaviour;
- (ii) a label conforming to model No. 8 is required when Packing Group I or II criteria of Class 8 are met.

For self-reactive substances and organic peroxides mentioned by name, the labels to be affixed are indicated in the list found in 2.2.41.4 and 2.2.52.4 respectively.

5.2.2.1.10 *Special provisions for the labelling of infectious substances packages*

In addition to the label conforming to model No. 6.2, infectious substances packages shall bear any other label required by the nature of the contents.

5.2.2.1.11 *Special provisions for the labelling of radioactive material*

5.2.2.1.11.1 Except when enlarged labels are used in accordance with 5.3.1.1.3, each package, overpack and container containing radioactive material shall bear at least two labels which conform to the models Nos. 7A, 7B, and 7C as appropriate according to the category (see 5.1.5.3.4) of that package, overpack or container. Labels shall be affixed to two opposite sides on the outside of the package or on the outside of all four sides of the container. Each overpack containing radioactive material shall bear at least two labels on opposite sides of the outside of the overpack. In addition, each package, overpack and container containing fissile material, other than fissile material excepted under 6.4.11.2 of ADR shall bear labels which conform to model No. 7E; such labels, where applicable shall be affixed adjacent to the labels for radioactive material. Labels shall not cover the markings specified in 5.2.1. Any labels which do not relate to the contents shall be removed or covered.

- 5.2.2.1.11.2 Each label conforming to models Nos. 7A, 7B, and 7C shall be completed with the following information:
- (a) *Contents*:
 - (i) except for LSA-I material, the name(s) of the radionuclide(s) as taken from Table 2.2.7.2.2.1, using the symbols prescribed therein. For mixtures of radionuclides, the most restrictive nuclides shall be listed to the extent the space on the line permits. The group of LSA or SCO shall be shown following the name(s) of the radionuclide(s). The terms “LSA-II”, “LSA-III”, “SCO-I” and “SCO-II” shall be used for this purpose;
 - (ii) for LSA-I material, only the term “LSA-I” is necessary; the name of the radionuclide is not necessary;
 - (b) *Activity*: The maximum activity of the radioactive contents during carriage expressed in becquerels (Bq) with the appropriate SI prefix symbol (see 1.2.2.1). For fissile material, the mass of fissile material (or mass of each fissile nuclide for mixtures when appropriate) in grams (g), or multiples thereof, may be used in place of activity;
 - (c) For overpacks and containers the “contents” and “activity” entries on the label shall bear the information required in (a) and (b) above, respectively, totalled together for the entire contents of the overpack or container except that on labels for overpacks or containers containing mixed loads of packages containing different radionuclides, such entries may read “See Transport Documents”;
 - (d) *Transport index (TI)*: The number determined in accordance with 5.1.5.3.1 and 5.1.5.3.2 (no transport index entry is required for category I-WHITE).
- 5.2.2.1.11.3 Each label conforming to the model No. 7E shall be completed with the criticality safety index (CSI) as stated in the certificate of approval for special arrangement or the certificate of approval for the package design issued by the competent authority.
- 5.2.2.1.11.4 For overpacks and containers, the criticality safety index (CSI) on the label shall bear the information required in 5.2.2.1.11.3 totalled together for the fissile contents of the overpack or container.
- 5.2.2.1.11.5 In all cases of international carriage of packages requiring competent authority design or shipment approval, for which different approval types apply in the different countries concerned by the shipment, labelling shall be in accordance with the certificate of the country of origin of design.

5.2.2.2 *Provisions for labels*

- 5.2.2.2.1 Labels shall satisfy the provisions below and conform, in terms of colour, symbols and general format, to the models shown in 5.2.2.2.2. Corresponding models required for other modes of transport, with minor variations which do not affect the obvious meaning of the label, are also acceptable.

NOTE: *Where appropriate, labels in 5.2.2.2.2 are shown with a dotted outer boundary as provided for in 5.2.2.2.1.1. This is not required when the label is applied on a background of contrasting colour.*

- 5.2.2.2.1.1 Labels shall be in the form of a square set at an angle of 45° (diamond-shaped) with minimum dimensions of 100 mm by 100 mm. They shall have a line 5 mm inside the edge and running parallel with it. In the upper half of a label the line shall have the same colour as the symbol and in the lower half it shall have the same colour as the figure in the bottom

corner. Labels shall be displayed on a background of contrasting colour, or shall have either a dotted or solid outer boundary line.

- 5.2.2.2.1.2 Gas cylinders for Class 2 may, on account of their shape, orientation and securing mechanisms for carriage, bear labels representative of those specified in this section and the environmentally hazardous substance mark when appropriate, which have been reduced in size, according to the dimensions outlined in ISO 7225:2005, “*Gas cylinders - Precautionary labels*”, for display on the non-cylindrical part (shoulder) of such cylinders.

Notwithstanding the provisions of 5.2.2.1.6, labels and the environmentally hazardous substance mark (see 5.2.1.8.3) may overlap to the extent provided for by ISO 7225:2005. However, in all cases, the primary risk label and the figures appearing on any label shall remain fully visible and the symbols recognizable.

Empty uncleaned pressure receptacles for gases of Class 2 may be carried with obsolete or damaged labels for the purposes of refilling or inspection as appropriate and the application of a new label in conformity with current regulations or for the disposal of the pressure receptacle.

- 5.2.2.2.1.3 With the exception of labels for Divisions 1.4, 1.5 and 1.6 of Class 1, the upper half of the label shall contain the pictorial symbol and the lower half shall contain:

- (a) For Classes 1, 2, 3, 5.1, 5.2, 7, 8 and 9, the class number;
- (b) For Classes 4.1, 4.2 and 4.3, the figure "4";
- (c) For Classes 6.1 and 6.2, the figure "6".

The label may include text such as the UN number or words describing the hazard (e.g. “flammable”) in accordance with 5.2.2.2.1.5 provided the text does not obscure or detract from the other required label elements.

- 5.2.2.2.1.4 In addition, except for Divisions 1.4, 1.5 and 1.6, labels for Class 1 shall show in the lower half, above the class number, the division number and the compatibility group letter for the substance or article. Labels for Divisions 1.4, 1.5 and 1.6 shall show in the upper half the division number, and in the lower half the class number and the compatibility group letter.

- 5.2.2.2.1.5 On labels other than those for material of Class 7, the optional insertion of any text (other than the class number) in the space below the symbol shall be confined to particulars indicating the nature of the risk and precautions to be taken in handling.

- 5.2.2.2.1.6 The symbols, text and numbers shall be clearly legible and indelible and shall be shown in black on all labels except for:

- (a) the Class 8 label, where the text (if any) and class number shall appear in white;
- (b) labels with entirely green, red or blue backgrounds where they may be shown in white;
- (c) the Class 5.2 label, where the symbol may be shown in white; and
- (d) labels conforming to model No. 2.1 displayed on cylinders and gas cartridges for gases of UN Nos. 1011, 1075, 1965 and 1978, where they may be shown in the background colour of the receptacle if adequate contrast is provided.

- 5.2.2.2.1.7 All labels shall be able to withstand open weather exposure without a substantial reduction in effectiveness.

5.2.2.2.2 Specimen labels

CLASS 1 HAZARD

Explosive substances or articles



(No. 1)

Divisions 1.1, 1.2 and 1.3

Symbol (exploding bomb): black; Background: orange; Figure '1' in bottom corner



(No. 1.4)

Division 1.4



(No. 1.5)

Division 1.5



(No. 1.6)

Division 1.6

Background: orange; Figures: black; Numerals shall be about 30 mm in height and be about 5 mm thick (for a label measuring 100 mm x 100 mm); Figure '1' in bottom corner

** Place for division - to be left blank if explosive is the subsidiary risk

* Place for compatibility group - to be left blank if explosive is the subsidiary risk

CLASS 2 HAZARD

Gases



(No. 2.1)

Flammable gases

Symbol (flame): black or white;

(except as provided for in 5.2.2.2.1.6 (d))

Background: red; Figure '2' in bottom corner



(No. 2.2)

Non flammable, non-toxic gases

Symbol (gas cylinder): black or white;

Background: green; Figure '2' in bottom corner

CLASS 3 HAZARD

Flammable liquids



(No. 2.3)

Toxic gases

Symbol (skull and crossbones): black;

Background: white; Figure '2' in bottom corner



(No. 3)

Symbol (flame): black or white;

Background: red; Figure '3' in bottom corner

CLASS 4.1 HAZARD
Flammable solids, self-reactive substances and solid desensitized explosives



(No. 4.1)
 Symbol (flame): black;
 Background: white with seven vertical red stripes;
 Figure '4' in bottom corner

CLASS 4.2 HAZARD
Substances liable to spontaneous combustion



(No. 4.2)
 Symbol (flame): black;
 Background: upper half white, lower half red;
 Figure '4' in bottom corner

CLASS 4.3 HAZARD
Substances which, in contact with water, emit flammable gases



(No. 4.3)
 Symbol (flame): black or white;
 Background: blue;
 Figure '4' in bottom corner

CLASS 5.1 HAZARD
Oxidizing substances



(No. 5.1)
 Symbol (flame over circle): black;
 Background: yellow;
 Figure '5.1' in bottom corner

CLASS 5.2 HAZARD
Organic peroxides



Symbol (flame): black or white;
 Background: upper half red; lower half yellow;
 Figure '5.2' in bottom corner

CLASS 6.1 HAZARD
Toxic substances



(No. 6.1)
 Symbol (skull and crossbones): black;
 Background: white; Figure '6' in bottom corner

CLASS 6.2 HAZARD
Infectious substances



(No. 6.2)
 The lower half of the label may bear the inscriptions: 'INFECTIOUS SUBSTANCE' and 'In the case of damage or leakage immediately notify Public Health Authority';
 Symbol (three crescents superimposed on a circle) and inscriptions: black;
 Background: white; Figure '6' in bottom corner

CLASS 7 HAZARD
Radioactive material



(No. 7A)
 Category I - White
 Symbol (trefoil): black;
 Background: white;
 Text (mandatory): black in lower half of label:
 'RADIOACTIVE'
 'CONTENTS'
 'ACTIVITY'
 One red bar shall
 follow the word 'RADIOACTIVE';
 Figure '7' in bottom corner.



(No 7B)
 Category II - Yellow
 Symbol (trefoil): black;
 Background: upper half yellow with white border, lower half white;
 Text (mandatory): black in lower half of label:
 'RADIOACTIVE'
 'CONTENTS'
 'ACTIVITY'
 In a black outlined box: 'TRANSPORT INDEX';
 Two red vertical bars shall follow the word 'RADIOACTIVE';
 Three red vertical bars shall follow the word 'RADIOACTIVE';
 Figure '7' in bottom corner.

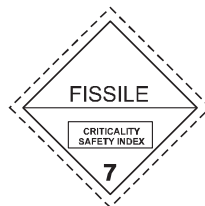

(No. 7E)
 Class 7 fissile material
 Background: white;
 Text (mandatory): black in upper half of label: 'FISSILE';
 In a black outlined box in the lower half of the label:
 'CRITICALITY SAFETY INDEX'
 Figure '7' in bottom corner.

CLASS 8 HAZARD
Corrosive substances

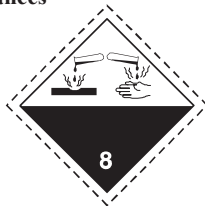

(No. 8)
 Symbol (liquids, spilling from two glass vessels
 and attacking a hand and a metal): black;
 Background: upper half white;
 lower half black with white border;
 Figure '8' in bottom corner

CLASS 9 HAZARD
Miscellaneous dangerous substances and articles

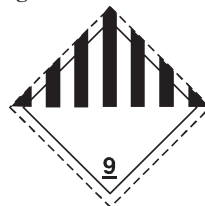

(No. 9)
 Symbol (seven vertical stripes in upper half): black;
 Background: white;
 Figure '9' underlined in bottom corner

CHAPTER 5.3

PLACARDING AND MARKING OF CONTAINERS, MEGCs, MEMUs, TANK-CONTAINERS, PORTABLE TANKS, VEHICLES AND WAGONS

NOTE: For marking and placarding of containers, MEGCs, tank-containers and portable tanks for carriage in a transport chain including a maritime journey, see also 1.1.4.2.1. If the provisions of 1.1.4.2.1 (c) are applied, only 5.3.1.3 and 5.3.2.1.1 of this Chapter are applicable.

5.3.1 Placarding

5.3.1.1 General provisions

5.3.1.1.1 As and when required in this section, placards shall be affixed to the exterior surface of containers, MEGCs, MEMUs, tank-containers, portable tanks, vehicles and wagons. Placards shall correspond to the labels required in Column (5) and, where appropriate, Column (6) of Table A of Chapter 3.2 for the dangerous goods contained in the container, MEGC, MEMU, tank-container, portable tank, vehicle or wagon and shall conform to the specifications given in 5.3.1.7. Placards shall be displayed on a background of contrasting colour, or shall have either a dotted or solid outer boundary line.

5.3.1.1.2 For Class 1, compatibility groups shall not be indicated on placards if the vehicle or wagon or container or special compartments of MEMUs are carrying substances or articles belonging to two or more compatibility groups. Vehicles or wagons or containers or special compartments of MEMUs carrying substances or articles of different divisions shall bear only placards conforming to the model of the most dangerous division in the order:

1.1 (most dangerous), 1.5, 1.2, 1.3, 1.6, 1.4 (least dangerous).

When 1.5D substances are carried with substances or articles of Division 1.2, the vehicle, wagon or container shall be placarded as Division 1.1.

Placards are not required for the carriage of explosives of Division 1.4, Compatibility Group S.

5.3.1.1.3 For Class 7, the primary risk placard shall conform to model No. 7D as specified in 5.3.1.7.2. This placard is not required for vehicles, wagons or containers carrying excepted packages and for small containers.

Where both Class 7 labels and placards would be required to be affixed to vehicles, wagons, containers, MEGCs, tank-containers or portable tanks, an enlarged label corresponding to the label required may be displayed instead of placard No. 7D to serve both purposes.

5.3.1.1.4 Containers, MEGCs, MEMUs, tank-containers, portable tanks, vehicles or wagons containing goods of more than one class need not bear a subsidiary risk placard if the hazard represented by that placard is already indicated by a primary or subsidiary risk placard.

5.3.1.1.5 Placards which do not relate to the dangerous goods being carried, or residues thereof, shall be removed or covered.

5.3.1.1.6 When the placarding is affixed to folding panels, they shall be designed and secured so that they cannot unfold or come loose from the holder during carriage (especially as a result of impacts or unintentional actions).

5.3.1.2 *Placarding of containers, MEGCs, tank-containers and portable tanks*

NOTE: *This subsection does not apply to swap-bodies, except tank swap bodies carried on vehicles bearing the orange markings stipulated in 5.3.2.*

The placards shall be affixed to both sides and at each end of the container, MEGC, tank-container or portable tank.

When the tank-container or portable tank has multiple compartments and carries two or more dangerous goods, the appropriate placards shall be displayed along each side at the position of the relevant compartments and one placard of each model shown on each side at both ends.

5.3.1.3 *Placarding of vehicles and wagons carrying containers, MEGCs, tank-containers or portable tanks*

NOTE: *This subsection does not apply to swap-bodies, except tank swap bodies carried on vehicles bearing the orange markings stipulated in 5.3.2.*

If the placards affixed to the containers, MEGCs, tank-containers or portable tanks are not visible from outside the carrying vehicles or wagons, the same placards shall also be affixed to both sides and at the rear of the vehicle or to both sides of the wagon. Otherwise, no placard need be affixed on the carrying vehicle or wagon.

5.3.1.4 *Placarding of vehicles for carriage in bulk, wagons for carriage in bulk, tank-vehicles, tank-wagons, battery vehicles, battery-wagons, MEMUs, vehicles with demountable tanks and wagons with demountable tanks*

5.3.1.4.1 Placards shall be affixed to both sides and at the rear of the vehicle, or, for wagons, to both sides.

When the tank-vehicle, tank-wagon, the demountable tank carried on the vehicle or the demountable tank carried on the wagon has multiple compartments and carries two or more dangerous goods, the appropriate placards shall be displayed along each side at the position of the relevant compartments and (vehicles only) one placard of each model shown on each side at the rear of the vehicle. However, in such case, if all compartments have to bear the same placards, these placards need be displayed only once along each side and (vehicles only) at the rear of the vehicle.

Where more than one placard is required for the same compartment, these placards shall be displayed adjacent to each other.

NOTE: *When a tank semi-trailer is separated from its tractor to be loaded on board a ship or a vessel, placards shall also be displayed at the front of the semi-trailer.*

5.3.1.4.2 MEMUs with tanks and bulk containers shall be placarded in accordance with 5.3.1.4.1 for the substances contained therein. For tanks with a capacity of less than 1 000 litres placards may be replaced by labels conforming to 5.2.2.2.

5.3.1.4.3 For MEMUs carrying packages containing substances or articles of Class 1 (other than of Division 1.4, Compatibility group S), placards shall be affixed to both sides and at the rear of the MEMU.

Special compartments for explosives shall be placarded in accordance with the provisions of 5.3.1.1.2. The last sentence of 5.3.1.1.2 does not apply.

5.3.1.5 *Placarding of vehicles and wagons carrying packages only*

NOTE: This sub-section applies also to vehicles or wagons carrying swap-bodies loaded with packages.

5.3.1.5.1 For vehicles carrying packages containing substances or articles of Class 1 (other than of Division 1.4, Compatibility Group S), placards shall be affixed to both sides and at the rear of the vehicle.

5.3.1.5.2 For vehicles carrying radioactive material of Class 7 in packagings or IBCs (other than excepted packages), placards shall be affixed to both sides and at the rear of the vehicle.

NOTE: If a vehicle carrying packages containing dangerous goods of classes other than Classes 1 and 7 is loaded on board a vessel for an ADN journey preceding a voyage by sea, placards shall be affixed to both sides and at the rear of the vehicle. Such placards may remain affixed to a vehicle for an ADN journey following a sea voyage.

5.3.1.5.3 For wagons carrying packages, placards corresponding to the goods carried shall be affixed to both sides.

5.3.1.6 *Placarding of empty tank-vehicles, tank-wagons, vehicles with demountable tanks, wagons with demountable tanks, battery-vehicles, battery-wagons, MEGCs, MEMUs, tank-containers, portable tanks and empty vehicles, wagons and containers for carriage in bulk*

5.3.1.6.1 Empty tank-vehicles, tank-wagons, vehicles with demountable tanks, wagons with demountable tanks, battery-vehicles, battery-wagons, MEGCs, MEMUs, tank-containers and portable tanks uncleaned and not degassed, and empty vehicles, wagons and containers for carriage in bulk, uncleaned, shall continue to display the placards required for the previous load.

5.3.1.7 *Specifications for placards*

5.3.1.7.1 Except as provided in 5.3.1.7.2 for the Class 7 placard, a placard shall:

(a) be not less than 250 mm by 250 mm and have a line 12.5 mm inside the edge and running parallel with it. In the upper half the line shall have the same colour as the symbol and in the lower half it shall have the same colour as the figure in the bottom corner;

(b) correspond to the label required for the dangerous goods in question with respect to colour and symbol (see 5.2.2.2); and

(c) display the numbers (and for goods of Class 1, the compatibility group letter) prescribed for the dangerous goods in question in 5.2.2.2 for the corresponding label, in digits not less than 25 mm high.

5.3.1.7.2 The Class 7 placard shall be not less than 250 mm by 250 mm with a black line running 5 mm inside the edge and parallel with it and is otherwise as shown below (Model No. 7D). The number “7” shall not be less than 25 mm high. The background colour of the upper half of the placard shall be yellow and of the lower half white, the colour of the trefoil and the printing shall be black. The use of the word “RADIOACTIVE” in the bottom half is optional to allow the use of this placard to display the appropriate UN number for the consignment.

Placard for radioactive material of Class 7

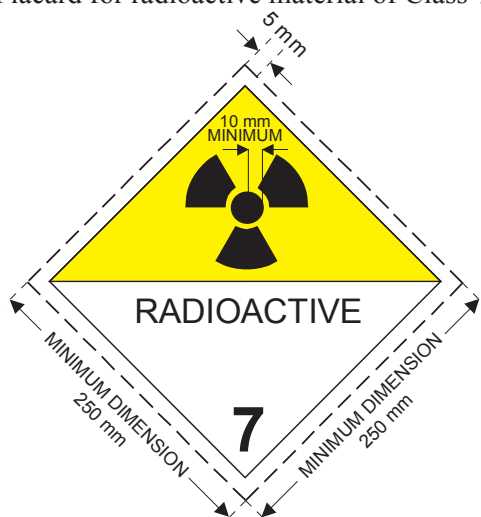

(No.7D)

Symbol (trefoil): black; Background: upper half yellow with white border, lower half white; The lower half shall show the word "RADIOACTIVE" or alternatively the appropriate UN Number and the figure "7" in the bottom corner.

5.3.1.7.3 For tanks with a capacity of not more than 3 m³ and for small containers, placards may be replaced by labels conforming to 5.2.2.2. If these labels are not visible from outside the carrying vehicle or wagon, placards according to 5.3.1.7.1 shall also be affixed to both sides of the wagon or to both sides and at the rear of the vehicle.

5.3.1.7.4 For Classes 1 and 7, if the size and construction of the vehicle are such that the available surface area is insufficient to affix the prescribed placards, their dimensions may be reduced to 100 mm on each side. The dimensions of the placards to be affixed to wagons may be reduced to 150 mm by 150 mm. In this case, the upper dimensions prescribed for the trefoil, lines, figures and letters do not apply.

5.3.2 Orange-coloured plate marking

5.3.2.1 General orange-coloured plate marking provisions

5.3.2.1.1 Transport units carrying dangerous goods shall display two rectangular orange-coloured plates conforming to 5.3.2.2.1, set in a vertical plane. They shall be affixed one at the front and the other at the rear of the transport unit, both perpendicular to the longitudinal axis of the transport unit. They shall be clearly visible.

If a trailer containing dangerous goods is detached from its motor vehicle during carriage of dangerous goods, an orange-coloured plate shall remain affixed to the rear of the trailer.

5.3.2.1.2 When a hazard identification number is indicated in Column (20) of Table A of Chapter 3.2 of ADR, tank-vehicles, battery vehicles or transport units having one or more tanks carrying dangerous goods shall in addition display on the sides of each tank, each tank compartment or each element of battery-vehicles, clearly visible and parallel to the longitudinal axis of the vehicle, orange-coloured plates identical with those prescribed in 5.3.2.1.1. These orange-coloured plates shall bear the hazard identification number and the UN number prescribed respectively in Columns (20) and (1) of Table A of Chapter 3.2 of ADR for each of the substances carried in the tank, in a compartment of the tank or in an element of a battery-vehicle.

The provisions of this paragraph are also applicable to tank-wagons, battery-wagons and wagons with demountable tanks. In the latter case the hazard identification number to be used is that indicated in column (20) of table A of Chapter 3.2 of RID. For MEMUs these requirements shall only apply to tanks with a capacity of 1 000 litres or more and bulk containers.

5.3.2.1.3 For tank-vehicles or transport units having one or more tanks carrying substances with UN Nos. 1202, 1203 or 1223, or aviation fuel classed under UN Nos. 1268 or 1863, but no other dangerous substance, the orange-coloured plates prescribed in 5.3.2.1.2 need not be affixed if the plates affixed to the front and rear in accordance with 5.3.2.1.1 bear the hazard identification number and the UN number prescribed for the most hazardous substance carried, i.e. the substance with the lowest flashpoint.

5.3.2.1.4 When a hazard identification number is indicated in Column (20) of Table A of Chapter 3.2 of ADR, transport units and containers carrying unpackaged solids or articles or packaged radioactive material with a single UN number required to be carried under exclusive use and no other dangerous goods shall in addition display on the sides of each transport unit or container, clearly visible and parallel to the longitudinal axis of the vehicle, orange-coloured plates identical with those prescribed in 5.3.2.1.1. These orange-coloured plates shall bear the hazard identification number and the UN number prescribed respectively in Columns (20) and (1) of Table A of Chapter 3.2 of ADR for each of the substances carried in bulk in the transport unit or in the container or for the packaged radioactive material when required to be carried under exclusive use in the transport unit or in the container.

The provisions of this paragraph are also applicable to wagons for carriage in bulk and full wagon loads comprising packages containing only one substance. In the latter case the hazard identification number to be used is that indicated in Column (20) of Table A of Chapter 3.2 of RID.

5.3.2.1.5 If the orange-coloured plates prescribed in 5.3.2.1.2 and 5.3.2.1.4 affixed to the containers, tank-containers, MEGCs or portable tanks are not clearly visible from outside the carrying vehicle or wagon, the same plates shall also be affixed to both sides of the vehicle or wagon.

***NOTE:** This paragraph need not be applied to the marking with orange coloured plates of closed and sheeted wagons or vehicles, carrying tanks with a maximum capacity of 3 000 litres.*

5.3.2.1.6 For transport units carrying only one dangerous substance and no non-dangerous substance, the orange-coloured plates prescribed in 5.3.2.1.2, 5.3.2.1.4 and 5.3.2.1.5 shall not be necessary provided that those displayed at the front and rear in accordance with 5.3.2.1.1 bear the hazard identification number and the UN number for that substance prescribed respectively in Columns (20) and (1) of Table A of Chapter 3.2 of ADR.

5.3.2.1.7 The requirements of 5.3.2.1.1 to 5.3.2.1.5 are also applicable to empty fixed or demountable tanks, battery-vehicles, tank-containers, portable tanks, MEGCs, tank-wagons, battery-wagons and wagons with demountable tanks, uncleaned, not degassed or not decontaminated, MEMUs, uncleaned as well as to empty vehicles, wagons and containers for carriage in bulk, uncleaned or not decontaminated.

5.3.2.1.8 Any orange-coloured marking which does not relate to dangerous goods carried, or residues thereof, shall be removed or covered. If plates are covered, the covering shall be total and remain effective after 15 minutes' engulfment in fire.

5.3.2.2 Specifications for the orange-coloured plates

5.3.2.2.1 The orange-coloured plates shall be reflectorized and shall be of 40 cm base and of 30 cm high; they shall have a black border of 15 mm wide. The material used shall be weather-resistant and ensure durable marking. The plate shall not become detached from its mount in the event of a 15 minutes' engulfment in fire. It shall remain affixed irrespective of the orientation of the vehicle or wagon. The orange-coloured plates may be separated in their middle with a black horizontal line of 15 mm thickness.

If the size and construction of the vehicle are such that the available surface area is insufficient to affix these orange-coloured plates, their dimensions may be reduced to 300 mm for the base, 120 mm for the height and 10 mm for the black border. In that case, for a packaged radioactive material carried under exclusive use, only the UN number is required, and the size of the digits stipulated in 5.3.2.2.2 may be reduced to 65 mm in height and 10 mm in stroke thickness.

A non-reflectorized colour is permitted for wagons.

For containers carrying dangerous solid substances in bulk and for tank-containers, MEGCs and portable tanks, the plates prescribed in 5.3.2.1.2, 5.3.2.1.4 and 5.3.2.1.5 may be replaced by a self-adhesive sheet, by paint or by any other equivalent process.

This alternative marking shall conform to the specifications set in this sub-section except for the provisions concerning resistance to fire mentioned in 5.3.2.2.1 and 5.3.2.2.2.

NOTE: The colour of the orange plates in conditions of normal use should have chromaticity coordinates lying within the area on the chromaticity diagram formed by joining the following coordinates:

<i>Chromaticity coordinates of points at the corners of the area on the chromaticity diagram</i>				
<i>x</i>	0.52	0.52	0.578	0.618
<i>y</i>	0.38	0.40	0.422	0.38

Luminance factor of reflectorized colour: $\beta > 0.12$.

Luminance factor of non-reflectorized colour (wagons): $\beta \geq 0.22$

Reference centre E, standard illuminant C, normal incidence 45°, viewed at 0°.

Coefficient of reflex luminous intensity at an angle of illumination of 5°, viewed at 0.2°: not less than 20 candelas per lux per m² (not required for wagons).

5.3.2.2.2 The hazard identification number and the UN number shall consist of black digits 100 mm high and of 15 mm stroke thickness. The hazard identification number shall be inscribed in the upper part of the plate and the UN number in the lower part; they shall be separated by a horizontal black line, 15 mm in stroke width, extending from side to side of the plate at mid-height (see 5.3.2.2.3). The hazard identification number and the UN number shall be indelible and shall remain legible after 15 minutes engulfment in fire. Interchangeable numbers and letters on plates presenting the hazard identification number and the UN number shall remain in place during carriage and irrespective of the orientation of the wagon or vehicle.

5.3.2.2.3 *Example of orange-coloured plate with hazard identification number and UN number*

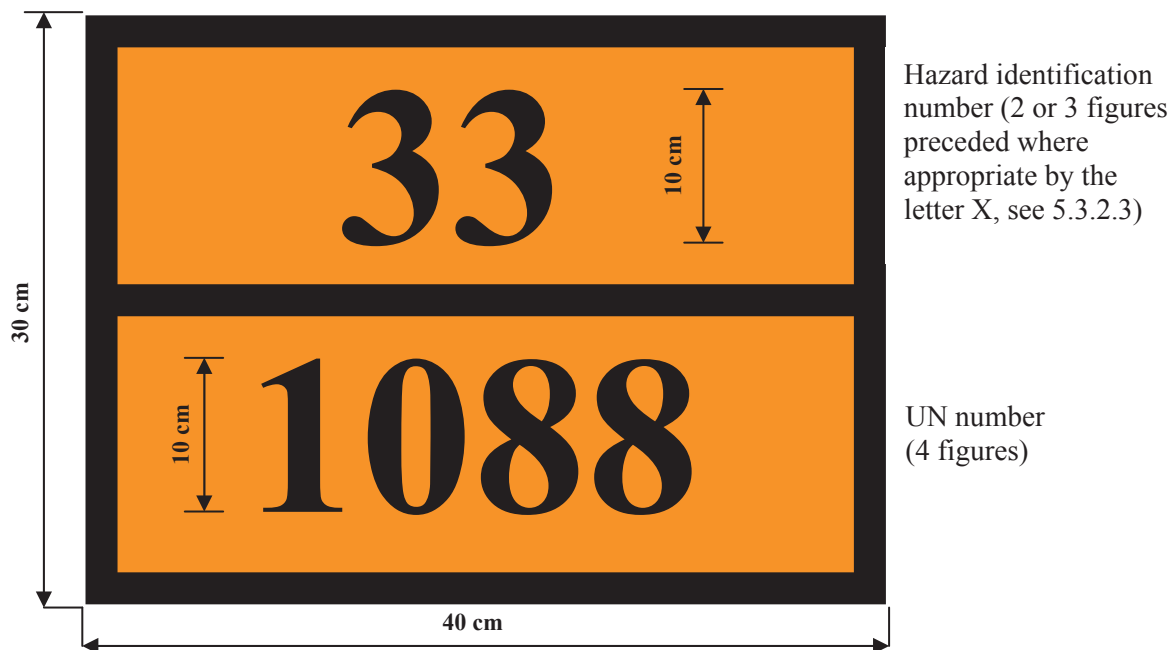

Background orange.
Border, horizontal line and figures black, 15 mm thickness.

5.3.2.2.4 The permitted tolerances for dimensions specified in this sub-section are $\pm 10\%$.

5.3.2.2.5 When the orange-coloured plate is affixed to folding panels, they shall be designed and secured so that they cannot unfold or come loose from the holder during carriage (especially as a result of impacts or unintentional actions).

5.3.2.3 *Meaning of hazard identification numbers*

5.3.2.3.1 The hazard identification number consists of two or three figures. In general, the figures indicate the following hazards:

- | | |
|---|--|
| 2 | Emission of gas due to pressure or to chemical reaction |
| 3 | Flammability of liquids (vapours) and gases or self-heating liquid |
| 4 | Flammability of solids or self-heating solid |
| 5 | Oxidizing (fire-intensifying) effect |
| 6 | Toxicity or risk of infection |
| 7 | Radioactivity |
| 8 | Corrosivity |
| 9 | Risk of spontaneous violent reaction |

NOTE: The risk of spontaneous violent reaction within the meaning of figure 9 includes the possibility following from the nature of a substance of a risk of explosion, disintegration and polymerization reaction following the release of considerable heat or flammable and/or toxic gases.

Doubling of a figure indicates an intensification of that particular hazard.

Where the hazard associated with a substance can be adequately indicated by a single figure, this is followed by zero.

The following combinations of figures, however, have a special meaning: 22, 323, 333, 362, 382, 423, 44, 446, 462, 482, 539, 606, 623, 642, 823, 842, 90 and 99 (see 5.3.2.3.2 below).

If a hazard identification number is prefixed by the letter “X”, this indicates that the substance will react dangerously with water. For such substances, water may only be used by approval of experts.

For substances of Class 1, the classification code in accordance with Column (3b) of Table A of Chapter 3.2, shall be used as the hazard identification number. The classification code consists of:

- the division number in accordance with 2.2.1.1.5; and
- the compatibility group letter in accordance with 2.2.1.1.6.

5.3.2.3.2

The hazard identification numbers listed in Column (20) of Table A of Chapter 3.2 of ADR or RID have the following meanings:

20	asphyxiant gas or gas with no subsidiary risk
22	refrigerated liquefied gas, asphyxiant
223	refrigerated liquefied gas, flammable
225	refrigerated liquefied gas, oxidizing (fire-intensifying)
23	flammable gas
238	gas, flammable corrosive
239	flammable gas, which can spontaneously lead to violent reaction
25	oxidizing (fire-intensifying) gas
26	toxic gas
263	toxic gas, flammable
265	toxic gas, oxidizing (fire-intensifying)
268	toxic gas, corrosive
28	gas, corrosive
285	gas, corrosive, oxidizing
30	flammable liquid (flashpoint between 23 °C and 60 °C, inclusive) or flammable liquid or solid in the molten state with a flashpoint above 60 °C, heated to a temperature equal to or above its flashpoint, or self-heating liquid
323	flammable liquid which reacts with water, emitting flammable gases
X323	flammable liquid which reacts dangerously with water, emitting flammable gases ¹
33	highly flammable liquid (flashpoint below 23 °C)
333	pyrophoric liquid
X333	pyrophoric liquid which reacts dangerously with water ¹
336	highly flammable liquid, toxic
338	highly flammable liquid, corrosive
X338	highly flammable liquid, corrosive, which reacts dangerously with water ¹
339	highly flammable liquid which can spontaneously lead to violent reaction
36	flammable liquid (flashpoint between 23 °C and 60 °C, inclusive), slightly toxic, or self-heating liquid, toxic
362	flammable liquid, toxic, which reacts with water, emitting flammable gases
X362	flammable liquid, toxic, which reacts dangerously with water, emitting flammable gases ¹
368	flammable liquid, toxic, corrosive
38	flammable liquid (flashpoint between 23 °C and 60 °C, inclusive), slightly corrosive or self-heating liquid, corrosive

¹ Water not to be used except by approval of experts.

382	flammable liquid, corrosive, which reacts with water, emitting flammable gases
X382	flammable liquid, corrosive, which reacts dangerously with water, emitting flammable gases ¹
39	flammable liquid, which can spontaneously lead to violent reaction
40	flammable solid, or self-reactive substance, or self-heating substance
423	solid which reacts with water, emitting flammable gases, or flammable solid which reacts with water, emitting flammable gases or self-heating solid which reacts with water, emitting flammable gases
X423	solid which reacts dangerously with water, emitting flammable gases, or flammable solid which reacts dangerously with water, emitting flammable gases, or self-heating solid which reacts dangerously with water, emitting flammable gases ¹
43	spontaneously flammable (pyrophoric) solid
X432	spontaneously flammable (pyrophoric) solid which reacts dangerously with water, emitting flammable gases ¹
44	flammable solid, in the molten state at an elevated temperature
446	flammable solid, toxic, in the molten state, at an elevated temperature
46	flammable or self-heating solid, toxic
462	toxic solid which reacts with water, emitting flammable gases
X462	solid which reacts dangerously with water, emitting toxic gases ¹
48	flammable or self-heating solid, corrosive
482	corrosive solid which reacts with water, emitting flammable gases
X482	solid which reacts dangerously with water, emitting corrosive gases ¹
50	oxidizing (fire-intensifying) substance
539	flammable organic peroxide
55	strongly oxidizing (fire-intensifying) substance
556	strongly oxidizing (fire-intensifying) substance, toxic
558	strongly oxidizing (fire-intensifying) substance, corrosive
559	strongly oxidizing (fire-intensifying) substance, which can spontaneously lead to violent reaction
56	oxidizing substance (fire-intensifying), toxic
568	oxidizing substance (fire-intensifying), toxic, corrosive
58	oxidizing substance (fire-intensifying), corrosive
59	oxidizing substance (fire-intensifying), which can spontaneously lead to violent reaction
60	toxic or slightly toxic substance
606	infectious substance
623	toxic liquid, which reacts with water, emitting flammable gases
63	toxic substance, flammable (flashpoint between 23 °C and 60 °C, inclusive)
638	toxic substance, flammable (flashpoint between 23 °C and 60 °C, inclusive), corrosive
639	toxic substance, flammable (flashpoint not above 60 °C) which can spontaneously lead to violent reaction
64	toxic solid, flammable or self-heating
642	toxic solid, which reacts with water, emitting flammable gases
65	toxic substance, oxidizing (fire-intensifying)
66	highly toxic substance
663	highly toxic substance, flammable (flashpoint not above 60 °C)
664	highly toxic solid, flammable or self-heating

¹ *Water not to be used except by approval of experts.*

665	highly toxic substance, oxidizing (fire-intensifying)
668	highly toxic substance, corrosive
X668	highly toxic substance, corrosive, which reacts dangerously with water ¹
669	highly toxic substance which can spontaneously lead to violent reaction
68	toxic substance, corrosive
69	toxic or slightly toxic substance, which can spontaneously lead to violent reaction
70	radioactive material
78	radioactive material, corrosive
80	corrosive or slightly corrosive substance
X80	corrosive or slightly corrosive substance, which reacts dangerously with water ¹
823	corrosive liquid which reacts with water, emitting flammable gases
83	corrosive or slightly corrosive substance, flammable (flashpoint between 23 °C and 60 °C, inclusive)
X83	corrosive or slightly corrosive substance, flammable (flashpoint between 23 °C and 60 °C, inclusive), which reacts dangerously with water ¹
839	corrosive or slightly corrosive substance, flammable (flashpoint between 23 °C and 60 °C inclusive) which can spontaneously lead to violent reaction
X839	corrosive or slightly corrosive substance, flammable (flashpoint between 23 °C and 60 °C inclusive), which can spontaneously lead to violent reaction and which reacts dangerously with water ¹
84	corrosive solid, flammable or self-heating
842	corrosive solid which reacts with water, emitting flammable gases
85	corrosive or slightly corrosive substance, oxidizing (fire-intensifying)
856	corrosive or slightly corrosive substance, oxidizing (fire-intensifying) and toxic
86	corrosive or slightly corrosive substance, toxic
88	highly corrosive substance
X88	highly corrosive substance, which reacts dangerously with water ¹
883	highly corrosive substance, flammable (flashpoint between 23 °C and 60 °C inclusive)
884	highly corrosive solid, flammable or self-heating
885	highly corrosive substance, oxidizing (fire-intensifying)
886	highly corrosive substance, toxic
X886	highly corrosive substance, toxic, which reacts dangerously with water ¹
89	corrosive or slightly corrosive substance, which can spontaneously lead to violent reaction
90	environmentally hazardous substance; miscellaneous dangerous substances
99	miscellaneous dangerous substance carried at an elevated temperature.

5.3.3 Mark for elevated temperature substances

Tank-vehicles, tank-wagons, tank-containers, portable tanks, special vehicles, special wagons or special containers or especially equipped vehicles, especially equipped wagons or especially equipped containers for which a mark for elevated temperature substances is required according to special provision 580 in Column (6) of Table A of Chapter 3.2 shall bear on both sides for wagons, on both sides and at the rear for vehicles, and on both sides and at each end for containers, tank-containers and portable tanks, a triangular shaped mark with sides of at least 250 mm, to be shown in red, as reproduced below.

¹ Water not to be used except by approval of experts.



5.3.4 Marking for carriage in a transport chain including maritime transport

5.3.4.1 For carriage in a transport chain including maritime transport, containers, portable tanks and MEGCs are not required to carry the orange-coloured plate marking according to section 5.3.2 if they carry the marking prescribed in section 5.3.2 of the IMDG Code, where:

- (a) The proper shipping name of the contents is durably marked on at least two sides:
 - of portable tanks and MEGCs;
 - of containers for carriage in bulk;
 - of containers containing dangerous goods in packages constituting only one substance for which the IMDG Code does not require a placard or the marine pollutant mark;
- (b) The UN number for the goods is displayed in black digits not less than 65 mm high:
 - either on a white background in the lower half of the placards affixed to the cargo transport unit;
 - or on an orange rectangular panel not less than 120 mm high and 300 mm wide, with a 10 mm black border, to be placed immediately adjacent to the placard or the marine pollutant marks of the IMDG Code, or, if no placard or marine pollutant mark is prescribed, adjacent to the proper shipping name.

**Example of marking for a portable tank carrying acetal,
class 3, UN No 1088, according to the IMDG Code**

FIRST VARIANT



black flame on
red background

SECOND VARIANT



black flame on
red background



orange background
border and digits in black

5.3.4.2 If portable tanks, MEGCs or containers marked in accordance with 5.3.4.1 are carried on board a vessel loaded on vehicles, only paragraph 5.3.2.1.1 applies to the carrying vehicle.

5.3.4.3 In addition to the placards, orange-coloured plate marking and marks prescribed or permitted by ADN, cargo transport units may carry additional marks, placards and other markings prescribed where appropriate by the IMDG Code, for example, the marine pollutant mark or the “LIMITED QUANTITIES” mark.

5.3.5 (*Reserved*)

5.3.6 Environmentally hazardous substance mark

When a placard is required to be displayed in accordance with the provisions of section 5.3.1, containers, MEGCs, tank-containers, portable tanks, vehicles and wagons containing environmentally hazardous substances meeting the criteria of 2.2.9.1.10 shall be marked with the environmentally hazardous substance mark shown in 5.2.1.8.3. The provisions of section 5.3.1 concerning placards shall apply mutatis mutandis to the mark.

CHAPTER 5.4

DOCUMENTATION

5.4.0 General

5.4.0.1 Unless otherwise specified, any carriage of goods governed by ADN shall be accompanied by the documentation prescribed in this Chapter, as appropriate.

NOTE: For the list of documentation to be carried on board vessels, see 8.1.2.

5.4.0.2 The use of electronic data processing (EDP) or electronic data interchange (EDI) techniques as an aid to or instead of paper documentation is permitted, provided that the procedures used for the capture, storage and processing of electronics data meet the legal requirements as regards the evidential value and availability of data during carriage in a manner at least equivalent to that of paper documentation.

5.4.0.3 When the dangerous goods transport information is given to the carrier by EDP or EDI techniques, the consignor shall be able to give the information to the carrier as a paper document, with the information in the sequence required by this Chapter.

5.4.1 Dangerous goods transport document and related information

5.4.1.1 General information required in the transport document

5.4.1.1.1 *General information required in the transport document for carriage in bulk or in packages*

The transport document(s) shall contain the following information for each dangerous substance, material or article offered for carriage:

- (a) the UN number, preceded by the letters "UN" or substance identification number;
- (b) the proper shipping name supplemented, when applicable (see 3.1.2.8.1) with the technical name in brackets (see 3.1.2.8.1.1), as determined in accordance with 3.1.2.
- (c) – For substances and articles of Class 1: the classification code given in Column (3b) of Table A of Chapter 3.2.

When, in Column (5) of Table A of Chapter 3.2, label model numbers are given other than 1, 1.4, 1.5 and 1.6, these label model numbers, in brackets, shall follow the classification code;

- For radioactive material of Class 7: the Class number: "7";

NOTE: For radioactive material with a subsidiary risk, see also special provision 172 in Chapter 3.3.

- For substances and articles of other classes: the label model numbers given in Column (5) of Table A of Chapter 3.2 or applicable according to a special provision referred to in Column (6). When more than one label model number is given, the numbers following the first one shall be given in brackets. For substances and articles for which no label model is given in Column (5) of Table A in Chapter 3.2, their class according to Column (3a) shall be given instead;

- (d) where assigned, the packing group for the substance which may be preceded by the letters “PG” (e.g. “PG II”), or the initials corresponding to the words “Packing Group” in the languages used according to 5.4.1.4.1;

NOTE: For radioactive material of Class 7 with subsidiary risks, see special provision 172 (b) in Chapter 3.3.

- (e) the number and a description of the packages when applicable. UN packaging codes may only be used to supplement the description of the kind of package (e.g. one box (4G));

NOTE: The number, type and capacity of each inner packaging within the outer packaging of a combination packaging is not required to be indicated.

- (f) the total quantity of each item of dangerous goods bearing a different UN number, proper shipping name (as a volume or as a gross mass, or as a net mass as appropriate);

NOTE: For dangerous goods in machinery and or equipment specified in these Regulations, the quantity indicated shall be the total quantity of dangerous goods contained therein in kilograms or litres as appropriate.

- (g) the name and address of the consignor;
- (h) the name and address of the consignee(s);
- (i) a declaration as required by the terms of any special agreement.

The location and order in which the elements of information required appear in the transport document is left optional, except that (a), (b), (c) and (d) shall be shown in the order listed above (i.e. (a), (b), (c), (d)) with no information interspersed, except as provided in ADN.

Examples of such permitted dangerous goods descriptions are:

**“UN 1098 ALLYL ALCOHOL, 6.1 (3), I” or
“UN1098, ALLYL ALCOHOL, 6.1 (3), PG I”**

The information required on a transport document shall be legible.

Although upper case is used in Chapter 3.1 and in Table A of Chapter 3.2 to indicate the elements which shall be part of the proper shipping name, and although upper and lower case are used in this Chapter to indicate the information required in the transport document, the use of upper or of lower case for entering the information in the transport document is left optional.

5.4.1.1.2

General information required in the transport document for carriage in tank vessels

The transport document(s) shall contain the following information for each dangerous substance or article offered for carriage:

- (a) the UN number preceded by the letters “UN” or the substance identification number;
- (b) the proper shipping name given in Column (2) of Table C of Chapter 3.2, supplemented, when applicable, by the technical name in parenthesis;

- (c) the data contained in column (5) of Table C of Chapter 3.2. When more than one number is given, the numbers following the first one shall be given in brackets. For substances not mentioned by name in Table C (assigned to a generic entry or a N.O.S. entry and for which the flowchart in 3.2.3.3 is applicable) only the actual dangerous properties of the substance shall be mentioned;
- (d) where assigned, the packing group for the substance, which may be preceded by the letters 'PG' (e.g. 'PG II'), or the initials corresponding to the words 'Packing Group' in the languages used in accordance with 5.4.1.4.1;
- (e) the mass in tonnes;
- (f) the name and address of the consignor;
- (g) the name and address of the consignee(s).

The location and order in which the elements of information required appear in the transport document is left optional, except that (a), (b), (c) and (d) shall be shown in the order listed above (i.e. (a), (b), (c), (d)) with no information interspersed, except as provided in ADN.

Examples of such permitted dangerous goods descriptions are:

"UN 1203 MOTOR SPIRIT, 3 (N2, CMR, F), II"; or
"UN 1203 MOTOR SPIRIT, 3 (N2, CMR, F), PG II"

The information required on a transport document shall be legible.

Although upper case is used in Chapter 3.1 and in Table C of Chapter 3.2 to indicate the elements which shall be part of the proper shipping name, and although upper and lower case are used in this Chapter to indicate the information required in the transport document, the use of upper or of lower case for entering the information in the transport document is left optional.

5.4.1.1.3 *Special provisions for wastes*

If waste containing dangerous goods (other than radioactive wastes) is being carried, the proper shipping name shall be preceded by the word **"WASTE"**, unless this term is part of the proper shipping name, e.g.:

"UN 1230 WASTE METHANOL, 3 (6.1), II", or
"UN 1230 WASTE METHANOL, 3 (6.1), PG II", or
"UN 1993 WASTE FLAMMABLE LIQUID, N.O.S. (toluene and ethyl alcohol), 3, II",
 or
"UN 1993 WASTE FLAMMABLE LIQUID, N.O.S. (toluene and ethyl alcohol), 3, PG II"

If the provision for waste as set out in 2.1.3.5.5 is applied, the following shall be added to the proper shipping name:

"WASTE IN ACCORDANCE WITH 2.1.3.5.5" (e.g. **"UN 3264, CORROSIVE LIQUID, ACIDIC, INORGANIC, N.O.S., 8, II, WASTE IN ACCORDANCE WITH 2.1.3.5.5"**).

The technical name, as prescribed in Chapter 3.3, special provision 274, need not be added.

5.4.1.1.4 *(Deleted)*

5.4.1.1.5 *Special provisions for salvage packagings and salvage pressure receptacles*

When dangerous goods are carried in a salvage packaging or salvage pressure receptacle, the words "**SALVAGE PACKAGING**" or "**SALVAGE PRESSURE RECEPTACLE**" shall be added after the description of the goods in the transport document.

5.4.1.1.6 *Special provision for empty means of containment and for empty cargo tanks of tank vessels*

5.4.1.1.6.1 For empty means of containment, uncleaned, which contain the residue of dangerous goods of classes other than Class 7, the words "EMPTY, UNCLEANNED" or "RESIDUE, LAST CONTAINED" shall be indicated before or after the dangerous goods description specified in 5.4.1.1.1 (a) to (d).. Moreover, 5.4.1.1.1 (f) does not apply.

5.4.1.1.6.2 The special provision of 5.4.1.1.6.1 may be replaced with the provisions of 5.4.1.1.6.2.1, 5.4.1.1.6.2.2 or 5.4.1.1.6.2.3, as appropriate.

5.4.1.1.6.2.1 For empty packagings, uncleaned, which contain the residue of dangerous goods of classes other than Class 7, including empty uncleaned receptacles for gases with a capacity of not more than 1000 litres, the particulars according to 5.4.1.1.1 (a), (b), (c), (d), (e) and (f) are replaced with "EMPTY PACKAGING", "EMPTY RECEPTACLE", "EMPTY IBC" or "EMPTY LARGE PACKAGING", as appropriate, followed by the information of the goods last loaded, as described in 5.4.1.1.1 (c).

Example:

"EMPTY PACKAGING, 6.1 (3)".

In addition, in such a case, if the dangerous goods last loaded are goods of Class 2, the information prescribed in 5.4.1.1.1 (c) may be replaced by the number of the class "2".

5.4.1.1.6.2.2 For empty means of containment other than packagings, uncleaned, which contain the residue of dangerous goods of classes other than Class 7 and for empty uncleaned receptacles for gases with a capacity of more than 1000 litres, the particulars according to 5.4.1.1.1 (a) to (d) are preceded by "EMPTY TANK-WAGON", "EMPTY TANK-VEHICLE", "EMPTY DEMOUNTABLE TANK", "EMPTY TANK-CONTAINER", "EMPTY PORTABLE TANK", "EMPTY BATTERY-WAGON", "EMPTY BATTERY-VEHICLE", "EMPTY MEGC", "EMPTY MEMU", "EMPTY WAGON", "EMPTY VEHICLE", "EMPTY CONTAINER" or "EMPTY RECEPTACLE", as appropriate, followed by the words "LAST LOAD:". Moreover, paragraph 5.4.1.1.1 (f) does not apply.

See example as follows:

**"EMPTY TANK-CONTAINER, LAST LOAD: UN 1098 ALLYL ALCOHOL, 6.1 (3), I" or
" EMPTY TANK-CONTAINER, LAST LOAD: UN 1098 ALLYL ALCOHOL, 6.1 (3), PG I".**

5.4.1.1.6.2.3 When empty means of containment, uncleaned, which contain the residue of dangerous goods of classes other than Class 7, are returned to the consignor, the transport documents prepared for the full-capacity carriage of these goods may also be used. In such cases, the indication of the quantity is to be eliminated (by effacing it, striking it out or any other means) and replaced by the words "EMPTY, UNCLEANNED RETURN".

5.4.1.1.6.3 (a) If empty tanks, battery-vehicles, battery wagons and MEGCs, uncleaned, are carried to the nearest place where cleaning or repair can be carried out in accordance with the

provisions of 4.3.2.4.3 of ADR or RID, the following additional entry shall be made in the transport document: **“Carriage in accordance with 4.3.2.4.3 of ADR (or RID)”**.

- (b) If empty vehicles, wagons and containers, uncleaned, are carried to the nearest place where cleaning or repair can be carried out in accordance with the provisions of 7.5.8.1 of ADR or RID, the following additional entry shall be made in the transport document: **“Carriage in accordance with 7.5.8.1 of ADR (or RID)”**.

5.4.1.1.6.4 For the carriage of tank wagons, fixed tanks (tank vehicles), wagons with removable tanks, vehicles with demountable tanks, battery-wagons, battery-vehicles, tank-containers and MEGCs under the conditions of 4.3.2.4.4 of ADR or RID, the following entry shall be included in the transport document: "Carriage in accordance with 4.3.2.4.4 of ADR (or RID)" as appropriate.

5.4.1.1.6.5 For tank vessels with empty cargo tanks or cargo tanks that have been discharged, the master is deemed to be the consignor for the purpose of the transport documents required. In this case, the following particulars shall be entered on the transport document for each empty cargo tank or cargo tank that has been discharged:

- (a) the number of the cargo tank;
- (b) the UN number preceded by the letters “UN” or the substance identification number;
- (c) the proper shipping name of the last substance carried, the class and, if applicable, the packing group in accordance with 5.4.1.1.2.

5.4.1.1.7 *Special provisions for carriage in a transport chain including maritime, road, rail or air carriage*

For carriage in accordance with 1.1.4.2.1, a statement shall be included in the transport document, as follows: **“Carriage in accordance with 1.1.4.2.1”**.

5.4.1.1.8-
5.4.1.1.9 *(Reserved)*

5.4.1.1.10 *(Deleted)*

5.4.1.1.11 *Special provisions for the carriage of IBCs or portable tanks after the date of expiry of the last periodic test or inspection*

For carriage in accordance with 4.1.2.2 (b), 6.7.2.19.6 (b), 6.7.3.15.6 (b) or 6.7.4.14.6 (b) of ADR or RID, a statement to this effect shall be included in the transport document, as follows: “Carriage in accordance with 4.1.2.2 (b) of ADR (or RID)”, “Carriage in accordance with 6.7.2.19.6 (b) of ADR (or RID)”, “Carriage in accordance with 6.7.3.15.6 (b) of ADR (or RID)” or “Carriage in accordance with 6.7.4.14.6 (b) of ADR (or RID)” as appropriate.

5.4.1.1.12-
5.4.1.1.13 *(Reserved)*

5.4.1.1.14 *Special provisions for the carriage of substances carried under elevated temperature*

If the proper shipping name of a substance which is carried or offered for carriage in a liquid state at a temperature equal to or exceeding 100 °C, or in a solid state at a temperature equal to or exceeding 240 °C, does not convey the elevated temperature condition (for example, by

- (b) For mixed packing of two different goods, the description of the goods in the transport document shall include the UN numbers and names printed in capitals in Columns (1) and (2) of Table A of Chapter 3.2 of both substances or articles. If more than two different goods are contained in the same package in conformity with the mixed packing provisions given in 4.1.10 of ADR special provisions MP1, MP2 and MP20 to MP24, the transport document shall indicate under the description of the goods the UN numbers of all the substances and articles contained in the package, in the form, “**Goods of UN Nos. ...**”.
- (c) For the carriage of substances and articles assigned to an n.o.s. entry or the entry “0190 SAMPLES, EXPLOSIVE” or packed conforming to packing instruction P101 of 4.1.4.1 of ADR, a copy of the competent authority approval with the conditions of carriage shall be attached to the transport document. It shall be in an official language of the forwarding country and also, if that language is not English, French or German, in English, French or German unless agreements, if any, concluded between the countries concerned in the transport operation provide otherwise.
- (d) If packages containing substances and articles of compatibility groups B and D are loaded together in the same vehicle or wagon in accordance with the requirements of 7.5.2.2 of ADR or RID, the approval certificate of the protective compartment or containment system in accordance with 7.5.2.2, note ^a under the table of ADR or RID, shall be attached to the transport document. It shall be in an official language of the forwarding country and also, if that language is not English, French or German, in English, French or German unless agreements, if any, concluded between the countries concerned in the transport operation provide otherwise.
- (e) When explosive substances or articles are carried in packagings conforming to packing instruction P101 of ADR, the transport document shall bear the inscription “**Packaging approved by the competent authority of ...**” (see 4.1.4.1, packing instruction P101).
- (f) *(Reserved)*
- (g) When fireworks of UN Nos. 0333, 0334, 0335, 0336 and 0337 are carried, the transport document shall bear the inscription:

"Classification of fireworks by the competent authority of XX with the firework reference XX/YYZZZZ".

The classification approval certificate need not be carried with the consignment, but shall be made available by the consignor to the carrier or the competent authorities for control purposes. The classification approval certificate or a copy of it shall be in an official language of the forwarding country, and also, if that language is not German, English or French, in German, English or French.

***NOTE 1:** The commercial or technical name of the goods may be entered additionally to the proper shipping name in the transport document.*

***NOTE 2:** The classification reference(s) shall consist of the ADN Contracting Party in which the classification code according to special provision 645 of 3.3.1 was approved, indicated by the distinguishing sign for motor vehicles in international*

5.4.1.2.3.5 When self-reactive substances type G (see Manual of Tests and Criteria, Part II, paragraph 20.4.2 (g)) are carried, the following statement may be given in the transport document: “**Not a self-reactive substance of Class 4.1**”.

When organic peroxides type G (see Manual of Tests and Criteria, Part II, paragraph 20.4.3 (g)) are carried, the following statement may be given in the transport document: “**Not a substance of Class 5.2**”.

5.4.1.2.4 *Additional provisions for Class 6.2*

In addition to the information concerning the consignee (see 5.4.1.1.1 (h)), the name and telephone number of a responsible person shall be indicated.

5.4.1.2.5 *Additional provisions for Class 7*

5.4.1.2.5.1 The following information shall be inserted in the transport document for each consignment of Class 7 material, as applicable, in the order given and immediately after the information required under 5.4.1.1.1 (a) to (c):

- (a) The name or symbol of each radionuclide or, for mixtures of radionuclides, an appropriate general description or a list of the most restrictive nuclides;
- (b) A description of the physical and chemical form of the material, or a notation that the material is special form radioactive material or low dispersible radioactive material. A generic chemical description is acceptable for chemical form. For radioactive material with a subsidiary risk, see last sentence of special provision 172 of Chapter 3.3;
- (c) The maximum activity of the radioactive contents during carriage expressed in becquerels (Bq) with an appropriate SI prefix symbol (see 1.2.2.1). For fissile material, the mass of fissile material (or mass of each fissile nuclide for mixtures when appropriate) in grams (g), or appropriate multiples thereof, may be used in place of activity;
- (d) The category of the package, i.e. I-WHITE, II-YELLOW, III-YELLOW;
- (e) The transport index (categories II-YELLOW and III-YELLOW only);
- (f) For consignments including fissile material other than consignments excepted under 6.4.11.2 of ADR, the criticality safety index;
- (g) The identification mark for each competent authority approval certificate (special form radioactive material, low dispersible radioactive material, special arrangement, package design, or shipment) applicable to the consignment;
- (h) For consignments of more than one package, the information required in 5.4.1.1.1 and in (a) to (g) above shall be given for each package. For packages in an overpack, container, or conveyance, a detailed statement of the contents of each package within the overpack, container, or conveyance and, where appropriate, of each overpack, container, or conveyance shall be included. If packages are to be removed from the overpack, container, or conveyance at a point of intermediate unloading, appropriate transport documents shall be made available;
- (i) Where a consignment is required to be shipped under exclusive use, the statement “**EXCLUSIVE USE SHIPMENT**”; and

- (j) For LSA-II and LSA-III substances, SCO-I and SCO-II, the total activity of the consignment as a multiple of A_2 . For radioactive material for which the A_2 value is unlimited, the multiple of A_2 shall be zero.

5.4.1.2.5.2 The consignor shall provide in the transport documents a statement regarding actions, if any, that are required to be taken by the carrier. The statement shall be in the languages deemed necessary by the carrier or the authorities concerned, and shall include at least the following information:

- (a) Supplementary requirements for loading, stowage, carriage, handling and unloading of the package, overpack or container including any special stowage provisions for the safe dissipation of heat (see 7.1.4.14.7.3.2), or a statement that no such requirements are necessary;
- (b) Restrictions on the mode of carriage or vehicle or wagon and any necessary routing instructions;
- (c) Emergency arrangements appropriate to the consignment.

5.4.1.2.5.3 In all cases of international carriage of packages requiring competent authorities design or shipment approval, for which different approval types apply in the different countries concerned by the shipment, the UN number and proper shipping name required in 5.4.1.1.1 shall be in accordance with the certificate of the country of origin of design.

5.4.1.2.5.4 The applicable competent authority certificates need not necessarily accompany the consignment. The consignor shall make them available to the carrier(s) before loading and unloading.

5.4.1.3 *(Reserved)*

5.4.1.4 *Format and language*

5.4.1.4.1 The document containing the information in 5.4.1.1 and 5.4.1.2 may be that already required by other regulations in force for carriage by another mode of carriage. In case of multiple consignees, the name and address of the consignees and the quantities delivered enabling the nature and quantities carried to be evaluated at any time, may be entered in other documents which are to be used or in any other documents made mandatory according to other specific regulations and which shall be on board.

The particulars to be entered in the document shall be drafted in an official language of the forwarding country, and also, if that language is not English, French or German, in English, French or German, unless agreements concluded between the countries concerned in the transport operation, provide otherwise.

5.4.1.4.2 If by reason of the size of the load, a consignment cannot be loaded in its entirety on a single transport unit, at least as many separate documents, or copies of the single document, shall be made out as transport units loaded. Furthermore, in all cases, separate transport documents shall be made out for consignments or parts of consignments which may not be loaded together on the same vehicle by reason of the prohibitions set forth in 7.5.2 of ADR.

The information relative to the hazards of the goods to be carried (as indicated in 5.4.1.1) may be incorporated in, or combined with, an existing transport or cargo handling document. The layout of the information in the document (or the order of transmission of the corresponding data by electronic data processing (EDP) or electronic data interchange (EDI) techniques) shall be as provided in 5.4.1.1.1 or 5.4.1.1.2 as relevant.

When an existing transport document or cargo handling document cannot be used for the purposes of dangerous goods documentation for multimodal transport, the use of documents corresponding to the example shown in 5.4.5 is considered advisable.³

5.4.1.5 *Non-dangerous goods*

When goods mentioned by name in Table A of Chapter 3.2, are not subject to ADN because they are considered as non-dangerous according to Part 2, the consignor may enter in the transport document a statement to that effect, e.g.: “**Not goods of Class ...**”

NOTE: This provision may be used in particular when the consignor considers that, due to the chemical nature of the goods (e.g. solutions and mixtures) carried or to the fact that such goods are deemed dangerous for other regulatory purposes the consignment might be subject to control during the journey.

5.4.2 **Large container, vehicle or wagon packing certificate**

If the carriage of dangerous goods in a large container precedes a voyage by sea, a container packing certificate conforming to section 5.4.2 of the IMDG Code⁴ shall be provided with the transport document.⁵

³ If used, the relevant recommendations of the UNECE United Nations Centre for Trade Facilitation and Electronic Business (UN/CEFACT) may be consulted, in particular Recommendation No. 1 (United Nations Layout Key for Trade Documents) (ECE/TRADE/137, edition 81.3), UN Layout Key for Trade Documents - Guidelines for Applications (ECE/TRADE/270, edition 2002), Recommendation No. 11 (Documentary Aspects of the International Transport of Dangerous Goods) (ECE/TRADE/204, edition 96.1 – currently under revision) and Recommendation No. 22 (Layout Key for Standard Consignment Instructions) (ECE/TRADE/168, edition 1989). Refer also to the UN/CEFACT Summary of Trade Facilitation Recommendations (ECE/TRADE/346, edition 2006) and the United Nations Trade Data Elements Directory (UNTDDED) (ECE/TRADE/362, edition 2005).

⁴ Guidelines for use in practice and in training for loading goods in transport units have also been drawn up by the International Maritime Organization (IMO), the International Labour Organization (ILO) and the United Nations Economic Commission for Europe (UNECE) and have been published by IMO (“IMO/ILO/UNECE Guidelines for Packing of Cargo Transport Units (CTUs)”).

⁵ Section 5.4.2 of the IMDG Code requires the following:

"5.4.2 Container/vehicle packing certificate

5.4.2.1 When dangerous goods are packed or loaded into any container or vehicle, those responsible for packing the container or vehicle shall provide a “container/vehicle packing certificate” specifying the container/vehicle identification number(s) and certifying that the operation has been carried out in accordance with the following conditions:

- .1 The container/vehicle was clean, dry and apparently fit to receive the goods;
- .2 Packages, which need to be segregated in accordance with applicable segregation requirements, have not been packed together onto or in the container/vehicle (unless approved by the competent authority concerned in accordance with 7.2.2.3 (of the IMDG Code));
- .3 All packages have been externally inspected for damage, and only sound packages have been loaded;

The functions of the transport document required under 5.4.1 and of the container packing certificate as provided above may be incorporated into a single document; if not, these documents shall be attached one to the other. If these functions are incorporated into a single document, the inclusion in the transport document of a statement that the loading of the container has been carried out in accordance with the applicable modal regulations together with the identification of the person responsible for the container packing certificate shall be sufficient.

NOTE: The container packing certificate is not required for portable tanks, tank-containers and MEGCs.

-
- .4 Drums have been stowed in an upright position, unless otherwise authorised by the competent authority, and all goods have been properly loaded, and, where necessary, adequately braced with securing material to suit the mode(s) of transport for the intended journey;*
 - .5 Goods loaded in bulk have been evenly distributed within the container/vehicle;*
 - .6 For consignments including goods of class 1, other than division 1.4, the container/vehicle is structurally serviceable in conformity with 7.4.6 (of the IMDG Code);*
 - .7 The container/vehicle and packages are properly marked, labelled, and placarded, as appropriate;*
 - .8 When solid carbon dioxide (CO₂-dry ice) is used for cooling purposes, the container/vehicle is externally marked or labelled in a conspicuous place, such as, at the door end, with the words: "DANGEROUS CO₂ GAS (DRY ICE) INSIDE. VENTILATE THOROUGHLY BEFORE ENTERING"; and*
 - .9 A dangerous goods transport document, as indicated in 5.4.1 (of the IMDG Code) has been received for each dangerous goods consignment loaded in the container/vehicle.*

NOTE: The container/vehicle packing certificate is not required for tanks.

5.4.2.2 The information required in the dangerous goods transport document and the container/vehicle packing certificate may be incorporated into a single document; if not, these documents shall be attached one to the other. If the information is incorporated into a single document, the document shall a signed declaration such as "It is declared that the packing of the goods into the container/vehicle has been carried out in accordance with the applicable provisions". This declaration shall be dated and the person signing this declaration shall be identified on the document. Facsimile signatures are acceptable where applicable laws and regulations recognize the legal validity of facsimile signatures.

5.4.2.3 If the container/vehicle packing certificate is presented to the carrier by means of EDP or EDI transmission techniques, the signature(s) may be electronic signature(s) or may be replaced by the name(s) (in capitals) of the person authorized to sign.

5.4.2.4 When the container/vehicle packing certificate is given to a carrier by EDP or EDI techniques and subsequently the dangerous goods are transferred to a carrier that requires a paper dangerous goods transport document, the carrier shall ensure that the paper document indicates "Original received electronically" and the name of the signatory shall be shown in capital letters."









5.4.3 Instructions in writing



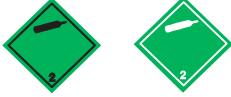





- 5.4.3.1** As an aid during an accident emergency situation that may occur or arise during carriage, instructions in writing in the form specified in 5.4.3.4 shall be carried in the wheelhouse and shall be readily available.
- 5.4.3.2** These instructions shall be provided by the carrier to the master in the language(s) that the master and the expert can read and understand before loading. The master shall ensure that each member of the crew concerned understands and is capable of carrying out the instructions properly.
- 5.4.3.3** Before loading, the members of the crew shall inform themselves of the dangerous goods to be loaded and consult the instructions in writing for details on actions to be taken in the event of an accident or emergency.
- 5.4.3.4** The instructions in writing shall correspond to the following four-page model as regards its form and contents.

INSTRUCTIONS IN WRITING ACCORDING TO ADN
Actions in the event of an accident or incident

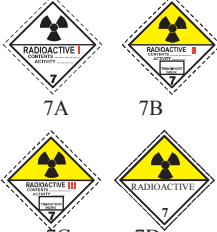

In the event of an accident or incident that may occur during carriage, the members of the crew shall take the following actions where safe and practicable to do so:

- Inform all other persons on board about the emergency and keep them away as much as possible from the danger zone. Alert other vessels in the vicinity;
- Avoid sources of ignition, in particular, do not smoke or switch on any electrical equipment that is not the “certified safe” type and is not designed for use in emergency response;
- Inform the appropriate body, giving as much information about the accident or incident and substances involved as possible;
- Keep the transport documents and the loading plan readily available for responders on arrival;
- Do not walk into or touch spilled substances and avoid inhalation of fumes, smoke, dusts and vapours by staying up wind;
- Where appropriate and safe to do so, tackle small/initial fires;
- Where appropriate and safe to do so, use on-board equipment to prevent leakages into the aquatic environment and contain spillages;
- Where necessary and safe to do so, secure the ship against drifting;
- Where appropriate, move away from the vicinity of the accident or incident, advise other persons to move away and follow the advice of the appropriate body;
- Remove any contaminated clothing and used contaminated protective equipment, dispose of it safely and wash the body by appropriate means;
- Observe the additional guidance assigned to the hazards of all concerned goods in the following table. For carriage in packages or in bulk, the hazards correspond to the number of the danger label model; for carriage in tank vessels to the data in accordance with 5.4.1.1.2 (c).

Additional guidance to members of the crew on the hazard characteristics of dangerous goods by class and on actions to be taken subject to prevailing circumstances		
Danger labels and placards, description of the hazards	Hazard characteristics	Additional guidance
(1)	(2)	(3)
Explosive substances and articles  1 1.5 1.6	May have a range of properties and effects such as mass detonation; projection of fragments; intense fire/heat flux; formation of bright light, loud noise or smoke. Sensitive to shocks and/or impacts and/or heat.	Take cover but stay away from windows. Steer the vessel as far away as possible from infrastructure and inhabited areas.
Explosive substances and articles  1.4	Slight risk of explosion and fire.	Take cover.
Flammable gases  2.1	Risk of fire. Risk of explosion. May be under pressure. Risk of asphyxiation. May cause burns and/or frostbite. Containments may explode when heated.	Take cover. Keep out of low areas.
Non-flammable, non-toxic gases  2.2	Risk of asphyxiation. May be under pressure. May cause frostbite. Containments may explode when heated.	Take cover. Keep out of low areas.
Toxic gases  2.3	Risk of intoxication. May be under pressure. May cause burns and/or frostbite. Containments may explode when heated.	Use emergency escape mask. Take cover. Keep out of low areas.
Flammable liquids  3	Risk of fire. Risk of explosion. Containments may explode when heated.	Take cover. Keep out of low areas.
Flammable solids, self-reactive substances and solid desensitized explosives  4.1	Risk of fire. Flammable or combustible, may be ignited by heat, sparks or flames. May contain self-reactive substances that are liable to exothermic decomposition in the case of heat supply, contact with other substances (such as acids, heavy-metal compounds or amines), friction or shock. This may result in the evolution of harmful and flammable gases or vapours or self-ignition. Containments may explode when heated. Risk of explosion of desensitized explosives after loss of desensitizer.	
Substances liable to spontaneous combustion  4.2	Risk of fire by spontaneous combustion if packages are damaged or contents spilled. May react vigorously with water.	
Substances which, in contact with water, emit flammable gases  4.3	Risk of fire and explosion in contact with water.	Spilled substances should be kept dry by covering the spillages.

Danger labels and placards, description of the hazards	Hazard characteristics	Additional guidance
(1)	(2)	(3)
Oxidizing substances  5.1	Risk of vigorous reaction, ignition and explosion in contact with combustible or flammable substances.	Avoid mixing with flammable or combustible substances (e.g. sawdust).
Organic peroxides  5.2	Risk of exothermic decomposition at elevated temperatures, contact with other substances (such as acids, heavy-metal compounds or amines), friction or shock. This may result in the evolution of harmful and flammable gases or vapours or self-ignition.	Avoid mixing with flammable or combustible substances (e.g. sawdust).
Toxic substances  6.1	Risk of intoxication by inhalation, skin contact or ingestion. Risk to the aquatic environment.	Use emergency escape mask.
Infectious substances  6.2	Risk of infection. May cause serious disease in humans or animals Risk to the aquatic environment.	
Radioactive material  7A 7B 7C 7D	Risk of intake and external radiation.	Limit time of exposure.
Fissile material  7E	Risk of nuclear chain reaction.	
Corrosive substances  8	Risk of burns by corrosion. May react vigorously with each other, with water and with other substances. Spilled substance may evolve corrosive vapours. Risk to the aquatic environment.	
Miscellaneous dangerous substances and articles  9	Risk of burns. Risk of fire. Risk of explosion. Risk to the aquatic environment	

- NOTE:**
1. For dangerous goods with multiple risks and for mixed loads, each applicable entry shall be observed.
 2. Additional guidance shown above may be adapted to reflect the classes of dangerous goods to be carried and their means of transport.
 3. Risks see also entries in the transport document as well as Chapter 3.2, Table C, Column (5).

Additional guidance to members of the crew on the hazard characteristics of dangerous goods, indicated by marks, and on actions to be taken subject to prevailing circumstances		
Mark (1)	Hazard characteristics (2)	Additional guidance (3)
 Environmentally hazardous substances	Risk to the aquatic environment.	
 Elevated temperature substances	Risk of burns by heat.	Avoid contact with hot parts of the transport unit and the spilled substance.

Equipment for personal and general protection to carry out general actions and hazard specific emergency actions to be carried on board the vessel in accordance with section 8.1.5 of ADN

The equipment required by Chapter 3.2, Table A, Column (9) and Table C, Column (18) shall be carried on board the vessel for all hazards listed in the transport document.

5.4.4 Retention of dangerous goods transport information

5.4.4.1 The consignor and the carrier shall retain a copy of the dangerous goods transport document and additional information and documentation as specified in ADN, for a minimum period of three months.

5.4.4.2 When the documents are kept electronically or in a computer system, the consignor and the carrier shall be able to reproduce them in a printed form.

5.4.5. Example of a multimodal dangerous goods form

Example of a form which may be used as a combined dangerous goods declaration and container packing certificate for multimodal carriage of dangerous goods.

MULTIMODAL DANGEROUS GOODS FORM

Continuation Sheet

1. Shipper/Consignor/Sender	2. Transport document number	
	3. Page 1 of pages	4. Shipper's reference
	5. Freight Forwarder's reference	

14. Shipping marks	* Number and kind of packages; description of goods	Gross mass (kg)	Net mass	Cube (m ³)
--------------------	---	-----------------	----------	------------------------

* FOR DANGEROUS GOODS; you must specify: proper shipping name, hazard class, UN No., packing group (where assigned) and any other element of information required under applicable national and international regulations

BLACK HATCHINGS BLACK HATCHINGS BLACK HATCHINGS BLACK HATCHINGS BLACK HATCHINGS BLACK HATCHINGS BLACK HATCHINGS BLACK HATCHINGS BLACK HATCHINGS

CHAPTER 5.5

SPECIAL PROVISIONS

5.5.1 *(Deleted)*

5.5.2 **Special provisions applicable to fumigated cargo transport units (UN 3359)**

5.5.2.1 ***General***

5.5.2.1.1 Fumigated cargo transport units (UN 3359) containing no other dangerous goods are not subject to any provisions of ADN other than those of this section.

5.5.2.1.2 When the fumigated cargo transport unit is loaded with dangerous goods in addition to the fumigant, any provision of ADN relevant to these goods (including placarding, marking and documentation) applies in addition to the provisions of this section.

5.5.2.1.3 Only cargo transport units that can be closed in such a way that the escape of gas is reduced to a minimum shall be used for the carriage of cargo under fumigation.

5.5.2.2 ***Training***

Persons engaged in the handling of fumigated cargo transport units shall be trained commensurate with their responsibilities.

5.5.2.3 ***Marking and placarding***

5.5.2.3.1 A fumigated cargo transport unit shall be marked with a warning mark, as specified in 5.5.2.3.2, affixed at each access point in a location where it will be easily seen by persons opening or entering the cargo transport unit. This mark shall remain on the cargo transport unit until the following provisions are met:

(a) The fumigated cargo transport unit has been ventilated to remove harmful concentrations of fumigant gas; and

(b) The fumigated goods or materials have been unloaded.

5.5.2.3.2 The fumigation warning mark shall be rectangular and shall not be less than 300 mm wide and 250 mm high. The markings shall be in black print on a white background with lettering not less than 25 mm high. An illustration of this mark is given in the figure below.

Fumigation warning mark

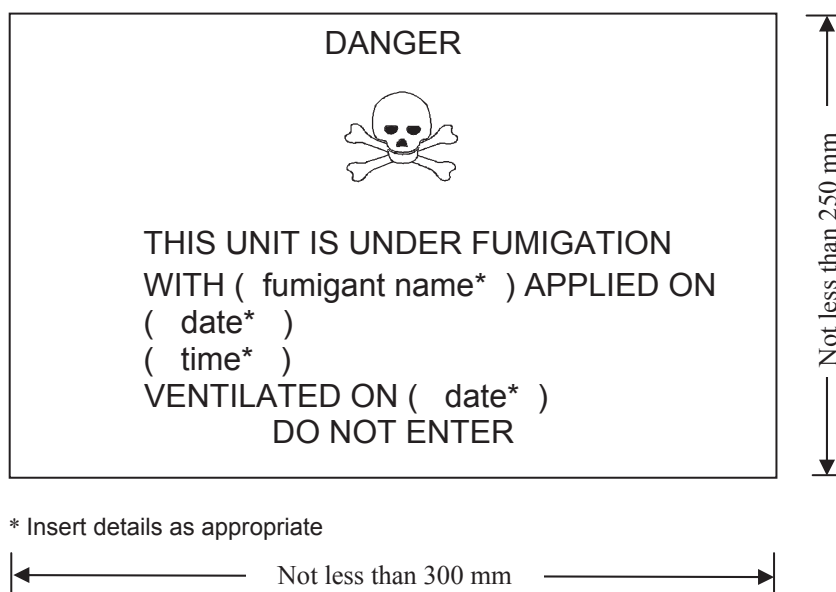

5.5.2.3.3 If the fumigated cargo transport unit has been completely ventilated either by opening the doors of the unit or by mechanical ventilation after fumigation, the date of ventilation shall be marked on the fumigation warning mark.

5.5.2.3.4 When the fumigated cargo transport unit has been ventilated and unloaded, the fumigation warning mark shall be removed.

5.5.2.3.5 Placards conforming to model No. 9 (see 5.2.2.2.2) shall not be affixed to a fumigated cargo transport unit except as required for other Class 9 substances or articles packed therein.

5.5.2.4 **Documentation**

5.5.2.4.1 Documents associated with the carriage of cargo transport units that have been fumigated and have not been completely ventilated before carriage shall include the following information:

- "UN 3359, fumigated cargo transport unit, 9", or "UN 3359, fumigated cargo transport unit, class 9";
- The date and time of fumigation; and
- The type and amount of the fumigant used.

These particulars shall be drafted in an official language of the forwarding country and also, if the language is not English, French or German, in English, French or German, unless agreements, if any, concluded between the countries concerned in the transport operation provide otherwise.

5.5.2.4.2 The documents may be in any form, provided they contain the information required in 5.5.2.4.1. This information shall be easy to identify, legible and durable.

- 5.5.2.4.3 Instructions for disposal of any residual fumigant including fumigation devices (if used) shall be provided.
- 5.5.2.4.4 A document is not required when the fumigated cargo transport unit has been completely ventilated and the date of ventilation has been marked on the warning mark (see 5.5.2.3.3 and 5.5.2.3.4).
- 5.5.3 Special provisions applicable to packages and vehicles and containers containing substances presenting a risk of asphyxiation when used for cooling or conditioning purposes (such as dry ice (UN 1845) or nitrogen, refrigerated liquid (UN 1977) or argon, refrigerated liquid (UN 1951))**
- 5.5.3.1 *Scope***
- 5.5.3.1.1 This section is not applicable to substances which may be used for cooling or conditioning purposes when carried as a consignment of dangerous goods. When they are carried as a consignment, these substances shall be carried under the relevant entry of Table A in Chapter 3.2 in accordance with the associated conditions of carriage.
- 5.5.3.1.2 This section is not applicable to gases in cooling cycles.
- 5.5.3.1.3 Dangerous goods used for cooling or conditioning tanks or MEGCs during carriage are not subject to this section.
- 5.5.3.2 *General***
- 5.5.3.2.1 Vehicles and containers containing substances used for cooling or conditioning purposes (other than fumigation) during carriage are not subject to any provisions of ADN other than those of this section.
- 5.5.3.2.2 When dangerous goods are loaded in cooled or conditioned vehicles and containers any provisions of ADN relevant to these dangerous goods apply in addition to the provisions of this section.
- 5.5.3.2.3 (*Reserved*)
- 5.5.3.2.4 Persons engaged in the handling or carriage of cooled or conditioned vehicles and containers shall be trained commensurate with their responsibilities.
- 5.5.3.3 *Packages containing a coolant or conditioner***
- 5.5.3.3.1 Packaged dangerous goods requiring cooling or conditioning assigned to packing instructions P203, P620, P650, P800, P901 or P904 of 4.1.4.1 of ADR shall meet the appropriate requirements of that packing instruction.
- 5.5.3.3.2 For packaged dangerous goods requiring cooling or conditioning assigned to other packing instructions, the packages shall be capable of withstanding very low temperatures and shall not be affected or significantly weakened by the coolant or conditioner. Packages shall be designed and constructed to permit the release of gas to prevent a build-up of pressure that could rupture the packaging. The dangerous goods shall be packed in such a way as to prevent movement after the dissipation of any coolant or conditioner.
- 5.5.3.3.3 Packages containing a coolant or conditioner shall be carried in well ventilated vehicles and containers.

5.5.3.4 *Marking of packages containing a coolant or conditioner*

5.5.3.4.1 Packages containing dangerous goods used for cooling or conditioning shall be marked with the name indicated in Column (2) of Table A of Chapter 3.2 of these dangerous goods followed by the words "AS COOLANT" or "AS CONDITIONER" as appropriate in an official language of the country of origin and also, if that language is not English, French or German, in English, French or German, unless agreements concluded between the countries concerned in the transport operation provide otherwise.

5.5.3.4.2 The markings shall be durable, legible and placed in such a location and of such a size relative to the package as to be readily visible.

5.5.3.5 *Vehicles and containers containing unpackaged dry ice*

5.5.3.5.1 If dry ice in unpackaged form is used, it shall not come into direct contact with the metal structure of a vehicle or container to avoid embrittlement of the metal. Measures shall be taken to provide adequate insulation between the dry ice and the vehicle or container by providing a minimum of 30 mm separation (e.g. by using suitable low heat conducting materials such as timber planks, pallets etc).

5.5.3.5.2 Where dry ice is placed around packages, measures shall be taken to ensure that packages remain in the original position during carriage after the dry ice has dissipated.

5.5.3.6 *Marking of vehicles and containers*

5.5.3.6.1 Vehicles and containers containing dangerous goods used for cooling or conditioning shall be marked with a warning mark, as specified in 5.5.3.6.2 affixed at each access point in a location where it will be easily seen by persons opening or entering the vehicle or container. This mark shall remain on the vehicle or container until the following provisions are met:

- (a) The vehicle or container has been ventilated to remove harmful concentrations of coolant or conditioner; and
- (b) The cooled or conditioned goods have been unloaded.

5.5.3.6.2 The warning mark shall be rectangular and shall not be less than 150 mm wide and 250 mm high. The warning mark shall include:

- (a) The word "WARNING" in red or white with lettering not less than 25 mm high in an official language of the country of origin and also, if that language is not English, French or German, in English, French or German, unless agreements concluded between the countries concerned in the transport operation provide otherwise; and
- (b) The name indicated in Column (2) of Table A of Chapter 3.2 followed by the words "AS COOLANT" or "AS CONDITIONER" as appropriate, shown below the symbol in black letters on a white background with lettering not less than 25 mm high in an official language of the country of origin and also, if that language is not English, French or German, in English, French or German, unless agreements concluded between the countries concerned in the transport operation provide otherwise.

For example: CARBON DIOXIDE, SOLID, AS COOLANT.

An illustration of this mark is given below.



* Insert the name indicated in Column (2) of Table A of Chapter 3.2 followed by the words "AS COOLANT" or "AS CONDITIONER" as appropriate.

5.5.3.7 Documentation

5.5.3.7.1 Documents (such as a bill of lading, cargo manifest or CMR/CIM/CMNI consignment note) associated with the carriage of vehicles or containers that have been cooled or conditioned and have not been completely ventilated before carriage shall include the following information:

- (a) The UN number preceded by the letters "UN"; and
- (b) The name indicated in Column (2) of Table A of Chapter 3.2 followed by the words "AS COOLANT" or "AS CONDITIONER" as appropriate in an official language of the country of origin and also, if that language is not English, French or German, in English, French or German, unless agreements, if any, concluded between the countries concerned in the transport operation provide otherwise.

For example: UN 1845, CARBON DIOXIDE, SOLID, AS COOLANT.

5.5.3.7.2 The transport document may be in any form, provided it contains the information required in 5.5.3.7.1. This information shall be easy to identify, legible and durable.