

## Table of contents

14 Anthropometry and biomechanics .....	14-1
14.1 General application of anthropometric and biomechanic data .....	14-2
14.1.1 User population.....	14-2
14.1.2 Using design limits .....	14-4
14.1.3 Avoiding pitfalls in applying anthropometric data .....	14-6
14.1.4 Solving a complex sequence of design problems .....	14-7
14.1.5 Use of distribution and correlation data.....	14-11
14.2 Anthropometric variability factors.....	14-13
14.3 Anthropometric and biomechanics data.....	14-13
14.3.1 Data usage.....	14-13
14.3.2 Static body characteristics.....	14-14
14.3.3 Dynamic (mobile) body characteristics .....	14-28
14.3.3.1 Range of whole body motion.....	14-28
14.3.3.2 Joint motion .....	14-29
14.4 Reach.....	14-35
14.5 Human strength and handling capacity.....	14-42
14.5.1 Muscle strength factors .....	14-42
14.5.2 Exerted forces .....	14-43
14.5.3 Push and pull forces .....	14-47
14.5.4 Lifting and carrying .....	14-52
14.6 Wheelchair anthropometrics .....	14-52
Glossary .....	14-55
References.....	14-58
Index .....	14-59

## List of exhibits

<b>Exhibit 14.1.4.4</b> Additive effects of clothing on anthropometric measures .....	14-9
<b>Exhibit 14.1.4.4 (continued)</b> Additive effects of clothing on anthropometric measures.....	14-10
<b>Exhibit 14.1.5.1</b> Percentile values.....	14-11
<b>Exhibit 14.3.2.1</b> Static human physical characteristics.....	14-15
<b>Exhibit 14.3.2.1 (continued)</b> Static human physical characteristics (head).....	14-16
<b>Exhibit 14.3.2.1 (continued)</b> Static human physical characteristics (head).....	14-17
<b>Exhibit 14.3.2.1 (continued)</b> Static human physical characteristics (head).....	14-18
<b>Exhibit 14.3.2.1 (continued)</b> Static human physical characteristics (seated) .....	14-19
<b>Exhibit 14.3.2.1 (continued)</b> Static human physical characteristics (seated) .....	14-20
<b>Exhibit 14.3.2.1 (continued)</b> Static human physical characteristics (seated) .....	14-21
<b>Exhibit 14.3.2.1 (continued)</b> Static human physical characteristics (seated) .....	14-22
<b>Exhibit 14.3.2.1 (continued)</b> Static human physical characteristics (standing).....	14-23
<b>Exhibit 14.3.2.1 (continued)</b> Static human physical characteristics (standing).....	14-24
<b>Exhibit 14.3.2.1 (continued)</b> Static human physical characteristics (standing).....	14-25
<b>Exhibit 14.3.2.1 (continued)</b> Static human physical characteristics (hand).....	14-26
<b>Exhibit 14.3.2.1 (continued)</b> Static human physical characteristics (standing position).....	14-27

<b>Exhibit 14.3.3.2.1</b> Joint movement ranges.....	14-30
<b>Exhibit 14.3.3.2.1 (continued)</b> Joint movement ranges .....	14-31
<b>Exhibit 14.3.3.2.1 (continued)</b> Joint movement ranges .....	14-32
<b>Exhibit 14.3.3.2.2</b> Change in range of joint movement with movement in an adjacent joint	14-34
<b>Exhibit 14.4.2</b> Reach envelopes in vertical and horizontal planes.....	14-36
<b>Exhibit 14.4.3 (a)</b> Touch, grip, and grasp functions .....	14-37
<b>Exhibit 14.4.3 (a) (continued)</b> Touch, grip, and grasp functions.....	14-38
<b>Exhibit 14.4.3 (b)</b> Thumb and forefinger grasp boundary data for females in the 46 cm and 61 cm horizontal planes .....	14-39
<b>Exhibit 14.4.3 (c)</b> Thumb and forefinger grasp boundary data for females in the 0 and -15 cm vertical planes .....	14-40
<b>Exhibit 14.5.2.1</b> Male muscle strength of the arm, hand, and thumb for control forces (5th percentile values) .....	14-44
<b>Exhibit 14.5.2.1 (continued)</b> Design criteria for male muscle strength of the arm, hand, and thumb for control forces (5th percentile values).....	14-45
<b>Exhibit 14.5.3.1</b> Horizontal push and pull forces that can be exerted .....	14-47
<b>Exhibit 14.5.3.2</b> Static muscle strength data for vertical pull exertions .....	14-49
<b>Exhibit 14.5.3.2 (continued)</b> Static muscle strength data for vertical pull exertions.....	14-50
<b>Exhibit 14.5.3.2 (continued)</b> Static muscle strength data for vertical pull exertions.....	14-51
<b>Exhibit 14.6.1</b> Forward reach from a wheelchair.....	14-52
<b>Exhibit 14.6.1 (continued)</b> Forward reach from a wheelchair .....	14-53
<b>Exhibit 14.6.4</b> Side reach from a wheelchair. ....	14-53
<b>Exhibit 14.6.6</b> Wheelchair dimensions. ....	14-54

## 14 Anthropometry and biomechanics

Designers and human factors specialists incorporate scientific data on human physical capabilities into the design of systems and equipment. Human physical characteristics, unlike those of machines, cannot be designed. However, failure to take into account human physical characteristics when designing systems or equipment can place unnecessary demands and restrictions upon user personnel.

**Definitions.** **Anthropometry** is the scientific measurement and collection of data about human physical characteristics and the application (engineering anthropometry) of these data in the design and evaluation of systems, equipment, manufactured products, human-made environments, and facilities. **Biomechanics** describes the mechanical characteristics of biological systems, in this case the human body, in terms of physical measures and mechanical models. This field is interdisciplinary (mainly anthropometry, mechanics, physiology, and engineering). Its applications address mechanical structure, strength, and mobility of humans for engineering purposes.

This chapter of the HFDS provides additional anthropometric and biomechanics data beyond that used in other chapters. Previous data are cross-referenced, where appropriate. Unlike the other sections, this section provides more guidance about the nature of the data, its selection, and its proper use. It provides rules for applying the vast amount of human form data available to specific design fit, function, and human task performance.

The section also covers application principles and their resulting rules, human body measurement data (static and dynamic), range of motion and strength data, as well as comfort information.

## 14.1 General application of anthropometric and biomechanics data

In this document, body size, strength, and mobility data are presented. In the future, this population will include a wider range of ethnic backgrounds and an increased number of females. The average age is expected to decrease. These changes will be important for future systems design.

In this general section, design criteria and rules are given for: (1) ascertaining user population data, (2) using the design limits approach, (3) avoiding pitfalls in applying the data, (4) using distribution and correlation data, (5) solving design problems, and (6) using models.

### 14.1.1 User population

Anthropometric data are most appropriate when they are derived from a survey of the existing worker population of interest. The FAA surveyed select static measurements from the Technical Operations worker population. These measurements are compiled in Appendix B. Since the sub-population associated with the FAA has not been surveyed other than that contained in Appendix B, information from substitute sources is used as a basis for design for all other FAA populations and measurements.

- **14.1.1.1 Use of data.** Anthropometric and biomechanics data shall be used in the design of systems, equipment (including personal protection equipment), clothing, workplaces, passageways, controls, access openings, and tools. [Source: National Aeronautics and Space Administration (NASA-STD-3000A), 1989]

**Discussion.** The human's interface with other system components needs to be treated as objectively and systematically as are other interface and hardware component designs. It is not acceptable to guess about human physical characteristics or to use the designer's own measurements or the measurements of associates. Application of appropriate anthropometric and biomechanics data is expected.

- **14.1.1.2 Data to be used.** Designers and human factors specialists shall use the anthropometric and biomechanics data provided in this document and the associated appendix. If additional data are needed, they shall use the more complete data given in DOD-HDBK-743A. If other reference or new data collections are considered, the contractor shall obtain the approval of the acquisition program office. [Source: NASA-STD-3000A, 1989; Department of Defense (DOD-HDBK-743A), 1991]

**Discussion.** If this document does not present data needed for the problem at hand, the designer will have to select appropriate sample information from DOD-HDBK-743A. In that handbook, the 1988 military male and female survey distributions can be used to represent the FAA user population when needed, as it represents the most comprehensive samples available. Note that civilian working populations could be expected to have a larger range of sizes and ages than the military. Samples with comprehensive measures are not available.

- **14.1.1.3 Using population extremes.** Designers and human factors specialists shall draw upon the extremes of the larger male population distribution and the extremes of the smaller female population distributions to represent the upper and lower range values, respectively, to apply to anthropometric and biomechanics design problems. [Source: NASA-STD-3000A, 1989]

**Discussion.** The use of separate male and female population data is a conservative approach that results in more inclusive design dimensions than the same percentiles would from a composite population.

### 14.1.2 Using design limits

Initial rules in this section address the design limits approach. To understand this approach, it is helpful to consider the overall steps and choices that one makes in applying anthropometric and biomechanics data. The design limits approach entails selecting the most appropriate percentile values in population distributions and applying the appropriate associated data in a design solution. These steps are listed in this introductory material and are explained in detail in the initial three rules of this subsection. If the reader has applied the design limit approach and understands it, the reader can skip the rest of this introductory material as well as the explanations associated with the first three rules. However the reader should not skip the rules.

**Definition.** The **design limits approach** is a method of applying population or sample statistics and data about human physical characteristics to a design so that a desired portion of the user population is accommodated by the design. The range of users accommodated is a function of limits used in setting the population portion.

To understand the design limits approach, it is helpful to consider step by step the choices that design personnel make in applying these human physical data.

- a. Select the correct human physical characteristic and its applicable measurement characteristic (description) for the design problem at hand.
- b. Select the appropriate population, representative sample, or rule information on the selected human physical characteristic and measurement description to apply to the design problem.
- c. Determine the appropriate statistical point(s), usually percentile points from rule information or from the sample distribution(s) in order to accommodate a desired range of the human characteristic within the distribution of the user population.
- d. Read directly or determine statistically the measurement value(s) that corresponds to the selected statistical point(s) relevant to the population distribution.
- e. Incorporate the measurement value as a criterion for the design dimension, or in the case of biomechanics data, for the movement or force solution in the design problem.

- **14.1.2.1 Clearance dimension at the 95th percentile.** Design clearance dimensions that must accommodate or allow passage of the body or parts of the body shall be based upon the 95th percentile of the male distribution data. [Source: Department of Defense (MIL-STD-1472D), 1989]
- **14.1.2.2 Limiting dimension at the 5th percentile.** Limiting design dimensions, such as reach distances, control movements, display and control locations, test point locations, and handrail positions that restrict or are limited by body or body part size, shall be based upon the 5th percentile of female data for applicable body dimensions. [Source: MIL-STD-1472D, 1989]

**Discussion.** For example, the maximum height from floor level to an accessible part of any piece of equipment needs to be within reach of the 5th percentile female user, which will ensure that at least 95 percent of the user population can access this part of the equipment.

- **14.1.2.3 Adjustable dimensions.** Any equipment dimensions that need to be adjusted for the comfort or performance of the individual user shall be adjustable over the range of the 5th to 95th percentiles. [Source: MIL-STD-1472D, 1989]
- **14.1.2.4 Sizing determinations.** Clothing and certain personal equipment dimensions that need to conform closely to the contour of the body or body parts shall be designed and sized to accommodate at least the 5th through the 95th percentile range. If necessary, this range shall be accommodated by creating a number of unique sizes, where each size accommodates a segment of the population distribution. Each segment can be bounded by a small range of percentile values. [Source: MIL-STD-1472D, 1989]
- **14.1.2.5 Critical life support equipment.** Dimensions or sizes of critical life support equipment shall accommodate, at least, the range defined by the 1st through the 99th percentiles of the distribution. [Source: MIL-STD-1472D, 1989]

### 14.1.3 Avoiding pitfalls in applying anthropometric data

There are several common errors to be avoided by designers when they apply anthropometric data to design. These are: (1) designing to the midpoint (50th percentile) or average, (2) the misperception of the typical sized person, (3) generalizing across human characteristics, and (4) summing of measurement values for like percentile points across adjacent body parts.

- **14.1.3.1 Misuse of the 50th percentile or of the average.** The 50th percentile or mean shall not be used as design criteria as it accommodates only half of the users. [Source: NASA-STD-3000A, 1989]

**Discussion.** When the population distribution is Gaussian (normal), the use of either the 50th percentile or the average for a clearance would, at best, accommodate half the population.

- **14.1.3.2 Misperception of the typically sized person.** Designers or human factors specialists shall not use the concept of a typically sized person where the same percentiles values are expected across many dimensions. A person at the 95 percentile in height is unlikely to measure at the 95th percentile in reach or other dimensions. A percentile value and its measurement value that pertains to a particular body part shall be used exclusively for functions that relate to that body part. [Source: Department of the Air Force (AFSC DH 1-3), 1980; NASA-STD-3000A, 1989]

**Discussion.** When the middle 30 percent of a population of 4000 men was measured on 10 dimensions, only one-fourth of them were "average" in a single dimension (height), and less than 1 percent were average in five dimensions (height, chest circumference, arm length, crotch height, and torso circumference). Keeping in mind that there is not an "average person," one also must realize that there is not a "5th percentile person" nor a "95th percentile" person. Different body part dimensions are not necessarily highly correlated. An implication is that one can not choose a person who is 95 percentile in stature as a test subject for meeting 95 percentile requirements in reach or other dimensions.



- **14.1.3.3 Summation of segment dimensions.** Summation of like percentile values for body components shall not be used to represent any human physical characteristic that appears to be a composite of component characteristics. [Source: NASA-STD-3000A, 1989]

**Discussion.** The 95th percentile arm length, for instance, is not the addition of the 95th percentile shoulder-to-elbow length plus the 95th percentile elbow-to-hand length. The actual 95th percentile arm length will be somewhat less than the erroneous summation. To determine the 95th percentile arm length, one must use a distribution of arm length rather than component part distributions.

#### 14.1.4 Solving a complex sequence of design problems

In this section, rules are presented for approaching complex design problems that require the consideration of a sequence of relevant design reference locations (such as seat reference points and eye reference zones), human physical characteristics, statistical points, and measures. The recommended approach involves identifying the necessary human activities and positions and establishing reference points and envelopes for the necessary activities. These envelopes impact the location and design of controls and displays, as well as the placement of work surfaces, equipment, and seating accommodations. The effects of clothing or carried equipment are then used to expand the dimensions.

- **14.1.4.1 Design to body positions and motions of the tasks.** Design personnel shall base the necessary operator and user body positions and motions on personnel tasks to be performed during normal, degraded, and emergency modes of operations and maintenance. [Source: NASA-STD-3000A, 1989]

- **14.1.4.2 Construction or collection of unique position data.** If the common and mobile working positions data in Chapter 10 of this document do not represent the unique working positions associated with a design, then design personnel shall construct the applicable human physical characteristics and measures from the static and dynamic data provided later in Sections 14.3.2 and 14.3.3 or in DOD-HDBK-743A. If no applicable data can be found or calculated for important design measures, then, with the prior approval of the acquisition program office, sample measures shall be taken on appropriate personnel for the unique working positions. [Source: DOD-HDBK-743A, 1991; Roebuck, Kroemer, & Thomson, 1975]

**Discussion.** Anthropometric measurement needs to be done by professionals because there are many complexities and potential interactions among positions of body segments, as well as many technical points and pitfalls to avoid in measurement practice. Sample measurement methods can be found in Roebuck, Kroemer, and Thomson, 1975.

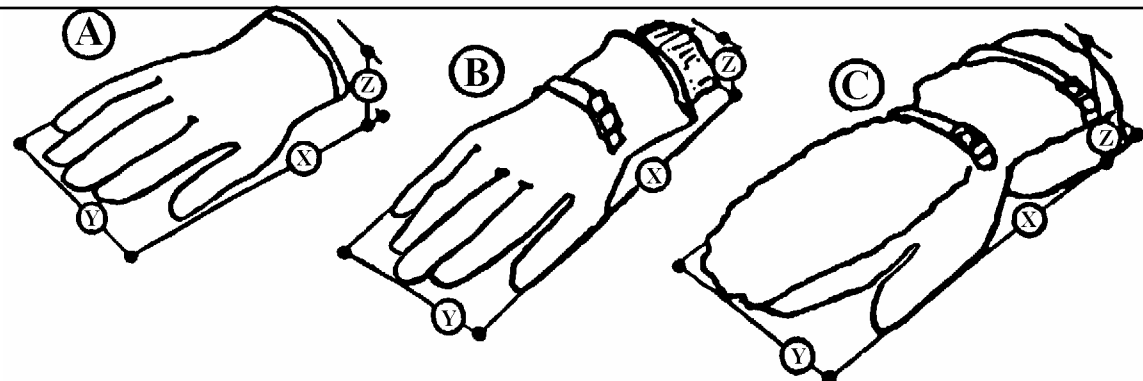
- **14.1.4.3 Building and using reach envelopes.** If reach data provided in this document (see Section 14.4) do not apply to a specific design problem, then reach design dimensions or envelopes for design use should be constructed considering:
  - a. one-handed or two-handed operation,
  - b. grasp requirements which may affect the functional reach envelope,
  - c. positional relationship of a shoulder reference point or arm rotation point to the seat back, seat reference point, or other posture reference or design reference points, and
  - d. the appropriate samples and anthropometric measurements from the data provided in this document or in DOD-HDBK-743A, 1991 (see Paragraph 14.1.1.2). [Source: DOD-HDBK-743A, 1991]

- 14.1.4.4 Effects of clothing.** Because most anthropometric data presented in this document and in other data sources represent nude body measurements (unless otherwise indicated), suitable allowances shall be made for light, medium, or heavy clothing and for any special protective equipment that is worn. Note that measurements of FAA Technical Operations Personnel contained in Appendix B represent clothed body measurements. Exhibit 14.1.4.4 illustrates the additive effects of clothing on static body dimensions and shows the 95th percentile gloved hand measures. If special items of protective clothing or equipment are involved, the effects shall be measured in positions required by the users' tasks. The effects on the extremes of the population distribution shall be determined. [Source: Department of Defense (MIL-HDBK-759B), 1992; Johnson, 1984]

**Discussion.** Nude dimension and light clothing can be regarded as synonymous for practical purposes. Additional information on the changes in anthropometric measurement values imposed by different clothing ensembles is found in Johnson, 1984.

**Exhibit 14.1.4.4** Additive effects of clothing on anthropometric measures

	<b>Light clothing</b>	<b>Medium clothing</b>	<b>Heavy clothing</b>
Abdomen depth	2.39 cm (0.94 in)	3.00 cm (1.18 in)	6.45 cm (2.54 in)
Buttock-knee length	0.51 cm (0.20 in)	0.76 cm (0.30 in)	1.78 cm (0.70 in)
Chest depth	1.04 cm (0.41 in)	2.44 cm (0.96 in)	3.91 cm (1.54 in)
Elbow breadth	1.42 cm (0.56 in)	2.64 cm (1.04 in)	5.38 cm (2.12 in)
Hip breadth	1.42 cm (0.56 in)	1.93 cm (0.76 in)	3.56 cm (1.40 in)
Hip breadth, sitting	1.42 cm (0.56 in)	1.93 cm (0.76 in)	3.56 cm (1.40 in)
Knee breadth (both)	1.22 cm (0.48 in)	1.22 cm (0.48 in)	4.27 cm (1.68 in)
Knee height, sitting	3.35 cm (1.32 in)	3.35 cm (1.32 in)	3.66 cm (1.44 in)
Shoulder breadth	0.61 cm (0.24 in)	2.24 cm (0.88 in)	2.95 cm (1.16 in)
Shoulder-elbow length	0.36 cm (0.14 in)	1.27 cm (0.50 in)	1.57 cm (0.62 in)
Shoulder height, sitting	0.41 cm (0.16 in)	1.47 cm (0.58 in)	2.03 cm (0.80 in)

**Exhibit 14.1.4.4 (continued)** Additive effects of clothing on anthropometric measures


Hand position	A Anti-contact glove			B Wet-cold glove			C Arctic glove		
	X	Y	Z	X	Y	Z	X	Y	Z
Extended flat cm (in)	26.7 (10.5)	11.9 (4.7)	6.4 (2.5)	27.2 (10.7)	14.5 (5.7)	7.6 (3.0)	42.2 (16.6)	13.7 (5.4)	9.1 (3.6)
Closed as fist cm (in)	17.8 (7.0)	12.7 (5.0)	8.4 (3.3)	18.5 (7.3)	14.7 (5.8)	9.4 (3.7)	36.3 (14.3)	13.2 (5.2)	13.7 (5.4)
Grasping handle									
0.6 cm (0.24 in) diameter	17.8 (7.0)	12.7 (5.0)	8.9 (3.5)	18.5 (7.3)	14.0 (5.5)	8.9 (3.5)	35.6 (14.0)	14.0 (5.5)	11.4 (4.5)
2.5 cm (1.0 in) diameter	17.8 (7.0)	12.7 (5.0)	8.9 (3.5)	18.5 (7.3)	13.5 (5.3)	10.2 (4.0)	35.6 (14.0)	13.2 (5.2)	11.4 (4.5)
5.0 cm (2.0 in) diameter	19.0 (7.5)	11.4 (4.5)	10.7 (4.2)	20.3 (8.0)	11.9 (4.7)	10.2 (4.0)	38.1 (15.0)	13.7 (5.4)	12.7 (5.0)
Grasping knob									
0.6 cm (0.24 in) diameter	20.3 (8.0)	9.7 (3.8)	10.9 (4.3)	22.9 (9.0)	11.7 (4.6)	10.2 (4.0)	39.4 (15.5)	12.2 (4.8)	11.4 (4.5)
2.5 cm (1.0 in) diameter	22.8 (9.0)	8.9 (3.5)	10.2 (4.0)	22.9 (9.0)	11.4 (4.5)	10.2 (4.0)	40.1 (15.8)	12.2 (4.8)	12.2 (4.8)
5.0 cm (2.0 in) diameter	24.1 (9.5)	9.4 (3.7)	9.4 (3.7)	23.4 (9.2)	11.4 (4.5)	10.7 (4.1)	40.5 (15.9)	11.9 (4.7)	12.2 (4.8)

### 14.1.5 Use of distribution and correlation data

Complex uses of statistical data concerning human physical dimensions or capabilities are introduced in this section. Data and distribution information on a single physical characteristic and its measures provides no information about that characteristic's composite relationship with any other characteristic and its measures. For design, the relationship between two or more characteristics and how their measures vary together is important. Consider sizing clothing and designing seats. Bivariate distributions and correlation statistics can be used by knowledgeable professionals to determine design criteria.

- **14.1.5.1 Gaussian distribution of measurement values on a single human physical characteristic.** The relationship between the Gaussian distribution and the measurement value equivalent to the desired percentile statistic value should best be determined from a smoothed frequency distribution or from the formula presented in Exhibit 14.1.5.1 if the following conditions are met:
  - a. the percentile value is not given in applicable Human-machine-interface data, and
  - b. the population distribution for the applicable human physical characteristic is known to be Gaussian (normal) and the mean and variance are known. [Source: Israelski, 1977]

#### Exhibit 14.1.5.1 Percentile values

Percentile		Formula*
+	-	(SD)
70	and 30	%tile = $X \pm (0.524)(X)$
75	and 25	%tile = $X \pm (0.674)(X)$
80	and 20	%tile = $X \pm (0.842)(X)$
85	and 15	%tile = $X \pm (1.036)(X)$
90	and 10	%tile = $X \pm (1.282)(X)$
95	and 5	%tile = $X \pm (1.645)(X)$
97.5	and 2.5	%tile = $X \pm (1.960)(X)$
99	and 1	%tile = $X \pm (2.326)(X)$
99.5	and 0.5	%tile = $X \pm (2.576)(X)$

SD = (Standard deviation) X = mean or 50th percentile  
 \* Do not use with skewed strength data.

- **14.1.5.2 Using bivariate distribution data.** Bivariate data should be professionally applied and interpreted since knowledge of the population distribution characteristics are necessary to project and extract design limits and to apply them to design problems. [Source: MIL-HDBK-759B, 1992]

**Discussion.** The variability of two body measurements and their interrelationship with each other may be presented in a graph or a table. Bivariate information includes the ranges of two measurements and the percentages or frequencies of individuals who are characterized by the various possible combinations of values of the two measurements. Knowledgeable professionals can tell about the relationships from the appearance and shape of the joint distribution of measures. Correlation statistics, when the relationship warrants, provide additional insight, and when appropriate samples are large enough, may provide predictions of population values.

- **14.1.5.3 Use of correlation and multiple correlation data.** When two or more human physical characteristics are applicable to a design problem, professionals should apply and interpret correlation statistics. Knowledge about distributions and intercorrelations among the distributions need to be factored into the use of these data. [Source: MIL-HDBK-759B, 1992; Kroemer, Kroemer, & Kroemer-Elbert 1990]

**Discussion.** The relationships or correlations between specific body measurements are highly variable among the various human characteristics and may differ across samples and populations. For example, breadth measurements tend to be more highly correlated with weight than with stature. The degree of the relationship may be expressed by a correlation coefficient or "r" value.

Although common percentile values may not be used to sum data across adjacent body parts, (see Paragraph 14.1.3.3), regression equations derived from the applicable samples can be used in constructing composite body measures.

**Definition.** The **correlation coefficient or "r" value** describes the degree to which two variables vary together (positive correlation) or vary inversely (negative correlation). The correlation coefficient, "r", has a range of values from +1.0 (perfect positive correlation) through -1.0 (perfect negative correlation). Multiple correlation involves the predictable relationship of two or more variables with another criterion variable (such as a composite measurement value). **"R"** is the **multiple correlation coefficient**. It is recommended that only correlations with strong predictive values be used (that is where r or R is at least or greater than |.7|). (Note:  $R^2$  is the square of the multiple correlation coefficient and equates to the proportion of the variation accounted for in

the prediction. An R of .7 would account for about 50 percent of the variation).

## 14.2 Anthropometric variability factors

There are many factors that relate to the large variability observed in measures of the human body. These factors include: (1) body position, (2) age, health, and body condition, (3) sex, (4) race and national origin, (5) occupation, and (6) evolutionary trends. These factors affect future population sampling and encourage the use of the most recent data on the populations of interest. If designers and human factors specialists need to draw upon other data or accomplish some special purpose sampling, the following rules related to data variability may assist.

- **14.2.1 Foreign populations.** If a specific use of the system or equipment involves operation or maintenance by foreign personnel in locations outside the United States, sample data should be obtained that represents the foreign work force. [Source: Israelski, 1977]
- **14.2.2 Body slump.** In determining body position and eye position zones for seated or standing positions, a slump factor which accompanies relaxation should be taken into account. Seated-eye height measurements can be reduced by as much as 65 mm (2.56 in) when a person sits in a relaxed position. Body slump, when standing, reduces stature as much as 19 mm (.75 in) from a perfectly erect position. These slump factors should be considered in designing adjustable seats, visual envelopes, and display locations. [Source: Israelski, 1977]

## 14.3 Anthropometric and biomechanics data

This section provides general guidance for the use of specific anthropometric and biomechanics data, static body characteristics data, dynamic body characteristic data, including range of joint motion and common and mobile working positions.

Dimensions of the human body which influence the design of personal and operational equipment are of two types: (1) static dimensions, which are measurements of the head, torso, and limbs in normal positions, and (2) dynamic dimensions, which are measurements taken in working positions or during movement. [Source: AFSC DH 1-3, 1980; NASA-STD-3000A, 1989]

### 14.3.1 Data usage

- **14.3.1.1 Use of anthropometric and biomechanics data.** Data throughout Section 14.3 and the associated appendix are to be used for anthropometric issues that are not addressed in earlier sections of this document. If designers and human factors specialists need additional data to solve anthropometric design problems associated with human physical characteristics, they

shall use the data presented in DOD-HDBK-743A (see also 14.1.1.2). [Source: DOD-HDBK-743A, 1991]

- **14.3.1.2 Task considerations.** Designers and human factors specialists shall take the following task conditions into consideration when using the human physical characteristic data presented in this section:
  - a. the nature, frequency, and difficulty of the related tasks to be performed by the operator or user of the equipment,
  - b. the position of the body during performance of operations and maintenance tasks,
  - c. mobility and flexibility demands imposed by maintenance tasks,
  - d. the touch, grasp, torque, lift, and carry requirements of the tasks,
  - e. increments in the design-critical dimensions imposed by clothing or equipment, packages, and tools, and
  - f. increments in the design-critical dimensions imposed by the need to compensate for obstacles and projections. [Source: MIL-HDBK-759B, 1992; MIL-STD-1472D, 1989]

### 14.3.2 Static body characteristics

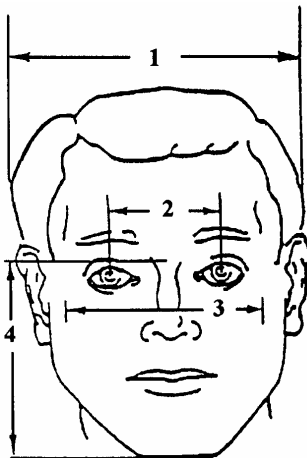
- **14.3.2.1 Static data.** Exhibit 14.3.2.1 presents static human physical characteristics and measurement values which should be used, as applicable, in design problems. Exhibit 14.3.2.1 addresses the following body parts: head, seated body, standing body, and hands. [Source: DOD-HDBK-743A, 1991]
- **14.3.2.2 Static data for Technical Operations Personnel.** Appendix B presents static human physical characteristics and measurement values that should be used, as applicable, in the design of equipment to be used by Technical Operations personnel. [Source: Bradtmiller, B., Hodge, B., Kristensen, S., & Mucher, M., 2008]



**Exhibit 14.3.2.1** Static human physical characteristics

- 1 Head Breadth.** The maximum breadth of the head, usually above and behind the ears.

			Percentiles				
Sample			1st	5th	50th	95th	99th
A	Men	cm	13.9	14.3	15.2	16.1	16.5
		(in)	(5.5)	(5.6)	(6.0)	(6.3)	(6.5)
B	Women	cm	13.3	13.7	14.4	15.3	15.7
		(in)	(5.2)	(5.4)	(5.7)	(6.0)	(6.2)



- 2 Interpupillary Breadth.** The distance between the centers of the pupils of the eyes (as the eyes are looking straight ahead).

			Percentiles				
Sample			1st	5th	50th	95th	99th
A	Men	cm	5.7	5.9	6.5	7.1	7.4
		(in)	(2.2)	(2.3)	(2.6)	(2.8)	(2.9)
B	Women	cm	5.5	5.7	6.2	6.9	7.1
		(in)	(2.2)	(2.2)	(2.4)	(2.7)	(2.8)

- 3 Face Breadth (bizygomatic).** The breadth of the face, measured across the most lateral projections of the cheek bones (zygomatic arches).

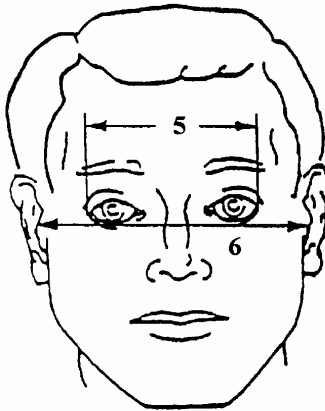
			Percentiles				
Sample			1st	5th	50th	95th	99th
A	Men	cm	12.8	13.2	14.0	15.0	15.4
		(in)	(5.0)	(5.2)	(5.5)	(5.9)	(6.1)
B	Women	cm	12.1	12.3	13.1	14.0	14.4
		(in)	(4.8)	(4.8)	(5.2)	(5.5)	(5.7)

- 4 Face Length (menton-sellion).** The vertical distance from the tip of the chin (menton) to the deepest point on the nasal root depression between the eyes (sellion).

			Percentiles				
Sample			1st	5th	50th	95th	99th
A	Men	cm	10.8	11.2	12.2	13.3	13.7
		(in)	(4.3)	(4.4)	(4.8)	(5.2)	(5.4)
B	Women	cm	10.1	10.4	11.3	12.4	12.9
		(in)	(4.0)	(4.1)	(4.4)	(4.9)	(5.1)

**Exhibit 14.3.2.1 (continued)** Static human physical characteristics (head)

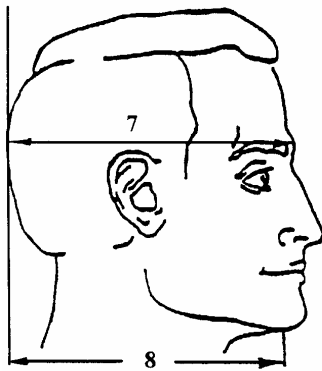
- 5 Biocular Breadth.** The distance from the outer corners of the eyes (right and left ectocanthi).



			Percentiles				
Sample			1st	5th	50th	95th	99th
A	Men	cm	11.0	11.3	12.2	13.1	13.6
		(in)	(4.3)	(4.4)	(4.8)	(5.2)	(5.4)
B	Women	cm	10.8	11.1	11.6	12.9	13.3
		(in)	(4.3)	(4.4)	(4.6)	(5.1)	(5.2)

- 6 Bitrignon Breadth.** The breadth of the head from the right trignon to the left. (Trignon is the cartilaginous notch at the front of the ear).

			Percentiles				
Sample			1st	5th	50th	95th	99th
A	Men	cm	13.1	13.5	14.5	15.5	15.9
		(in)	(5.2)	(5.3)	(5.7)	(6.1)	(6.3)
B	Women	cm	12.5	12.8	13.3	14.3	15.0
		(in)	(4.9)	(5.0)	(5.2)	(5.6)	(5.9)



- 7 Glabella to Back of Head.** The horizontal distance from the most anterior point of the forehead between the brow-ridges (glabella) to the back of the head, measured with a headboard.

			Percentiles				
Sample			1st	5th	50th	95th	99th
A	Men	cm	18.3	18.8	20.0	21.1	21.7
		(in)	(7.2)	(7.4)	(7.9)	(8.3)	(8.5)
B	Women	cm	17.5	18.0	19.1	20.2	20.7
		(in)	(6.9)	(7.1)	(7.5)	(8.0)	(8.1)

- 8 Menton to Back of Head.** The horizontal distance from the tip of the chin (menton) to the back of the head, measured with a headboard.

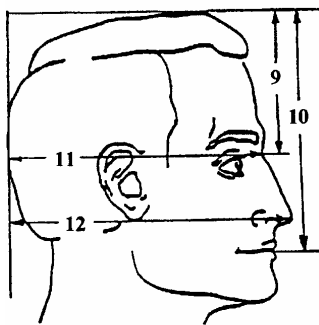
			Percentiles				
Sample			1st	5th	50th	95th	99th
A	Men	cm	15.7	16.5	18.2	20.0	20.7
		(in)	(6.2)	(6.5)	(7.2)	(7.9)	(8.1)
B	Women	cm	15.2	15.8	17.3	18.9	19.6
		(in)	(6.0)	(6.2)	(6.8)	(7.4)	(7.7)

**Exhibit 14.3.2.1 (continued) Static human physical characteristics (head)**

- 9 Sellion to Top of Head.** The vertical distance from the nasal root depression between the eyes (sellion) to the level of the top of the head, measured with a headboard.

			Percentiles				
Sample			1st	5th	50th	95th	99th
A	Men	cm	9.7	10.1	11.2	12.4	12.9
		(in)	(3.8)	(4.0)	(4.4)	(4.9)	(5.1)
B	Women	cm	9.0	9.5	10.5	11.7	12.2
		(in)	(3.5)	(3.7)	(4.1)	(4.6)	(4.8)

- 10 Stomion to Top of Head.** The vertical distance from the midpoint of the lips (stomion) to the level of the top of the head, measured with a headboard.



			Percentiles				
Sample			1st	5th	50th	95th	99th
A	Men	cm	16.9	17.4	18.6	19.9	20.6
		(in)	(6.7)	(6.9)	(7.3)	(7.8)	(8.1)
B	Women	cm	15.7	16.3	17.5	18.8	19.4
		(in)	(6.2)	(6.4)	(6.9)	(7.4)	(7.6)

- 11 Sellion to Back of Head.** The horizontal distance from the nasal root depression between the eyes (sellion) to the back of the head, measured with a headboard.

			Percentiles				
Sample			1st	5th	50th	95th	99th
A	Men	cm	18.0	18.5	19.7	20.9	21.4
		(in)	(7.1)	(7.3)	(7.8)	(8.2)	(8.4)
B	Women	cm	17.4	17.8	18.9	20.0	20.5
		(in)	(6.9)	(7.0)	(7.4)	(7.9)	(8.1)

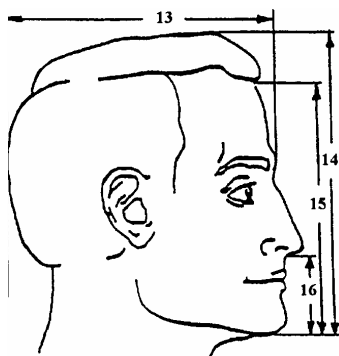
- 12 Pronasale to Back of Head.** The horizontal distance from the tip of the nose (pronasale) to the back of the head, measured with a headboard.

			Percentiles				
Sample			1st	5th	50th	95th	99th
A	Men	cm	20.0	20.5	22.0	23.2	23.9
		(in)	(7.9)	(8.1)	(8.7)	(9.1)	(9.4)
B	Women	cm	19.2	19.7	21.0	22.2	22.8
		(in)	(7.6)	(7.8)	(8.3)	(8.7)	(9.0)

**Exhibit 14.3.2.1 (continued) Static human physical characteristics (head)**

- 13 Head Length.** The maximum length of the head; measured from the most anterior point of the forehead between the brow-ridges (glabella) to the back of the head (occiput).

			Percentiles				
Sample			1st	5th	50th	95th	99th
A	Men	cm	18.0	18.5	19.7	20.9	21.3
		(in)	(7.1)	(7.3)	(7.8)	(8.2)	(8.4)
B	Women	cm	17.2	17.6	18.7	19.8	20.2
		(in)	(6.8)	(6.9)	(7.4)	(7.8)	(8.0)



- 14 Menton to Top of Head.** The vertical distance from the tip of the chin (menton) to the level of the top of the head, measured with a headboard.

			Percentiles				
Sample			1st	5th	50th	95th	99th
A	Men	cm	21.2	21.8	23.2	24.7	25.5
		(in)	(8.3)	(8.6)	(9.1)	(9.7)	(10.0)
B	Women	cm	19.8	20.4	21.8	23.2	23.8
		(in)	(7.8)	(8.0)	(8.6)	(9.1)	(9.4)

- 15 Menton-crinion Length.** The vertical distance from the bottom of the chin (menton) to the midpoint of the hairline (crinion).

			Percentiles				
Sample			1st	5th	50th	95th	99th
A	Men	cm	16.6	17.4	19.1	20.9	21.6
		(in)	(6.5)	(6.9)	(7.5)	(8.2)	(8.5)
B	Women	cm	15.5	16.1	17.7	19.2	19.9
		(in)	(6.1)	(6.3)	(7.0)	(7.6)	(7.8)

- 16 Menton-subnasale Length.** The distance from the bottom of the chin (menton) to the base of the nasal septum (subnasale).

			Percentiles				
Sample			1st	5th	50th	95th	99th
Men	cm	6.1	6.5	7.3	8.3	8.7	
	(in)	(2.4)	(2.6)	(2.9)	(3.3)	(3.4)	
Women	cm	5.7	6.0	6.9	7.8	8.3	
	(in)	(2.2)	(2.4)	(2.7)	(3.1)	(3.3)	

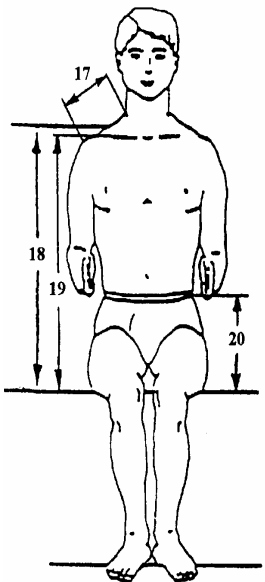
**Exhibit 14.3.2.1 (continued) Static human physical characteristics (seated)**

**17 Shoulder Length.** The surface distance along the top of the shoulder from the junction of the neck and shoulder to the point of the shoulder (acromion).

			Percentiles				
Sample			1st	5th	50th	95th	99th
A	Men	cm	12.4	13.3	15.0	16.9	17.7
		(in)	(4.9)	(5.2)	(5.9)	(6.7)	(7.0)
B	Women	cm	12.0	12.7	14.5	16.2	17.1
		(in)	(4.7)	(5.0)	(5.7)	(6.4)	(6.7)

**18 Mid-shoulder Height, Sitting.** The vertical distance from the sitting surface of the shoulder halfway between the neck and the point of the shoulder, measured with the subject sitting.

			Percentiles				
Sample			1st	5th	50th	95th	99th
A	Men	cm	56.3	58.3	63.0	67.7	69.4
		(in)	(22.2)	(23.0)	(24.8)	(26.7)	(27.3)
B	Women	cm	52.3	53.9	58.4	63.1	64.7
		(in)	(20.6)	(21.2)	(23.0)	(24.8)	(25.5)

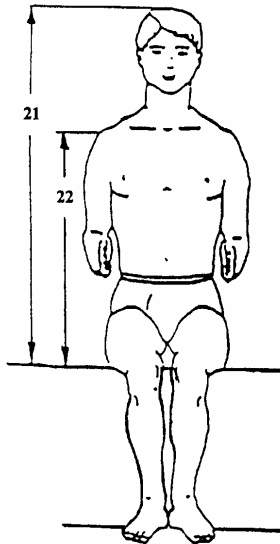


**19 Trunk (Suprasternale) Height, Sitting.** The vertical distance from the sitting surface to the lowest point of the notch in the upper edge of the breast bone (suprasternale), measured with the subject sitting.

			Percentiles				
Sample			1st	5th	50th	95th	99th
A	Men	cm	53.1	55.2	59.6	64.2	65.9
		(in)	(20.9)	(21.7)	(23.5)	(25.3)	(25.9)
B	Women	cm	49.8	51.1	55.3	59.6	61.2
		(in)	(19.6)	(20.1)	(21.8)	(23.5)	(24.1)

**20 Waist Height, Sitting.** The vertical distance from the sitting surface to the level of the waist (natural indentation), measured with the subject sitting.

			Percentiles				
Sample			1st	5th	50th	95th	99th
A	Men	cm	24.8	26.0	28.7	31.5	32.9
		(in)	(9.8)	(10.2)	(11.3)	(12.4)	(13.0)
B	Women	cm	22.8	24.4	28.0	31.5	32.7
		(in)	(9.0)	(9.6)	(11.0)	(12.4)	(12.9)

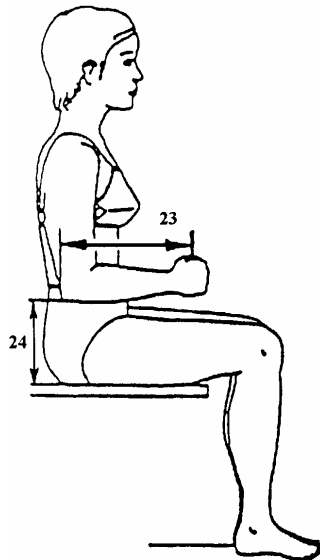
**Exhibit 14.3.2.1 (continued) Static human physical characteristics (seated)**

- 21 Sitting Height.** The vertical distance from the sitting surface to the top of the head, measured with the subject sitting. \*\* For Technical Operations Specialists, use # 17 in Appendix B.

			Percentiles				
Sample			1st	5th	50th	95th	99th
A	Men	cm	82.2	85.5	91.4	97.2	99.1
		(in)	(32.4)	(33.7)	(36.0)	(38.3)	(39.0)
B	Women	cm	77.5	79.5	85.1	91.0	93.3
		(in)	(30.5)	(31.3)	(33.5)	(35.8)	(36.7)

- 22 Shoulder (Acromiale) Height, Sitting.** The vertical distance from the sitting surface to the point of the shoulder (acromion), measured with the subject sitting.

			Percentiles				
Sample			1st	5th	50th	95th	99th
A	Men	cm	52.2	54.9	59.8	64.6	66.5
		(in)	(20.6)	(21.6)	(23.5)	(25.4)	(26.2)
B	Women	cm	49.2	50.9	55.5	60.4	62.3
		(in)	(19.4)	(20.0)	(21.9)	(23.8)	(24.5)



- 23 Elbow-grip Length.** The horizontal distance from the back of the elbow to the center of the clenched fist. \*\*For Technical Operations Specialists, use # 10 in Appendix B.

			Percentiles				
Sample			1st	5th	50th	95th	99th
A	Men	cm	32.3	33.2	35.9	39.1	40.3
		(in)	(12.7)	(13.1)	(14.1)	(15.4)	(15.9)
B	Women	cm	28.9	30.0	32.8	35.8	37.2
		(in)	(11.4)	(11.8)	(12.9)	(14.1)	(14.6)

- 24 Elbow Rest Height.** The vertical distance from the sitting surface to the bottom of the tip of the elbow, measured with the subject sitting and the forearm held horizontally. \*\*For Technical Operations Specialists, use # 19 in Appendix B.

			Percentiles				
Sample			1st	5th	50th	95th	99th
A	Men	cm	16.8	18.4	23.2	27.4	29.2
		(in)	(6.6)	(7.2)	(9.1)	(10.8)	(11.5)
B	Women	cm	15.8	17.6	22.1	26.4	28.2
		(in)	(6.2)	(6.9)	(8.7)	(10.4)	(11.1)

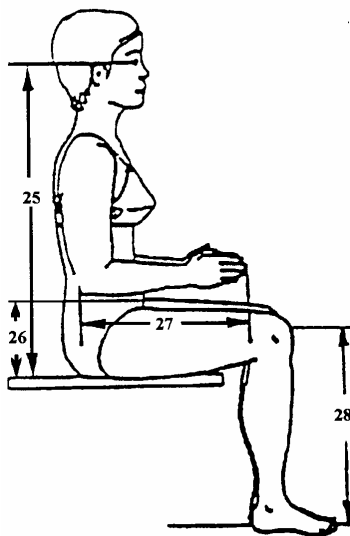
**Exhibit 14.3.2.1 (continued) Static human physical characteristics (seated)**

**25 Eye Height, Sitting.** The vertical distance from the sitting surface to the outer corner of the eye (ectocanthus), measured with the subject sitting. \*\*For Technical Operations Specialists, use # 18 in Appendix B.

		Percentiles					
Sample		1st	5th	50th	95th	99th	
A	Men	cm (in)	71.2 (28.0)	73.5 (28.9)	79.2 (31.2)	84.8 (33.4)	86.9 (34.2)
B	Women	cm (in)	66.4 (26.1)	68.5 (27.0)	73.8 (29.1)	79.4 (31.3)	81.6 (32.1)

**26 Thigh Clearance.** The vertical distance from the sitting surface to the highest point of the thigh, measured with the subject sitting. \*\*For Technical Operations Specialists, use # 21 in Appendix B.

		Percentiles					
Sample		1st	5th	50th	95th	99th	
A	Men	cm (in)	14.1 (5.6)	14.9 (5.9)	16.8 (6.6)	19.0 (7.5)	20.1 (7.9)
B	Women	cm (in)	13.4 (5.3)	14.0 (5.5)	15.8 (6.2)	18.0 (7.1)	19.0 (7.5)

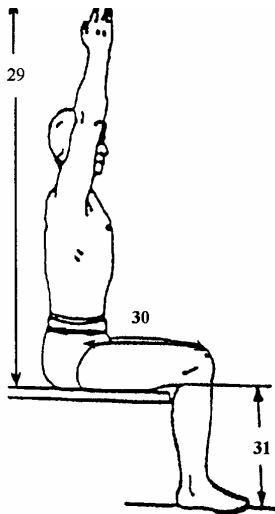


**27 Elbow-Fingertip Length.** The horizontal distance from the back of the elbow to the tip of the middle finger, with the hand extended. \*\*For Technical Operations Specialists, use # 9 in Appendix B.

		Percentiles					
Sample		1st	5th	50th	95th	99th	
A	Men	cm (in)	43.4 (17.1)	44.8 (17.6)	48.3 (19.0)	52.4 (20.6)	54.2 (21.3)
B	Women	cm (in)	39.1 (15.4)	40.6 (16.0)	44.2 (17.4)	48.3 (19.0)	49.8 (19.6)

**28 Knee Height, Sitting.** The vertical distance from the footrest surface to the top of the knee, measured with the subject sitting. \*\*For Technical Operations Specialists, use # 22 in Appendix B.

		Percentiles					
Sample		1st	5th	50th	95th	99th	
A	Men	cm (in)	49.7 (19.6)	51.4 (20.2)	55.8 (22.0)	60.6 (23.9)	62.3 (24.5)
B	Women	cm (in)	45.5 (17.9)	47.4 (18.7)	51.4 (20.2)	56.0 (22.0)	57.8 (22.8)

**Exhibit 14.3.2.1 (continued) Static human physical characteristics (seated)**

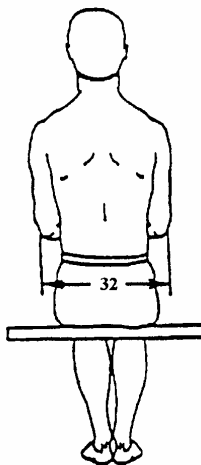
- 29 Vertical Reach, Sitting.** The vertical distance from the sitting surface to the tip of the middle finger, measured with the subject sitting and the arm, hand, and fingers extended vertically.

			Percentiles				
Sample			1st	5th	50th	95th	99th
A	Men	cm	129.3	133.8	143.3	153.2	156.7
		(in)	(50.9)	(52.7)	(56.4)	(60.3)	(61.7)
B	Women	cm	119.7	123.3	132.7	141.8	145.4
		(in)	(47.1)	(48.5)	(52.2)	(55.8)	(57.2)

- 30 Abdominal Depth, Sitting.** The depth of the abdomen, with the subject sitting.

			Percentiles				
Sample			1st	5th	50th	95th	99th
A	Men	cm	18.6	19.9	23.6	29.1	31.4
		(in)	(7.3)	(7.8)	(9.3)	(11.5)	(12.4)
B	Women	cm	17.3	18.5	21.9	27.1	29.5
		(in)	(6.8)	(7.3)	(8.6)	(10.7)	(11.6)

- 31 Popliteal Height, Sitting.** The vertical distance from the footrest surface to the underside of the lower leg, measured with the subject sitting.



			Percentiles				
Sample			1st	5th	50th	95th	99th
A	Men	cm	37.8	39.5	43.3	47.6	49.5
		(in)	(14.9)	(15.6)	(17.0)	(18.7)	(19.5)
B	Women	cm	33.7	35.1	38.9	42.9	44.6
		(in)	(13.3)	(13.8)	(15.3)	(16.9)	(17.6)

- 32 Forearm-Forearm Breadth, Sitting.** The horizontal distance across the body between the outer surfaces of the forearms, measured with the forearms flexed and held against the body.

			Percentiles				
Sample			1st	5th	50th	95th	99th
A	Men	cm	45.1	47.7	54.5	62.1	65.3
		(in)	(17.8)	(18.8)	(21.5)	(24.4)	(25.7)
B	Women	cm	39.4	41.5	46.7	52.8	56.0
		(in)	(15.5)	(16.3)	(18.4)	(20.8)	(22.0)

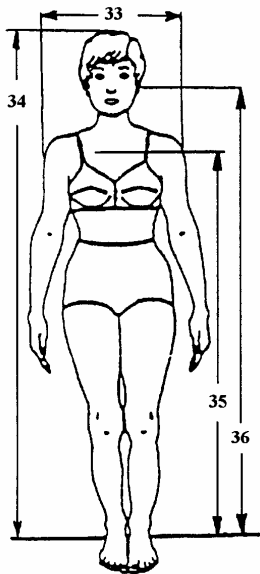


**Exhibit 14.3.2.1 (continued) Static human physical characteristics (standing)**

**33 Shoulder (Bideltoïd) Breadth.** The horizontal distance across the upper arms between the maximum bulges of the deltoid muscles; the arms are hanging and relaxed.

		Percentiles					
Sample		1st	5th	50th	95th	99th	
A	Men	cm (in)	43.4 (17.1)	45.0 (17.7)	49.1 (19.3)	53.5 (21.2)	55.2 (21.7)
B	Women	cm (in)	38.0 (15.0)	39.7 (15.6)	43.1 (17.0)	47.2 (18.6)	49.2 (19.4)

**34 Stature.** The vertical distance from the floor to the top of the head.  
 \*\*For Technical Operations Specialists, use # 5 in Appendix B.



		Percentiles					
Sample		1st	5th	50th	95th	99th	
A	Men	cm (in)	160.3 (63.1)	164.7 (64.8)	175.5 (69.1)	186.7 (73.5)	190.9 (75.2)
B	Women	cm (in)	148.3 (58.4)	152.8 (60.2)	162.7 (64.1)	173.7 (68.4)	178.0 (70.1)

**35 Suprasternale Height.** The vertical distance from the floor to the lowest point of the notch in the upper edge of the breast bone (suprasternale).

		Percentiles					
Sample		1st	5th	50th	95th	99th	
A	Men	cm (in)	130.2 (51.3)	134.3 (52.9)	143.7 (56.6)	153.7 (60.5)	157.5 (62.0)
B	Women	cm (in)	120.7 (47.5)	124.1 (48.9)	132.9 (52.3)	142.5 (56.1)	146.4 (57.6)

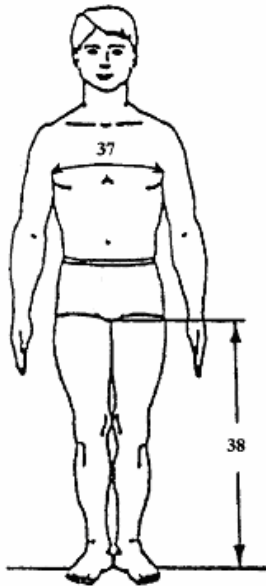
**36 Tragion Height, Standing.** The vertical distance from the floor to the tragion, the cartilaginous notch at the front of the ear.

		Percentiles					
Sample		1st	5th	50th	95th	99th	
A	Men	cm (in)	147.4 (58.0)	151.9 (59.8)	162.4 (63.9)	173.4 (68.3)	177.5 (69.9)
B	Women	cm (in)	136.3 (53.7)	140.7 (55.4)	150.4 (59.2)	161.2 (63.5)	165.4 (65.1)

**Exhibit 14.3.2.1 (continued) Static human physical characteristics (standing)**

**37 Chest (Bust) Circumference.** The circumference of the torso measured at the level of the nipples.

		Percentiles					
Sample		1st	5th	50th	95th	99th	
A	Men	cm	84.5	88.6	98.7	111.3	116.8
		(in)	(33.3)	(34.9)	(38.9)	(43.8)	(46.0)
B	Women	cm	78.1	81.4	90.1	102.2	107.7
		(in)	(30.7)	(32.0)	(35.5)	(40.2)	(42.4)

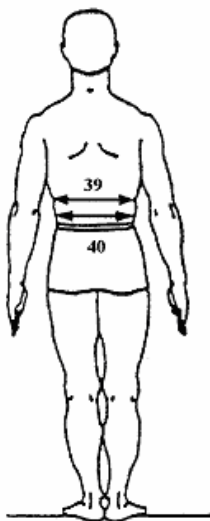


**38 Crotch Height.** The vertical distance from the floor to the midpoint of the crotch.

		Percentiles					
Sample		1st	5th	50th	95th	99th	
A	Men	cm	73.2	76.4	83.5	91.6	94.6
		(in)	(28.8)	(30.1)	(32.9)	(36.1)	(37.2)
B	Women	cm	67.0	70.0	77.0	84.6	88.1
		(in)	(26.4)	(27.6)	(30.3)	(33.3)	(34.7)

**39 Waist Circumference (Natural Indentation).** The horizontal circumference of the torso at the level of the natural indentation of the waist.

		Percentiles					
Sample		1st	5th	50th	95th	99th	
A	Men	cm	69.9	73.0	83.4	97.1	102.9
		(in)	(27.5)	(28.7)	(32.8)	(38.2)	(40.5)
B	Women	cm	60.7	63.7	71.7	84.3	91.0
		(in)	(23.9)	(25.1)	(28.2)	(33.2)	(35.8)

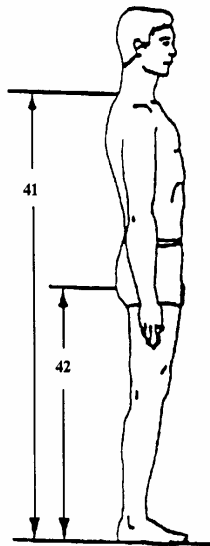


**40 Waist Circumference (Omphalion).** The horizontal circumference of the torso at the level of the navel (omphalion).

		Percentiles					
Sample		1st	5th	50th	95th	99th	
A	Men	cm	70.0	73.3	85.6	101.6	107.7
		(in)	(27.6)	(28.9)	(33.7)	(40.0)	(42.4)
B	Women	cm	64.4	67.6	78.1	94.6	102.6
		(in)	(25.4)	(26.6)	(30.7)	(37.2)	(40.4)

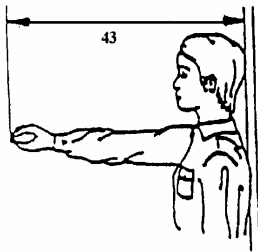
**Exhibit 14.3.2.1 (continued) Static human physical characteristics (standing)**

**41 Cervicale Height.** The vertical distance from the floor to the cervicale, the tip of the spine at the seventh cervical vertebra at the base of the neck.



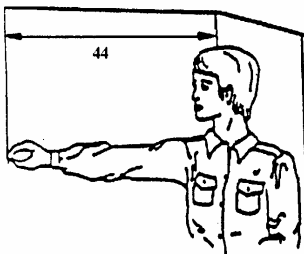
Sample	Percentiles					
	1st	5th	50th	95th	99th	
A Men	cm 137.4 (in) (54.1)	141.8 (55.8)	151.8 (59.8)	162.4 (63.9)	166.1 (65.4)	
B Women	cm 127.3 (in) (50.1)	131.4 (51.7)	140.6 (55.4)	150.8 (59.4)	154.8 (60.9)	

**42 Buttock Height.** The vertical distance from the floor to the maximum posterior protrusion of the buttock.



Sample	Percentiles					
	1st	5th	50th	95th	99th	
A Men	cm 78.4 (in) (30.9)	81.5 (32.1)	88.5 (34.8)	96.9 (38.1)	100.5 (39.6)	
B Women	cm 73.9 (in) (29.1)	76.7 (30.2)	83.7 (33.0)	91.5 (36.0)	94.9 (37.4)	

**43 Functional (Thumb-Tip) Reach.** The horizontal distance from the wall to the tip of the thumb, measured with the subject's shoulders against the wall, the arm extended forward, and the index finger touching the tip of the thumb.



Sample	Percentiles					
	1st	5th	50th	95th	99th	
A Men	cm 72.0 (in) (28.3)	73.9 (29.1)	80.0 (31.5)	86.7 (34.1)	89.7 (35.3)	
B Women	cm 65.8 (in) (25.9)	67.7 (26.7)	73.4 (28.9)	79.7 (31.4)	82.4 (32.4)	

**44 Functional (Thumb-Tip) Reach, Extended.** Measured similarly to functional (thumb-tip) reach, except that the right shoulder is extended forward as far as possible, while the left shoulder is kept pressed firmly against the wall.

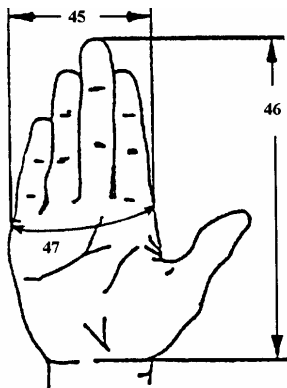


Sample	Percentiles					
	1st	5th	50th	95th	99th	
A Men	cm 77.9 (in) (30.7)	80.5 (31.7)	87.3 (34.4)	94.2 (37.1)	97.7 (38.5)	
B Women	cm 71.2 (in) (28.0)	73.5 (28.9)	79.6 (31.3)	86.2 (33.9)	89.0 (35.0)	

**Exhibit 14.3.2.1 (continued) Static human physical characteristics (hand)**

- 45 Hand Breadth.** The breadth of the hand, measured across the ends of the metacarpal bones (metacarpal-phalangeal joints). \*\*For Technical Operations Specialists, use # 14 in Appendix B.

			Percentiles				
Sample			1st	5th	50th	95th	99th
A	Men	cm	8.1	8.4	9.0	9.8	10.0
		(in)	(3.2)	(3.3)	(3.5)	(3.9)	(3.9)
B	Women	cm	7.1	7.3	7.9	8.6	8.9
		(in)	(2.8)	(2.9)	(3.1)	(3.4)	(3.5)



- 46 Hand Length.** The distance from the base of the hand at the wrist crease to the tip of the middle finger. \*\*For Technical Operations Specialists, use # 15 in Appendix B.

			Percentiles				
Sample			1st	5th	50th	95th	99th
A	Men	cm	17.3	17.9	19.3	21.1	21.9
		(in)	(6.8)	(7.0)	(7.6)	(8.3)	(8.6)
B	Women	cm	15.9	16.5	18.0	19.7	20.5
		(in)	(6.3)	(6.5)	(7.1)	(7.8)	(8.1)

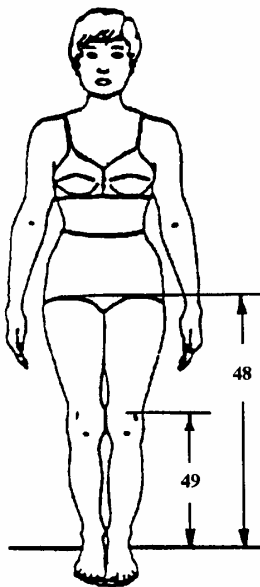
- 47 Hand Circumference.** The circumference of the hand, measured around the knuckles (metacarpal-phalangeal joints).

			Percentiles				
Sample			1st	5th	50th	95th	99th
A	Men	cm	19.2	19.9	21.3	23.0	23.7
		(in)	(7.6)	(7.8)	(8.4)	(9.1)	(9.3)
B	Women	cm	16.7	17.3	18.6	20.0	20.7
		(in)	(6.6)	(6.8)	(7.3)	(7.9)	(8.1)

**Exhibit 14.3.2.1 (continued) Static human physical characteristics (standing position)**

**48 Hip (Trochanteric) Height.** The vertical distance from the floor to the level of the maximum posterior protrusion of the greater trochanter of the femur (trochanterion).

			Percentiles				
Sample			1st	5th	50th	95th	99th
A	Men	cm	82.1	85.3	92.7	100.9	104.0
		(in)	(32.3)	(33.6)	(36.5)	(39.7)	(40.9)
B	Women	cm	76.1	78.9	86.0	93.8	97.5
		(in)	(30.0)	(31.1)	(33.9)	(36.9)	(38.4)



**49 Knee Height, Midpatella.** The vertical distance between a standing surface and the center of the right knee.

			Percentiles				
Sample			1st	5th	50th	95th	99th
A	Men	cm	44.3	46.1	50.4	55.2	56.8
		(in)	(17.4)	(18.1)	(19.8)	(21.7)	(22.4)
B	Women	cm	39.9	41.7	45.8	50.3	52.3
		(in)	(15.7)	(16.4)	(18.0)	(19.8)	(20.6)

### 14.3.3 Dynamic (mobile) body characteristics

This section presents: (1) information concerning the range of whole body motion characteristics, and (2) design rules and data on joint and body motion. Where such data are in other sections with application topics such as design for use and workplace design, cross references are provided.

#### 14.3.3.1 Range of whole body motion

Efficiency and accuracy of task performance can be maintained only if required body movements are within safe and comfortable limits. Human variability in range of body and joint movement is attributable to many factors, including the following:

- a. Age becomes a factor after age 60, at which time mobility has decreased 10 percent from youth.
- b. Sex differences favor greater range in females at all joints except the knee.
- c. Body build is a significant factor. Joint mobility decreases significantly as body build ranges from the very slender, through the muscular, to the obese.
- d. Exercise increases movement range. Weight training, jogging, and the like may tend to shorten certain muscle groups or increase their bulk so movement is restricted.
- e. Fatigue, disease, body position, clothing, and environment are other factors affecting mobility. [Source: NASA-STD-3000A, 1989; AFSC DH 1-3, 1980; Israelski, 1977]

This section provides introductory definitions related to the angular motion of skeletal joints. Knowledge of the range of joint motion helps the designer determine the placement and allowable movement of controls, tools, and equipment.

- **14.3.3.1.1 Trunk movement.** Workplace designs based upon design-driven body positions shall allow enough space to move the trunk of the body. The design shall be based upon:
  - a. the required tasks and human functions,
  - b. the need for optimal positions for applying forces, and
  - c. the need for comfortable body adjustments and movements. [Source: MIL-HDBK-759B, 1992]

- **14.3.3.1.2 Whole body movement.** If large forces that are greater than 13.6 kg (29.98 lb) or large control displacements that are more than 380 mm (14.96 in) in a fore-aft direction are required, the user shall be given enough space to move his or her entire body. [Source: MIL-HDBK-759B, 1992]

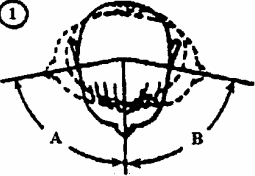
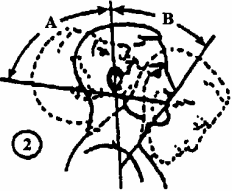
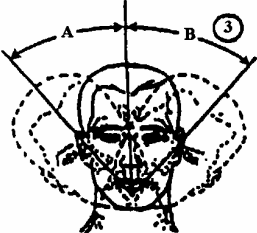
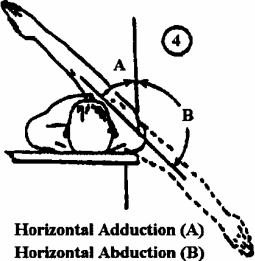
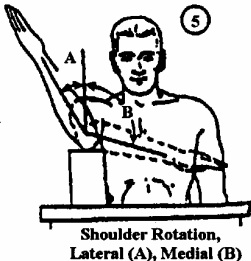
### 14.3.3.2 Joint motion

Joint motion capabilities make body movements possible. Joint movement is measured at the angle formed by the long axes of two adjoining body segments or at the angle formed by a body segment and a vertical or horizontal plane. The total range of motion is measured between the two extreme positions of the joint. The types of movement are defined below and are illustrated in Exhibits which follow.

**Definitions.** **Abduction** is movement away from the midline of the body. **Adduction** is movement toward the midline. **Circumduction** is a continuous circular movement of a limb. **Depression** is the lowering of a body member from its normal position. **Elevation** is the raising of a body member from a normal position. **Extension** is the straightening of a limb or an increase in the angle between parts of the body. **Flexion** is the process of bending a limb or decreasing the angle between parts of the body. **Lateral rotation** is turning away from the midline of the body, while **medial rotation** is turning toward the midline of the body. **Pronation** is the downward turning of the palm, or lying face down. **Supination** is the upward turning of the palm, or lying face up.

- **14.3.3.2.1 Single joint movements.** Designers and human factors specialists shall use the data in Exhibit 14.3.3.2.1 for design problems involving the movement of a single joint. This Exhibit presents single joint movement ranges for males and females. [Source: NASA-STD-3000A, 1989; MIL-HDBK-759B, 1992; Department of Defense (MIL-STD-1800A), 1990]

Exhibit 14.3.3.2.1 Joint movement ranges

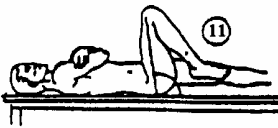
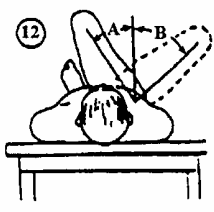

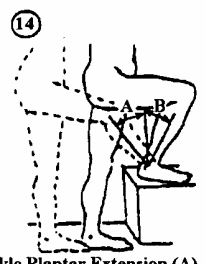
 <p>1 Neck Rotation, Right (A), Left (B)</p>	<b>Range of motion (degrees)</b>			
	<b>Males</b>		<b>Females</b>	
<b>Joint movement</b>	<b>5th percentile</b>	<b>95th percentile</b>	<b>5th percentile</b>	<b>95th percentile</b>
Neck, rotation right	73.3	99.6	74.9	108.8
Neck, rotation left	74.3	99.1	72.2	109.0
 <p>2 Neck Extension (A) Flexion (B)</p>	<b>Range of motion (degrees)</b>			
	<b>Males</b>		<b>Females</b>	
<b>Joint movement</b>	<b>5th percentile</b>	<b>95th percentile</b>	<b>5th percentile</b>	<b>95th percentile</b>
Neck, flexion	34.5	71.0	46.0	84.4
Neck, extension	65.4	103.0	64.9	103.0
 <p>3 Neck Lateral Bend Right (A), Left (B)</p>	<b>Range of motion (degrees)</b>			
	<b>Males</b>		<b>Females</b>	
<b>Joint movement</b>	<b>5th percentile</b>	<b>95th percentile</b>	<b>5th percentile</b>	<b>95th percentile</b>
Neck, lateral right	34.9	63.5	37.0	63.2
Neck, lateral left	35.5	63.5	29.1	77.2
 <p>4 Horizontal Adduction (A) Horizontal Abduction (B)</p>	<b>Range of motion (degrees)</b>			
	<b>Males</b>		<b>Females</b>	
<b>Joint movement</b>	<b>5th percentile</b>	<b>95th percentile</b>	<b>5th percentile</b>	<b>95th percentile</b>
Shoulder, abduction	173.2	188.7	172.6	192.9
 <p>5 Shoulder Rotation, Lateral (A), Medial (B)</p>	<b>Range of motion (degrees)</b>			
	<b>Males</b>		<b>Females</b>	
<b>Joint movement</b>	<b>5th percentile</b>	<b>95th percentile</b>	<b>5th percentile</b>	<b>95th percentile</b>
Shoulder, rotation lat	46.3	96.7	53.8	85.8
Shoulder, rotation med	90.5	126.6	95.8	130.9



**Exhibit 14.3.3.2.1 (continued) Joint movement ranges**

<p>6 Shoulder Flexion (A), Extension (B)</p>	<b>Range of motion (degrees)</b>				
	<b>Males</b>		<b>Females</b>		
	<b>5th percentile</b>	<b>95th percentile</b>	<b>5th percentile</b>	<b>95th percentile</b>	
<b>Joint movement</b>					
Shoulder, flexion	164.4	210.9	152.0	217.0	
Shoulder, extension	39.6	83.3	33.7	87.9	
<p>7 Elbow Flexion (B), Extension (A)</p>	<b>Range of motion (degrees)</b>				
	<b>Males</b>		<b>Females</b>		
	<b>5th percentile</b>	<b>95th percentile</b>	<b>5th percentile</b>	<b>95th percentile</b>	
<b>Joint movement</b>					
Elbow, flexion	140.5	159.0	144.9	165.9	
<p>8 Forearm Supination (A), Pronation (B)</p>	<b>Range of motion (degrees)</b>				
	<b>Males</b>		<b>Females</b>		
	<b>5th percentile</b>	<b>95th percentile</b>	<b>5th percentile</b>	<b>95th percentile</b>	
<b>Joint movement</b>					
Forearm, pronation	78.2	116.1	82.3	118.9	
Forearm, supination	83.4	125.8	90.4	139.5	
<p>9 Wrist Ulnar Bend(A), Radial Bend (B)</p>	<b>Range of motion (degrees)</b>				
	<b>Males</b>		<b>Females</b>		
	<b>5th percentile</b>	<b>95th percentile</b>	<b>5th percentile</b>	<b>95th percentile</b>	
<b>Joint movement</b>					
Wrist, radial	16.9	36.7	16.1	36.1	
Wrist, ulnar	18.6	47.9	21.5	43.0	
<p>10 Wrist Flexion (A), Extension (B)</p>	<b>Range of motion (degrees)</b>				
	<b>Males</b>		<b>Females</b>		
	<b>5th percentile</b>	<b>95th percentile</b>	<b>5th percentile</b>	<b>95th percentile</b>	
<b>Joint movement</b>					
Wrist, flexion	61.5	94.8	68.3	98.1	
Wrist, extension	40.1	78.0	42.3	74.7	

Exhibit 14.3.3.2.1 (continued) Joint movement ranges

 <p>11 Hip Flexion</p>	Range of motion (degrees)			
	Males		Females	
<u>Joint movement</u>	<u>5th percentile</u>	<u>95th percentile</u>	<u>5th percentile</u>	<u>95th percentile</u>
Hip, flexion	116.5	148.0	118.5	145.0
 <p>12 Hip Adduction (A), Abduction (B)</p>	Range of motion (degrees)			
	Males		Females	
<u>Joint movement</u>	<u>5th percentile</u>	<u>95th percentile</u>	<u>5th percentile</u>	<u>95th percentile</u>
Hip, abduction	26.8	53.5	27.2	55.9
 <p>13 Knee Flexion, Prone</p>	Range of motion (degrees)			
	Males		Females	
<u>Joint movement</u>	<u>5th percentile</u>	<u>95th percentile</u>	<u>5th percentile</u>	<u>95th percentile</u>
Knee, flexion	118.4	145.6	125.2	145.2
 <p>14 Ankle Plantar Extension (A), Dorsi Flexion (B)</p>	Range of motion (degrees)			
	Males		Females	
<u>Joint movement</u>	<u>5th percentile</u>	<u>95th percentile</u>	<u>5th percentile</u>	<u>95th percentile</u>
Ankle, planar	36.1	79.6	44.2	91.1
Ankle, dorsi	8.1	19.9	6.9	17.4

- **14.3.3.2.2 Range of motion for two joints.** Exhibit 14.3.3.2.2 shall be used for design problems involving the motion of two joints. Designers shall avoid using single joint movement data for adjacent joints because they are usually not additive. [Source: NASA-STD-3000A, 1989; MIL-HDBK-759B, 1992; MIL-STD-1800A, 1990]

**Discussion.** The range of joint movement is drastically reduced by movement of the adjacent joint. Exhibit 14.3.3.2.2 defines the change in range of motion of a given joint when complemented by movement of the adjacent joint.

**Example.** The following illustrates how Exhibit 14.3.3.2.2 is to be used. The first entry is read: the average shoulder has a full range of extension of 59.3 degrees with the elbow in a neutral position (locked in hyperextension). When shoulder extension was measured with the elbow flexed to one third of its full joint movement range (these movements can be determined from illustrations six and seven in the previous Exhibit), the mean value of shoulder extension was found to increase by 1.6 degrees, or approximately 103 percent of the base value. The results for other movements and adjacent joint positions are presented in a similar manner.

**Exhibit 14.3.3.2.2** Change in range of joint movement with movement in an adjacent joint

Two-joint movement	Full range of 1st (degrees)	Change in range of movement of 1st joint (degrees)				
		Movement of 2nd joint (fraction of full range)				
		Zero	1/3	1/2	2/3	Full
Shoulder extension (1) with elbow flexion (2)	59.3		+1.6 deg (102.7%)		+0.9 deg (101.5%)	+5.3 deg (108.9%)
Shoulder flexion (1) with elbow flexion (2)	190.7		-24.9 deg (86.9%)		-36.1 deg (81.0%)	-47.4 deg (75.0%)
Elbow flexion (1) with shoulder extension (2)	152.2			-3.78 deg (97.5%)		-1.22 deg (99.2%)
Elbow flexion (1) with shoulder flexion (2)	152.2		-0.6 deg (99.6%)		-0.8 deg (99.5%)	-69.0 deg (54.7%)
Ankle plantar flexion (1) with knee flexion (2)	48.0		-3.4 deg (92.9%)		+0.2 deg (100.4%)	+1.6 deg (103.3%)
Knee flexion (1) with ankle planar flexion (2)	127.0			-9.9 deg (92.2%)		-4.7 deg (96.3%)
Knee flexion (1) with ankle dorsiflexion (2)	127.0					-8.7 deg (93.9%)
Knee flexion (1) with hip flexion (2)	127.0			-19.6 deg (84.6%)		-33.6 deg (73.5%)

## 14.4 Reach

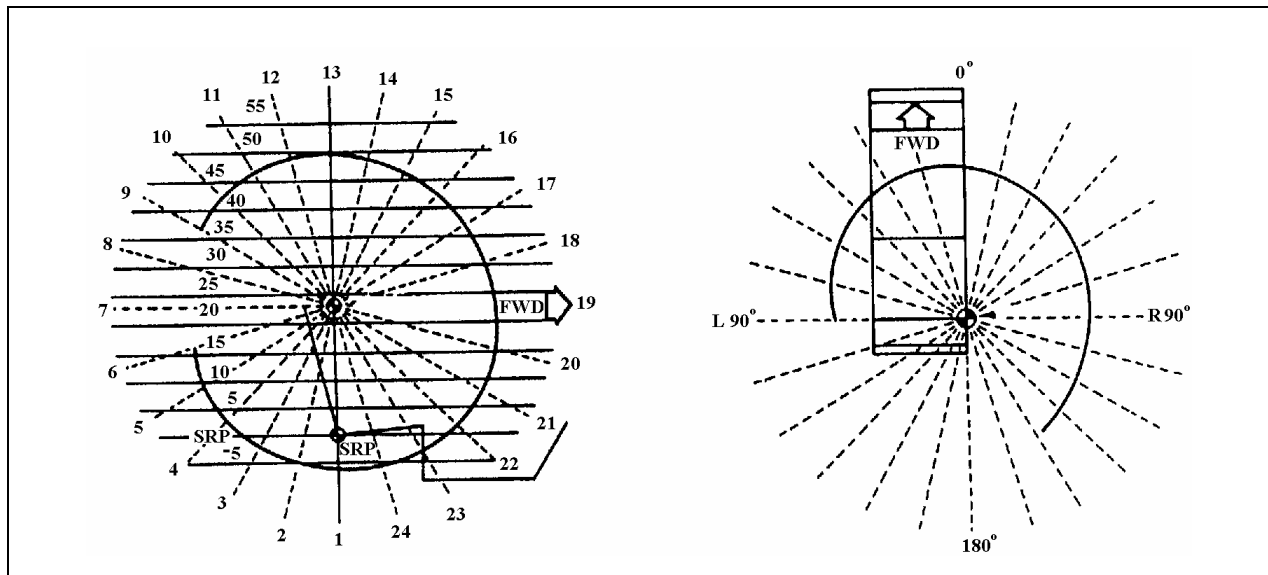
Reach limits are clearly dependent on the task, motion, and function to be accomplished by the reach action. Limited reach data on standard anthropometric positions are available in sources of static and dynamic anthropometric data. Reach envelopes need to be constructed for actual working positions and for explicit design purposes. Reach envelopes may be related to a body reference point (such as the shoulder joint), to a measurement apparatus point, or to a design point (such as a seat reference point). This section provides design criteria and rules for using reach data and constructing reach envelopes. [Source: NASA-STD-3000A, 1989]

- **14.4.1 Task and body position effects.** The following task considerations shall be taken into account in order to establish reference points and to obtain the reach information needed to construct a reach envelope:
  - a. the nature and requirements of the task to be performed (see also Paragraphs 14.3.1.2 and 14.4.3 for the nature of the reach task),
  - b. body position while reaching (standing, seated, seat back and seat pan angles, and others),
  - c. whole body movement capabilities and restraints (seat belts, harnesses, necessary and permitted movements of the torso),
  - d. design purposes such as: to accommodate the appropriate portion of the population, to enhance task performance, or to avoid striking reachable surfaces, and
  - e. equipment locations that interfere with reach, vision or intercommunications. [Source: NASA-STD-3000A, 1989]

- **14.4.2 Reach envelope data collection.** Designers and human factors specialists should understand that reach envelope measurement data are often related to the data collection procedures and apparatus. Often data can be found or should be collected to relate the design reference point of concern to the reach capabilities of the actual users. Another factor in data collection is the amount of whole body movement allowed. For example, consider bending the torso forward so that one or both shoulders no longer touch the seat back. [Source: Roebuck, Kroemer, & Thomson, 1975]

**Example.** Exhibit 14.4.2 shows an example in which reach measurement is related to the seat reference point from a restrained shoulder level. In the left graph, a side view reference plane is shown, and in the right graph, a top view is shown in terms of reach angles. All measures and dimensions are relative to the apparatus.

**Exhibit 14.4.2** Reach envelopes in vertical and horizontal planes

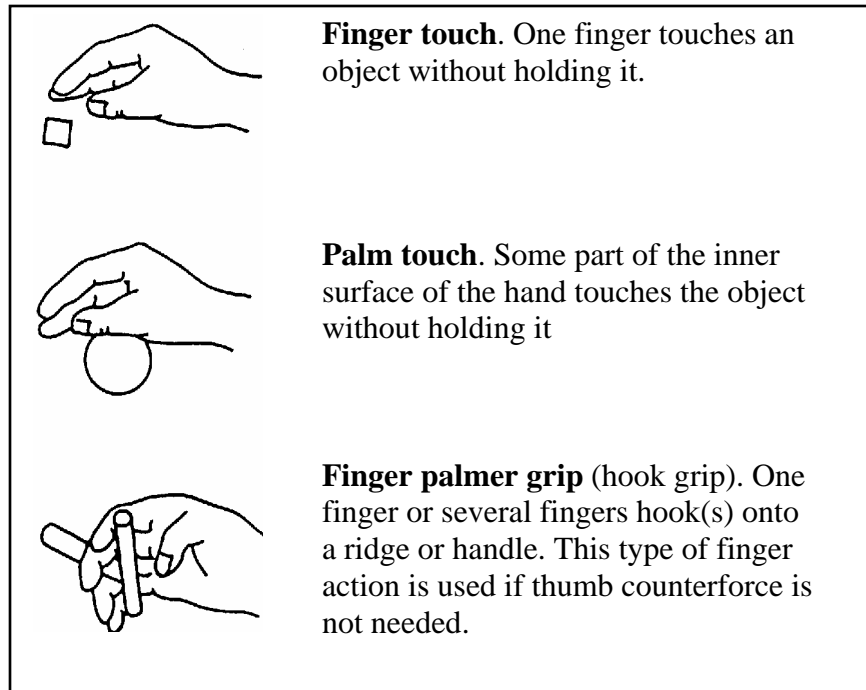


**Discussion.** An issue surrounding the application of reach data is how to relate static anthropometric reach dimensions, shoulder joint points, data collection procedures and apparatus reference points, and design reference points. Most reach measurements are made relative to an apparatus reference point. A further complication is that the apparatus and design seat reference point may not be the same or may not reflect the same seat configurations (back and pan angles).

**Definition.** **Seat reference point** is a point in the mid-sagittal plane where the seat back and seat pan intersect.

- **14.4.3 Reach envelope interaction with the reach task.** Reach envelope data shall be collected or modified for the tasks, motions, or functions to be accomplished by the reach. Exhibit 14.4.3 (a) defines some task demands (touch, grip, and grasp) that affect reach characteristics and measures. [Source: Kroemer, Kroemer, & Kroemer-Elbert, 1990]

**Exhibit 14.4.3 (a)** Touch, grip, and grasp functions



**Exhibit 14.4.3 (a) (continued) Touch, grip, and grasp functions**

**Thumb-fingertip grip (“tip grip”).** The thumb tip opposes one fingertip.



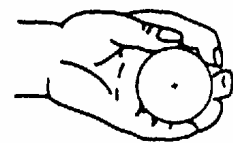
**Thumb-finger palmar grip (“pinch grip”).** Thumb pad opposes the palmar pad of one finger, or the pads of several fingers near the tips. This grip evolves easily from coupling the thumb-fingertip grip.



**Thumb-forefinger side grip (lateral grip or “side pinch”).** Thumb opposes the (radial) side of the forefinger.



**Thumb-two-finger grip (“writing grip”).** Thumb and two fingers (often forefinger and index finger) oppose each other at or near the tips.



**Thumb-fingertips enclosure (“disk grip”).** Thumb pad and the pads of three or four fingers oppose each other near the tips (object grasped does not touch the palm). This grip evolves easily from the thumb-two-finger grip.



**Finger-palm enclosure (“enclosure”).** Most, or all, of the inner surface of the hand is in contact with the object while enclosing it.



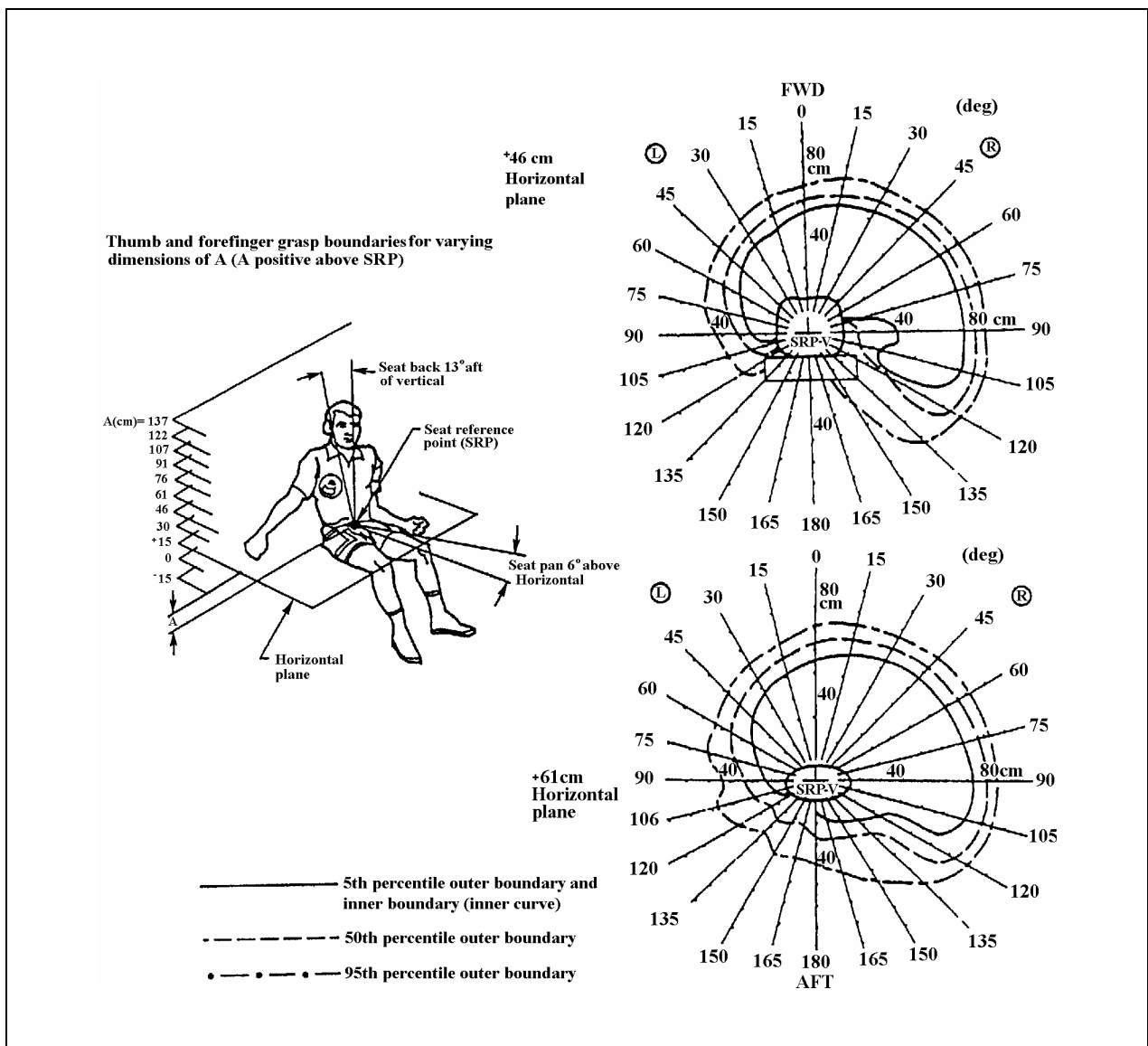
**Grasp (“power grasp”).** The total inner hand surface is grasping the (often cylindrical) handle which runs parallel to the knuckles and generally protrudes on one side or both sides from the hand.



**Discussion.** Fingertip touch results in the largest reach dimensions appropriate for touch controls. Other grasp functions would reduce the reach envelope. Two-handed operations, greater precision, and frequent or continuous operation would necessitate locating the task closer to the body. Bulky clothing could affect reach capabilities.

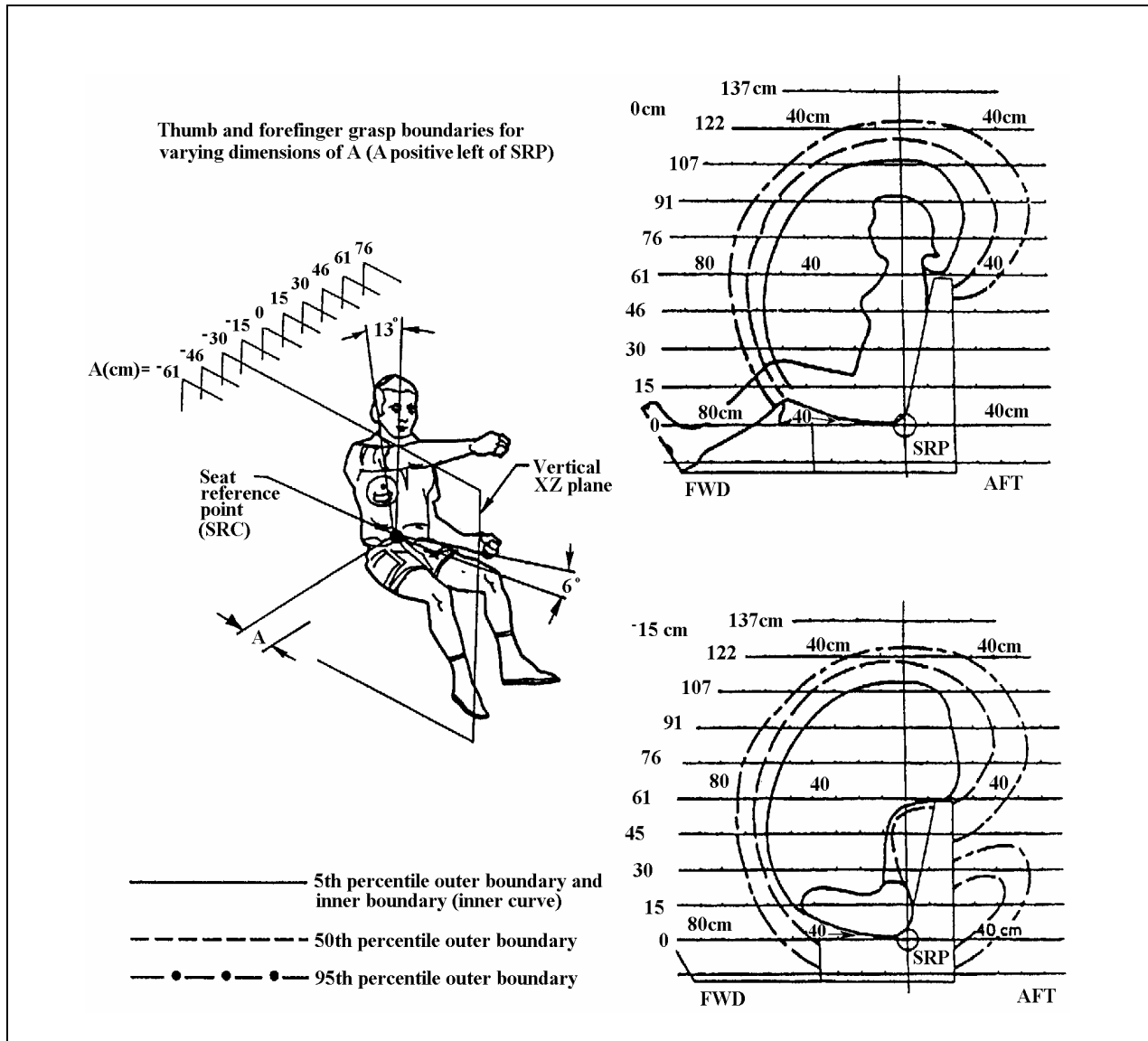
**Examples.** Exhibits 14.4.3 (b) and (c) present 5th percentile female reach envelope data as examples of one possible presentation for such data. The data represent right hand reach for a fingertip grasp task. In Exhibit 14.4.3 (b) horizontal contours are shown at the 46 and 61 cm levels.

**Exhibit 14.4.3 (b)** Thumb and forefinger grasp boundary data for females in the 46 cm and 61 cm horizontal planes



In Exhibit 14.4.3 (c) vertical planes are shown for the 0 and -15 cm planes. For design use, data would be presented for other horizontal and vertical planes. For this example, shoulders were restrained against the seat.

**Exhibit 14.4.3 (c)** Thumb and forefinger grasp boundary data for females in the 0 and -15 cm vertical planes



Three factors can affect three-dimensional reach envelopes: the effects of different hand manipulation tasks, the effects of permitting torso and shoulder movement, and the effects of the seat back angle of the data collection apparatus. For instance, the Exhibit shows thumb and forefinger grasp. Not shown is that fingertip touch reach would increase by 7.0 cm (2.8 in) and full hand grasp reach would decrease by -5.5 cm (2.2 in) from their fingertip grasp reach values.

Additional data also not shown in the Exhibit reveals that if the seat back angle were changed from 13 degrees rearward (as shown in the Exhibits) to the vertical position, that is to 90 degrees, then reach measures in a horizontal plane from 0 degrees (arm straight forward and horizontal) to 90 degrees to the right increase as follows:

- a. at 0 degrees, by 1.02 cm (.40 in);
  - b. at 15 degrees, by 1.27 cm (.50 in);
  - c. at 45 degrees, by .94 cm (.37 in);
  - d. at 60 degrees, by .66 cm (.26 in); and
  - e. at 90 degrees, by .25 cm (.10 in).
- **14.4.4 Strength or fine manipulation.** Tasks which require strength or fine manipulation, as well as repetitious tasks should be located well within the perimeter of the reach limit envelope. [Source: NASA-STD-3000A, 1989]

**Discussion.** The strength that can be exerted varies considerably throughout the reach envelope. As was noted in the previous example, the reach envelope varies with the type of grasp required in defining the envelope. This rule points out that one may need to further accommodate the task location by the strength, fine manipulation, or repetitive nature of the tasks to be performed. In these cases, consider the capabilities of the small (1st or 5th percentile) female user and also provide sufficient space and adjustability to accommodate the large male.

## 14.5 Human strength and handling capacity

The designer and human factors specialist needs to know the limits and ranges of human strength to create designs that are within the capabilities of potential users. If demands on human strength are too high, inefficient and unsafe worker performance will result. If the designer underestimates strength, unnecessary design effort and expense may be incurred.

This section introduces muscle strength factors and provides criteria and rules on control forces, as well as push and pull forces. This section also provides supplemental criteria and rules on lifting and carrying.

### 14.5.1 Muscle strength factors

The forces delivered by the human body depend on the contractile strength of the muscles, and the mechanical advantages of the body lever system with the joints serving as fulcra and the long bones serving as levers.

Knowledge of some of the many factors that relate to muscular strength may aid design personnel in understanding human physical capabilities. In addition to the strength capabilities of various body members, other factors include: (1) age, (2) endurance, (3) gender, (4) body build, (5) body position, (6) handedness, (7) exercise, (8) diet and drugs, (9) diurnal variation, and (10) emotional and fatigue states. Gender and handedness are discussed below while strength limit factors are presented in the criteria and rules throughout Section 14.5.  
[Source: Israelski: 1977]

**Discussion.** In general, females are about 35 to 85% as strong as males with varying differentials for various muscle groups. Gender differences favor greater range in joint motion in females at all joints except the knee. The preferred hand and arm are approximately 10% stronger than the non-preferred hand and arm.

**Definitions.** There are three basic categories of strength: (1) **static strength**, also known as isometric strength, which is steady force exerted while the limbs are in a stationary or static position, (2) **dynamic strength**, which is a force exerted by limbs moving in a smooth manner over time, such as while lifting an object, and (3) **explosive strength**, which is the application of peak amounts of strength for short periods of time, usually periodically, such as in running or sprinting.

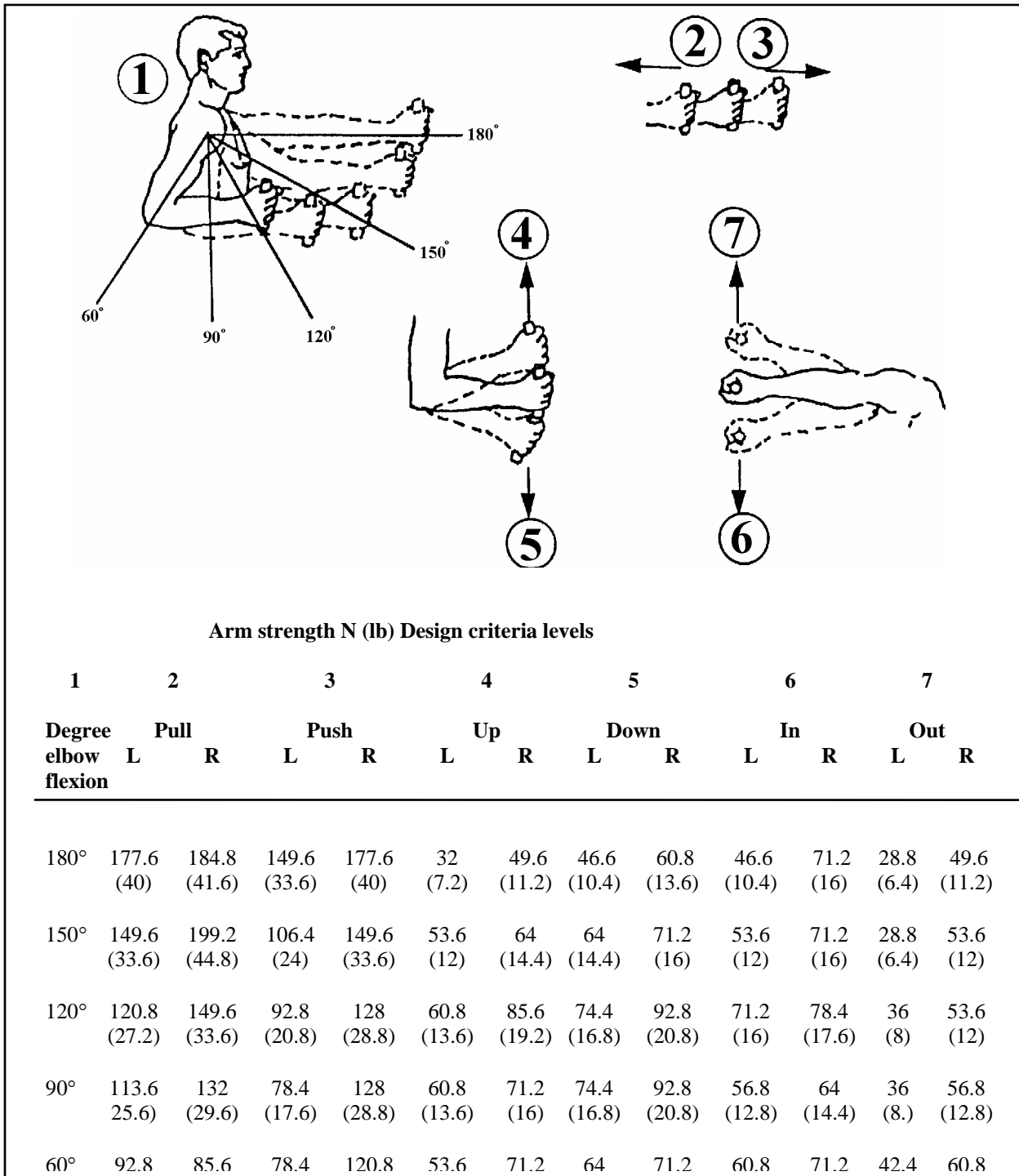
## 14.5.2 Exerted forces

- **14.5.2.1 Maximum young male force or resistance for a control.** The maximum amount of force or resistance designed into a control should be determined by the greatest amount of force that can be exerted by the weakest person likely to operate the control. Control force limits, like most strength design limits, should be based upon the 5th percentile (or, for critical tasks, the 1st percentile) of the female user population. [Source: MIL-HDBK-759B, 1992; AFSC DH 1-3, 1980]

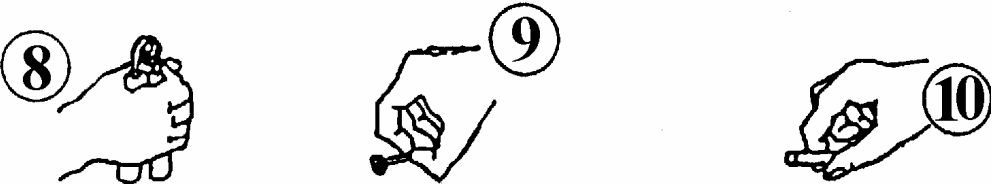
Exhibit 14.5.2.1 represents 80% of the maximum exertion forces for the 5th percentile male for the arm, hand and thumb. Since the experimental conditions used to collect the source data yielded maximum possible exertion values for young men, these values were too high for design purpose. For design, one does not want to deliberately or consistently require maximum exertions. Thus these source values were reduced by 20% before applying them as design criteria. Male data should be selected based upon the body components involved in the specific exertion task. To estimate female strength, male data should be further reduced according to Paragraph 14.5.2.3. Females can apply most strength when torso, back, and legs are major contributors. Female upper body and arm strength are weakest (see also comparative lifting strength information Paragraph 14.5.2.3).

**Discussion.** The maximum force that can be applied will depend on such factors as the type of control, the body member used to operate it, the position of this body member during control operations, the general position of the body, and whether or not support is provided by backrests.

**Exhibit 14.5.2.1** Male muscle strength of the arm, hand, and thumb for control forces (5th percentile values)



**Exhibit 14.5.2.1 (continued)** Design criteria for male muscle strength of the arm, hand, and thumb for control forces (5th percentile values)



Hand and thumb-finger strength N (lb)				
	8		9	10
	Hand grip L	Hand grip R	Thumb-finger grip (palmer)	Thumb-finger grip (tips)
Momentary hold	200 (44.8)	208 (47.2)	48 (10.4)	48 (10.4)

- **14.5.2.2 Increasing strength values.** Strength values shall be slightly increased if:

  - a. a lifting yoke or other special harness is to be used,
  - b. the object is unusually easy to handle,
  - c. the required force must be applied infrequently or only for a few seconds, if more than one per 30 seconds, decrease by .30 or
  - d. the working body parts are provided with suitable support. [Source: MIL-HDBK-759B, 1992; MIL-STD-1472D, 1989; MIL-STD-1800A, 1990; AFSC DH 1-3, 1980]

- **14.5.2.3 Comparative strength.** Research has produced little insight into the strength of women relative to men. The following strength relationships developed by the US Army Research Institute of Environmental Medicine should be used until better data becomes available:
  - a. For upper extremities, females strength is 56.5% of men.
  - b. For lower extremities, female strength is 64.2% of men.
  - c. For trunk extremities, female strength is 66.0% of men.

**Explanation.** These numbers may serve as a design rule until more information becomes available.

- **14.5.2.4 Preventing tremor in positive control performance.** Tremor is important in activities in which a body member is maintained in a precise position or motion (tasks involving fine continuous control, detailed drawing, tracking, tracing, cutting, or painting). The following features should be designed into systems or equipment, where applicable, to help reduce tremor and ensure positive control performance of fine detailed tasks:
  - a. ensure that visual reference can be used,
  - b. provide support of the body and the member involved, for example, the hand or arm,
  - c. support the hand because tremor is less if the hand is 203.2 mm (8 in) above or below the heart level, and
  - d. provide mechanical friction in the control device to add enough resistance to movement to partially counteract the energy of the vibrations of the body member. [Source: Israelski, 1977]

**Definition and discussion.** Tremor is the oscillation of a body extremity which may occur along with an effort to maintain a fixed position or direction. The degree of tremor is measured by the distance or number of departures from the fixed path or position per unit of time. Tremor increases when (1) effort is made not to tremble, and (2) fatigue is present. It is greatest in vertical motion, less in front-to-back motion, and least in side-to-side motion.



### 14.5.3 Push and pull forces

- **14.5.3.1 Horizontal direction of force.** Manual horizontal push and pull forces that are initially necessary to set an object in motion, or to sustain the motion over a period of time, should not exceed the values given in Exhibit 14.5.3.1. For the second or third person applying horizontal forces, the value in the Exhibit's first column should be doubled or tripled, respectively. For each additional person (beyond the third) another 75 percent of the force value in the first column should be added. [Source: MIL-HDBK-759B, 1992]

**Explanation.** The Exhibit shows maximum push and pull forces that a designer would be expected to use when appropriate body positions, support, and traction conditions are provided. Use of the maximum values shown in the Exhibit is predicated upon a suitable surface for force exertion (vertical with rough surface approximately 400 mm (15.75 in) wide and between 0.51 - 1.27 m (1.673 - 4.167 ft) above the floor) to allow force application with the hands, shoulders, or back.

**Exhibit 14.5.3.1** Horizontal push and pull forces that can be exerted

Exertable horizontal force	Applied with	Condition ( $\mu$ : coefficient of friction)
110 N (24.7 lbf) push or pull	both hands or one shoulder or the back	with low traction $0.2 < \mu < 0.3$
200 N (45.0 lbf) push or pull	both hands or one shoulder or the back	with medium traction $\mu = 0.6$
240 N (54.0 lbf) push	one hand	if braced against a vertical wall 510-1520 mm (20.08-59.84 in) from and parallel to the push panel
310 N (70.0 lbf) push or pull	both hands or one shoulder or the back	with high traction $\mu > 0.9$
490 N (110.2 lbf) push or pull	both hands or one shoulder or the back	if braced against a vertical wall 510-1780 mm (20.08-70.08 in) from and parallel to the panel or if anchoring the feet on a perfectly non-slip ground (like a footrest)
730 N (164.1 lbf) push	the back	if braced against a vertical wall 580-1090 mm (22.83-42.91 in) from and parallel to the push panel or if the anchoring the feet on a perfectly non-slip ground (like a footrest)

- **14.5.3.2 Vertical direction of force.** Required manual vertical static lift forces should not exceed the applicable 5th percentile peak or mean force values given in Exhibit 14.5.3.2. [Source: MIL-HDBK-759B, 1992]

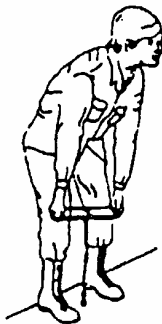
**Explanation.** Based upon NIOSH experience, the forces found in the source that studied young military personnel have been reduced by 20 percent (Exhibit 14.5.3.2). The mean forces given represent force over a three second interval, beginning two seconds after it reached a minimum value of 45 N provided that it continued to exceed this minimum. Exhibit 14.5.3.2 reflects the higher of two trials for each condition.

**Exhibit 14.5.3.2** Static muscle strength data for vertical pull exertions



**A. Standing two-handed pull: 38 cm (15.0) level.** Standing with feet 45 cm (17.7 in) apart and knees bent; bending at the waist, grasping both sides of a 45 cm (17.7 in) handle located directly in front, 38 cm (15.0 in) above standing surface, and pulling, using primarily arms, shoulders, and legs

Strength measurements	5th percentile		95th percentile	
	Male	Female	Male	Female
Mean force (N)	737.5	330.9	1354.5	817.6
Mean force (lbf)	(165.80)	(74.39)	(304.50)	(183.80)
Peak force (N)	844.7	396.9	1437.2	888.3
Peak force (lbf)	(189.90)	(89.23)	(323.10)	(199.70)



**B. Standing two-handed pull: 50 cm (19.7 in) level.** Standing with feet 45 cm (17.7 in) apart and knees straight; bending at the waist, grasping both sides of a 45 cm (17.7 in) handle located directly in front, 50 cm (19.7 in) above standing surface, and pulling, using primarily arms and shoulders

Strength measurements	5th percentile		95th percentile	
	Male	Female	Male	Female
Mean force (N)	758.0	326.1	1341.6	840.7
Mean force (lbf)	(170.41)	(73.31)	(301.60)	(189.00)
Peak force (N)	830.9	374.1	1441.7	905.2
Peak force (lbf)	(186.79)	(84.10)	(324.11)	(203.50)



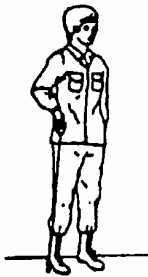
**C. Standing two-handed pull: 100 cm (39.4 in) level.** Standing erect with feet 45 cm (17.7 in) apart, grasping both sides of a 45 cm (17.7 in) handle located directly in front, 100 cm (39.4 in) above the standing surface, and pulling, using the arms

Strength measurements	5th percentile		95th percentile	
	Male	Female	Male	Female
Mean force (N)	444.4	185.0	931.0	443.0
Mean force (lbf)	(99.91)	(41.59)	(209.30)	(99.59)
Peak force (N)	504.0	218.0	988.4	493.3
Peak force (lbf)	(113.30)	(49.01)	(222.20)	(110.90)

**Exhibit 14.5.3.2 (continued) Static muscle strength data for vertical pull exertions**

- D. Standing two-handed push: 150 cm (59.1 in) level.** Standing erect with feet 45 cm (17.7 in) apart grasping from below, both sides of a 45 cm (17.7 in) handle located directly in front, 150 cm (59.1 in) above standing surface, pushing upward using arms and shoulders

Strength measurements	5th Percentile		95th Percentile	
	Male	Female	Male	Female
Mean force (N)	408.8	153.5	1016.9	379.9
Mean force (lbf)	(91.9)	(34.51)	(228.61)	(85.41)
Peak force (N)	472.8	187.7	1094.3	430.1
Peak force (lbf)	(106.29)	(42.20)	(246.02)	(96.69)



- E. Standing one-handed pull: 100 cm (39.4 in) level.** Standing erect with feet 15 cm (5.9 in) apart dominant hand grasping underside of D-ring located directly to the side, 100 cm (39.4 in) above standing surface, pulling upward while keeping shoulder square and other arm relaxed at side

Strength measurements	5th Percentile		95th Percentile	
	Male	Female	Male	Female
Mean force (N)	214.8	102.8	627.6	283.8
Mean force (lbf)	(48.29)	(23.11)	(141.09)	(63.8)
Peak force (N)	258.9	131.7	724.2	322.5
Peak force (lbf)	(58.20)	(29.61)	(162.81)	(72.50)



- F. Seated one-handed pull: seat centerline 45 cm (39.4 in) level.** Sitting erect with feet 55 cm (21.7 in) apart, dominant hand grasping underside of D-ring located directly to the front, 45 cm (17.7 in) above the floor, pulling upward while keeping shoulder square and other arm resting in lap

Strength measurements	5th Percentile		95th Percentile	
	Male	Female	Male	Female
Mean force (N)	222.3	106.3	678.4	391.9
Mean force (lbf)	(49.98)	(23.90)	(152.51)	(88.11)
Peak force (N)	273.1	127.2	758.4	450.6
Peak force (lbf)	(61.40)	(28.60)	(170.50)	(101.30)

**Exhibit 14.5.3.2 (continued) Static muscle strength data for vertical pull exertions**



**G. Seated one-handed pull: side of seat, 45 cm (17.7 in) level.**  
 Sitting erect with feet 55 cm (21.7 in) apart, dominant hand grasping underside of D-ring located a short distance to side, 45 cm (17.7 in) above the floor, pulling upward while keeping shoulders square and other arm resting in lap

Strength measurements	5th percentile		95th percentile	
	Male	Female	Male	Female
Mean force (N)	408.8	153.5	1016.9	379.9
Mean force (lbf)	(91.90)	(34.51)	(228.61)	(85.41)
Peak force (N)	472.8	187.7	1094.3	430.1
Peak force (lbf)	(106.29)	(42.20)	(246.02)	(96.69)



**H. Seated two-handed pull: centerline of seat, 38 cm (14.96 in) level.**  
 Sitting erect with feet 55 cm (21.7 in) apart, bending slightly at waist, grasping both sides of 15 cm (5.9 in) handle located directly to the front, 38 cm (15.0 in) above the floor, pulling upward using arms and shoulders, keeping arms off thighs

Strength measurements	5th percentile		95th percentile	
	Male	Female	Male	Female
Mean force (N)	214.8	102.8	627.6	283.8
Mean force (lbf)	(48.29)	(23.11)	(141.09)	(63.80)
Peak force (N)	258.9	131.7	724.2	322.5
Peak force (lbf)	(58.20)	(29.61)	(162.81)	(72.50)



**I. Seated two-handed pull: centerline of seat, 50 cm (19.7 in) level.**  
 Sitting erect with feet 55 cm (21.7 in) apart, bending slightly at the waist, grasping both sides of 15 cm (5.9 in) handle located directly to the front, 50 cm (19.7 in) above the floor, pulling upward using arms and shoulders, keeping arms off thighs

Strength measurements	5th percentile		95th percentile	
	Male	Female	Male	Female
Mean force (N)	222.3	106.3	678.4	391.9
Mean force (lbf)	(49.98)	(23.90)	(152.51)	(88.11)
Peak force (N)	273.1	127.2	758.4	450.6
Peak force (lbf)	(61.40)	(28.60)	(170.50)	(101.30)

### 14.5.4 Lifting and carrying

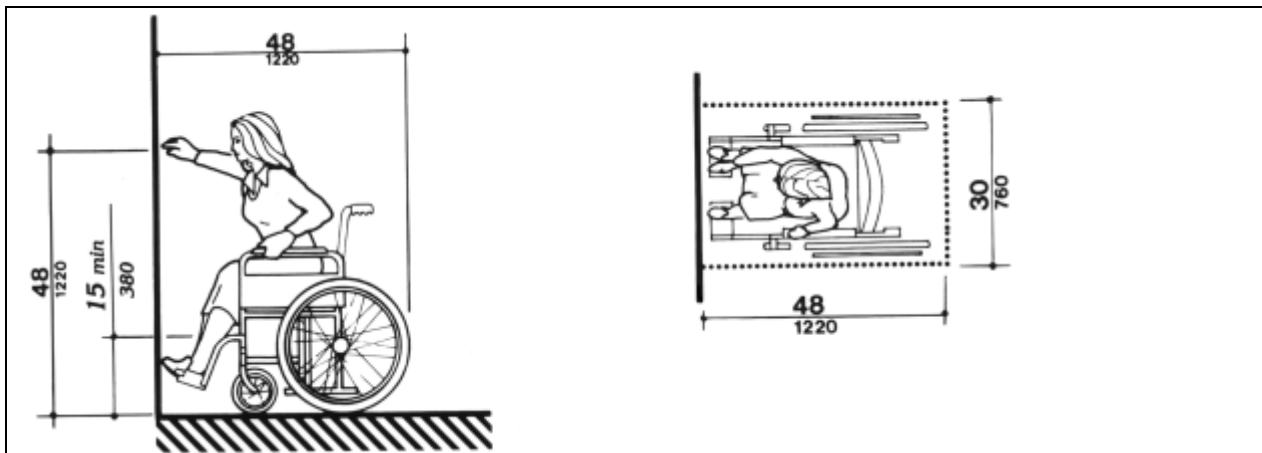
There are three major muscular components of weight-lifting: (1) the legs, (2) the arms-back, and (3) the arms. In efficiently lifting objects to different heights, these components are combined in different ways. Specifically, lifting objects to about knee height involves primarily the use of the leg component, while objects lifting to about waist level involves a combination of leg and arm-back components. Lifting objects to shoulder level or higher requires the use of all three components.

- **14.5.4.1 Lifting and carrying limits.** Data, criteria, and rules in Chapter 4 shall be used to establish recommended maximum weights to be lifted and carried by one and two people. [Source: AFSC DH 1-3, 1980; Israelski, 1977; NASA-STD-3000A, 1989]

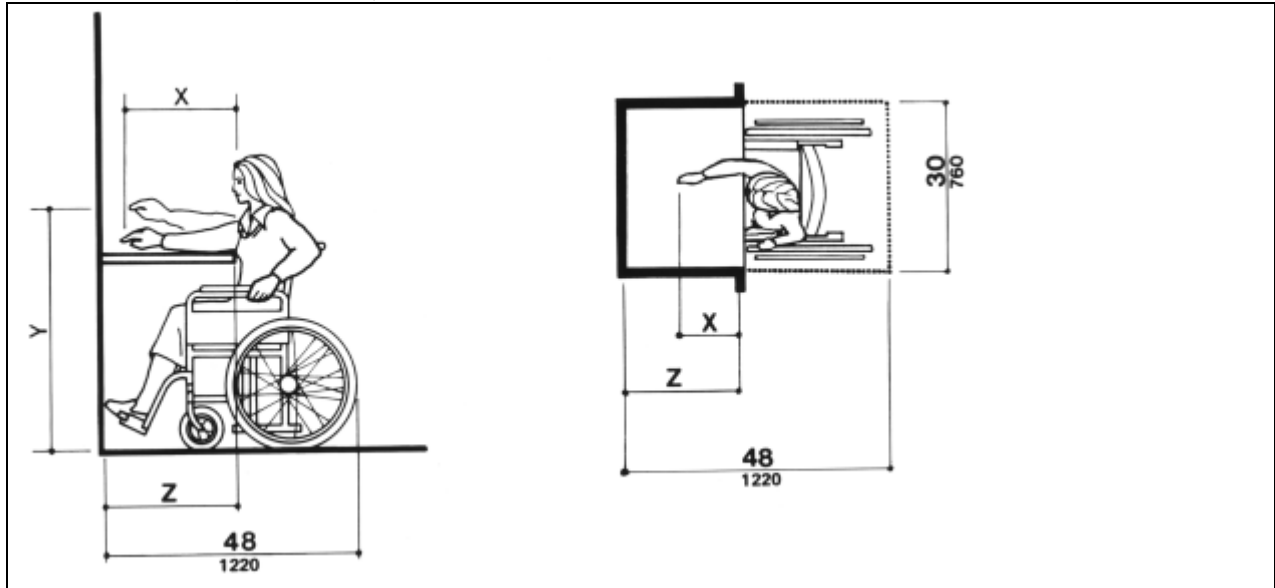
### 14.6 Wheelchair anthropometrics

- **14.6.1 Maximum high forward reach in a wheelchair.** If the clear floor space only allows forward approach to an object, the maximum high forward reach allowed shall be 48 in (1220 mm)(see Exhibit 14.6.1), unless there is an obstruction projecting 20 to 25 in (510 to 635 mm), in which case it is 44 inches (1120mm). [Source: UFAS, 1988]
- **14.6.2 Minimum low forward reach in a wheelchair.** If the clear floor space only allows forward approach to an object, the minimum low forward reach shall be 15 in (380 mm)(See Exhibit 14.6.1). [Source: UFAS, 1988]
- **14.6.3 Maximum reach over obstruction in a wheelchair.** The maximum forward reach over an obstruction with knee space below shall be 635 mm (25in) (see Exhibit 14.6.1). [Source: UFAS, 1988]

**Exhibit 14.6.1** Forward reach from a wheelchair.

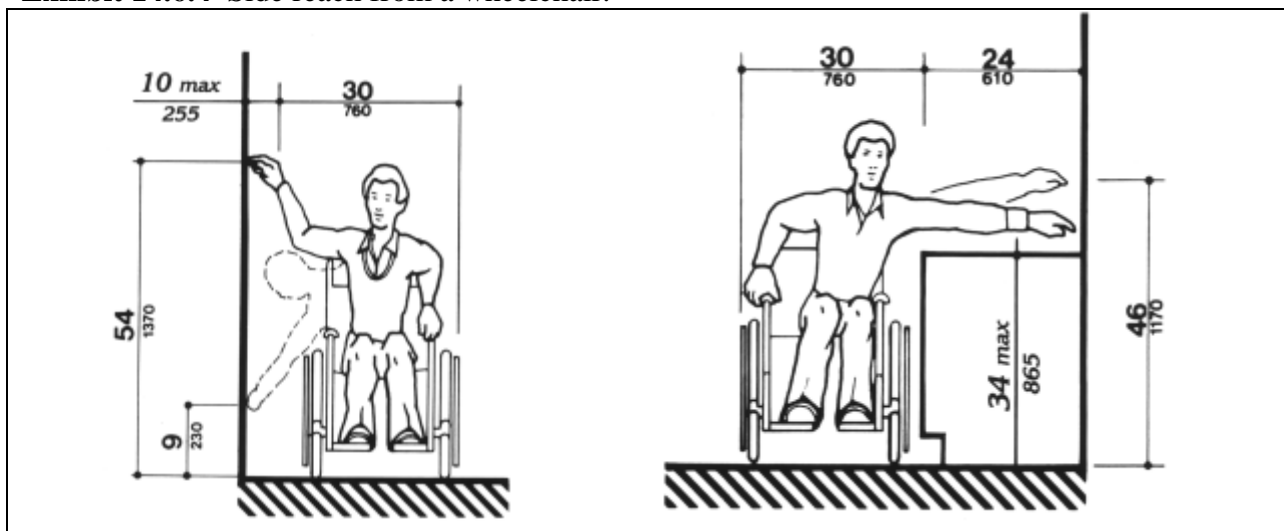


**Exhibit 14.6.1 (continued)** Forward reach from a wheelchair



- **14.6.4 Maximum side reach in a wheelchair.** If the clear floor space allows only parallel approach to an object by a person in a wheelchair, the maximum high side reach allowed shall be 54 in (1370 mm)(see Exhibit 14.6.4), unless there is an obstruction projecting 20 to 25 in (510 to 635 mm), in which case it is 46 inches (1170mm). [Source: UFAS, 1988]
- **14.6.5 Minimum side reach in a wheelchair.** If the clear floor space allows only parallel approach to an object by a person in a wheelchair, the minimum side reach allowed shall be no less than 9 in (230 mm)(see Exhibit 14.6.4) above the floor. [Source: UFAS, 1988]

**Exhibit 14.6.4** Side reach from a wheelchair.

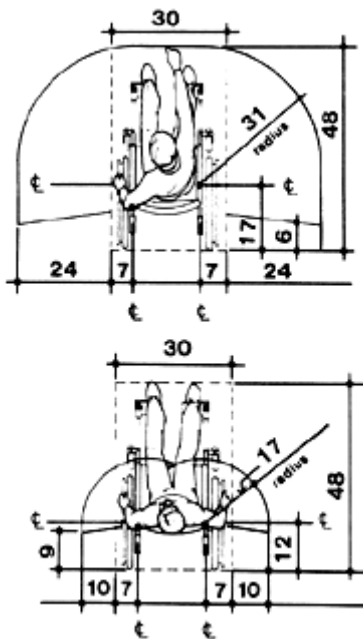


- 14.6.6 Wheelchair dimensions.** Designers and human factors specialists shall use the data in Exhibit 14.6.6 for design problems involving wheelchair users. This Exhibit presents wheelchair dimension data. [Source: UFAS, 1988]

**Exhibit 14.6.6** Wheelchair dimensions.

The height of the handle is at 36 inches (915 mm). The armrest is 30 inches (760 mm) high. Eye level is between 43 and 51 inches (1090-1295 mm). The lap is at 27 inches (685 mm). The seat is at 19 inches (485 mm). The toe is at 8 inches (205 mm). The width of a wheelchair measured from the outer edges of the back wheels is 26 inches (660 mm); the length is 42 inches (1065 mm); the width measured from the outer edges of the footrests is 18 inches (455 mm). The toes extend 6 inches (150 mm) beyond the edge of the footrests.

Note: Footrests may extend further for very large people.





## Glossary

**Abduction** - Movement away from the midline of the body.

**Acromion** - The point of the shoulder.

**Adduction** - Movement toward the midline.

**Anthropometry** - The scientific measurement and collection of data about human physical characteristics and the application (engineering anthropometry) of these data in the design and evaluation of systems, equipment, manufactured products, human-made environments, and facilities.

**Bideltoid breadth** - The maximum horizontal distance between the lateral margins of the upper arms on the deltoid muscles.

**Biomechanics** - Describes the mechanical characteristics of biological systems, in this case the human body, in terms of physical measures and mechanical models.

**Circumduction** - A continuous circular movement of a limb.

**Correlation coefficient or "r" value** - Describes the degree to which two variables vary together (positive correlation) or vary inversely (negative correlation). The correlation coefficient ( $r$ ), has a range of values from +1.0 (perfect positive correlation) through -1.0 (perfect negative correlation). Multiple correlation involves the predictable relationship of two or more variables with another criterion variable (such as a composite measurement value).

**Crinion** - The midpoint of the hairline.

**Depression** - The lowering of a body member from its normal position.

**Design limits approach** - A method of applying population or sample statistics and data about human physical characteristics to a design so that a desired portion of the user population is accommodated by the design. The range of users accommodated is a function of limits used in setting the population portion.

**Distal** - Away from the trunk (torso).

**Dynamic strength** - A force exerted by limbs moving in a smooth manner over time, such as while lifting an object.

**Ectocanthus** - The outside corner of the right eye formed by the meeting of the upper and lower eyelids. (Plural of ectocanthus is ectocanthi).

**Elevation** - The raising of a body member from a normal position.

**Explosive strength** - The application of peak amounts of strength for short periods of time, usually periodically, such as in running or sprinting.

**Extension** - The straightening of a limb or an increase in the angle between parts of the body.

**Flexion** - The process of bending a limb or decreasing the angle between parts of the body.

**Frankfort plane** - A standard horizontal plane or orientation of the head. It is established by a line passing through the tragion (the cartilaginous notch at the front of the ear) and the lowest point of the eye socket.

**Glabella** - The most anterior point of the forehead between the brow-ridges.

**Human physical and associated measurement characteristics** - Refers to specific physical, mobility, or strength features of human users and to the explicit way that a human feature or capability is measured for use as general anthropometric or biomechanics data or as data for a specific design.

**Lateral** - Away from the midline of the body.

**Lateral rotation** - Rotation away from the midline of the body.

**Medial rotation** - Turning toward the midline of the body.

**Menton** - The tip of the chin.

**Metacarpal** - The bones of the part of the hand between the carpus and the phalanges that typically contains five more or less elongated, cylindrical bones when all the digits are present.

**Metacarpal-phalangeal joints** - The joints between the metacarpals and the phalanges.

**Metacarpus** - The intermediate part of the hand skeleton that is located between the fingers and the carpus which forms the connection to the forearm.

**Occiput** - The back of the head.

**Olecranon (below and rear)** - The lowest and rearmost points of the right elbow with the elbow flexed 90 degrees.

**Omphalion** - The waist at the point of the navel.

**Percentile statistic** - Determined by ranking all data values (using the applicable measurement values related to the selected human physical characteristic) in the sample and determining the percentage of data that fall at or below a specific datum value.

**Percentile value (or point) of the selected datum** - The percentage of data that fall at or below a specific datum value.

**Phalanges** - The name commonly given to the bones that form the fingers and toes.

**Pronasale** - The tip of the nose.

**Pronation** - The downward turning of the palm.

**Proximal** - Closer to the trunk (torso).

**Proximal interphalangeal joint** - The joints between the first and second phalanges.

**Seat reference point** - A point in the mid-sagittal plane where the seat back and seat pan intersect.

**Sellion** - The nasal root depression between the eyes.

**Static strength** - Also known as isometric strength, which is steady force exerted while the limbs are in a stationary or static position.

**Stomion** - The midpoint of the lips.

**Stylian** - The most distal point on the styloid process of the radius.

**Supination** - The upward turning of the palm, or lying face up.

**Suprasternale** - The lowest point of the notch in the upper edge of the breast bone.

**Tragion** - The cartilaginous notch at the front of the ear.

**Tremor** - The oscillation of a body extremity which may occur along with an effort to maintain a fixed position or direction. The degree of tremor is measured by the distance or number of departures from the fixed path or position per unit of time. A tremor increases when (1) effort is made not to tremble and (2) fatigue is present. It is greatest in vertical motion, less in front-to-back motion, and least in side-to-side motion.

**Trochanter** - One of the bony prominences on the upper end of the femur (the thigh bone). The greater trochanter, used in these measurements, is the broad, flat protrusion on the femur, at the upper end of its lateral surface.

**Ventral** - Toward the front of the body.

### References

- Bradt Miller, B., Hodge, B., Kristensen, S., & Mucher, M. (2008). *Anthropometric Survey of Federal Aviation Administration Technical Operations Personnel – 2006-2008*. Yellow Springs, OH: Anthrotech.
- Department of Defense. (1989). *Human engineering design criteria for military systems, equipment and facilities (MIL-STD-1472D)*. Philadelphia, PA: Navy Publishing and Printing Office.
- Department of Defense. (1990). *Human engineering performance requirements for systems (MIL-STD-1800A)*. Philadelphia, PA: Navy Publishing and Printing Office.
- Department of Defense. (1991). *Anthropometry of U.S. military personnel (DOD-HDBK-743A)*. Philadelphia, PA: Navy Publishing and Printing Office.
- Department of Defense. (1992). *Human factors engineering design for army materiel (MIL-HDBK-759B)*. Philadelphia, PA: Navy Publishing and Printing Office.
- Department of the Air Force. (1980). *Human factors engineering (AFSC DH 1-3)*. Wright-Patterson AFB, OH: ASD/ENESS.
- Israelski, E. W. (1977). *Human factors handbook for telecommunications product design*. Whippany, NJ: AT&T Bell Laboratories.
- Johnson, R. F. (1984). *Anthropometry of clothing of U.S. Army ground troops and combat vehicle crewmen (NRDEC 54-84/034)*. Natick, MA: United States Army Natick Research, Development, & Engineering.
- Kroemer, K. H. E., Kroemer, H. J., & Kroemer-Elbert, K. E. (1990). *Engineering physiology: Bases of human factors/ergonomics*. New York: Van Nostrand Reinhold.
- National Aeronautics and Space Administration. (1989). *Man-systems integration standards (NASA-STD-3000A)*. Houston, TX: National Aeronautics and Space Administration.
- Roebuck, J. A., Kroemer, K. H. E., & Thomson, W. G. (1975). *Engineering anthropometry methods*. New York: Wiley.
- Uniform Federal Accessibility Standard (UFAS). (1988). 41 CFR Ch 101 subpart 101-19.6 Appendix A. Available online from [www.access-board.gov](http://www.access-board.gov)

## Index

<b>A</b>	
Abduction.....	14-29
Adduction.....	14-29
Adjustable dimensions .....	14-5
Anthropometric and biomechanics data... 14-13	
Anthropometrics	
bivariate distribution data .....	14-12
correlation data.....	14-11, 14-12
distribution .....	14-11
representative sample.....	14-4
rule information .....	14-4
variability factors .....	14-13
Anthropometry .....	14-1
<b>B</b>	
Biomechanics.....	14-1
Bivariate distribution data.....	14-12
Body slump.....	14-13
<b>C</b>	
Carrying .....	14-52
Circumduction.....	14-29
Clearance dimension.....	14-5
Control force limits.....	14-43
Correlation coefficient or "r" value .....	14-12
Correlation data, use of.....	14-12
Critical life support equipment .....	14-5
<b>D</b>	
Data usage.....	14-13
Depression.....	14-29
Design errors.....	14-6
Design limits .....	14-4
Direction of force	
horizontal .....	14-47
vertical.....	14-48
Dynamic (mobile) body characteristics	14-28
Dynamic dimensions.....	14-13
<b>E</b>	
Effects of clothing.....	14-9
Elevation.....	14-29
Exerted forces .....	14-43
Extension.....	14-29
<b>F</b>	
Flexion .....	14-29
Foreign populations .....	14-13
<b>G</b>	
Gaussian distribution .....	14-11
<b>H</b>	
Human strength and handling capacity	14-42
muscle strength factors .....	14-42
push and pull forces .....	14-47
<b>J</b>	
Joint motion .....	14-29
<b>L</b>	
Lateral rotation.....	14-29
Lifting .....	14-52
Lifting and carrying limits .....	14-52
Limiting dimension.....	14-5
<b>M</b>	
Medial rotation.....	14-29
Mobile body characteristics .....	<i>See</i> Dynamic body characteristics
Multiple correlation data, use of.....	14-12
<b>P</b>	
Population extremes	
use of.....	14-3
Pronation.....	14-29
<b>R</b>	
Range of motion.....	14-33
Reach.....	14-35
wheelchair .....	14-52, 14-53, 14-55
Reach envelope .....	14-37
Reach envelope data .....	14-8, 14-36

<b>S</b>		Thumb and forefinger grasp..... 14-39
Seat reference point..... 14-36		Tremor..... 14-46
Sizing determinations..... 14-5		Trunk movement..... 14-28
Static dimensions ..... 14-13		
Strength		<b>U</b>
comparative..... 14-46		User population..... 14-2
dynamic..... 14-42		
explosive ..... 14-42		<b>V</b>
female..... 14-42		Variability factors ..... 14-13
static ..... 14-42		
values ..... 14-45		<b>W</b>
Supination ..... 14-29		Wheelchair anthropometrics ..... 14-52
		Whole body motion..... 14-28
<b>T</b>		
Task considerations..... 14-14, 14-35		