



Economic and Social
Council

Distr.

GENERAL

ECE/TRANS/WP.29/GRB/2009/...

ENGLISH

ECONOMIC COMMISSION FOR EUROPE

INLAND TRANSPORT COMMITTEE

World Forum for Harmonization of Vehicle Regulations

Working Party on Noise (GRB)

50th session

Geneva, 1 September – 3 September 2009

Agenda item title

Subtitle

Title of the document

Proposal for draft amendments to Regulation No. 41 (i.e. Proposal for 04 series of amendments to Regulation No. 41)

Submitted by the Informal Group on Regulation 41*/

The text reproduced below was prepared by the Informal Group on Regulation 41 in order to introduce new provisions for improved noise control of motor cycles. It is based on a document without a symbol (informal document No. GRB-48-01) distributed at the 48th GRB session and reflects the discussions in the Informal Group on Regulation No 41 and GRB to date. The proposed amendments are substantial so the text is presented as a consolidation with the main modifications to the existing text of the Regulation marked in **bold** characters.

*/ In accordance with the programme of work of the Inland Transport Committee for 2006-2010 (ECE/TRANS/166/Add.1, programme activity 02.4), the World Forum will develop, harmonize and update Regulations in order to enhance performance of vehicles. The present document is submitted in conformity with that mandate.

UNIFORM PROVISIONS CONCERNING THE APPROVAL
OF MOTOR CYCLES WITH REGARD TO NOISE

CONTENTS	<u>Page</u>
1. SCOPE	3
2. DEFINITIONS, TERMS AND SYMBOLS	3
3. APPLICATION FOR APPROVAL	6
4. MARKINGS	7
5. APPROVAL	8
6. SPECIFICATIONS	9
7. MODIFICATION AND EXTENSION OF THE APPROVAL OF THE MOTOR CYCLE TYPE OR OF THE TYPE OF EXHAUST OR SILENCING SYSTEM(S)	11
8. CONFORMITY OF PRODUCTION	11
9. PENALTIES FOR NON-CONFORMITY OF PRODUCTION	12
10. PRODUCTION DEFINITELY DISCONTINUED	12
11. NAMES AND ADDRESSES OF TECHNICAL SERVICES RESPONSIBLE FOR CONDUCTING APPROVAL TESTS, AND OF ADMINISTRATIVE DEPARTMENTS	12
12. TRANSITIONAL PROVISIONS	12

ANNEXES

Annex 1 – Communication concerning the approval or extension or refusal or withdrawal of approval of production definitely discontinued of a motor cycle type with regard to noise emitted by motor cycles pursuant to Regulation No. 41

Annex 2 – Arrangements of approval marks

Annex 3 – Methods and instruments for measuring the noise made by motor cycles

Annex 4 – Test track specifications

Annex 5 – Exhaust system (silencer)

Annex 6 – Maximum limits of sound level

Annex 7 – Additional sound emission provisions

UNIFORM PROVISIONS CONCERNING THE APPROVAL
OF MOTOR CYCLES WITH REGARD TO NOISE

1. SCOPE

This Regulation applies to vehicles of category L3^{1/} with regard to noise.

2. DEFINITIONS, TERMS AND SYMBOLS

For the purpose of this Regulation

2.1. "Approval of a motor cycle" means the approval of a motor cycle type with regard to noise;

2.2. "type of motor cycle as regards its sound level and exhaust system" means motor cycles which do not differ in such essential respects as the following:

2.2.1. – the type of engine (two-stroke or four-stroke, reciprocating piston engine or rotary-piston engine, number and capacity of cylinders, number and type of carburettors or injection systems, arrangement of valves, rated maximum net power and corresponding engine speed).

For rotary-piston engines the cubic capacity should be taken to be double of the volume of the chamber;

2.2.2. – transmission system, in particular the number and ratios of the gears;

2.2.3. – number, type and arrangement of exhaust systems

2.3. "Exhaust or silencing system" means a complete set of components necessary to limit the noise caused by a motor cycle engine.

2.3.1. "Original exhaust or silencing system" means a system of a type fitted to the vehicle at the time of type-approval or extension of type-approval. It may also be the vehicle manufacturer's replacement part.

2.3.2. "Non-original exhaust or silencing system" means a system of a type other than that fitted to the vehicle at the time of type-approval or extension of type-approval.

2.4. "Exhaust or silencing systems of differing types" means systems which are fundamentally different in one of the following ways:

2.4.1. – systems comprising components bearing different factory or trade marks;

2.4.2. – systems comprising any component made of materials of different characteristics or comprising components which are of a different shape or size;

^{1/} As defined in the Consolidated Resolution on the Construction of Vehicles (R.E.3), Annex 7 (documents TRANS/WP.29/78/Rev.1/Amend.2 and Amend.4).

2.4.3. – systems in which the operating principles of at least one component are different;

2.4.4. – systems comprising components in different combinations.

2.5. “Component of an exhaust or silencing system” means one of the individual components which together form the exhaust system (such as exhaust pipework, the silencer proper) and the intake system (air filter) if any.

If the engine has to be equipped with an intake system (air filter and/or intake noise absorber) in order to comply with the maximum permissible sound levels, the filter and/or absorber must be treated as components having the same importance as the exhaust system.

2.6. “Kerb mass” (as defined in section 4.1.2 of ISO 6726: 1988) means the mass of the vehicle ready for normal operation and fitted with the following equipment:

- full electrical equipment including the lighting and signaling devices supplied by the manufacturer;
- all instruments and fittings required by any legislation in respect of which a measurement of the vehicle dry mass is being made;
- full complement of liquids to ensure the correct functioning of every part of the vehicle and the fuel tank filled at least to 90 % of the capacity specified by the manufacturer
- auxiliary equipment usually supplied by the manufacturer in addition to that necessary for normal operation (tool-kit, carrier(s), windscreen(s), protective equipment, etc.

NOTE - In the case of a vehicle which operates on a fuel/oil mixture,

- a) where the fuel and oil are pre-mixed, the word "fuel" is interpreted as including such pre-mixture of fuel and oil;
- b) where the fuel and oil are separately metered, the word "fuel" is interpreted as including only the petrol. [The "oil", in this case, is already included in the measurement of vehicle dry mass (see 4.1.1).]”

2.7. “Rated maximum net power” means the rated engine power as defined in ISO 4106:2004.

The symbol P_n denotes the numerical value of the rated maximum net power expressed in kilowatts.

2.8. “Rated engine speed” means the engine speed at which the engine develops its rated maximum net power as stated by the manufacturer.

The symbol S denotes the numerical value of the rated engine speed expressed in revolutions per minute.

Note: If the rated maximum net power is reached at several engine speeds, S is used in this Regulation as the highest engine speed at which the rated maximum net power is reached.

- 2.9. “Power-to-mass ratio index” means the ratio of the rated maximum net power of a vehicle to its mass. It is defined as:

$$PMR = \frac{P_n}{m_{kerb} + 75} \times 1000$$

where m_{kerb} is the numerical value of the kerb mass as defined in paragraph 2.6 above, expressed in kilograms.

The symbol PMR denotes the power-to-mass ratio index.

- 2.10. “Maximum speed” means the maximum vehicle speed as defined in ISO 7117:1995.

The symbol v_{max} denotes the maximum speed.

- 2.11. “Locked gear” means the control of the transmission such that the transmission gear ratio cannot change during a test.

- 2.12. “Engine” means the power source of the vehicle without detachable accessories.

- 2.13. Following is a table containing all symbols used in this Regulation:

Symbol	Units	Explanation	Reference
AA'	–	virtual line on the test track	annex 4 – Figure 1
a_{wot}	ms^{-2}	calculated acceleration	annex 3 – 1.4.2.
$a_{wot,ref}$	ms^{-2}	prescribed reference accel.	annex 3 – 1.3.3.3.1.2.
a_{urban}	ms^{-2}	prescribed target accel.	annex 3 – 1.3.3.3.1.2.
BB'	–	virtual line on the test track	annex 4 – Figure 1
CC'	–	virtual line on the test track	annex 4 – Figure 1
k	–	gear weighting factor	annex 3 – 1.4.3.
k_p	–	partial power factor	annex 3 – 1.4.4.
L	dB(A)	sound pressure level	annex 3 – 1.4.1.
l_{PA}	m	pre-acceleration length	annex 3 – 1.3.3.1.1.
m_{kerb}	kg	kerb mass of the vehicle	2.6.
m_t	kg	test mass of the vehicle	annex 3 – 1.3.2.2.
n	min^{-1}	measured engine speed	–
n_{idle}	min^{-1}	engine speed at idle	–
$n_{wot(i)}$	min^{-1}	$n_{PP'}$ corresponding to $L_{wot(i)}$	annex 7 – 2.6.
PP'	–	virtual line on the test track	annex 4 – Figure 1
PMR	–	power-to-mass ratio index	2.9.
P_n	kW	rated maximum net power	2.7.

S	min^{-1}	rated engine speed	2.8.
v	km/h	measured vehicle speed	–
v_{max}	km/h	maximum speed	2.10.
v_{test}	km/h	prescribed test speed	annex 3 – 1.3.3.1.1.

The following indices are used for measured engine speeds n and vehicle speeds v to indicate the location or rather time of the measurement:

- “AA” denoting that the measurement corresponds to the point in time when the front of the vehicle passes the line AA’ (see annex 4 – Figure 1); or
- “PP” denoting that the measurement corresponds to the point in time when the front of the vehicle passes the line PP’ (see annex 4 – Figure 1); or
- “BB” denoting that the measurement corresponds to the point in time when the rear of the vehicle passes the line BB’ (see annex 4 – Figure 1).

The following indices are used for calculated full throttle accelerations a_{wot} and measured sound pressure levels L to indicate the gear used for the test:

- “(i)” denoting, in the case of a two-gear test, the lower gear (i.e. the gear with the higher gear transmission ratio) and otherwise referring to the single test gear or gear selector position used; or
- “(i+1)” denoting, in the case of a two-gear test, the higher gear (i.e. the gear with the lower gear transmission ratio).

Measured sound pressure levels L also carry an index indicating the type of the respective test:

- “wot” denoting a full throttle acceleration test (see paragraph 1.3.3.1.1. of annex 3); or
- “crs” denoting a constant speed test (see paragraph 1.3.3.3.2. of annex 3); or
- “urban” denoting a weighted combination of a constant speed test and a full throttle acceleration test (see paragraph 1.4.6.2. of annex 3).

The index “j” referring to the number of the test run can be used in addition to the indices mentioned above.

3. APPLICATION FOR APPROVAL

3.1. The application for approval of a motor cycle type with regard to its sound emissions shall be submitted by its manufacturer or by his duly accredited representative.

3.2. It shall be accompanied by the undermentioned documents in triplicate and the following particulars:

- 3.2.1. – a description of the motor cycle type with regard to the items mentioned in paragraph 2.2. above. The numbers and/or symbols identifying the engine type and the motor cycle type shall be specified;
 - 3.2.2. – a list of the components, duly identified, constituting the exhaust or silencing system;
 - 3.2.3. – a drawing of the assembled exhaust or silencing system and an indication of its position on the motor cycle;
 - 3.2.4. – drawings of each component to enable it to be easily located and identified, and a specification of the materials used;
 - 3.2.5. – cross-sectional drawings indicating the dimensions of the exhaust system. A copy of these drawings shall be appended to the certificate referred to in annex 1.
- 3.3. At the request of the technical service responsible for conducting approval tests, the motor cycle manufacturer shall, in addition, submit a sample of the exhaust or silencing system.
- 3.4. A motor cycle representative of the motor cycle type to be approved shall be submitted to the technical service responsible for conducting approval tests.

4. MARKINGS

- 4.1. The components of the exhaust or silencing system shall bear at least the following identifications:
- 4.1.1. – the trade name or mark of the manufacturer of the exhaust or silencing system and of its components;
 - 4.1.2. – the trade description given by the manufacturer;
 - 4.1.3. – the identifying part numbers; and
 - 4.1.4. – for all original silencers, the ‘E’ mark followed by the identification of the country which granted the component type-approval^{1/}.
- 4.1.5. Any packing of original replacement exhaust or silencing systems must be marked legibly with the words ‘original part’ and the make and type references

^{1/} 1 for Germany, ... 24 for Ireland, ... 27 for Slovakia, 28 for Belarus, 29 for Estonia, 30 (vacant), 31 for Bosnia and Herzegovina, 32 for Latvia, 33 (vacant), 34 for Bulgaria, 35-36 (vacant), 37 for Turkey, 38-39 (vacant), 40 for the former Yugoslav Republic of Macedonia, 41 (vacant), 42 for the European Community (Approvals are granted by its Member States using their respective ECE symbol), 43 for Japan, 44 (vacant), 45 for Australia and 46 for Ukraine. Subsequent numbers shall be assigned to other countries in the chronological order in which they ratify the Agreement Concerning the Adoption for Uniform Technical Prescriptions for Wheeled Vehicles, Equipment and Parts which can be fitted and/or be Used on Wheeled Vehicles, and the Conditions for Reciprocal Recognition of Approval Granted on the Basis of these Prescriptions, and the numbers thus assigned shall be communicated by the Secretary-General of the United Nations to the Contracting Parties to the Agreement.

integrated together with the 'E' mark and also the reference of the country of origin.

4.1.6. Such markings shall be indelible, clearly legible and also visible, in the position at which it is to be fitted to the vehicle.

5. APPROVAL

5.1. If the motor cycle type submitted for approval pursuant to this Regulation meets the requirements of paragraphs 6. and 7. below, approval of that motor cycle type shall be granted.

5.2. An approval number shall be assigned to each type approved. Its first two digits indicate the series of amendments incorporating the most recent major technical amendments made to the Regulation at the time of issue of the approval. The same Contracting Party may not assign the same number to the same motor cycle type equipped with another type of exhaust or silencing system, or to another motor cycle type.

5.3. Notice of approval or of refusal of approval of a motor cycle type pursuant to this Regulation shall be communicated to the Parties to the Agreement which apply this Regulation, by means of a form conforming to the model in annex 1 to this Regulation and of drawings of the exhaust or silencing system, supplied by the applicant for approval in a format not exceeding A4 (210 x 297 mm) or folded to that format and on an appropriate scale.

5.4. There shall be affixed, conspicuously and in a readily accessible place specified on the approval form, to every motor cycle conforming to a motor cycle type approved under this Regulation an international approval mark consisting of:

5.4.1. – a circle surrounding the letter "E" followed by the distinguishing number of the country which has granted approval;^{1/} and

5.4.2. – the number of this Regulation, followed by the letter "R", a dash and the approval number to the right of the circle prescribed in paragraph 5.4.1..

5.5. If the motor cycle conforms to a motor cycle type approved, under one or more other Regulations annexed to the Agreement, in the country which has granted approval under this Regulation, the symbol prescribed in paragraph 5.4.1. need not be repeated; in such a case the Regulation and approval numbers and the

^{1/} 1 for Germany, ... 24 for Ireland, ... 27 for Slovakia, 28 for Belarus, 29 for Estonia, 30 (vacant), 31 for Bosnia and Herzegovina, 32 for Latvia, 33 (vacant), 34 for Bulgaria, 35-36 (vacant), 37 for Turkey, 38-39 (vacant), 40 for the former Yugoslav Republic of Macedonia, 41 (vacant), 42 for the European Community (Approvals are granted by its Member States using their respective ECE symbol), 43 for Japan, 44 (vacant), 45 for Australia and 46 for Ukraine. Subsequent numbers shall be assigned to other countries in the chronological order in which they ratify the Agreement Concerning the Adoption for Uniform Technical Prescriptions for Wheeled Vehicles, Equipment and Parts which can be fitted and/or be Used on Wheeled Vehicles, and the Conditions for Reciprocal Recognition of Approval Granted on the Basis of these Prescriptions, and the numbers thus assigned shall be communicated by the Secretary-General of the United Nations to the Contracting Parties to the Agreement.

additional symbols of all the Regulations under which approval has been granted in the country which has granted approval under this Regulation shall be placed in vertical columns to the right of the symbol prescribed in paragraph 5.4.1..

- 5.6. The approval mark shall be clearly legible and be indelible.
- 5.7. The approval mark shall be placed close to or on the motor cycle data plate affixed by the manufacturer.
- 5.8. Annex 2 to this Regulation gives examples of arrangements of the approval mark.
- 5.9. The test report shall at least include the following information:
 - details of the test site (e.g. surface temperature, absorption coefficient etc.), test site location, site orientation and weather conditions including wind speed and air temperature, direction, barometric pressure, humidity;
 - the type of measuring equipment including the windscreen;
 - the A-weighted sound pressure level typical of the background noise;
 - the identification of the vehicle, its engine, its transmission system, including available transmission ratios, size and type of tyres, tyre pressure, tyre production type, rated maximum net power, test mass, power to mass ratio index, $a_{\text{wot ref}}$, a_{urban} , vehicle length;
 - the transmission gears or gear ratios used during the test;
 - the vehicle speed and engine speed at the beginning of the period of acceleration and the location of the beginning of the acceleration per gear used;
 - the vehicle speed and engine speed at PP' and at the end of the acceleration per valid measurement;
 - the method used for calculation of the acceleration;
 - the intermediate measurement results $a_{\text{wot}(i)}$, $a_{\text{wot}(i+1)}$, $L_{\text{wot}(i)}$, $L_{\text{wot}(i+1)}$, $L_{\text{crs}(i)}$ and $L_{\text{crs}(i+1)}$, if applicable;
 - the weighting factors k and k_p and the final measurement results L_{wot} , L_{crs} and L_{urban} ;
 - the auxiliary equipment of the vehicle, where appropriate, and its operating conditions;
 - all valid A-weighted sound pressure level values measured for each test, listed according to the side of the vehicle and the direction of the vehicle movement on the test site; and
 - all relevant information necessary to obtain the different sound emission levels.

6. SPECIFICATIONS

6.1. General specifications

6.1.1. The following information shall be provided on the motor cycle in an easily accessible but not necessarily immediately visible location:

- the manufacturer's name;
- the target engine speed and the final result of the stationary test as defined in section 2. of annex 3. to this Regulation; **[and**

1

- **the in-use compliance reference data as defined in section 3. of annex 3 to this Regulation.]**

6.2. Specifications regarding sound levels

6.2.1. The sound emissions of the motor cycle type submitted for approval shall be measured by the two methods described in annex 3 to this Regulation (motor cycle in motion and motor cycle when stationary).^{2/}

6.2.2. The test results obtained in accordance with the provisions of paragraph 6.2.1. above shall be entered in the test report and on a form conforming to the model in annex 1 to this Regulation.

6.2.3. The test results for the motor cycle in motion obtained in accordance with section 1. of annex 3 to this Regulation and mathematically rounded to the nearest integer shall not exceed the limits prescribed (for new motor cycles and new exhaust or silencing systems) in annex 6 to this Regulation for the category to which the motor cycle belongs.

6.3. Additional sound emission provisions

6.3.1. The vehicle manufacturer shall not intentionally alter, adjust, or introduce any device or procedure solely for the purpose of fulfilling the noise emission requirements of this Regulation, which will not be operational during typical on-road operation.

6.3.2. **In the application for type approval or for modification or extension of a type approval the manufacturer shall provide a statement, as set out in the Appendix to Annex 7 of this Regulation, that the vehicle type to be approved complies with:**

2

- **the requirements of paragraphs 6.3.1. of this Regulation**
- **the requirements of Annex 7 of this Regulation.**

6.3.3. **The competent authority may carry out any test prescribed in this Regulation.**

6.3.2. **The vehicle type to be approved shall meet the requirements of annex 7 of this Regulation.**

^{2/} A test is made on a stationary motor cycle in order to provide a reference value for administrations which use this method to check motor cycles in use.

- 6.3.3. In the application for type approval or for modification or extension of a type approval the manufacturer shall provide a statement that the vehicle type to be approved complies with the requirements of paragraphs 6.3.1. and 6.3.2. of this Regulation.**
- 6.3.4. The competent authority may carry out any test prescribed in this Regulation.**
- 6.4. Additional specifications regarding exhaust or silencing systems filled with fibrous material
- 6.4.1. If the exhaust or silencing system of the motor cycle contains fibrous materials the requirements of annex 5 shall apply. If the intake of the engine is fitted with an air filter and/or an intake-noise absorber which is (are) necessary in order to ensure compliance with the permissible sound level, the filter and/or absorber shall be considered to be part of the silencing system, and the requirements of annex 5 shall also apply to them.
- 6.5. Additional prescriptions related to tamperability and manually adjustable multi-mode exhaust or silencing systems
- 6.5.1. All exhaust or silencing systems shall be constructed in a way that does not easily permit removal of baffles, exit-cones and other parts whose primary function is as part of the silencing/expansion chambers. Where incorporation of such a part is unavoidable, its method of attachment shall be such that removal is not facilitated easily (e.g. with conventional threaded fixings) and should also be attached such that removal causes permanent/ irrecoverable damage to the assembly.
- 6.5.2. Exhaust or silencing systems with multiple, manually adjustable operating modes shall meet all requirements in all operating modes. The reporting noise levels shall be those resulting from the mode with the highest noise levels.
7. MODIFICATION AND EXTENSION OF THE APPROVAL OF THE MOTOR CYCLE TYPE OR OF THE TYPE OF EXHAUST OR SILENCING SYSTEM(S)
- 7.1. Every modification of the motor cycle type or of the exhaust or silencing system shall be notified to the type approval authority which approved the motor cycle type. The type approval authority may then either:
- 7.1.1. – consider that the modifications made are unlikely to have appreciable adverse effects, and that in any case the motor cycle still complies with the requirements of this Regulation; or
- 7.1.2. – require a further test report from the technical service responsible for conducting the tests.
- 7.2. Confirmation or refusal of approval, specifying the alterations, shall be communicated by the procedure specified in paragraph 5.3. above to the Parties to the Agreement which apply this Regulation.

7.3. The competent authority which issued the approval extension shall assign a serial number to the extension and shall so notify the other Parties to the 1958 Agreement applying this Regulation, by means of a communication form conforming to the model in annex 1 to this Regulation.

8. CONFORMITY OF PRODUCTION

The conformity of production procedures shall comply with those set out in the Agreement, appendix 2 (E/ECE/324-E/ECE/TRANS/505/Rev.2), with the following requirements:

- 8.1. – Any motor cycle manufactured must conform to a type of motor cycle approved pursuant to this Regulation, be equipped with the silencer with which it was type-approved and satisfy the requirements of paragraph 6 above.
- 8.2. – In order to test conformity as required above, a sample motor cycle will be taken from the production line of the motor cycle type approved pursuant to this Regulation. Its sound levels measured and processed (L_{urban} and L_{wot}) according to the method described in annex 3, with the same gear(s) and pre-acceleration distance(s) as used in the original type approval test, and mathematically rounded to the nearest integer shall not exceed by more than 3.0 dB(A) the values measured and processed at the time of type-approval, nor by more than 1.0 dB(A) the limits laid down in annex 6 of this Regulation.
- 8.3. – For conformity of production, the manufacturer shall make a renewed declaration that the type still fulfils the requirements of paragraphs 6.3.1. and 6.3.2. of this Regulation.

9. PENALTIES FOR NON-CONFORMITY OF PRODUCTION

9.1. The approval granted in respect of a motor cycle type pursuant to this Regulation may be withdrawn if the requirements laid down in paragraph 8 above are not met.

9.2. If a Party to the Agreement which applies this Regulation withdraws an approval it has previously granted, it shall forthwith so notify the other Contracting Parties applying this Regulation by means of a communication form conforming to the model in annex 1 to this Regulation.

10. PRODUCTION DEFINITELY DISCONTINUED

If the holder of the approval completely ceases to manufacture a type of a motor cycle approved in accordance with this Regulation, he shall inform the authority which granted the approval. Upon receiving the relevant communication, that authority shall inform thereof the other Parties to the Agreement applying this Regulation by means of a communication form conforming to the model in annex 1 to this Regulation.

11. NAMES AND ADDRESSES OF TECHNICAL SERVICES RESPONSIBLE FOR CONDUCTING APPROVAL TESTS, AND OF ADMINISTRATIVE DEPARTMENTS

The Parties to the 1958 Agreement applying this Regulation shall communicate to the United Nations Secretariat the names and addresses of the technical services responsible for conducting approval tests and of the administrative departments which grant approval and to which forms certifying approval or extension or refusal or withdrawal of approval, issued in other countries, are to be sent.

12. TRANSITIONAL PROVISIONS

- 12.1. As from the official date of entry into force of the 04 series of amendments, no Contracting Parties applying this Regulation shall refuse to grant ECE approval under this Regulation as amended by the 04 series of amendments.
- 12.2. As from [24] months after the date of entry into force of the 04 series of amendments, Contracting Parties applying this Regulation shall grant ECE approvals only if the motor cycle type to be approved meets the requirements of this Regulation as amended by the 04 series of amendments.
- 12.3. Contracting Parties applying this Regulation shall not refuse to grant extensions of approval in accordance with the preceding series of amendments to this Regulation.
- 12.4. Contracting Parties applying this Regulation shall continue to grant approvals to those types of motor cycles which conform to the requirements of this Regulation as amended by the preceding series of amendments until the entry into force of the 04 series of amendments.
- 12.5. ECE approvals granted under this Regulation before the entry into force of the 04 series of amendments and all extensions of such approvals, including those granted subsequently under a preceding series of amendments to this Regulation, shall remain valid indefinitely. If the motor cycle type approved under the preceding series of amendments meets the requirements of this Regulation as amended by the 04 series of amendments, the Contracting Party which granted the approval shall so notify the other Contracting Parties applying this Regulation.
- 12.6. No Contracting Party applying this Regulation shall refuse national type approval of a motor cycle type approved under the 04 series of amendments to this Regulation or meeting the requirements thereof.
- 12.7. As from [48] months after the date of entry into force of the 04 series of amendments, Contracting Parties applying this Regulation may refuse first national registration (first entry into service) of a motor cycle which does not meet the requirements of the 04 series of amendments to this Regulation.

Annex 1

COMMUNICATION

(Maximum format: A4 (210 x 297 mm))

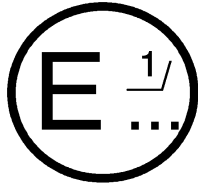

issued by: Name of administration:

.....
.....
.....

concerning: 2/ APPROVAL GRANTED

APPROVAL EXTENDED

APPROVAL REFUSED

APPROVAL WITHDRAWN

PRODUCTION DEFINITELY DISCONTINUED

of a motor cycle type with regard to noise emitted by motor cycles pursuant to Regulation No. 41

Approval No.

Extension No.

-
1. Trade name or mark of the motor cycle:
 2. Motor cycle type:
 3. Manufacturer's name and address:
 4. If applicable, name and address of manufacturer's representative:
.....
 5. Engine
 - 5.1. Manufacturer:
 - 5.2. Type:
 - 5.3. Model:

- 5.4. Rated maximum net power: kW at min⁻¹ (rpm).
- 5.5. Kind of engine (e.g. positive-ignition, compression ignition, etc.): 3/
.....
- 5.6. Cycles: two-stroke / four-stroke 2/
- 5.7. Cylinder capacity: cm³
- 6. Transmission
- 6.1. Type of transmission: non-automatic gearbox / automatic gearbox 2/
- 6.2. Number of gears:
- 7. Equipment
- 7.1. Exhaust silencer
- 7.1.1. Manufacturer or authorized representative (if any):
- 7.1.2. Model:
- 7.1.3. Type:..... in accordance with drawing No.:
- 7.2. Intake silencer
- 7.2.1. Manufacturer or authorized representative (if any):
- 7.2.2. Model:
- 7.2.3. Type:..... in accordance with drawing No.:
- 8. Gears used for test of motor cycle in motion:
- 9. Final drive ratio(s):
- 10. Type and dimensions of tyres:
- 11. Masses
- 11.1. Maximum permissible gross weight: kg
- 11.2. Test mass: kg
- 11.3. Power to mass ratio index (*PMR*):
- 12. Vehicle length: m
- 13. Vehicle speeds of measurements in gear (i)
- 13.1. Vehicle speed at the beginning of the period of acceleration
(average of 3 runs) for gear (i): km/h
- 13.2. Pre-acceleration length for gear (i): m
- 13.3. Vehicle speed v_{PP} (average of 3 runs) for gear (i): km/h

- 13.4. Vehicle speed $v_{BB'}$ (average of 3 runs) for gear (i): km/h
14. Vehicle speeds of measurements in gear (i+1) (if applicable)
 - 14.1. Vehicle speed at the beginning of the period of acceleration (average of 3 runs) for gear (i+1): km/h
 - 14.2. Pre-acceleration length for gear (i+1): m
 - 14.3. Vehicle speed $v_{PP'}$ (average of 3 runs) for gear (i+1): km/h
 - 14.4. Vehicle speed $v_{BB'}$ (average of 3 runs) for gear (i+1): km/h
15. Accelerations are calculated between lines AA' and BB' / PP' and BB' 2
16. Noise levels of moving vehicle
 - 16.1. Wide-open-throttle test result L_{wot} : dB(A)
 - 16.2. Constant speed test results L_{crs} : dB(A)
 - 16.3. Partial power factor k_p :
 - 16.4. Final test result L_{urban} : dB(A)
17. Noise level of stationary vehicle
 - 17.1. Position and orientation of microphone (according to Figure 1 in appendix B of annex 3):
 - 17.2. Test result for stationary test: dB(A) at rpm
18. Additional sound emission provisions:
See manufacturer's statement of compliance (attached)
19. In-use compliance reference data
 - 19.1. Gear (i) or, for vehicles tested with non-locked gear ratios, the position of the gear selector chosen for the test:
 - 19.2. Pre-acceleration length l_{pA} : m
 - 19.3. Vehicle speed at the beginning of the period of acceleration (average of 3 runs) for gear (i): km/h
 - 19.4. Sound pressure level $L_{wot(i)}$: dB(A)
20. Deviations in calibration of sound level meter: dB(A)
21. Date of submission for approval of the motor cycle:
22. Technical service responsible for conducting the approval tests:
23. Date of report issued by that service:
24. Number of report issued by that service:

25. Approval granted/extended/refused/withdrawn 2/
26. Position of approval mark on the motor cycle:
27. Place:
28. Date:
29. Signature:
30. The following documents, bearing the approval number shown above, are annexed to this communication:
 - ...drawings, diagrams and plans of the engine and of the noise reduction system;
 - ...photographs of the engine and of the exhaust or silencing system;
 - ...list of components, duly identified constituting the noise reduction system.

1/ Distinguishing number of the country which has granted / extended / refused / withdrawn approval (see approval provisions in the Regulation).

2/ Strike out what does not apply.

3/ If a non-conventional engine is used, this should be stated.

Annex 2

ARRANGEMENTS OF APPROVAL MARKS

Model A

(See paragraph 5.4. of this Regulation)



$a = 8 \text{ mm min.}$

The above approval mark affixed to a motor cycle shows that the motor cycle type concerned has, with regard to noise, been approved in the Netherlands (E 4) pursuant to Regulation No. 41 under approval number 042439. The first two digits of the approval number indicate that the approval was granted in accordance with the requirements of Regulation No. 41 as amended by the 04 series of amendments.

Model B

(See paragraph 5.5 of this Regulation)

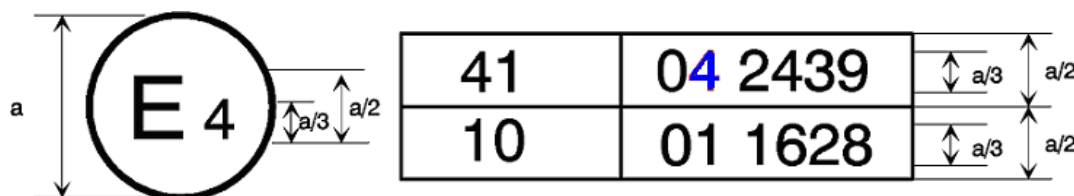

$a = 8 \text{ mm min.}$

The above approval mark affixed to a motor cycle shows that the motor cycle type concerned has been approved in the Netherlands (E 4) pursuant to Regulations Nos. 41 and 10. */ The first two digits of the approval numbers indicate that on the date on which these approvals were granted, Regulation No. 41 included 04 series of amendments and Regulation No. 10 included the 01 series of amendments.

*/ The second number is given merely as an example.

Annex 3

METHODS AND INSTRUMENTS FOR MEASURING
NOISE MADE BY MOTOR CYCLES

1. Noise of the motor cycle in motion (measuring conditions and method for testing of the vehicle during component type approval).

1.1. Measuring instruments

1.1.1. Acoustic measurements

1.1.1.1. General

The apparatus used for measuring the sound pressure level shall be a sound level meter or equivalent measuring system meeting the requirements of Class 1 instruments (inclusive of the recommended windscreen, if used). These requirements are described in IEC 61672-1:2002.

Measurements shall be carried out using the time weighting "F" of the acoustic measuring instrument and the "A" frequency weighting curve also described in IEC 61672-1:2002. When using a system that includes periodic monitoring of the A-weighted sound pressure level, a reading should be made at a time interval not greater than 30 ms.

The instruments shall be maintained and calibrated in accordance to the instructions of the instrument manufacturer.

1.1.1.2. Calibration

At the beginning and at the end of every measurement session, the entire acoustic measuring system shall be checked by means of a sound calibrator that fulfils the requirements of Class 1 sound calibrators according to IEC 60942:2003. Without any further adjustment, the difference between the readings shall be less than or equal to 0.5 dB(A). If this value is exceeded, the results of the measurements obtained after the previous satisfactory check shall be discarded.

1.1.1.3. Compliance with requirements

Compliance of the sound calibrator with the requirements of IEC 60942:2003 shall be verified once a year. Compliance of the instrumentation system with the requirements of IEC 61672-1:2002 shall be verified at least every 2 years. All compliance testing shall be conducted by a laboratory which is authorized to perform calibrations traceable to the appropriate standards.

1.1.2. Instrumentation for speed measurements

The rotational speed of the engine shall be measured with an instrument meeting specification limits of at least ± 2 per cent or better at the engine speeds required for the measurements being performed.

The road speed of the vehicle shall be measured with instruments meeting specification limits of at least ± 0.5 km/h when using continuous measuring devices.

If testing uses independent measurements of speed, this instrumentation shall meet specification limits of at least ± 0.2 km/h.

Note: Independent measurements of speed are when two or more separate devices will determine the values of v_{AA} , v_{BB} and v_{PP} . A continuous measuring device such as radar will determine all required speed information with one device.

1.1.3. Meteorological instrumentation

The meteorological instrumentation used to monitor the environmental conditions during the test shall meet the following specifications:

± 1 °C or less for a temperature measuring device;

± 1.0 m/s for a wind speed measuring device;

± 5 hPa for a barometric pressure measuring device;

± 5 per cent for a relative humidity measuring device.

1.2. Acoustical environment, meteorological conditions and background noise

1.2.1. Test site

The test site shall consist of a central acceleration section surrounded by a substantially level test area. The acceleration section shall be level; its surface shall be dry and so designed that rolling noise remains low.

On the test site the variations in the free sound field between the sound source at the centre of the acceleration section and the microphone shall be maintained to within 1 dB(A). This condition will be deemed to be met if there are no large objects which reflect sound, such as fences, rocks, bridges or buildings, within 50 m of the centre of the acceleration section. The road surface covering of the test site shall conform to the requirements of annex 4.

The microphone shall not be obstructed in any way which could affect the sound field, and no person may stand between the microphone and the sound source. The observer carrying out the measurements shall take up position so as not to affect the readings of the measuring instrument.

1.2.2. Meteorological conditions

The meteorological instrumentation shall deliver data representative of the test site, and shall be positioned adjacent to the test area at a height representative of the height of the measuring microphone.

3

The measurements shall be made when the ambient air temperature is within the range from 5 °C to [40][45] °C. The tests shall not be carried out if the wind speed, including gusts, at microphone height exceeds 5 m/s, during the noise measurement interval.

A value representative of temperature, wind speed and direction, relative humidity and barometric pressure shall be recorded during the noise measurement interval.

1.2.3. Background noise

Any sound peak which appears to be unrelated to the characteristics of the general noise level of the vehicle shall be ignored in taking the readings.

The background noise shall be measured for a duration of 10 s immediately before and after a series of vehicle tests. The measurements shall be made with the same microphones and microphone locations used during the test. The maximum A-weighted sound pressure level shall be reported.

The background noise (including any wind noise) shall be at least 10 dB(A) below the A-weighted sound pressure level produced by the vehicle under test. If the difference between the background sound pressure level and the measured sound pressure level is between 10 dB(A) and 15 dB(A), in order to calculate the jth test result the appropriate correction shall be subtracted from the readings on the sound level meter, as given in Table 1.

Table 1: Correction applied to individual measured test value

Background sound pressure level difference to measured sound pressure level, in dB	10	11	12	13	14	≥ 15
Correction, in dB(A)	0.5	0.4	0.3	0.2	0.1	0.0

1.3. Test procedures

1.3.1. Microphone positions

The distance of the microphone positions from the line CC', on the microphone line PP', perpendicular to the reference line CC' on the test track (see annex 4 – Figure 1), shall be 7.5 m ± 0.05 m.

The microphones shall be located 1.2 m ± 0.02 m above the ground level. The reference direction for free-field conditions (see IEC 61672-1:2002) shall be horizontal and directed perpendicularly towards the path of the vehicle line CC'.

1.3.2. Conditions of the vehicle

1.3.2.1. General Conditions

The vehicle shall be supplied as specified by the vehicle manufacturer.

Before the measurements are started, the vehicle shall be brought to its normal operating conditions.

If the motor cycle is fitted with fans with an automatic actuating mechanism, this system shall not be interfered with during the sound measurements. For motor cycles having more than one driven wheel, only the drive provided for normal road operation may be used. If the motor cycle is fitted with a sidecar, this must be removed for the purposes of the test.

1.3.2.2. Test mass of the vehicle

Measurements shall be made on vehicles at the following test mass m_t , in kg, specified as:

$$m_t = m_{\text{kerb}} + 75 \text{ kg} \pm 5 \text{ kg} \text{ (75 kg} \pm 5 \text{ kg equates to mass of the driver)}$$

1.3.2.3. Tyre selection and condition

The tyres shall be appropriate for the vehicle and shall be inflated to the pressure recommended by the vehicle manufacturer for the test mass of the vehicle.

 The tyres shall be selected by the vehicle manufacturer, and correspond to one of the tyre sizes and types designated for the vehicle by the vehicle manufacturer. **The tyres shall be commercially available on the market at the same time as the vehicle.** The minimum tread depth shall be at least 80 per cent of the full tread depth.

1.3.3. Operating conditions

1.3.3.1. General operating conditions

The path of the centreline of the vehicle shall follow the line CC' as closely as possible throughout the entire test, from the approach to line AA' until the rear of the vehicle passes line BB' (see annex 4 – Figure 1).

1.3.3.1.1. For full throttle acceleration tests the vehicle shall approach the line AA' at constant speed. When the front of the vehicle passes the line AA' the throttle control shall be shifted to the maximum throttle position as rapidly as possible and kept in this position until the rear of the vehicle passes the BB'. At this moment the throttle control shall be shifted to the idle position as rapidly as possible.

Unless specified otherwise the manufacturer may choose to use pre-acceleration in a full throttle acceleration test for the purpose of achieving a stable acceleration between the lines AA' and BB'. A test with pre-acceleration proceeds as described above except for the fact that the throttle control is shifted to the maximum throttle position already before the vehicle passes the line AA', namely when the front of the vehicle is still at a distance l_{PA} , the pre-acceleration length, from the line AA'.

The approach velocity shall be chosen such that vehicle reaches a prescribed test speed v_{test} when its front passes the line PP'.

1.3.3.1.2. During constant speed tests, the acceleration control unit shall be positioned to maintain a constant vehicle speed between the lines AA' and BB'.

1.3.3.2. Operating conditions for vehicles with $PMR \leq 25$

The vehicle is tested in a full throttle acceleration test with the following specifications:

- The test speed shall be $v_{\text{test}} = 40 \text{ km/h} \pm 1 \text{ km/h}$.
- When the rear of the vehicle passes the line BB' the vehicle speed shall not exceed 75 per cent of the maximum vehicle speed as defined in paragraph 2.10 of this Regulation neither shall the engine speed exceed the rated engine speed.

The gear for the test shall be selected in the following iterative way:

The initial test speed shall be as specified above. The test speed shall be reduced by increments of 10 per cent of v_{test} (i.e. 4 km/h) in case the exit speed $v_{\text{BB}'}$ exceeds 75 per cent of v_{max} or in case the engine speed exceeds the rated engine speed S at BB'. The selected gear shall be the lowest one without exceeding the rated engine speed S during the test. The final test conditions are determined by the lowest possible gear at the highest possible test speed without exceeding either 75 per cent of v_{max} or the rated engine speed S at BB'.

To save testing time, the manufacturer may provide information on the iterative procedure for gear selection specified above.

A flow chart of the test procedure is given in appendix A to this annex.

1.3.3.3. Operating conditions for vehicles with $PMR > 25$

The vehicle is tested in a full throttle acceleration test and in a constant speed test.

1.3.3.3.1. Full throttle acceleration test

For the full throttle acceleration tests the test speed and the mean acceleration of the vehicle in the test track are specified.

The accelerations are not measured directly but calculated from measurements of the vehicle speed as described in paragraph 1.4. below.

1.3.3.3.1.1. Test speed

The test speed v_{test} shall be

40 km/h \pm 1 km/h for vehicles with a $PMR \leq 50$; and

50 km/h \pm 1 km/h for vehicles with a $PMR > 50$.

If, in a given gear, the exit speed $v_{\text{BB}'}$ exceeds 75 per cent of the maximum speed v_{max} of the vehicle, the test speed for test in this gear shall be

successively reduced by increments of 10 per cent of v_{test} (i.e. 4 km/h or 5 km/h) until the exit speed v_{BB} falls below 75 per cent of v_{max} .

1.3.3.3.1.2. Reference acceleration and target acceleration

During the full throttle acceleration tests the vehicle shall reach the reference acceleration $a_{\text{wot ref}}$ defined as

$$a_{\text{wot ref}} = 2.47 \times \log(PMR) - 2.52 \quad \text{for vehicles with a } PMR \leq 50; \text{ and}$$

$$a_{\text{wot ref}} = 3.33 \times \log(PMR) - 4.16 \quad \text{for vehicles with a } PMR > 50.$$

The results of these full throttle acceleration tests are used together with the results of constant speed tests to approximate a partial load acceleration typical for urban driving. The corresponding target acceleration a_{urban} is defined as

$$a_{\text{urban}} = 1.37 \times \log(PMR) - 1.08 \quad \text{for vehicles with a } PMR \leq 50; \text{ and}$$

$$a_{\text{urban}} = 1.28 \times \log(PMR) - 1.19 \quad \text{for vehicles with a } PMR > 50.$$

1.3.3.3.1.3. Gear selection

It is the responsibility of the manufacturer to determine the correct manner of testing to achieve the required test speed and acceleration.

1.3.3.3.1.3.1. Vehicles with manual transmissions, automatic transmissions, or transmissions with continuously variable transmission ratios (CVTs) tested with locked gears

The selection of gears for the test depends on the specific acceleration under full throttle in the various gears in relation to the reference acceleration $a_{\text{wot,ref}}$ required for the full-throttle acceleration tests according to paragraph 1.3.3.3.1.2. above.

The following conditions for the gear selection are possible:

a) If there are two gears (i) and (i+1) that give an acceleration in a tolerance band of ± 10 per cent of the reference acceleration $a_{\text{wot,ref}}$, both gears shall be used for the test;

1

a) If there are two gears (i) and (i+1) that give an acceleration in a tolerance band of ± 10 per cent of the reference acceleration $a_{\text{wot,ref}}$, gear (i) shall be used for the test;

b) If only one specific gear gives acceleration in the tolerance band of ± 10 per cent of the reference acceleration $a_{\text{wot,ref}}$, the test shall be performed with that gear;

c) If none of the gears gives the required acceleration to within ± 10 per cent of the reference acceleration $a_{\text{wot,ref}}$, then tests shall be performed in two adjacent gears (i) and (i+1) chosen such that the gear (i), gives an acceleration higher and the gear (i+1) an acceleration lower than the reference acceleration $a_{\text{wot,ref}}$.

2

If the rated engine speed is exceeded in a gear (i) before the vehicle passes BB', the next higher gear (i+1) shall be used.

If the rated engine speed is exceeded in a gear (i) before the vehicle passes BB', that gear shall be excluded from testing.

If the vehicle has more than one gear the first gear shall not be used. If $a_{\text{wot,ref}}$ can only be achieved in first gear, second gear shall be used.

- 1.3.3.3.1.3.2. Vehicles with automatic transmissions, adaptive transmissions or transmissions with variable transmission ratios tested with non-locked gears

The gear selector position for full automatic operation shall be used.

The test may then include a gear change to a lower gear and a higher acceleration. A gear change to a higher gear and a lower acceleration is not allowed. In any case, a gear change to a gear which is typically not used at the specified condition in urban traffic shall be avoided.

Therefore, it is permitted to establish and use electronic or mechanical devices, including alternative gear selector positions, to prevent a downshift to a gear which is typically not used at the specified test condition in urban traffic. If such devices are used, no pre-acceleration may be applied.

7

The achieved acceleration $a_{\text{wot},i}$ shall be greater than or equal to a_{urban} .

- 1.3.3.3.2. Constant speed test

For the constant speed tests the gears or gear selector positions and the test speeds shall be identical to those used in the full throttle acceleration tests previously performed.

- 1.4. Data processing and reporting

- 1.4.1. General

At least three measurements for each test condition shall be made on each side of the vehicle and for each gear.

The maximum A-weighted sound pressure level L indicated during each passage of the vehicle between AA' and BB' (see annex 4 – Figure 1) shall be mathematically rounded to the nearest first decimal place (e.g. XX.X) for both microphone positions. If a sound peak obviously out of character with the general sound pressure level is observed, that measurement shall be discarded.

The first three valid consecutive measurement results for each test condition, within 2.0 dB(A), allowing for the deletion of non-valid results, shall be used for the calculation of the appropriate intermediate or final result.

The speed measurements at AA' ($v_{AA'}$), BB' ($v_{BB'}$), and PP' ($v_{PP'}$) shall be mathematically rounded to the nearest first decimal place (e.g. XX.X) and noted for further calculations.

- 1.4.2. Calculation of the acceleration

All accelerations are calculated using different speeds of the vehicle on the test track. Depending on the type of transmission the acceleration is either calculated between the lines AA' and BB' or between the lines PP' and BB' as specified below. The method used for the calculation of the acceleration shall be indicated in the test report.

In all of the following cases the acceleration is calculated between the lines AA' and BB' as specified in paragraph 1.4.2.1. below:

- The vehicle is equipped with a manual transmission.
- The vehicle is equipped with an automatic transmission or with a transmission with continuously variable gear ratios (CVTs) but tested with locked gear ratios.
- The vehicle is equipped with a an automatic transmission, an adaptive transmission or a transmission with variable gear ratios and tested with non-locked gear ratios, and electronic or mechanical devices, including alternative gear selector positions, are used to prevent a downshift to a gear which is typically not used at the specified test condition in urban traffic.
- **The vehicle is equipped with a an automatic transmission, an adaptive transmission or a transmission with variable gear ratios and tested with non-locked gear ratios, and a stable acceleration is achieved between the lines AA' and BB', possibly by used of pre-acceleration.**

6

In all other cases the acceleration is calculated between the lines PP' and BB' as specified in paragraph 1.4.2.2. below.

1.4.2.1. Calculation of the acceleration between the lines AA' and BB'

The acceleration is calculated from measurements of the vehicle speed at the lines AA' and BB':

$$a_{\text{wot,(i),j}} = ((v_{\text{BB',j/3,6}})^2 - (v_{\text{AA',j/3,6}})^2) / (2 \times (20 + l_{\text{ref}})),$$

$$a_{\text{wot,(i),j}} = ((v_{\text{BB',j/3,6}})^2 - (v_{\text{AA',j/3,6}})^2) / (2 \times (20 + l_{\text{veh}})),$$

5

where the index “(i)” refers to the gear used and the index “j” to the number of the individual measurement. The velocities are expressed in units of km/h and the resulting accelerations have units of m/s²

where l_{ref} is either the length of vehicle or 2m, as selected by the manufacturer.

where l_{veh} is the length of vehicle.

1.4.2.2. Calculation of the acceleration between the lines PP' and BB'

The acceleration is calculated from measurements of the vehicle speed at the lines PP' and BB':

$$a_{\text{wot,(i),j}} = ((v_{\text{BB',j/3,6}})^2 - (v_{\text{PP',j/3,6}})^2) / (2 \times (10 + l_{\text{ref}})),$$

$$a_{\text{wot,(i),j}} = ((v_{\text{BB',j/3,6}})^2 - (v_{\text{PP',j/3,6}})^2) / (2 \times (10 + l_{\text{veh}})),$$

5

where the index “(i)” refers to the gear used and the index “j” to the number of the individual measurement. The velocities are expressed in units of km/h and the resulting accelerations have units of m/s^2 .

where l_{ref} is either the length of vehicle or 2m, as selected by the manufacturer.

6

where l_{veh} is the length of vehicle.

Pre-acceleration shall not be used.

1.4.2.3. Averaging of individual measurements

The calculated accelerations from three valid runs are arithmetically averaged to give the mean acceleration for the test condition;

$$a_{wot,(i)} = 1/3 \times (a_{wot,(i),1} + a_{wot,(i),2} + a_{wot,(i),3}).$$

The mean acceleration $a_{wot,(i)}$ shall be mathematically rounded to the nearest second decimal place (e.g. XX.XX) and noted for further calculations.

1.4.3. Calculation of the gear weighting factor

The gear weighting factor k is used only in the case of a two-gear test to combine the results from both gears into a single result.

The gear weighting factor is a dimensionless number defined as

$$k = (a_{wot,ref} - a_{wot,(i+1)}) / (a_{wot(i)} - a_{wot,(i+1)}).$$

1.4.4. Calculation of the partial power factor

The partial power factor k_p is a dimensionless number used to combine the results of a full throttle acceleration test with those of a constant speed test.

1.4.4.1. For vehicles tested in two gears the partial power factor is defined as

$$k_p = 1 - (a_{urban} / a_{wot,ref}).$$

1.4.4.2. For vehicles tested in a single gear or with the gear selector in one position the partial power factor is defined as

$$k_p = 1 - (a_{urban} / a_{wot,(i)}).$$

7

If $a_{wot,(i)}$ is equal to or less than a_{urban} , k_p is set to zero.

If $a_{wot,(i)}$ is equal to or less than a_{urban} , the vehicle shall be rejected.

1.4.5. Processing of the sound pressure measurements

For a given test condition, the three individual results of each side of the vehicle shall be averaged separately:

$$L_{mode,(i),side} = 1/3 \times (L_{mode,(i),side,1} + L_{mode,(i),side,2} + L_{mode,(i),side,3}),$$

where the index “mode” refers to the test mode (full throttle acceleration or constant speed), “(i)” to the gear and “side” to the microphone position (left or right).

The higher value of the two averages shall be mathematically rounded to the nearest first decimal place (e.g. XX.X) and noted for further calculations:

$$L_{\text{mode,(i)}} = \text{MAX} (L_{\text{mode,(i),left}} ; L_{\text{mode,(i),right}})$$

1.4.6. Calculation of the final test results

1.4.6.1. Vehicles with $PMR \leq 25$

Vehicles with a PMR not exceeding 25 are tested in a single gear or gear selector position only under full throttle. The final test result is the sound pressure level $L_{\text{wot,(i)}}$ mathematically rounded to the nearest integer.

1.4.6.2. Vehicles with $PMR > 25$

If the vehicle was tested in two gears the gear weighting factor is used to calculate the test results of the full throttle acceleration tests and of the constant speed tests:

$$L_{\text{wot}} = L_{\text{wot (i+1)}} + k \times (L_{\text{wot,(i)}} - L_{\text{wot,(i+1)}})$$

$$L_{\text{crs}} = L_{\text{crs (i+1)}} + k \times (L_{\text{crs,(i)}} - L_{\text{crs,(i+1)}})$$

If the vehicle was tested in a single gear or gear selector position no further weighting is necessary:

$$L_{\text{wot}} = L_{\text{wot,(i)}}$$

$$L_{\text{crs}} = L_{\text{crs,(i)}}$$

The sound pressure level L_{urban} representing urban driving is finally calculated using the partial power factor k_p :

$$L_{\text{urban}} = L_{\text{wot}} - k_p \times (L_{\text{wot}} - L_{\text{crs}})$$

All sound pressure levels are mathematically rounded to the nearest first decimal place (e.g. XX.X).

2. Noise from stationary motor cycle (measuring conditions and method for testing of the vehicle in use).

2.1. Sound-pressure level in the immediate vicinity of the motor cycle

In order to facilitate subsequent noise tests on motor cycles in use, the sound-pressure level shall also be measured in the immediate vicinity of the exhaust-system outlet in accordance with the following requirements, the result of the measurement being entered in the communication referred to in annex 1.

2.2. Measuring instruments

A precision sound-level meter as defined in paragraph 1.2.1. shall be used.

2.3. Conditions of measurement

2.3.1. Condition of the motor cycle

The vehicle transmission shall be in neutral position and the clutch engaged, or in parking position for automatic transmission, and the parking brake applied for safety, if equipped.

The vehicle air conditioner, if equipped, shall be turned off.

If the vehicle is fitted with fan(s) having an automatic actuating mechanism, this system shall not be interfered with during the sound pressure level measurements.

The engine hood or compartment cover shall be closed.

Before each series of measurements, the engine shall be brought to its normal operating temperature, as specified by the manufacturer.

In case of a two-wheeled motor-driven vehicle having no neutral gear position, measurements shall be carried out with the rear wheel raised off the ground so that the wheel can rotate freely.

If it is necessary to raise a two-wheeled vehicle off the ground to perform the test, the microphone measurement position shall be adjusted to achieve the specified distance from the reference point of the exhaust pipe; see Figure 1 for the location of the reference points.

2.3.2. Test site

A suitable test site shall be outdoors and consist of a level concrete, dense asphalt or similar hard material flat surface, free from snow, grass, loose soil, ashes or other sound-absorbing material. It shall be in an open space free from large reflecting surfaces, such as parked vehicles, buildings, billboards, trees, shrubbery, parallel walls, people, etc., within a 3 m radius from the microphone location and any point of the vehicle.

As an alternative to outside testing, a semi-anechoic chamber may be used. The semi-anechoic chamber shall fulfill the acoustical requirements given above. These requirements shall be met if the testing facility meets the 3 m distance criteria above and has a cut-off frequency below the lower of:

- one-third-octave band below the lowest fundamental frequency of the engine during test conditions; and
- 100 Hz.

Note: The noise performance of indoor testing facilities is specified in terms of the cut-off frequency (Hz). This is the frequency above which the room can be assumed to act as a semi-anechoic space.

2.3.3. Miscellaneous

Readings of the measuring instrument caused by ambient noise and wind effects shall be at least 10 dB(A) lower than the sound levels to be measured.

A suitable windshield may be fitted to the microphone provided that account is taken of its effect on the sensitivity of the microphone.

The tests shall not be carried out if the wind speed, including gusts, exceeds 5 m/s during the sound-measurement interval.

2.4. Method of measurement

2.4.1. Positioning of the microphone (see appendix B – Figure B.1)

The microphone shall be located at a distance of $0.5 \text{ m} \pm 0.01 \text{ m}$ from the reference point of the exhaust pipe defined in Figure 1 and at an angle of $45^\circ \pm 5^\circ$ to the vertical plane containing the flow axis of the pipe termination. The microphone shall be at the height of the reference point, but not less than 0.2 m from the ground surface. The reference axis of the microphone shall lie in a plane parallel to the ground surface and shall be directed towards the reference point on the exhaust outlet.

If two microphone positions are possible, the location farthest laterally from the vehicle longitudinal centreline shall be used.

If the flow axis of the exhaust outlet pipe is at $90^\circ \pm 5^\circ$ to the vehicle longitudinal centreline, the microphone shall be located at the point that is the furthest from the engine.

If a vehicle has two or more exhaust outlets spaced less than 0.3 m apart and connected to a single silencer, only one measurement shall be made. The microphone shall be located relative to the outlet the farthest from the vehicle's longitudinal centreline, or, when such outlet does not exist, to the outlet that is highest above the ground.

For vehicles having an exhaust provided with outlets spaced more than 0.3 m apart, one measurement is made for each outlet as if it were the only one, and the highest sound pressure level shall be noted.

For the purpose of roadside checking, the reference point may be moved to the outer surface of the vehicle body.

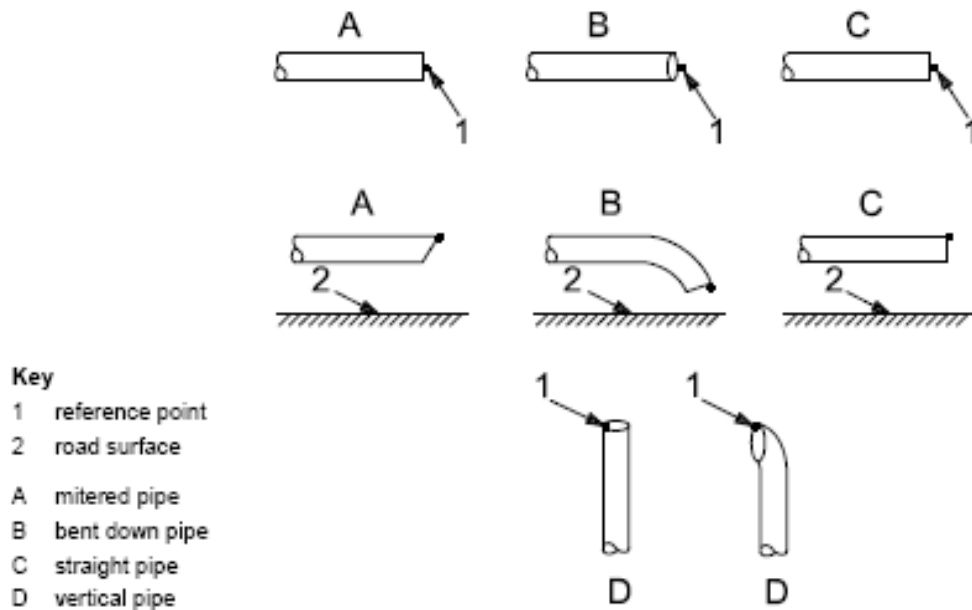

Figure 1 — Reference point

2.4.2. Operating conditions

2.4.2.1 Target engine speed

The target engine speed is defined as

75 per cent of S for vehicles with $S \leq 5,000 \text{ min}^{-1}$, and

50 per cent of S for vehicles with $S > 5,000 \text{ min}^{-1}$.

For a vehicle which cannot reach, in a stationary test, the target engine speed defined above, 95 per cent of the maximum engine speed reachable in a stationary test shall be used instead as target engine speed.

2.4.2.2. Test procedure

The engine speed shall be gradually increased from idle to the target engine speed and held constant within a tolerance band of ± 5 per cent. Then the throttle control shall be rapidly released and the engine speed shall be returned to idle. The sound pressure level shall be measured during a period consisting of constant engine speed of at least 1 s and throughout the entire deceleration period. The maximum sound level meter reading shall be taken as the test value.

A measurement shall be regarded as valid only if the test engine speed did not deviate from the target engine speed by more than the specified tolerance of ± 5 per cent for at least 1 s.

2.4.3. Multi-mode exhaust system

Vehicles equipped with a multi-mode exhaust system and a manual exhaust mode control shall be tested in all modes.

2.5. Results

- 2.5.1. The Communication referred to in annex 1 shall indicate all relevant data and particularly those used in measuring the noise of the stationary motor cycle.
- 2.5.2. Measurements shall be made at the microphone location(s) prescribed above.
- The maximum A-weighted sound pressure level indicated during the test shall be noted, retaining one significant figure behind the decimal place (e.g. 92.45 shall be noted as to 92.5 while 92.44 shall be noted as to 92.4).
- The test shall be repeated until three consecutive measurements that are within 2.0 dB(A) of each other are obtained at each outlet.
- 2.5.3. The result for a given outlet is the arithmetic average of the three valid measurements, mathematically rounded to the nearest integer value (e.g. 92.5 shall be noted as to 93 while 92.4 shall be noted as to 92).
- 2.5.4. For vehicles equipped with multiple exhaust outlets, the reported sound pressure level shall be for the outlet having the highest average sound pressure level.
- 2.5.5. For vehicles equipped with a multi-mode exhaust system and a manual exhaust mode control the reported sound pressure level shall be for the mode having the highest average sound pressure level.
3. Noise from the motor cycle in motion (data reported to facilitate testing of the vehicle in use).
- 3.1. A test procedure for in-use compliance tests may be defined by a Contracting Party, taking due account of any differences from the test conditions used at type-approval.
- 3.2. In order to facilitate in-use compliance test of motor cycles, the following information relating to the sound-pressure level measurements carried out in accordance with paragraph 1 of annex 3 for the motor cycle in motion is referred to as in-use compliance reference data:
- gear (i) or, for vehicles tested with non-locked gear ratios, the position of the gear selector chosen for the test;
 - the pre-acceleration length l_{PA} in m;
 - the average vehicle speed in km/h at the beginning of the full throttle acceleration for tests in gear (i); and
 - the sound pressure level $L_{wot,(i)}$ in dB(A) of the wide-open-throttle tests in gear (i), defined as the maximum of the two values resulting from averaging the individual measurement results at each microphone position separately.
- 3.3. The in-use compliance reference data shall be entered in the communication form conforming to annex 1.

Annex 3 – Appendix A
(informative)

Flowchart of the test procedure for the test of the vehicle in motion
for vehicles of category L3 with $PMR \leq 25$

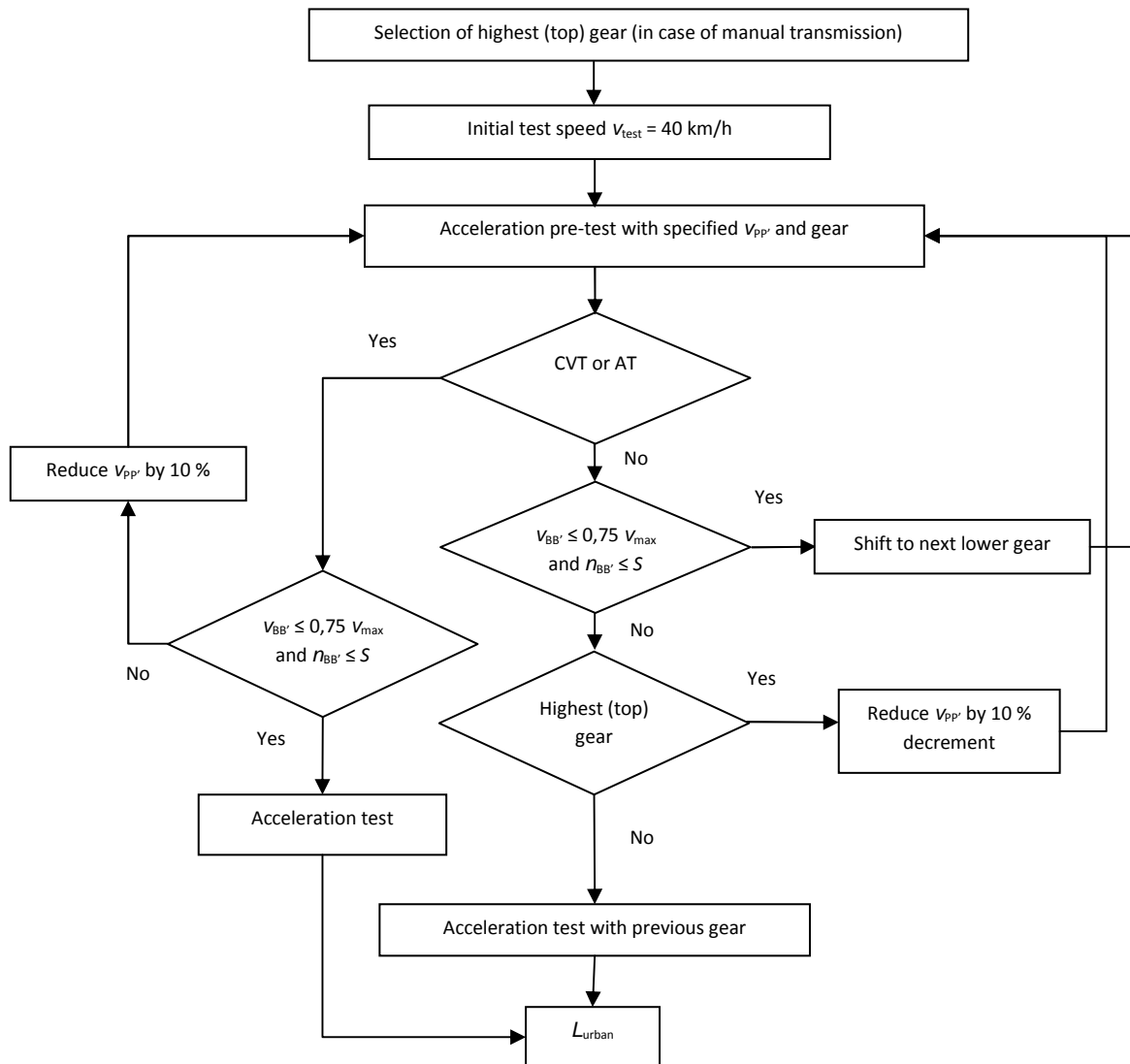

Figure A.1 - Flowchart of the test procedure for the test of the vehicle in motion for vehicles of category L3 with $PMR \leq 25$

Annex 3 – Appendix B

Positioning of the microphones for the stationary noise test

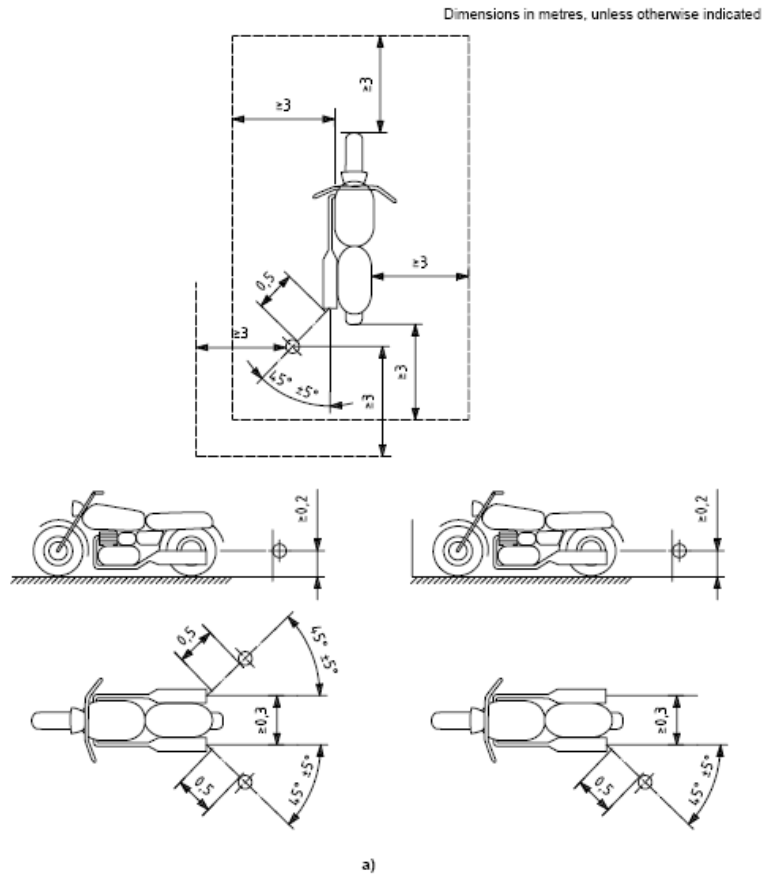

Figure B.1 - Positioning of the microphones for the stationary noise test

Annex 4

SPECIFICATIONS FOR THE TEST SITE

1. Introduction

This annex describes the specifications relating to the physical characteristics and the laying of the test track. These specifications, based on a special standard,^{1/} describe the required physical characteristics as well as the test methods for these characteristics.

2. Required characteristics of the surface

A surface is considered to conform to this standard provided that the texture and voids content or sound absorption coefficient have been measured and found to fulfil all the requirements of paragraphs 2.1. to 2.4. below and provided that the design requirements (para. 3.2.) have been met.

2.1. Residual voids content

The residual voids content, V_C , of the test track paving mixture shall not exceed 8 per cent. For the measurement procedure, see paragraph 4.1..

2.2. Sound absorption coefficient

If the surface fails to conform to the residual voids content requirement, the surface is acceptable only if its sound absorption coefficient, α , ≤ 0.10 . For the measurement procedure, see paragraph 4.2. The requirement of paragraphs 2.1. and 2.2. is met also if only sound absorption has been measured and found to be $\alpha \leq 0.10$.

Note: The most relevant characteristic is the sound absorption, although the residual voids content is more familiar among road constructors. However, sound absorption needs to be measured only if the surface fails to conform to the voids requirement. This is because the latter is connected with relatively large uncertainties in terms of both measurements and relevance and some surfaces may therefore be rejected erroneously when the voids measurement only is used as a basis.

2.3. Texture depth

The texture depth (TD) measured according to the volumetric method (see para. 4.3. below) shall be:

$$TD \geq 0.4 \text{ mm}$$

^{2/} ISO 10844:1994

2.4. Homogeneity of the surface

Every practical effort shall be taken to ensure that the surface is made to be as homogeneous as possible within the test area. This includes the texture and voids content, but it should also be observed that if the rolling process results in more effective rolling at some places than others, the texture may be different and unevenness causing bumps may also occur.

2.5. Periodic testing

In order to check whether the surface continues to conform to the texture and voids content or sound absorption requirements stipulated in this standard, periodic testing of the surface shall be done at the following intervals:

- (a) For residual voids content or sound absorption:
 - when the surface is new;
 - if the surface meets the requirements when new, no further periodical testing is required.
- (b) For texture depth (TD):
 - when the surface is new;
 - when the noise testing starts (NB: not before four weeks after laying);
 - then every 12 months.

3. Test surface design

3.1. Area

When designing the test track layout it is important to ensure that, as a minimum requirement, the area traversed by the vehicles running through the test strip is covered with the specified test material with suitable margins for safe and practical driving. This will require that the width of the track is at least 3 m and the length of the track extends beyond lines AA and BB by at least 10 m at either end. Figure 1 shows a plan of a suitable test site and indicates the minimum area which shall be machine laid and machine compacted with the specified test surface material. According to paragraph 1.5.4.1. of annex 3 measurements have to be made on each side of the vehicle. This can be made either by measuring with two microphone locations (one on each side of the track) and driving in one direction, or measuring with a microphone only on one side of the track but driving the vehicle in two directions. If the latter method is used, then there are no surface requirements on that side of the track where there is no microphone.

$d_{\max} = 10 \text{ mm}$ for the lower tolerance curve

$d_{\max} = 6.3 \text{ mm}$ for the upper tolerance curve

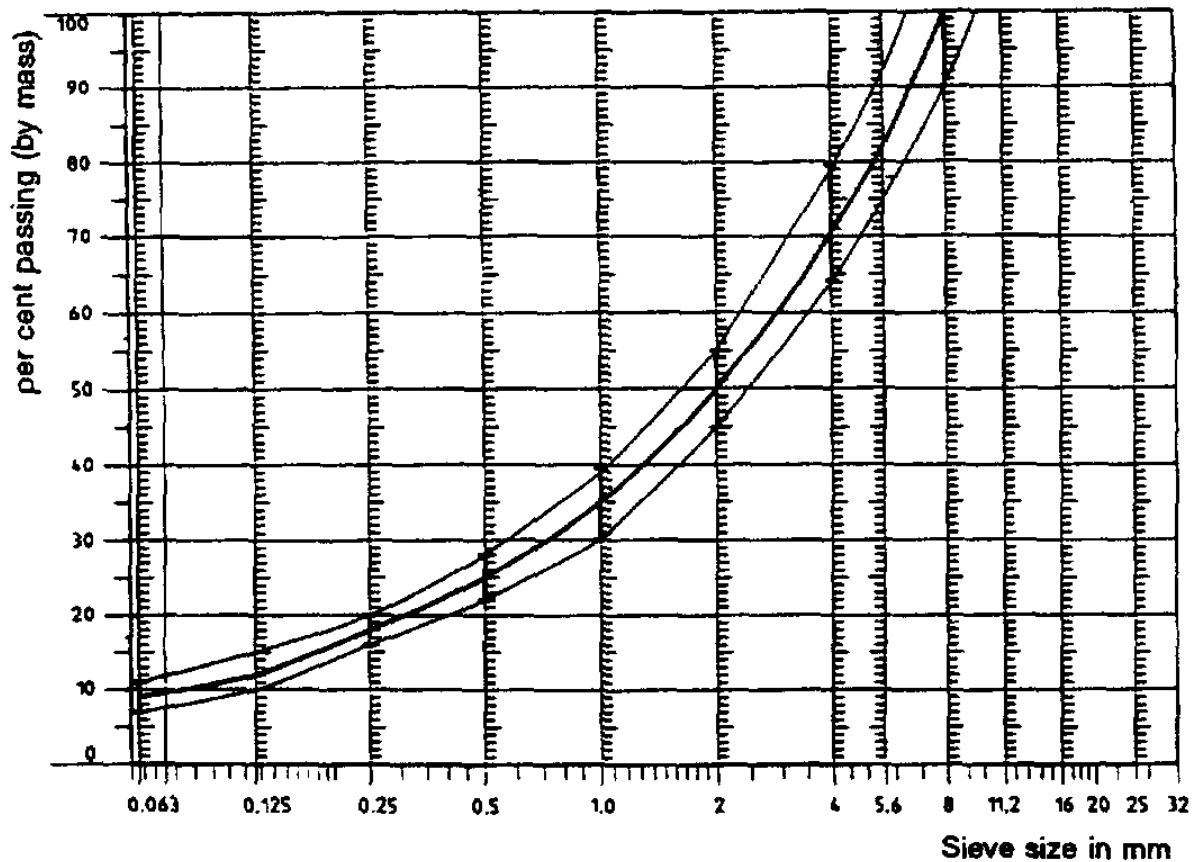

Figure 2: Grading curve of the aggregate in the asphaltic mix with tolerances

In addition to the above, the following recommendations are given:

The sand fraction ($0.063 \text{ mm} < \text{square mesh sieve size} < 2 \text{ mm}$) shall include no more than 55 per cent natural sand and at least 45 per cent crushed sand;

The base and sub-base shall ensure a good stability and evenness, according to best road construction practice;

The chippings shall be crushed (100 per cent crushed faces) and of a material with a high resistance to crushing;

The chippings used in the mix shall be washed;

No extra chippings shall be added onto the surface;

The binder hardness expressed as PEN value shall be 40-60, 60-80 or even 80-100 depending on the climatic conditions of the country. The rule is that as hard a binder as possible shall be used, provided this is consistent with common practice;

The temperature of the mix before rolling shall be chosen so as to achieve by subsequent rolling the required voids content. In order to increase the probability of satisfying the specifications of paragraphs 2.1. to 2.4. above, the compactness shall be studied not only by an appropriate choice of mixing temperature, but also by an appropriate number of passings and by the choice of compacting vehicle.

Table 1: Design guidelines

Quantity	Target values		Tolerances
	by total mass of mix	by mass of the aggregate	
Mass of stones, square mesh sieve (SM) > 2 mm	47.6 %	50.5 %	± 5
Mass of sand 0.063 < SM < 2 mm	38.0 %	40.2 %	± 5
Mass of filler SM < 0.063 mm	8.8 %	9.3%	± 2
Mass of binder (bitumen)	5.8 %	N.A.	± 0.5
Max. chipping size	8 mm		6.3 – 10
Binder hardness	(see para. 3.2.2. (f))		–
Polished stone value (PSV)	> 50		–
Compactness, relative to Marshall compactness	98 %		–

4. Test method

4.1. Measurement of the residual voids content

For the purpose of this measurement, cores have to be taken from the track in at least four different positions which are equally distributed in the test area between lines AA and BB (see Figure 1). In order to avoid inhomogeneity and unevenness in the wheel tracks, cores should not be taken in wheel tracks themselves, but close to them. Two cores (minimum) should be taken close to the wheel tracks and one core (minimum) should be taken approximately midway between the wheel tracks and each microphone location.

If there is a suspicion that the condition of homogeneity is not met (see para. 2.4.), cores shall be taken from more locations within the test area. The residual voids content has to be determined for each core, then the average value from all cores shall be calculated and compared with the requirement of paragraph 2.1. In addition, no single core shall have a voids value which is higher than 10 per cent. The test surface constructor is reminded of the problem which may arise when the test area is heated by pipes or electrical wires and cores must be taken from this area. Such installations must be carefully planned with respect to future core drilling locations. It is

recommended to leave a few locations of size approximately 200 x 300 mm where there are no wires/pipes or where the latter are located deep enough in order not to be damaged by cores taken from the surface layer.

4.2. Sound absorption coefficient

The sound absorption coefficient (normal incidence) shall be measured by the impedance tube method using the procedure specified in ISO 10534:1994 - "Acoustics - Determination of sound absorption coefficient and impedance by a tube method."

Regarding test specimens, the same requirements shall be followed as regarding the residual voids content (see para. 4.1.). The sound absorption shall be measured in the range between 400 Hz and 800 Hz and in the range between 800 Hz and 1,600 Hz (at least at the centre frequencies of third octave bands) and the maximum values shall be identified for both of these frequency ranges. Then these values, for all test cores, shall be averaged to constitute the final result.

4.3. Volumetric macro texture measurement

For the purpose of this standard, texture depth measurements shall be made on at least 10 positions evenly spaced along the wheel tracks of the test strip and the average value taken to compare with the specified minimum texture depth. For the description of the procedure see standard ISO 10844:1994.

5. Stability in time and maintenance

5.1. Age influence

In common with any other surfaces, it is expected that the tyre/road noise level measured on the test surface may increase slightly during the first 6-12 months after construction.

The surface will achieve its required characteristics not earlier than four weeks after construction.

The stability over time is determined mainly by the polishing and compaction by vehicles driving on the surface. It shall be periodically checked as stated in paragraph 2.5.

5.2. Maintenance of the surface

Loose debris or dust which could significantly reduce the effective texture depth must be removed from the surface. In countries with winter climates, salt is sometimes used for de-icing. Salt may alter the surface temporarily or even permanently in such a way as to increase noise and is therefore not recommended.

5.3. Repaving the test area

If it is necessary to repave the test track, it is usually unnecessary to repave more than the test strip (of 3 m width in Figure 1) where vehicles are driving,

provided the test area outside the strip met the requirement of residual voids content or sound absorption when it was measured.

6. Documentation of the test surface and of tests performed on it

6.1. Documentation of the test surface

The following data shall be given in a document describing the test surface:

- 6.1.1. The location of the test track.
- 6.1.2. Type of binder, binder hardness, type of aggregate, maximum theoretical density of the concrete (D_R), thickness of the wearing course and grading curve determined from cores from the test track.
- 6.1.3. Method of compaction (e.g. type of roller, roller mass, number of passes).
- 6.1.4. Temperature of the mix, temperature of the ambient air and wind speed during laying of the surface.
- 6.1.5. Date when the surface was laid and contractor.
- 6.1.6. All or at least the latest test results, including:
 - 6.1.6.1. The residual voids content of each core.
 - 6.1.6.2. The locations in the test area from where the cores for voids measurements have been taken.
 - 6.1.6.3. The sound absorption coefficient of each core (if measured). Specify the results both for each core and each frequency range as well as the overall average.
 - 6.1.6.4. The locations in the test area from where the cores for absorption measurement have been taken.
 - 6.1.6.5. Texture depth, including the number of tests and standard deviation.
 - 6.1.6.6. The institution responsible for the tests according to paragraphs 6.1.6.1. and 6.1.6.2. and the type of equipment used.
 - 6.1.6.7. Date of the test(s) and date when the cores were taken from the test track.

6.2. Documentation of vehicle noise tests conducted on the surface

In the document describing the vehicle noise test(s) it shall be stated whether all the requirements of this standard were fulfilled or not. Reference shall be given to a document according to paragraph 6.1. describing the results which verify this.

Annex 5

EXHAUST OR SILENCING SYSTEMS CONTAINING FIBROUS MATERIAL

1. Fibrous absorbent material must be asbestos-free and may be used in the construction of the exhaust or silencing system only if suitable devices ensure that the fibrous material is kept in place for the whole time that the exhaust or silencing system is being used and the exhaust or silencing system meets the requirements of any one of paragraphs 1.1., 1.2. and 1.3.:
- 1.1. After removal of the fibrous material, the sound level must comply with the requirements of paragraph 6 of this Regulation.
- 1.2. The fibrous absorbent material may not be placed in those parts of the silencer through which the exhaust gases pass and must comply with the following requirements:
 - 1.2.1. The material must be heated at a temperature of $650 \pm 5^{\circ}\text{C}$ for four hours in a furnace without reduction in every length, diameter or bulk density of the fibre.
 - 1.2.2. After heating at $650 \pm 5^{\circ}\text{C}$ for one hour in a furnace, at least 98 per cent of the material must be retained in a sieve of nominal aperture size $250 \mu\text{m}$ complying with ISO Standard 3310/1:1990 when tested in accordance with ISO Standard 2559:2000.
 - 1.2.3. The loss in weight of the material must not exceed 10.5 per cent after soaking for 24 hours at $90 \pm 5^{\circ}\text{C}$ in a synthetic condensate of the following composition:
 - 1 N hydrobromic acid (HBr): 10 ml
 - 1 N sulphuric acid (H_2SO_4): 10 ml
 - Distilled water to make up to 1,000 ml.
- Note: The material must be washed in distilled water and dried for one hour at 105°C before weighing.
- 1.3. Before the system is tested in accordance with annex 3, it must be put into a normal state for road use by one of the following condition methods:
 - 1.3.1. **CONDITIONING BY CONTINUOUS ROAD OPERATION**
 - 1.3.1.1. According to the classes of motor cycles, the minimum distances to be completed during conditioning are:

Class of motor cycle according to Power-to-mass ratio index (<i>PMR</i>)	Distance (km)
Class I ≤ 25	4,000
Class II $> 25 \leq 50$	6,000
Class III > 50	8,000

- 1.3.1.2. 50 ± 10 per cent of this conditioning cycle consists of town driving and the remainder of long-distance runs at high speed; the continuous road cycle may be replaced by a corresponding test-track programme.
- 1.3.1.3. The two speed regimes must be alternated at least six times.
- 1.3.1.4. The complete test programme must include a minimum of 10 breaks of at least three hours' duration in order to reproduce the effects of cooling and condensation.
- 1.3.2. **CONDITIONING BY PULSATION**
- 1.3.2.1. The exhaust system or components thereof must be fitted to the motor cycle or to the engine. In the former case, the motor cycle must be mounted on a test bench.
- The test apparatus, a detailed diagram of which is shown in Figure 1, is fitted at the outlet of the exhaust system. Any other apparatus providing equivalent results is acceptable.
- 1.3.2.2. The test equipment must be adjusted so that the flow of exhaust gases is alternatively interrupted and restored 2,500 times by a rapid-action valve.
- 1.3.2.3. The valve must open when the exhaust gas back-pressure, measured at least 100 mm downstream of the intake flange, reaches a value of between 0.35 and 0.40 bar. Should such a figure be unattainable because of the engine characteristics, the valve must open when the gas back-pressure reaches a level equivalent to 90 per cent of the maximum that can be measured before the engine stops. It must close when this pressure does not differ by more than 10 per cent from its stabilized value with the valve open.
- 1.3.2.4. The time-delay switch must be set for the duration of exhaust gases calculated on the basis of the requirements of paragraph 1.3.2.3.
- 1.3.2.5. Engine speed must be 75 per cent of the rated engine speed (*S*).
- 1.3.2.6. The power indicated by the dynamometer must be 50 per cent of the full-throttle power measured at 75 per cent of the rated engine speed (*S*).
- 1.3.2.7. Any drainage holes must be closed off during the test.
- 1.3.2.8. The entire test must be complete within 48 hours. If necessary, a cooling period must be allowed after each hour.

1.3.3. CONDITIONING ON A TEST BENCH

1.3.3.1. The exhaust system must be fitted to an engine representative of the type fitted to the motor cycle for which the exhaust system was designed, and mounted on a test bench.

1.3.3.2. Conditioning consists of the specific number of test bench cycles for each class of motor cycle for which the exhaust system was designed. The number of cycles for each class of motor cycle is:

Class of motor cycle according to Power-to-mass ratio index (<i>PMR</i>)	Number of cycles
Class I ≤ 25	6
Class II $> 25 \leq 50$	9
Class III > 50	12

1.3.3.3. Each test-bench cycle must be followed by a break of at least six hours in order to reproduce the effects of cooling and condensation.

1.3.3.4. Each test-bench cycle consists of six phases. The engine conditions for and the duration of each phase are:

Phase	Conditions	Duration of phase in minutes	
		<i>PMR</i> ≤ 50	<i>PMR</i> > 50
1	Idling	6	6
2	25 % load at 75 % S	40	50
3	50 % load at 75 % S	40	50
4	100 % load at 75 % S	30	10
5	50 % load at 100 % S	12	12
6	25 % load at 100 % S	22	22
	Total time	2.5 hours	2.5 hours

1.3.3.5. During this conditioning procedure, at the request of the manufacturer, the engine and the silencer may be cooled in order that the temperature recorded at a point not more than 100 mm from the exhaust gas outlet does not exceed that measured when the motor cycle is running at 110 km/h or 75 per cent of *S* in top gear. The engine and/or motor cycle speeds are determined to within ± 3 per cent.

E/ECE/324
E/ECE/TRANS/505 } Rev.1/Add.40/Rev.1
Regulation No. 41
Annex 5
page 28

Figure 1
TEST APPARATUS FOR CONDITIONING BY PULSATION

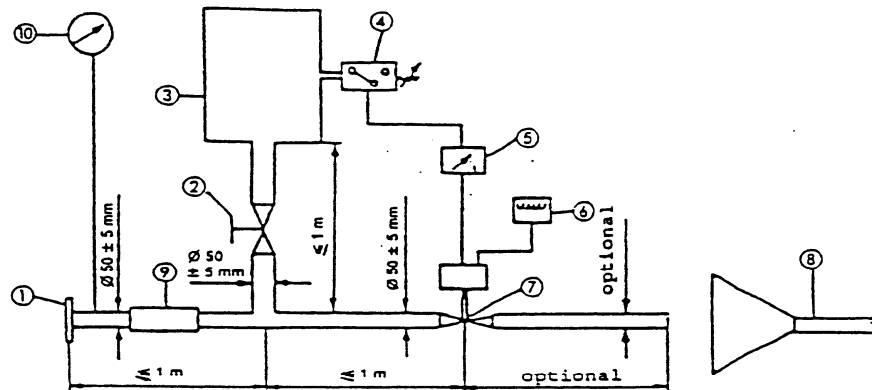

1. Inlet flange or sleeve for connection to the rear of the test exhaust system.
2. Hand-operated regulating valve.
3. Compensating reservoir with a maximum capacity of 40 litres.
4. Pressure switch with an operating range of 0.05 to 2.5 bar.
5. Time delay switch.
6. Impulse counter.
7. Quick response valve, such as exhaust brake valve 60 mm in diameter, operated by a pneumatic cylinder with an output of 120 N at 4 bar. The response time, both when opening and closing, must not exceed 0.5 seconds.
8. Exhaust gas evacuation.
9. Flexible pipe.
10. Pressure gauge.

Annex 6

MAXIMUM LIMITS OF SOUND LEVEL

Category	Power-to-mass ratio index (<i>PMR</i>)	Limit value for L_{urban} in dB(A)	Limit value for L_{wot} in dB(A)
First category	$PMR \leq 25$	□	–
Second category	$25 < PMR \leq 50$	□	–
Third category	$PMR > 50$	□	□

Annex 7

ADDITIONAL SOUND EMISSION PROVISIONS (ASEP)

1. Scope

1.1. This annex applies to vehicles of category L3 with $PMR > 50$.

1.2. Vehicles with variable gear ratios or automatic transmission with non-lockable gear ratios are exempted from the requirements of this annex, if the vehicle manufacturer provides technical documents to the type approval authority showing, that the vehicle's engine speed at BB' does neither exceed $n_{BB'} + 0.05 \times (S - n_{idle})$ nor fall below $n_{BB'} - 0.05 \times (S - n_{idle})$ for any test condition inside the ASEP control range defined in 2.5. below, where $n_{BB'}$ is the average engine speed at BB' from the three valid acceleration tests according to section 1 of annex 3.

2. Additional sound emission requirements

2.1. Measuring instruments

The requirements for the measurement equipment are identical to those defined in section 1.1. of annex 3 for the tests of the motor cycle in motion.



Some motor cycles may have different software programs or modes which affect the acceleration behavior of the vehicle. If the vehicle has different modes leading to valid accelerations, all these modes shall be in compliance with the requirements in this annex.

2.2. Acoustical environment, meteorological conditions and background noise

The requirements concerning the acoustical environment, the meteorological conditions and the background noise are identical to those defined in section 1.2. of annex 3 for the tests of the motor cycle in motion.

2.3. Microphone positions and conditions of the vehicle

The requirements concerning the microphone positions and the conditions of the vehicle are identical to those defined in sections 1.3.1. and 1.3.2. of annex 3 for the tests of the motor cycle in motion.

2.4. General operating conditions

The general operating conditions are identical to those defined in section 1.3.3.1. of annex 3 for the tests of the motor cycle in motion.

2.5. ASEP control range

The requirements of this annex apply to any vehicle operation with the following restrictions:

- $v_{AA'}$ shall be at least 20 km/h.
- $v_{BB'}$ shall not exceed 80 km/h.
- $n_{AA'}$ shall be at least $0.1 \times (S - n_{idle}) + n_{idle}$.

4

- $n_{BB'}$ shall not exceed

$0.85 \times (S - n_{idle}) + n_{idle}$	for $PMR \leq 66$ and
$3.4 \times PMR^{-0.33} \times (S - n_{idle}) + n_{idle}$	for $PMR > 66$.
$3.4105 \times PMR^{-0.3315} \times (S - n_{idle}) + n_{idle}$	for $PMR > 66$.

2.6. ASEP limits

The maximum noise level recorded during the passage of the motorcycle through the test track shall not exceed

8

$$L_{wot,(i)} + [1.3] \times (n_{PP'} - n_{wot,(i)})/1000 + [2] \quad \text{for } n_{PP'} < n_{wot,(i)} \text{ and}$$

$$L_{wot,(i)} + [4.8] \times (n_{PP'} - n_{wot,(i)})/1000 + [2] \quad \text{for } n_{PP'} \geq n_{wot,(i)},$$

where $L_{wot,(i)}$ has the same meaning as in section 1 of annex 3 and $n_{wot,(i)}$ refers to the corresponding engine speed when the front of the vehicle passes the line PP'.

9

$$L_{wot,(i)} + [2] \times (n_{max'} - n_{wot,(i)})/1000 + [x] \quad \text{for } n_{max'} < n_{wot,(i)} \text{ and}$$

$$L_{wot,(i)} + [4] \times (n_{max'} - n_{wot,(i)})/1000 + [x] \quad \text{for } n_{max'} \geq n_{wot,(i)},$$

where $L_{wot,(i)}$ has the same meaning as in section 1 of annex 3 and $n_{wot,(i)}$ refers to the corresponding engine speed when the maximum sound level is recorded.

Note: When compliance with these limits is checked, values for $L_{wot,(i)}$ and $n_{wot,(i)}$ shall not be taken from type approval documents but newly determined by measurements as defined in section 1 of annex 3, however using the same gear (i) and the same pre-acceleration distance as during type approval.

3. Testing compliance by measurements

3.1. General

10

The type approval authority as well as the technical service may request tests to check the compliance of the motorcycle with the requirements of section 2 above. To avoid undue work load testing is restricted to the reference points defined in paragraph 3.2. below and **one up to three** additional operating conditions other than the reference points but inside the ASEP control range.

3.2. ASEP reference test conditions

3.2.1. Test procedure

When the front of the vehicle reaches AA', the throttle shall be fully engaged and held fully engaged until the rear of the vehicle reaches BB'. The throttle must then be returned as quickly as possible to the idle position. Pre-acceleration may be used if acceleration is delayed beyond AA'. The location of the start of the acceleration shall be reported.

3.2.2. Test speed and gear selection

The vehicle shall be tested at each of the following operating conditions:

I.) $v_{AA'} = 20 \text{ km/h}$

or

$n_{AA'} = 0.1 \times (S - n_{idle}) + n_{idle}$, if the corresponding $v_{AA'} > 20 \text{ km/h}$

The selected gear shall be 4th. If stable driving cannot be achieved using 4th gear, 3rd gear shall be chosen. If stable driving cannot be achieved using 3rd gear, 2nd gear shall be chosen.

$n_{AA'}$ shall be at least $0.1 \times (S - n_{idle}) + n_{idle}$

II.) $v_{PP'} = 50 \text{ km/h}$

The selected gear (i) and pre-acceleration condition shall be the same as those used in the original type approval test of annex 3 of this Regulation.

III.) $v_{BB'}$ corresponding to

$n_{BB'} = 0.85 \times (S - n_{idle}) + n_{idle}$ for $PMR \leq 66$; and

$n_{BB'} = 3.4105 \times PMR^{-0.3315} \times (S - n_{idle}) + n_{idle}$ for $PMR > 66$

$n_{BB'} = 3.4 \times PMR^{-0.33} \times (S - n_{idle}) + n_{idle}$ for $PMR > 66$

$v_{BB'}$ shall not exceed 80 km/h

The selected gear shall be 2nd. If the 3rd gear satisfies requirements of $n_{BB'}$ and $v_{BB'}$, 3rd shall be used. If the 4th gear satisfies requirements of $n_{BB'}$ and $v_{BB'}$, 4th shall be used.

4

3.2.3. Data processing and reporting

The requirements of section 1.4. of annex 3 shall be applied.

In addition the engine speed measurements at AA', BB', and PP' in units of min^{-1} shall be mathematically rounded to the nearest integer for further calculations. For a given test condition the three individual engine speeds shall be averaged arithmetically.

The final sound pressure levels for the full throttle acceleration shall not exceed the limits specified in section 2.6. above.

Appendix 1 to Annex 7

(Maximum format: A4 (210 x 297 mm))

Statement of compliance with the Additional Sound Emission Provisions

.....(Name of manufacturer) attests that vehicles of this type
.....(type with regard to its noise emission pursuant to ECE R41)
comply with the requirements of paragraph 6.3 of ECE R41

..... (Name of manufacturer) makes this statement in good faith, after
having performed an appropriate evaluation of the sound emission performance of
the vehicles.

Date:

Name of authorized representative.....

Signature of authorized representative:.....