

Informal document GRPE-78-29  
78<sup>th</sup> GRPE, 8-11 January 2019  
Agenda item 12

**Status Report of the  
VIAQ (Vehicle Interior Air Quality)  
Informal Working Group**

GENEVA, January 9th 2019

Chair: Andrey KOZLOV, Russian Federation

Co-Chair: Jongsoon LIM, The Republic of Korea

Secretary: Mark POLSTER, Ford

During 173<sup>rd</sup> WP.29 session in Geneva (14-17 November 2017) Proposal for a new Mutual Resolution (M.R.3) for of the 1958 and the 1998 Agreements concerning Vehicle Interior Air Quality (VIAQ) was adopted (ECE/TRANS/WP.29/2017/136). Final text of Mutual Resolution M.R.3 was published at UNECE site on 1 of November 2018 as the document **ECE/TRANS/WP.29/1143**

United Nations



**Economic and Social Council**

**ECE**/TRANS/WP.29/1143

Distr.: General  
1 November 2018

Original: English

---

**Economic Commission for Europe**

**Inland Transport Committee**

**World Forum for Harmonization of Vehicle Regulations**

**Mutual Resolution No. 3 (M.R.3) of the 1958 and the 1998 Agreements**

**Concerning Vehicle Interior Air Quality (VIAQ)**

The text reproduced below was adopted on 14 November 2017 by the World Forum for Harmonization of Vehicle Regulations (WP.29) regarding the Agreement Concerning the Adoption of Uniform Technical Prescriptions for Wheeled Vehicles, Equipment and Parts which can be fitted and/or be used on Wheeled Vehicles and the Conditions for Reciprocal Recognition of Approvals Granted on the Basis of these Prescriptions (1958 Agreement) and on 15 November 2017 by the Executive Committee AC.3 of the Agreement Concerning the Establishing of Global Technical Regulations for Wheeled Vehicles, Equipment and Parts which can be fitted and/or be used on Wheeled Vehicles (1998 Agreement) (ECE/TRANS/WP.29/1118, paras. 99-100 and 101). It is based on document ECE/TRANS/WP.29/2017/136.

## ● Terms of reference

- ✓ Identify and collect the information and research data on interior air quality and its relevance for vehicles, taking into account the activities being carried out by various governments, and non-governmental organizations.
- ✓ Identify and understand the current regulatory requirements with respect to vehicle interior air quality in different markets.
- ✓ Identify, review and assess existing test procedures suitable for the measurement of harmful substance into the vehicle cabin (including test modes, sample collection methods and analysis methods, etc.)
- ✓ Develop provisions and test procedures in a recommendation by including Part 3 in the Mutual Resolution No. 3.

## ● Timeline

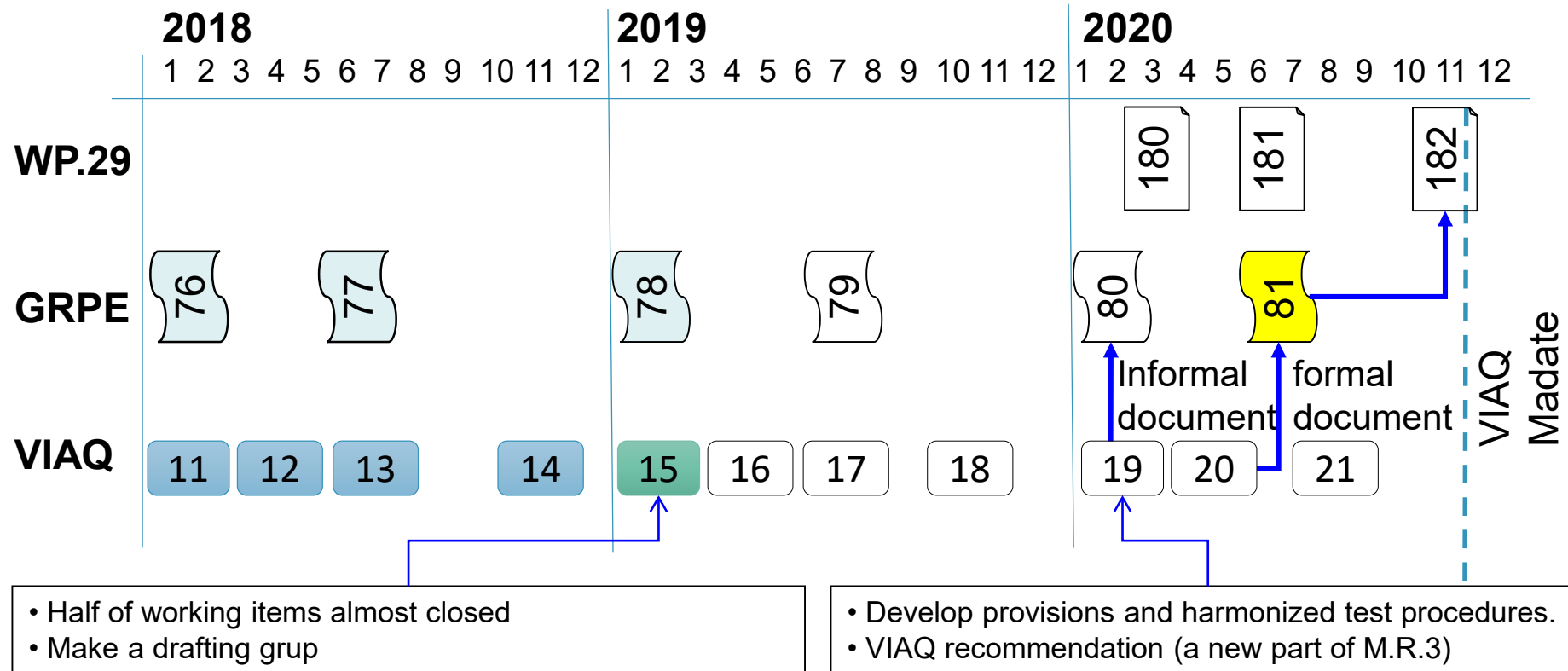

- **January 2020:** Submit the draft document to GRPE
- **June 2020:** Adoption of the draft document by GRPE
- **November 2020:** Adoption of the draft document by WP.29

## ➤ **14th VIAQ IWG Meeting**

- Moscow, Russian Federation, November 7-8<sup>th</sup> 2018
- Two days

## ➤ **15th VIAQ IWG Meeting**

- Geneva, Switzerland, January 9<sup>th</sup> 2019
- Half a day

**1. Vehicle Category**

**2. Test Vehicle age/milage**

**3. Substances to be Measured**

**4. Meteorological Conditions**

**5. General Test Conditions**

**6. Test Modes**

**7. HVAC Modes**

**8. Test Procedure**

**9. Measurement Methods**

**10. Sampling Points**

**11. Sampling Method**

**12. Test Protocol**

## 1. Vehicle Category

Agreed Item

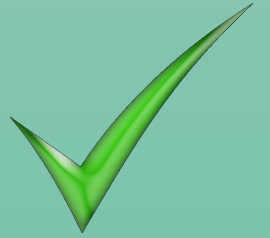

# Category 1-1



## 2. Test Vehicle age/millage

Agreed Item

New cars from series production  
Millage  
3 000 -15 000 km

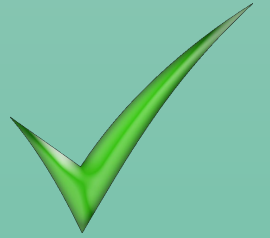



## 3. Substances to be Measured

### Russian Standard

Formaldehyde CH<sub>2</sub>O  
Nitrogen dioxide NO<sub>2</sub>  
Nitrogen oxide NO  
Carbon monoxide CO  
Saturated hydrocarbons (C<sub>2</sub>H<sub>6</sub>...C<sub>7</sub>H<sub>16</sub>)  
Methane CH<sub>4</sub>

### Agreed substances

Carbon monoxide CO  
Nitrogen oxide NO  
Nitrogen dioxide NO<sub>2</sub>  
Formaldehyde CH<sub>2</sub>O



### Korea

Carbon monoxide CO  
Nitrogen oxide NO  
Nitrogen dioxide NO<sub>2</sub>

For discussion  
(see VIAQ-13-04 and VIAQ-14-04)

Particulate matter (PM)

## 4. Meteorological Conditions

Agreed Item

- ✓ ambient air temperature:  
from  $-7^{\circ}\text{C}$  to  $+30^{\circ}\text{C}$
- ✓ relative humidity:  
from 30% to 90%
- ✓ atmospheric pressure  
from 84.0 to 108.7 kPa

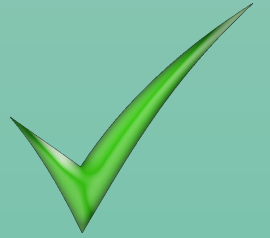

## 5. General Test Conditions

Agreed Item

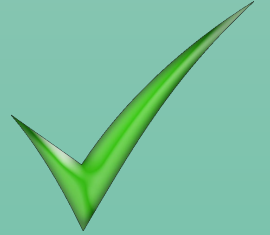

1. Test road: straight road with the slope up to 6.0%.
2. No other vehicles with engine running or other sources of air pollution are permitted in the testing zone.
3. General inspection should be checked before testing.
4. Windows, doors and ventilation hatches should be closed.
5. HVAC outside flaps have to be closed.
6. A/C should be turned off.



## 9. Measurement Methods

Substances	Proposed measuring methods	Type of analysis
CH <sub>2</sub> O	1) High performance liquid chromatography (HPLC) UV detection	1) Stationary analysis at the laboratory after preliminary air sampling to the cartridges
	2) Gas chromatography (GC) with nitrogen phosphorus detection (NPD), or mass spectrometer (MS) and capillary or packed columns	2) Stationary analysis at the laboratory after preliminary air sampling to the cartridges
	3) Photo-electric colorimetric method	3) On-line (express) analysis
NO, NO <sub>2</sub>	1) Chemiluminescence (CLD)	1) On-line (express) analysis or stationary analysis at the laboratory after preliminary air sampling to the sealed bags
	2) High-sensitivity electrochemical detection (ECD)	2) On-line (express) analysis
CO	1) Infrared photoacoustic spectroscopy	1) On-line (express) analysis
	2) Electrochemical detection (ECD)	2) On-line (express) analysis
PM <sub>2,5</sub> PM <sub>10</sub>	1) Light-scattering laser photometer need additional discussion	1) On-line (express) analysis

## 10. Sampling Points

Agreed Item

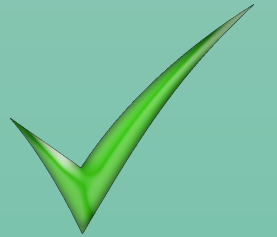
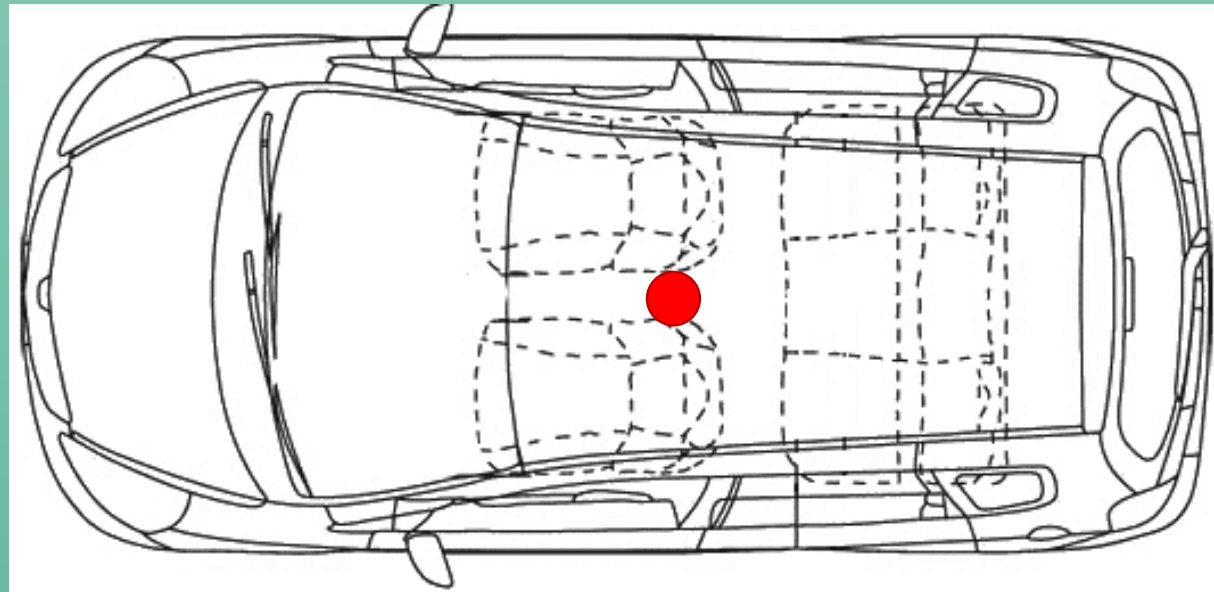

The point between headrests of front seats

## Test Modes Discussion

### 1. Idling Test

### 2. Constant Speed Test

- ✓ Movement at constant speed 50 km/h
- ✓ Movement at constant speed 90 km/h
- ✓ Movement at constant speed 130 km/h

### 3. Acceleration Test

- ✓ Acceleration from a speed of 60 km/h at wide opened throttle to 130 km/h and deceleration at closed throttle to 60 km/h repeated by 8 times



## Discussion of Idle Test Conditions and Facility (Russian Federation proposals)

Open area without any other sources of pollution

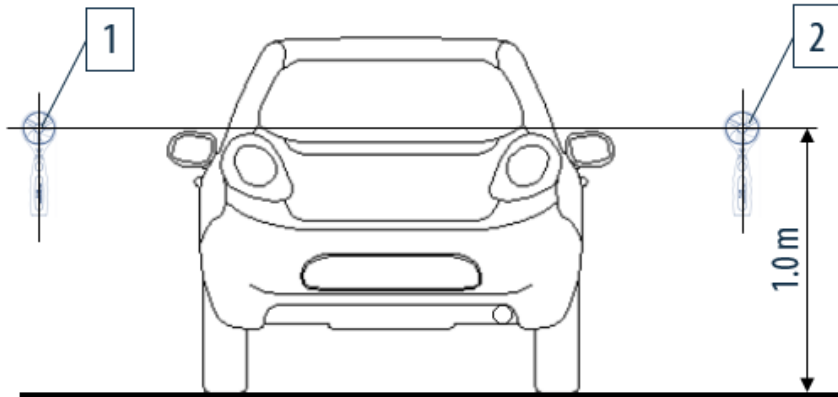

1,2 – anemometers; 3 - weather vane

### Test conditions:

- ✓ wind velocity **1.0...3.0 m/s**
- ✓ velocity difference between anemometers 1 and 2 not more than **0.2 m/s**
- ✓ wind direction deviation not more than **15 deg.**

**HVAC mode:** Recirculation **ON**; Ventilator speed - **MAXIMAL**

It is acceptable to use air blower to simulate air movement around tested vehicle

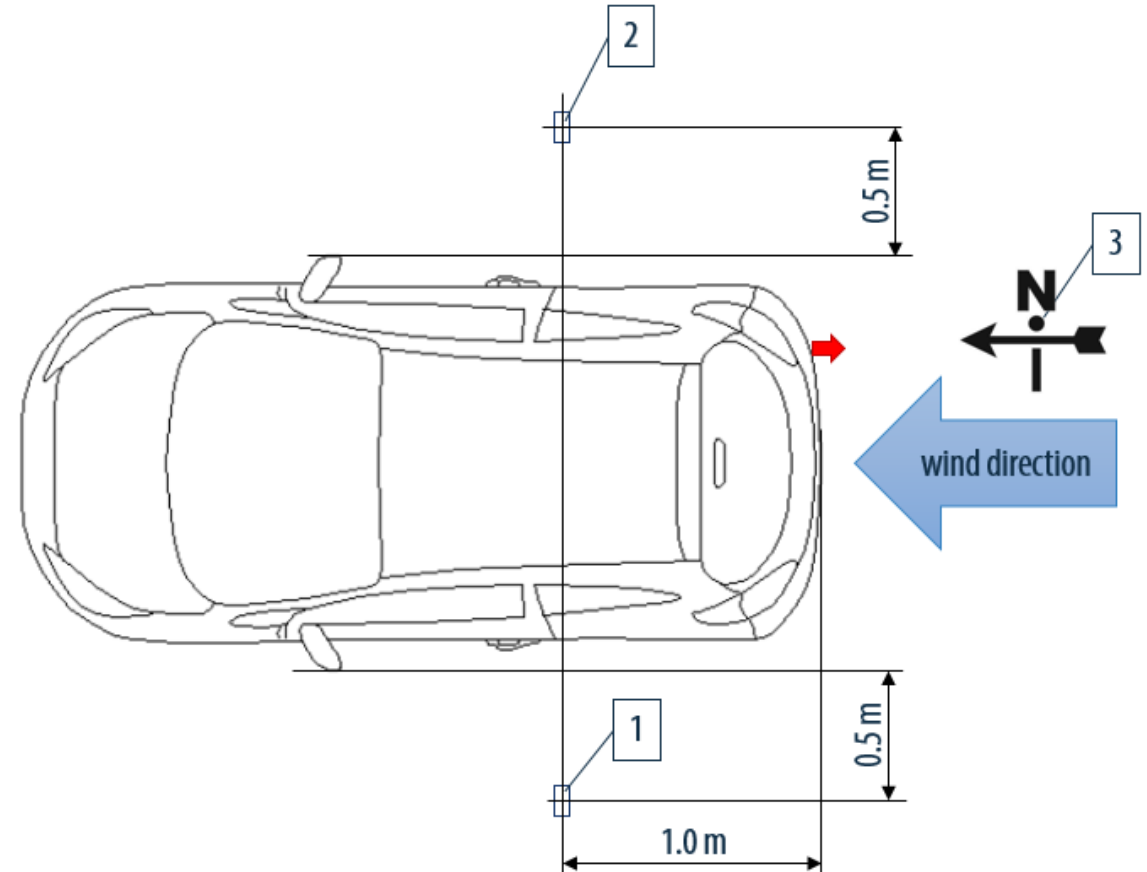



## Discussion of Idle Test Conditions and Facility (OICA proposals)



### MEASUREMENT SETTING, ENVIRONMENTAL CONDITIONS.

#### Test location:

- large fan(s), wind tight area

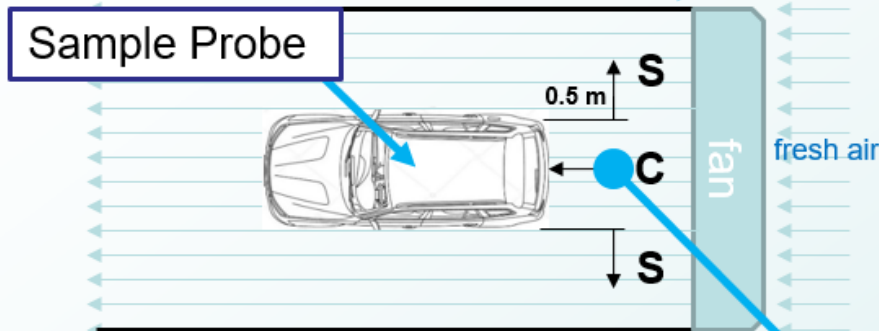

Side Walls to limit cross wind

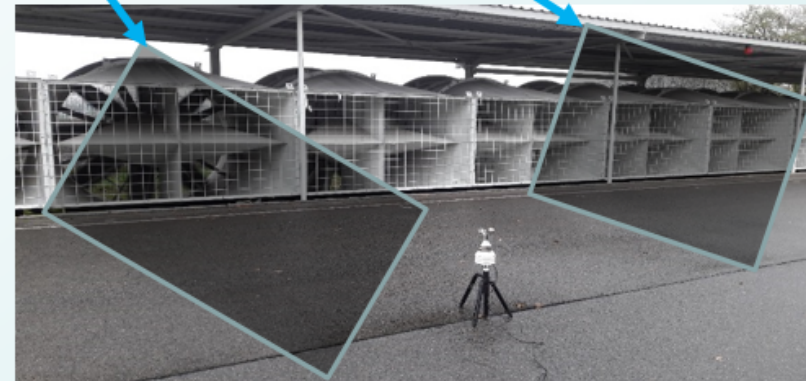

Constantly monitor Center location, 0.5 m

- Temperature: 5° C to 25° C
- Wind speed: 3.5 m/s +/- 0.5 m/s, direction is perpendicular rear vehicle
- Relative humidity: 30 % to 90 %
- Atmospheric pressure: 85 to 110 hPa
- Verify uniformity of wind at two side points, 0.5 m from each side of vehicle

➤ **16<sup>th</sup> VIAQ IWG Meeting (TBD)**

- 10-12 April or 13-17 May 2019 (Paris)
- Two days

➤ **17<sup>th</sup> VIAQ IWG Meeting (TBD)**

- 15-25 October 2019 (Munich)
- Two days