

**Economic and Social Council**

Distr.: General  
3 March 2011

Original: English  
English and French only

---

**Economic Commission for Europe**

Inland Transport Committee

**World Forum for Harmonization of Vehicle Regulations**

Working Party on Passive Safety

**Forty-ninth session**

Geneva, 16–20 May 2011

Item 19 of the provisional agenda

**Draft Regulation on pedestrian safety****Proposal for the 01 series amendments to draft Regulation on pedestrian safety****Submitted by the expert from Japan\***

The text reproduced below was prepared by the expert from Japan to propose the use of the Flexible Pedestrian Legform Impactor (Lower legform II) in the draft regulation on pedestrian safety (ECE/TRANS/WP.29/2010/127). It is based on a document without symbol (GRSP-48-09-Rev.1) distributed during the forty-eighth session of the Working Party on Passive Safety (GRSP). The modifications to the current text of ECE/TRANS/WP.29/2010/127 are marked in bold for new or strikethrough for deleted characters.

---

\* In accordance with the programme of work of the Inland Transport Committee for 2010–2014 (ECE/TRANS/208, para. 106 and ECE/TRANS/2010/8, programme activity 02.4), the World Forum will develop, harmonize and update Regulations in order to enhance the performance of vehicles. The present document is submitted in conformity with that mandate.

## I. Proposal

*Insert a new paragraph 2.41. , to read:*

"2.41. "Lower legform II"<sup>2</sup> means the flexible pedestrian lower legform impactor."

*Paragraph 4.4.1., the reference to footnote<sup>2</sup> and footnote<sup>2</sup> renumber as footnote<sup>3</sup>*

*Paragraph 5.1.1., amend to read:*

"5.1.1. Lower legform II ~~Lower legform~~ to bumper

**When tested in accordance with Annex 5, paragraph 1 (Lower legform II to bumper test procedure), the maximum dynamic medial collateral ligament elongation at the knee shall not exceed 22 mm, and the dynamic bending moments at the tibia shall not exceed 340 Nm. The maximum dynamic anterior cruciate ligament and posterior cruciate ligament elongation shall not exceed 13 mm.**

**In addition, the manufacturer may nominate bumper test widths up to a maximum of 264 mm in total where the tibia bending moment of the Lower legform II shall not exceed 380 Nm. A contracting party may restrict application of the relaxation zone requirement in its domestic legislation if it decides that such restriction is appropriate.**

**The Lower legform II shall be certified pursuant to Annex 6, paragraph 1.<sup>4</sup>**

~~When tested in accordance with Annex 5, paragraph 1. (lower legform to bumper), the maximum dynamic knee bending angle shall not exceed 19°, the maximum dynamic knee shearing displacement shall not exceed 6.0 mm, and the acceleration measured at the upper end of the tibia shall not exceed 170 g. In addition, the manufacturer may nominate bumper test widths up to a maximum of 264 mm in total where the acceleration measured at the upper end of the tibia shall not exceed 250 g.~~

~~The lower legform impactor shall be certified pursuant to Annex 6, paragraph 1. "~~

*Insert new paragraphs 11. to 11.6., to read:*

### "[11. TRANSITIONAL PROVISIONS

11.1. As from the official date of entry into force of the 01 series of amendments to this Regulation, no Contracting Party applying this Regulation shall refuse to grant approval under this Regulation as amended by the 01 series of amendments.

---

<sup>2</sup> It is the lower legform developed by the Japan Automobile Research Institute (JARI).

<sup>4</sup> [The technical specifications and detailed drawings of Lower legform II, corresponding to the principal dimension corresponding to the 50th percentile male of the United States of America, and the technical specifications for its adjustment for this test are deposited with the Secretary General of the United Nations and may be consulted on request at the secretariat of the UNECE, Palais de Nations, Geneva, Switzerland.]

- 11.2 As from [84] months after the date of entry into force, Contracting Parties applying this Regulation shall grant approvals only if the vehicle type to be approved meets the requirements of this Regulation as amended by the 01 series of amendments.
- 11.3 Contracting Parties applying this Regulation shall not refuse to grant extensions of approval to the original version of this Regulation.
- 11.4 Contracting Parties applying this Regulation shall continue to grant approvals to those types of vehicles which comply with the requirements of this Regulation in its original version during the [84] months' period which follows the date of entry into force of the 01 series of amendments.
- 11.5 No Contracting Party applying this Regulation shall refuse national or regional type approval of a vehicle type approved to the 01 series of amendments to this Regulation.
- 11.6 Even after the entry into force of the 01 series of amendments to this Regulation, approvals of the vehicles to the original version of this Regulation shall remain valid and Contracting Parties applying this Regulation shall continue to accept them.]"

*Annex 4*

*Paragraph 1, amend to read:*

- "1. Lower legform II ~~Lower legform impactor~~"

*Insert new paragraphs 1.1. to 2.4., to read:*

- "1.1. The Lower legform II shall consist of flesh, flexible long bone segments (representing femur and tibia), and a knee joint as shown in Figure 1.
- The overall length of the impactor shall be  $928 \pm 3$  mm, having a required mass of  $13.2 \pm 0.7$  kg including flesh. The length of the femur, knee joint, and tibia shall be  $339 \pm 2$  mm,  $185 \pm 1$  mm, and  $404 \pm 2$  mm respectively. The knee joint centre position shall be  $94 \pm 1$  mm from the top of the knee joint.
- Brackets, pulleys, protectors, connection parts, etc. attached to the impactor for the purpose of launching and/or protecting may extend beyond the dimensions shown in Figure 1 and Figure 2.
- 1.2. The cross-sectional shape perpendicular to the Z-axis of the femur and tibia main bodies shall be  $90 \pm 2$  mm in width along the Y-axis, and  $84 \pm 1$  mm in width along the X-axis as shown in Figure 2 (a). The impact face shall be  $30 \pm 1$  mm in radius,  $30 \pm 1$  mm in width along the Y-axis, and  $48 \pm 1$  mm in width along the X-axis as shown in Figure 2 (a).
- 1.3. The cross-sectional shape perpendicular to the Z-axis of the knee joint shall be  $108 \pm 2$  mm in width along the Y-axis, and  $118 \pm 1$  mm in width along the X-axis as shown in Figure 2 (b). The impact face shall be  $103 \pm 1$  mm in radius,  $12 \pm 1$  mm in width along the Y-axis, and  $86 \pm 1$  mm in width along the X-axis as shown in Figure 2 (b).
- 1.4. The masses of the femur and tibia without flesh, including the connection part to the knee joint, shall be  $2.46 \pm 0.12$  kg and  $2.64 \pm 0.13$  kg respectively. The mass of the knee joint without flesh shall be  $4.28 \pm 0.21$  kg. The total mass of the femur, knee joint, and tibia shall be  $9.38 \pm 0.47$  kg.

The centre of gravity of the femur and tibia without flesh, including the connection part to the knee joint, shall be  $159 \pm 8$  mm and  $202 \pm 10$  mm respectively from the top, but not including the connection part to the knee joint, of each part as shown in Figure 1. The centre of gravity of the knee shall be  $92 \pm 5$  mm from the top of the knee joint as shown in Figure 1.

The moment of inertia of the femur and tibia without flesh, including the connection part inserted to the knee joint, about the X-axis through the respective centre of gravity shall be  $0.0325 \pm 0.0016$  kgm<sup>2</sup> and  $0.0467 \pm 0.0023$  kgm<sup>2</sup> respectively. The moment of inertia of the knee joint about the X axis through the respective centre of gravity shall be  $0.0180 \pm 0.0009$  kgm<sup>2</sup>.

- 1.5. For each test, the impactor (femur, knee joint, and tibia) shall be covered by flesh composed of synthetic rubber sheets (R1, R2) and neoprene sheets (N1F, N2F, N1T, N2T, N3) as shown in Figure 3. The sheets are required to have a compression characteristic as shown in Figure 4. The compression characteristic shall be checked using the same batch of sheets as those used for the impactor flesh. The size of the sheets shall be within the requirements described in Figure 3.
- 1.6. The test impactor or at least the flesh shall be stored for at least four hours in a controlled storage area with a stabilized temperature of  $20 \pm 2^\circ\text{C}$  prior to impactor removal for calibration. After removal from the storage, the impactor shall not be subjected to conditions other than those pertaining to the test area.
2. Lower legform II instrumentation
  - 2.1. Four transducers shall be installed in the tibia to measure bending moments applied to the tibia. The sensing locations of each of the transducers are as follows: tibia-1:  $134 \pm 1$  mm, tibia-2:  $214 \pm 1$  mm, tibia-3:  $294 \pm 1$  mm, and tibia-4:  $374 \pm 1$  mm below the knee joint centre respectively as shown in Figure 5. The measurement axis of each transducer shall be the X-axis of the impactor.
  - 2.2. Three transducers shall be installed in the knee joint to measure elongations of the medial collateral ligament (MCL), anterior cruciate ligament (ACL), and posterior cruciate ligament (PCL). The measurement locations of each transducer are shown in Figure 5. The measurement locations shall be within  $\pm 4$  mm along the X axis from the knee joint centre.
  - 2.3. The instrumentation response value channel frequency class (CFC), as defined in ISO 6487:2002, shall be 180 for all transducers. The CAC response values, as defined in ISO 6487:2002, shall be 30 mm for the knee ligament elongations and 400 Nm for the tibia bending moments. This does not require that the impactor itself be able to physically elongate or bend until these values.
  - 2.4. The measurements for the Lower legform II shall be taken only for the major impact with the vehicle prior to the rebound phase. All maxima occurring during or after the rebound phase shall be ignored. For example, the zero crossing after the maximum of the MCL elongation or of the tibia bending moments shall be considered as the end of the major impact with the vehicle."

Paragraphs 1.1. to 2.4.(former), shall be deleted

Insert new Figures 1 to 5, to read:

"Figure 1

**Lower legform II; dimensions and C.G. locations of femur, knee joint and tibia (Side view)**

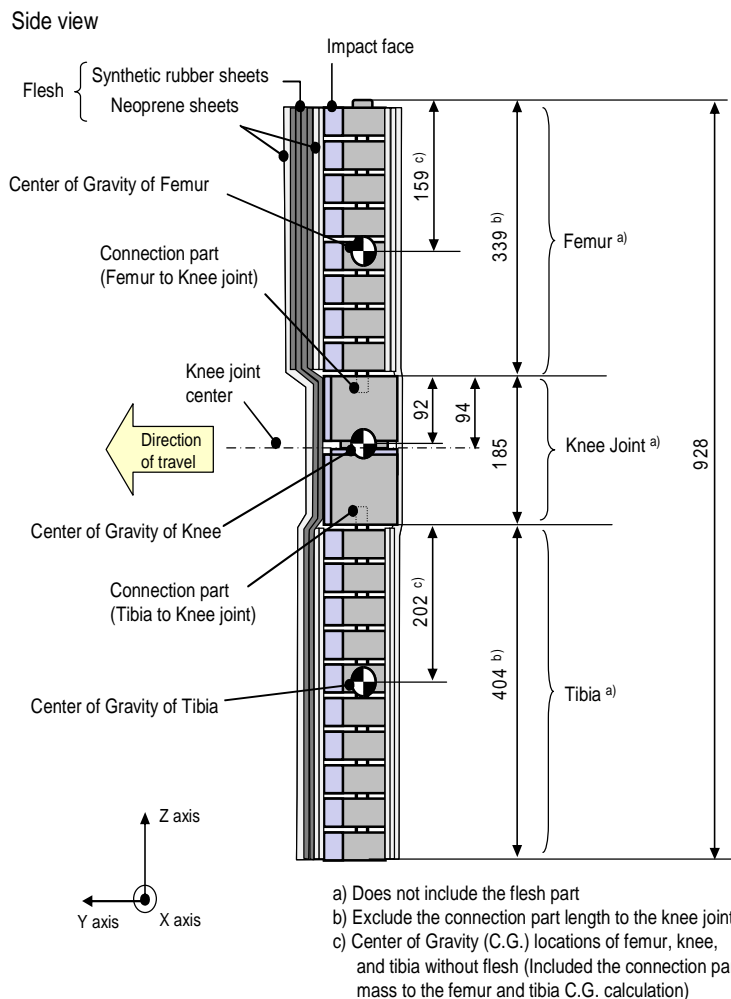

Figure 2  
**Lower legform II; femur, tibia, and knee dimensions (Top view)**

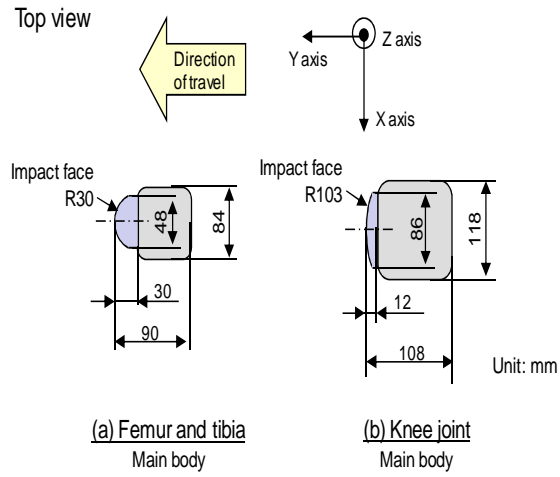

Figure 3  
**Lower legform II: flesh dimensions**

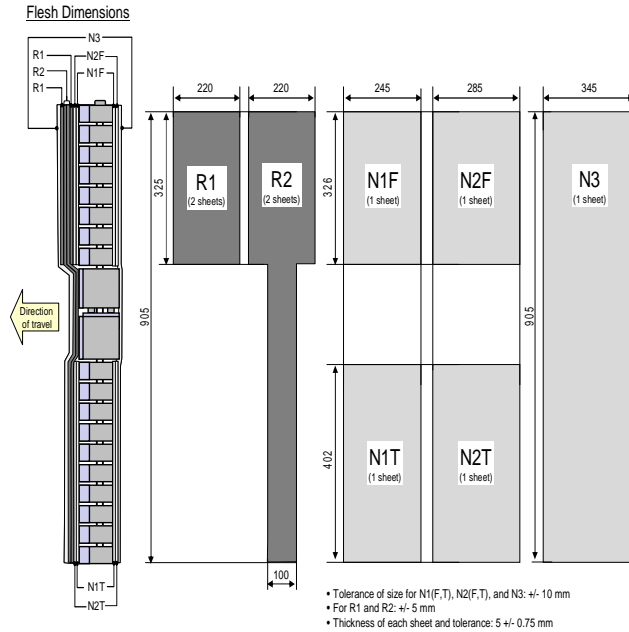
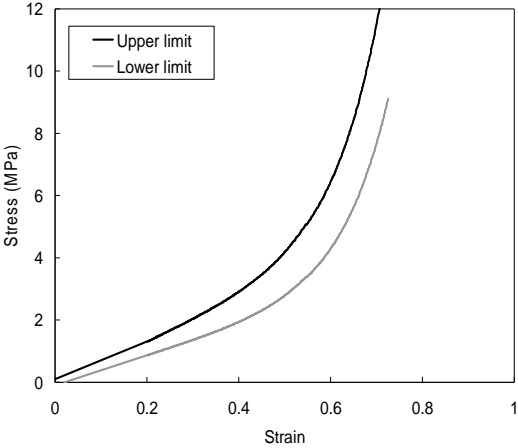

Figure 4  
Lower legform II; flesh compression characteristics

(a) Synthetic rubber sheets



(b) Neoprene sheets

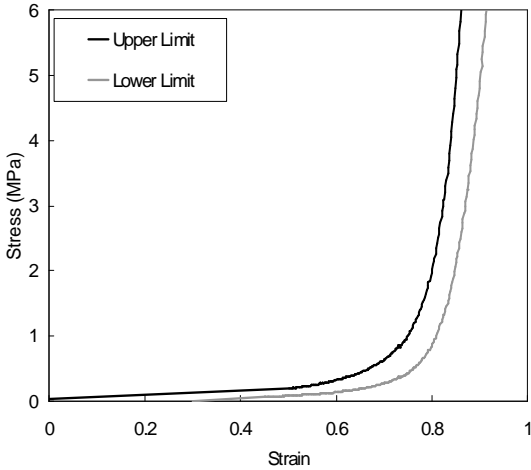

Figure 5  
**Lower legform II; instrument locations**

Instruments locations

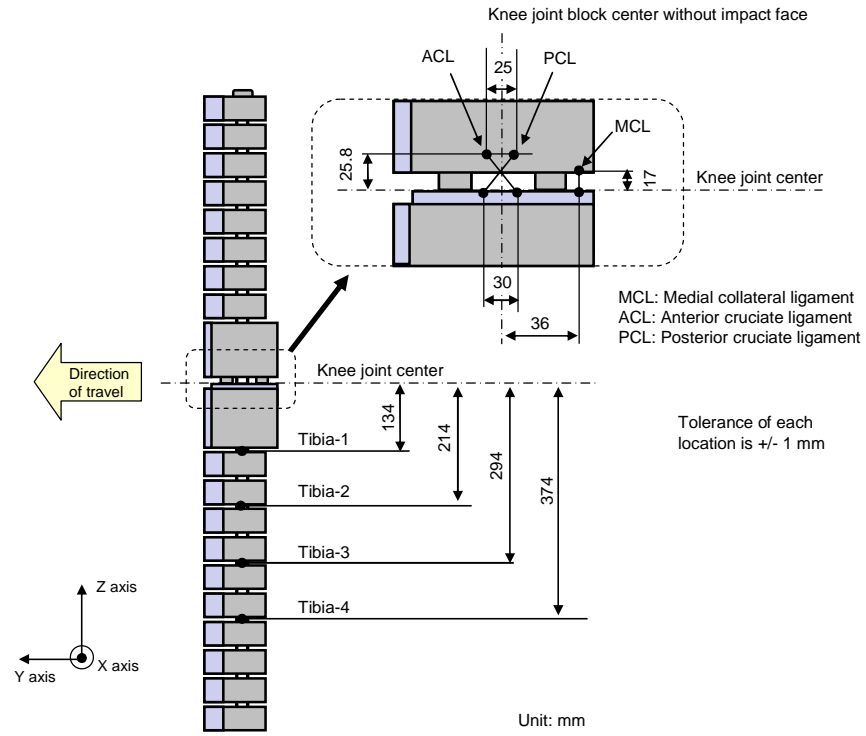

Figure 1 (former), shall be deleted

Paragraph 3.1., amend to read:

"3.1. ... and  $350 \pm 5$  mm long (see Figure 6)."

Paragraph 4.2., amend to read:

"4.2. ... side of the centre line (see Figure 6)."

Figure 2. (former), renumber as Figure 6.

Paragraph 5.1., amend to read:

"5.1. ... Child headform impactor (see Figure 7)."

Paragraph 5.2.2., amend to read:

"5.2.2. ... perpendicular to the mounting face A (see Figure 7) and its seismic mass ..."

Figure 3. (former), renumber as Figure 7.

Paragraph 5.3., amend to read:

"5.3. ... Adult headform impactor (see Figure 8)."

Figure 4. (former), renumber as Figure 8.



Paragraph 5.4.2., amend to read:

"5.4.2. ... perpendicular to the mounting face A (see Figure 8) and its seismic mass ..."

Annex 5

Paragraph 1., amend to read:

"1. **Lower legform II** ~~Lower legform~~ to bumper"

Insert new paragraphs 1.1. to 1.10., to read:

- 1.1. Each test shall be completed within two hours of when the impactor to be used is removed from the controlled storage area.**
- 1.2. The selected target points shall be in the bumper test area.**
- 1.3. A minimum of three lower legform to bumper tests shall be carried out, one each to the middle and the outer thirds of the bumper at positions judged to be the most likely to cause injury. Tests shall be to different types of structure, where they vary throughout the area to be assessed. The selected test points shall be a minimum of 132 mm apart, and a minimum of 66 mm inside the defined corners of the bumper. These minimum distances are to be set with a flexible tape held tautly along the outer surface of the vehicle. The positions tested by the laboratories shall be indicated in the test report.**
- 1.4. The direction of the impact velocity vector shall be in the horizontal plane and parallel to the longitudinal vertical plane of the vehicle. The tolerance for the direction of the velocity vector in the horizontal plane and in the longitudinal plane shall be  $\pm 2^\circ$  at the time of first contact. The axis of the impactor shall be perpendicular to the horizontal plane, with a roll and pitch angle tolerance of  $\pm 2^\circ$  in the lateral and longitudinal plane. The horizontal, longitudinal and lateral planes are orthogonal to each other (see Figure 1).**
- 1.5. The bottom of the impactor shall be at 75 mm above ground reference plane at the time of first contact with the bumper (see Figure 2), with a  $\pm 10$  mm tolerance. When setting the height of the propulsion system, an allowance must be made for the influence of gravity during the period of free flight of the impactor.**
- 1.6. The lower legform impactor for the bumper tests shall be in 'free flight' at the moment of impact. The impactor shall be released to free flight at such a distance from the vehicle that the test results are not influenced by contact of the impactor with the propulsion system during rebound of the impactor.**  
**The impactor may be propelled by any means that can be shown to meet the requirements.**
- 1.7. At the time of first contact the impactor shall have the intended orientation about its vertical axis, for the correct operation of its knee joint, with a yaw angle tolerance of  $\pm 5^\circ$  (see Figure 1).**
- 1.8. At the time of first contact the centre line of the impactor shall be within a  $\pm 10$  mm tolerance to the selected impact location.**
- 1.9. During contact between the impactor and the vehicle, the impactor shall not contact the ground or any object which is not part of the vehicle.**

**1.10. The impact velocity of the impactor when striking the bumper shall be  $11.1 \pm 0.2$  m/s. The effect of gravity shall be taken into account when the impact velocity is obtained from measurements taken before the time of first contact."**

*Paragraphs 1.1. to 1.12. (former), shall be deleted:*

*Figures 1 and 2, amend to read:*

"Figure 1

**Tolerances of angles for the Lower legform II at the time of the first impact (see paragraphs 1.4. and 1.7.)**

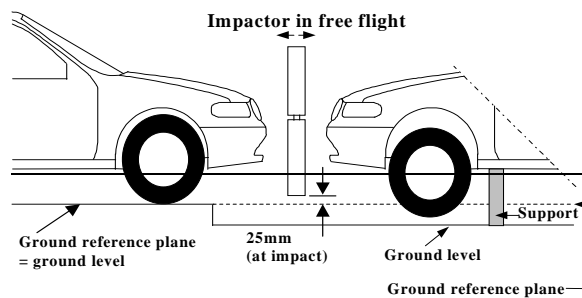
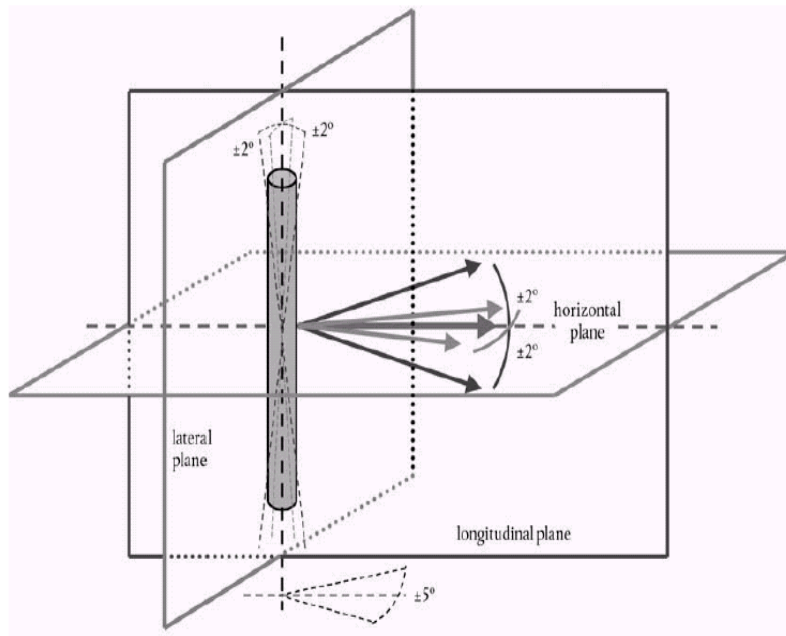
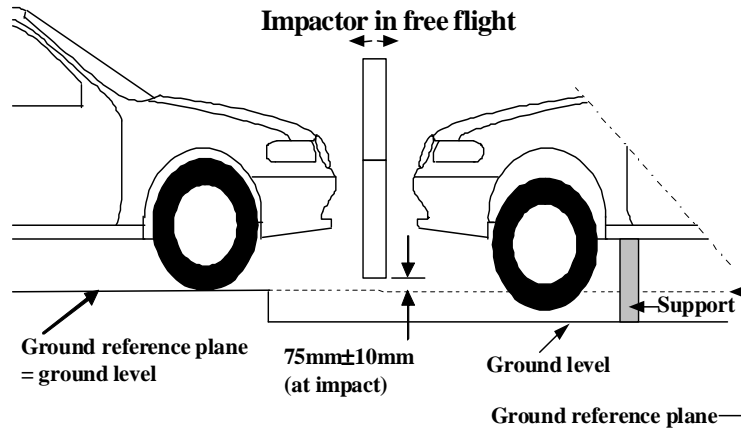

Figure 2:  
 Lower legform II to bumper tests for complete vehicle in normal ride attitude (left) and for cut-body mounted on supports (right) (see paragraph 1.5.)



#### Annex 6

Paragraph 1., amend to read:

"1. **Lower legform II** ~~Lower legform impactor~~ certification"

Insert new paragraphs 1.1. to 1.4.4.4., to read:

"1.1 [The impactor shall be certified according to the inverse type dynamic certification test described in paragraph 1.4.. After the initial inverse type dynamic certification test, the certified impactor shall be re-certified according to the pendulum type dynamic certification test described in paragraph 1.3. after every 10 vehicle tests, except for the inverse type dynamic certification test which will be repeated instead after every 30 vehicle tests.]

or

[The impactor be certified according to the inverse type dynamic certification test described in paragraph 1.4. (test A). After 10 vehicle tests, the certified impactor shall be re-certified according to the pendulum type dynamic certification test described in paragraph 1.3. (test B). After every subsequent 10 vehicle tests, the impactor shall be re-certified according to one of the two tests in the following sequence – B, A, B, B, A, B, B, ....]

The impactor shall be re-certified by these dynamic tests if more than one year has elapsed since the previous dynamic certification tests, if any impactor transducer output has exceeded the specified CAC. If the impactor fails the dynamic certification tests, it shall be re-certified by using the static calibration test described in paragraph 1.2. in order to identify the parts that shall be changed to new ones.

1.2. Static certification tests

- 1.2.1. The femur and tibia of the lower legform impactor shall meet the requirements respectively specified in paragraph 1.2.2. when tested as specified in paragraph 1.2.4. The knee joint of the lower legform impactor shall meet the requirements specified in paragraph 1.2.3. when tested as specified in paragraph 1.2.5. The stabilized temperature of the impactor during the certification tests shall be  $20^{\circ} \pm 2^{\circ}\text{C}$ .
- The CAC response values, as defined in ISO 6487:2002, shall be 30 mm for the knee ligament elongations and 4 kN for the applied external load. For these tests low-pass filtering at an appropriate frequency is permitted, to remove higher frequency noise without significantly affecting the measurement of the response of the impactor.
- 1.2.2. When the femur and tibia of the impactor are loaded in bending in accordance with paragraph 1.2.4., the applied moment and generated deflection at the centre of the femur and tibia ( $M_c$  and  $D_c$ ) shall be within the corridors shown in Figure 1.
- 1.2.3. When the knee joint of the impactor is loaded in bending in accordance with paragraph 1.2.5., the MCL, ACL and PCL elongations and applied bending moment or force at the centre of the knee joint ( $M_c$  or  $F_c$ ) shall be within the corridors shown in Figure 2.
- 1.2.4. The edges of the femur and tibia, not bending parts, shall be mounted to the support rig firmly as shown in Figure 3 and Figure 4. The Y-axis of the impactor shall be parallel to the loading axis within  $180 \pm 2^{\circ}$  tolerance. In order to avoid friction errors, roller plates shall be set underneath the support rigs.
- The centre of the loading force shall be applied at the centre of the femur and tibia within  $\pm 2^{\circ}$  tolerance along the Z-axis. The force shall be increased at a rate between 10 and 100 mm/minute until the bending moment at the centre part ( $M_c$ ) of the femur or tibia reaches 400 Nm.
- 1.2.5. The edges of the knee joint, not bending parts, shall be mounted to the support rig firmly as shown in Figure 5. The Y-axis of the impactor shall be parallel to the loading axis within  $180 \pm 2^{\circ}$ . In order to avoid friction errors, roller plates shall be set underneath the support rigs. To avoid impactor damage, a neoprene sheet shall be set underneath the loading ram and the impactor face of the knee joint which is described in the Figure 2 of Annex 4 shall be removed. The neoprene sheet used in this test shall have compression characteristics as shown in Figure 4 of Annex 4.
- The centre of the loading force shall be applied at the centre of the knee joint within  $\pm 2^{\circ}$  tolerance along the Z-axis. The external load shall be increased at a rate between 10 and 100 mm/minute until the bending moment at the centre part of the knee joint ( $M_c$ ) reaches 400 Nm.
- 1.3. Dynamic certification tests (pendulum type)
- 1.3.1. The lower legform impactor (femur, knee joint and tibia are connected/assembled firmly) shall meet the requirements specified in paragraph 1.3.3. when tested as specified in paragraph 1.3.4.
- 1.3.2. Certification
- 1.3.2.1. The test facility used for the certification test shall have a stabilized temperature of  $20 \pm 2^{\circ}\text{C}$  during certification.

- 1.3.2.2. The temperature of the certification area shall be measured at the time of certification and recorded in a certification report.
- 1.3.3. Requirements
- 1.3.3.1. When the lower legform impactor is used for a test as specified in paragraph 1.3.4., the maximum bending moment of the tibia at tibia-1 shall be not more than 272 Nm and not less than 235 Nm, the maximum bending moment at tibia-2 shall be not more than 211 Nm and not less than 185 Nm, the maximum bending moment at tibia-3 shall be not more than 160 Nm and not less than 135 Nm, and the maximum bending moment at tibia-4 shall be not more than 108 Nm and not less than 94 Nm. The maximum elongation of MCL shall be not more than 26 mm and not less than 23 mm, the maximum elongation of ACL shall be not more than 11 mm and not less than 9.0 mm, and the maximum elongation of PCL shall be not more than 5.4 mm and not less than 4.0 mm.
- For all these values, the readings used shall be from the initial impact timing to 250 ms after the impact timing.
- 1.3.3.2. The instrumentation response value CFC, as defined in ISO 6487:2002, shall be 180 for all transducers. The CAC response values, as defined in ISO 6487:2002, shall be 30 mm for the knee ligament elongations and 400 Nm for the tibia bending moments. This does not require that the impactor itself be able to physically elongate and bend to these values.
- 1.3.4. Test procedure
- 1.3.4.1. The impactor, including flesh, shall be suspended from the dynamic certification test rig  $15 \pm 1^\circ$  upward from the horizontal as shown in Figure 6. The impactor shall be released from the suspended position, whereupon the impactor falls freely against the pin joint of the test rig as shown in Figure 6.
- 1.3.4.2. The knee joint centre of the impactor shall be  $30 \pm 1$  mm below the bottom line of the stopper bar, and the tibia impact face without flesh shall be located  $13 \pm 2$  mm from the front upper edge of the stopper bar when the impactor is hanging freely as shown in Figure 6.
- 1.4. Dynamic certification tests (inverse type)
- 1.4.1. The lower legform impactor with flesh (femur, knee joint and tibia are connected/assembled firmly) shall meet the requirements specified in paragraph 1.4.3. when tested as specified in paragraph 1.4.4.
- 1.4.2. Certification
- 1.4.2.1. The test facility used for the certification test shall have a stabilized temperature of  $20 \pm 2$  °C during certification.
- 1.4.2.3. The temperature of the certification area shall be measured at the time of certification and recorded in a certification report.
- 1.4.3. Requirements
- 1.4.3.1. When the lower legform impactor is used for the test specified in paragraph 1.4.4., the maximum bending moment of the tibia at tibia-1 shall be not more than 277 Nm and not less than 237 Nm, the maximum bending moment at tibia-2 shall be not more than 269 Nm and not less

than 223 Nm, the maximum bending moment at tibia-3 shall be not more than 204 Nm and not less than 176 Nm, and the maximum bending moment at tibia-4 shall be not more than 120 Nm and not less than 98 Nm. The maximum elongation of the MCL shall be not more than 23 mm and not less than 18 mm, that of the ACL shall be not more than 10.5 mm and not less than 8.5 mm, and that of the PCL shall be not more than 6 mm and not less than 4.5 mm.

For all these values, the readings used shall be from the initial impact timing to 50 ms after the impact timing.

- 1.4.3.2. The instrumentation response value CFC, as defined in ISO 6487:2002, shall be 180 for all transducers. The CAC response values, as defined in ISO 6487:2002, shall be 30 mm for the knee ligament elongations and 400 Nm for the tibia bending moments. This does not require that the impactor itself be able to physically elongate and bend to these values.
- 1.4.4. Test procedure
- 1.4.4.1. The fully assembled Lower legform II (with flesh and skin) shall be stationary suspended vertically from a test rig as shown in Figure 7. It is then impacted by the upper edge of a linearly guided Al honeycomb impactor, covered by a thin (less than 1 mm thickness) paper cloth, at an impact speed of  $11.1 \pm 0.2$  m/s. The legform is to be released from the test rig within 10 ms after the time of first contact to ensure a free flight condition.
- 1.4.4.2. The honeycomb of 5052 alloy, which is attached in front of the moving ram, shall have a crush strength of 75 psi  $\pm$  10 per cent and dimensions of  $w = 200 \pm 5$  mm,  $l = 160 \pm 5$  mm and  $d = 60 \pm 2$  mm. To ensure a consistent and good level of repeatability, the honeycomb should either have a 3/16 inches cell size or a 1/4 inch cell size. The honeycomb should have a density of 2.0 pcf in combination with a 3/16 inch cell size or a density of 2.3 pcf in combination with a 1/4 inch cell size.
- 1.4.4.3. The upper edge of the honeycomb face is to be in line with the rigid plate of the linearly guided impactor. At time of first contact, the upper edge of the honeycomb is to be in line with the knee joint centre line within a vertical tolerance of  $0 \pm 2$  mm. The honeycomb shall not be deformed before the impact test.
- 1.4.4.4. The Lower legform II pitch angle and therefore the pitch angle of the velocity vector of the honeycomb impactor (rotation around Y-axis) at the time of first contact shall be within a tolerance of  $0 \pm 2^\circ$  in relation to the lateral vertical plane. The Lower legform II roll angle and therefore the roll angle of the honeycomb impactor (rotation around X-axis) at the time of first contact shall be within a tolerance of  $0 \pm 2^\circ$  in relation to the longitudinal vertical plane. The Lower legform II yaw angle and therefore the yaw angle of the velocity vector of the honeycomb impactor (rotation around Z-axis) at the time of first contact shall be within a tolerance of  $0 \pm 2^\circ$ , to ensure a correct operation of the knee joint."

*Paragraph 1.1. to 1.3.3.5.(former), shall be deleted*

*Paragraph 2.4.6., amend to read:*

"2.4.6. ... into the stationary pendulum as shown in Figure 8."

Paragraph 3.3.1., amend to read:

"3.3.1. ...suspended from a drop rig as shown in Figure 9."

Paragraph 3.3.3. of Annex 6, amend to read:

"3.3.3. ... respect to the vertical as shown in Figure 9. The suspension of the ..."

Insert new Figures 1 to 7, to read:

"Figure 1

**Lower legform II requirement corridor of femur and tibia in static certification test (see paragraph 1.2.2.)**

(a) Femur bending corridor

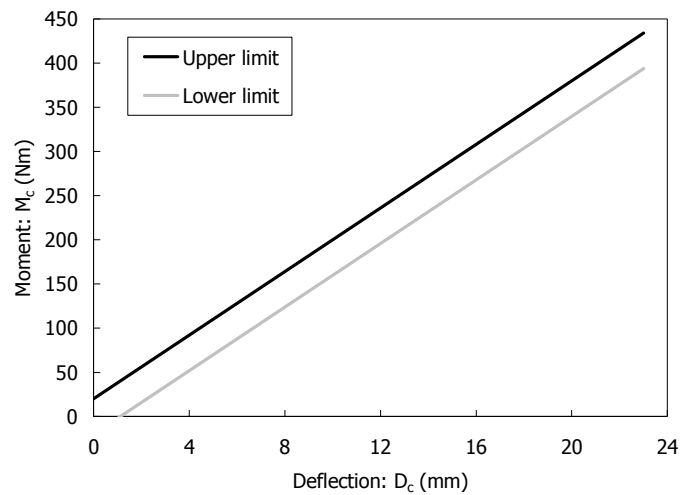

(b) Tibia bending corridor

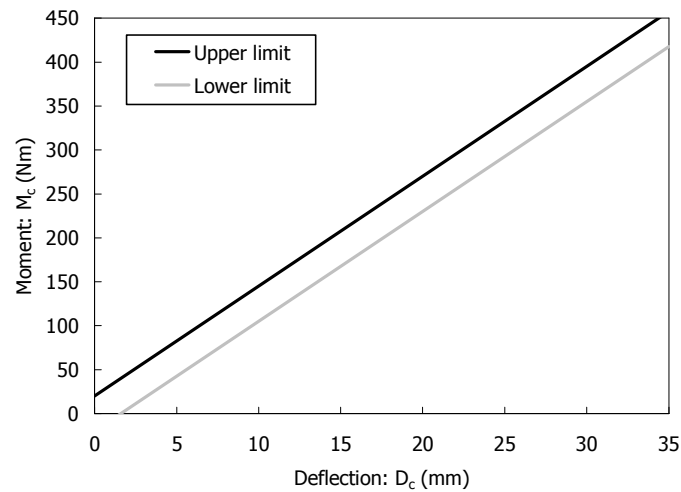
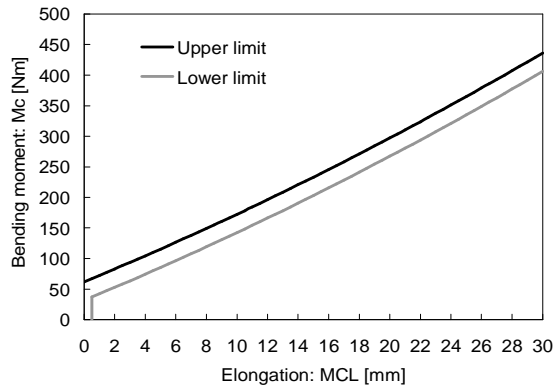
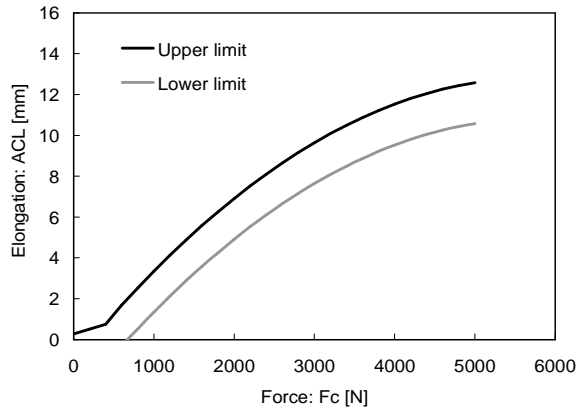

Figure 2  
**Lower legform II requirement corridors for knee joint in static certification test (see paragraph 1.2.3.)**



(a) for MCL



(b) for ACL

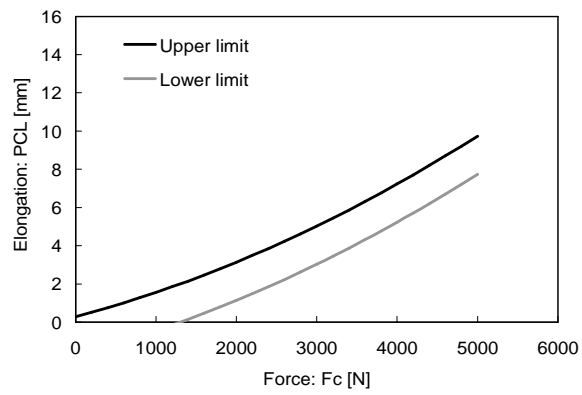

(c) for PCL



Figure 3  
 Lower legform II test set-up for femur in static certification tests (see paragraph 1.2.4.)

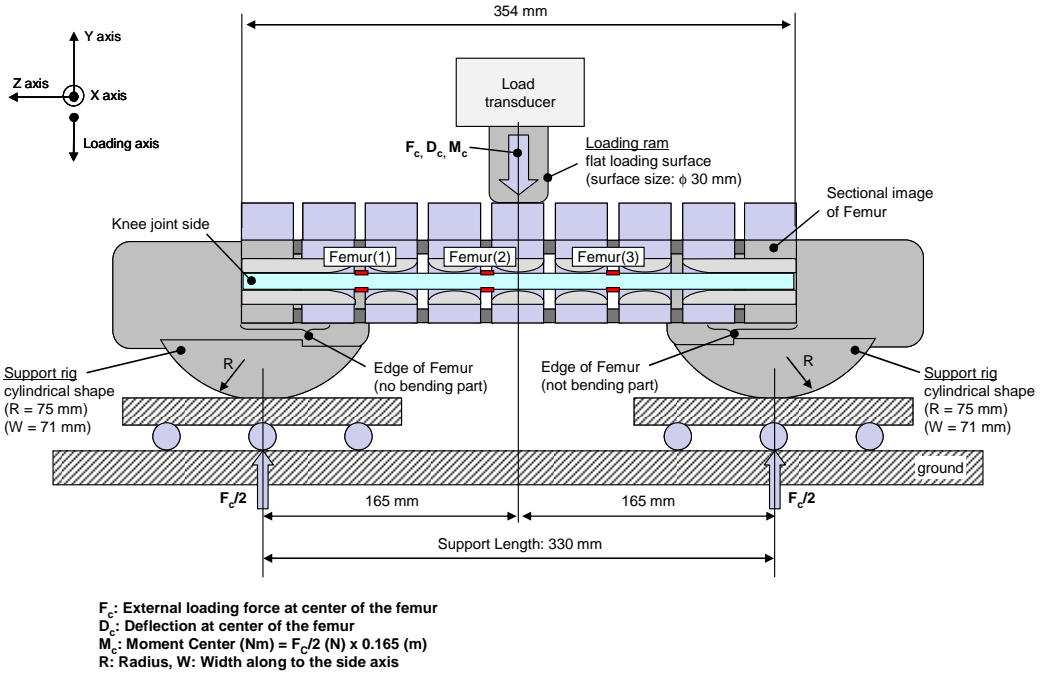

Figure 4:  
 Lower legform II test set-up for tibia in static certification test (see paragraph 1.2.4.)

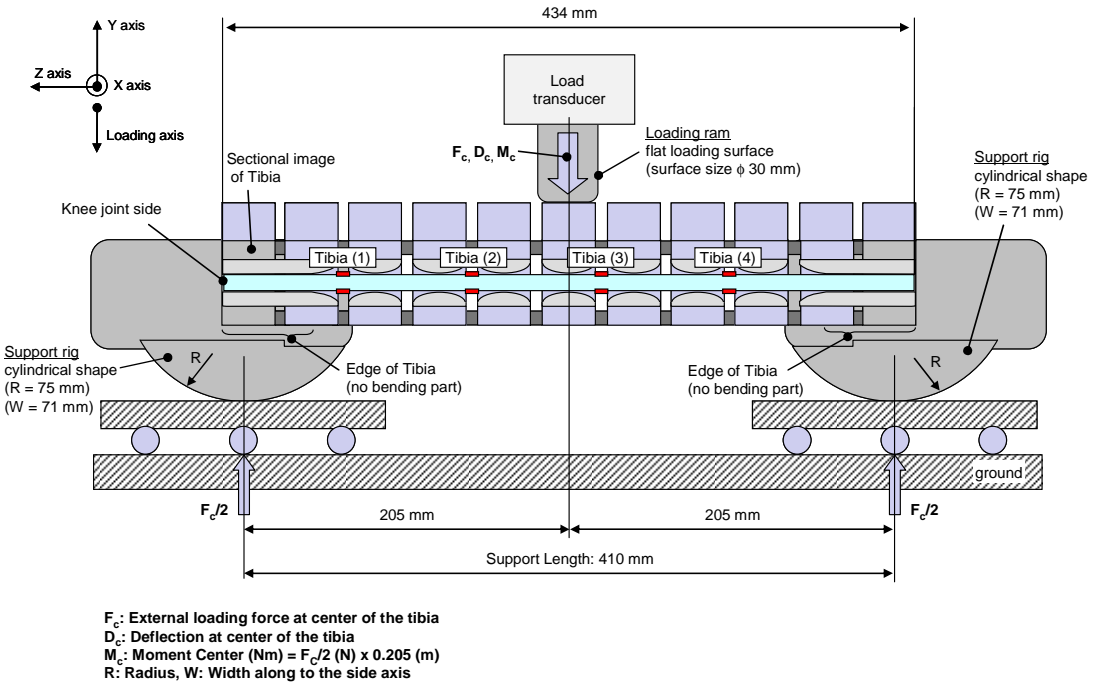

Figure 5:  
Lower legform II test set-up for knee joint in static certification test (see paragraph 1.2.5.)

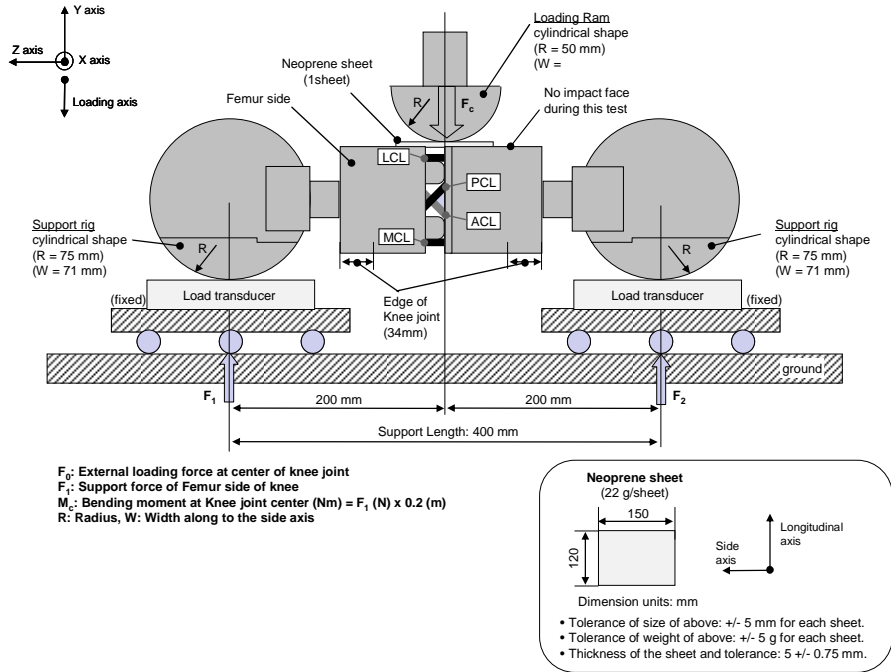

Figure 6  
Lower legform II test set-up for dynamic lower legform impactor certification test, Pendulum type (see paragraph 1.3.4.).

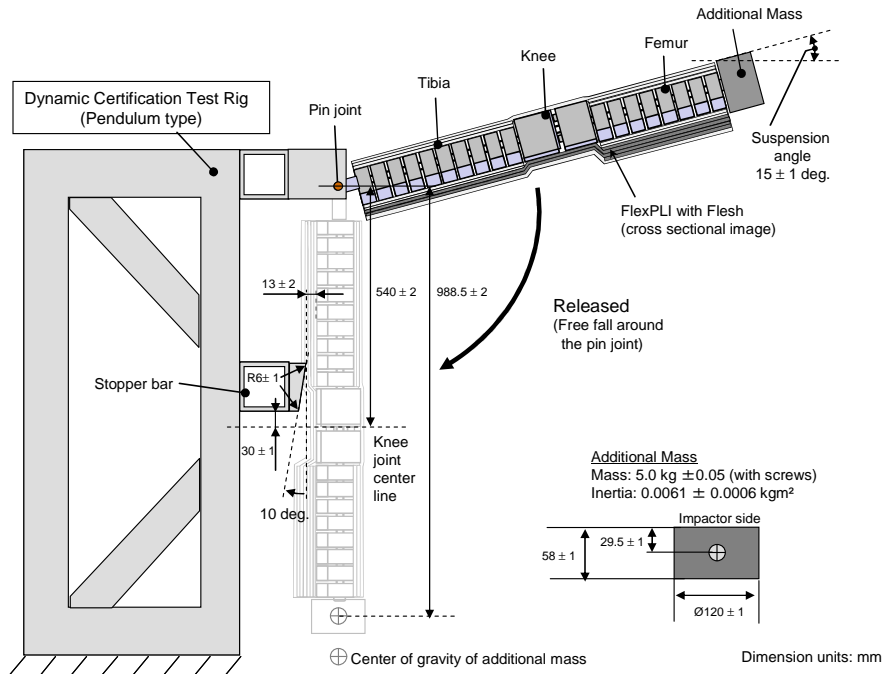
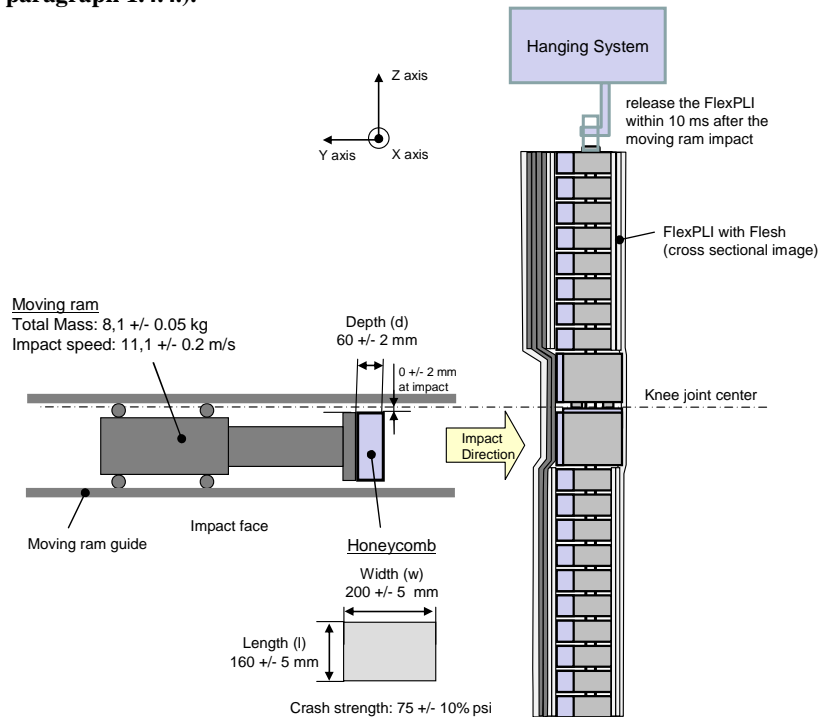

Figure 7  
**Lower legform II test set-up for dynamic lower legform impactor certification test, Inverse type**  
 (see paragraph 1.4.4.).



Figures 1 to 6 (former), shall be deleted:

Figures 7 and 8 (former), renumber as Figures 8 and 9.

## II. Justification

1. Based on the results of the technical evaluation group (TEG) activities, the expert from Japan proposes the draft amendments of the upcoming draft Regulation (ECE/TRANS/WP.29/2010/127) on pedestrian safety (as mentioned above).

*Insert New Paragraph 2.41.:* added "Lower legform II" definition.

*Paragraph 5.1.1:* added Lower legform II requirements.

*Insert New Paragraph 11.:* Provide appropriate transitional provisions based on the discussions of the forty-eighth session of GRSP.

*Paragraph 1. of Annex 4:* specified impactor type (editorial).

*Delete Paragraphs 1.1.to 2.4. (former) of Annex 4:* deleted 00 series sentences (editorial).

*Insert New Paragraph 1.1. to 2.4 of Annex 4:* added Lower legform II requirements.

*Delete Figure 1 of Annex 4:* deleted 00 series Figure (editorial).

*Insert new Figures 1 to 5 of Annex 4:* added Lower legform II figures.

*Paragraph 3.1. of Annex 4: renumbering (editorial).*

*Paragraph 4.2. of Annex 4: renumbering (editorial).*

*Figure 2. (former) of Annex 4: renumbering (editorial).*

*Paragraph 5.1. of Annex 4: renumbering (editorial)*

*Paragraph 5.2.2. of Annex 4: renumbering (editorial)*

*Figure 3. of Annex 4: renumbering (editorial).*

*Paragraph 5.3. of Annex 4: renumbering (editorial).*

*Figure 4. (former) of Annex 4: renumbering (editorial).*

*Paragraph 5.4.2. of Annex 4: renumbering (editorial).*

*Paragraph 1. of Annex 5: specified impactor type (editorial).*

*Deleted Paragraph 1.1. to 1.12. (former) of Annex 5: deleted 00 series requirements.*

*Insert new paragraphs 1.1. to 1.10. of Annex 5: added Lower legform II to bumper test procedure.*

*Figures 1 and 2. of Annex 5: amended figures related to the Lower legform II to bumper test procedure.*

*Paragraph 1. of Annex 6: specified impactor type (editorial).*

*Deleted Paragraph 1.1. to 1.3.3.5. (former) of Annex 6: deleted 00 series requirements (editorial).*

*Insert new paragraphs 1.1. to 1.4.4.4. of Annex 6: added Lower legform II certification method.*

*Delete Figures 1 to 6 (former) of Annex 6: deleted 00 series requirements. (editorial)*

*Insert new Figures 1 to 7. of Annex 6: added figures related to the Lower legform II certification method.*

*Paragraph 2.4.6. of Annex 6: renumbering (editorial).*

*Paragraph 3.3.1. of Annex 6: renumbering (editorial).*

*Paragraph 3.3.3. of Annex 6: renumbering (editorial).*

*Figures 7 and 8 (former) of Annex 6: renumbering (editorial).*