



**Economic and Social  
Council**

Distr.  
GENERAL

ECE/TRANS/WP.29/GRE/2006/47/Rev.1  
18 January 2008

Original: ENGLISH  
ENGLISH AND FRENCH ONLY

---

**ECONOMIC COMMISSION FOR EUROPE**

INLAND TRANSPORT COMMITTEE

World Forum for Harmonization of Vehicle Regulations

Working Party on Lighting and Light-Signalling

Fifty-ninth session

Geneva, 31 March - 4 April 2008

Item 8 of the provisional agenda

REGULATIONS Nos. 53 and 113

Proposal for draft amendments (Revision 2) to Regulation No. 113  
(Headlamps emitting a symmetrical passing beam)

Submitted by the expert from the International Motorcycle Manufacturers Association  
(IMMA) \*/

The text reproduced below was prepared by the expert from IMMA in order to introduce into the Regulation provisions on high-intensity discharge (HID) headlamps, as well as to revise the text of the Regulation. It supersedes ECE/TRANS/WP.29/GRE/2006/47 (see report ECE/TRANS/WP.29/GRE/58, para. 43). The modifications to the existing text of the Regulation, including Supplement 6 to the original version, with regard to introduction of HID provisions are marked in **bold** characters while some other suggested corrections are marked in *bold italic* characters.

---

\*/ In accordance with the programme of work of the Inland Transport Committee for 2006-2010 (ECE/TRANS/166/Add.1, programme activity 02.4), the World Forum will develop, harmonize and update Regulations in order to enhance performance of vehicles. The present document is submitted in conformity with that mandate.

A. JUSTIFICATION

This proposal will introduce HID with a symmetrical beam pattern to Regulation No. 113. The full rationale and the detailed research behind this proposal are contained in informal document No. GRE-56-07.

The HID beam pattern is based on the following elements:

- (a) above the HH line the beam remains the same as the other beam patterns in Regulation No. 113
- (b) below the HH line, the values for individual points have been raised but the highest increase still leaves the maximum value for that particular point at the same level as in Regulation No. 98, e.g. points 1 and 3.

The overall effect of these measures is to maintain the same level of comfort for the on-coming driver, while providing better illumination for the rider.

It is essential to remember that this proposal is inextricably linked with the amendment to Regulation No. 53, which requires a device for adjusting the vertical alignment of the headlamp that can be operated from the driver's seated position.

B. PROPOSAL

Regulation No. 113

UNIFORM PROVISIONS CONCERNING THE APPROVAL OF MOTOR VEHICLE HEADLAMPS EMITTING A SYMMETRICAL PASSING BEAM OR A DRIVING BEAM OR BOTH AND EQUIPPED WITH FILAMENT LAMPS **OR GAS-DISCHARGE LIGHT SOURCES**

CONTENTS

	<u>Page</u>
REGULATION	
A. ADMINISTRATIVE PROVISIONS	
0. Scope .....	5
1. Definitions .....	5
2. Application for approval of a headlamp .....	6
3. Markings .....	7
4. Approval .....	8
B. TECHNICAL REQUIREMENTS FOR HEADLAMPS	
5. General specifications.....	12
6. Illumination .....	14
7. Colour .....	20
C. FURTHER ADMINISTRATIVE PROVISIONS	
8. Modification of the headlamp type and extension of approval.....	20
9. Conformity of production .....	21
10. Penalties for non-conformity of production .....	21
11. Production definitely discontinued.....	22
12. Names and addresses of technical services responsible for conducting approval tests, and of administrative departments .....	22

CONTENTS (continued)

ANNEXES

- Annex 1 - Communication concerning the approval or extension or refusal or withdrawal of approval or production definitely discontinued of a type of headlamp pursuant to Regulation No. 113
- Annex 2 - Examples of arrangement of approval marks
- Annex 3 - Measuring screen
- Annex 4 - Tests for stability of photometric performance of headlamps in operation
- Annex 5 - Minimum requirements for conformity of production control procedures
- Annex 6 - Requirements for lamps incorporating lenses of plastic material - testing of lens or material samples and of complete lamps
  - Appendix 1 - Chronological order of approval tests
  - Appendix 2 - Method of measurement of the diffusion and transmission of light
  - Appendix 3 - Spray testing method
  - Appendix 4 - Adhesive tape adherence test
- Annex 7 - Minimum requirements for sampling by an inspector
- Annex 8 - Overview of operational periods concerning test for stability of photometric performance
- Annex 9 - Definition and sharpness of the "cut-off" line for symmetrical passing-beam headlamps and aiming procedure by means of this "cut-off" line
- Annex 10 - Centre of reference**
- Annex 11 - Voltage markings**

A. ADMINISTRATIVE PROVISIONS

0. SCOPE 1/ 2/

This Regulation applies to headlamps for vehicles of categories L and T. 3/

1. DEFINITIONS

For the purpose of this Regulation,

- 1.1. "Lens" means the outermost component of the headlamp (unit) which transmits light through the illuminating surface;
- 1.2. "Coating" means any product or products applied in one or more layers to the outer face of a lens;
- 1.3. "Headlamps of different types" mean headlamps which differ in such essential respects as:
- 1.3.1. the trade name or mark;
- 1.3.2. the characteristics of the optical system;
- 1.3.3. the inclusion or elimination of components capable of altering the optical effects by reflection, refraction, absorption and/or deformation during operation;
- 1.3.4. the kind of beam produced (passing beam, driving beam or both);
- 1.3.5. the materials constituting the lenses and coating, if any;
- 1.3.6. **the category of filament or gas-discharge light source;**
- 1.4. "Headlamps of different "Classes" (A or B or C or D or E)" mean headlamps identified by particular photometric provisions.
- 1.5. References made in this Regulation to standard (étalon) filament lamp(s) and to Regulation No. 37 shall refer to Regulation No. 37 and its series of amendments in force at the time of application for type approval.

---

1/ Application of headlamps is given in the relevant Regulations on the installation of lighting and light-signalling devices.

2/ Nothing in this Regulation shall prevent a Party to the Agreement applying this Regulation from prohibiting the combination of a headlamp incorporating a lens of plastic material approved under this Regulation with a mechanical headlamp-cleaning device (with wipers).

3/ As defined in Annex 7 to the Consolidated Resolution on the Construction of Vehicles (R.E.3), (document TRANS/WP.29/78/Rev.1/Amend.2 as last amended by Amend.4).

**1.6. "Ballast" means the electrical supply of the gas-discharge light source. This ballast may be partly or completely inside or outside the headlamp.**

2. APPLICATION FOR APPROVAL OF A HEADLAMP 4/

2.1. The application for approval shall be submitted by the owner of the trade name or mark or by his duly accredited representative. It shall specify:

2.1.1. whether the headlamp is intended to provide both a passing beam and a driving beam or only one of these beams;

2.1.2. whether it concerns a Class A or B or C or D **or E** headlamp;

2.1.3. the category of the filament lamp(s) used, as listed in Regulation No. 37 and its series of amendments in force at the time of application for type approval, **if any**.

**2.1.4. the category of gas-discharge light source as listed in Regulation No. 99, if any.**

2.2. Every application for approval shall be accompanied by:

2.2.1. drawings in triplicate in sufficient detail to permit identification of the type and representing a frontal view of the headlamp, with details of lens ribbing if any, and the cross-section; the drawings shall indicate the space reserved for the approval mark;

2.2.2. a brief technical description, **if any, including the make and type of the ballast(s)**;

2.2.3. two samples of the type of headlamp;

2.2.4. for Class B or C or D **or E** headlamps only, for the test of plastic material of which the lenses are made:

2.2.4.1. **for Class B or C or D, thirteen lenses; for Class E, fourteen lenses;**

2.2.4.1.1. **for Class B or C or D, six of these lenses may be replaced by six samples of material at least 60 x 80 mm in size, having a flat or convex outer surface and a substantially flat area (radius of curvature not less than 300 mm) in the middle measuring at least 15 x 15 mm;**

**for Class E, seven of these lenses may be replaced by seven samples of material at least 60 x 80 mm in size, having a flat or convex outer surface and a substantially flat area (radius of curvature not less than 300 mm) in the**

---

4/ For gas-discharge light sources see Regulation No. 99.

**middle measuring at least 15 x 15 mm;**

- 2.2.4.1.2. every such lens or sample of material shall be produced by the method to be used in mass production;
- 2.2.4.2. a reflector to which the lenses can be fitted in accordance with the manufacturer's instructions.
- 2.2.5. For Class E headlamps only, for testing the UV-resistance of light transmitting components made of plastic material against UV radiation of gas-discharge light sources inside the headlamp:**
  - 2.2.5.1. One sample each of the relevant material as being used in the headlamp or one headlamp sample containing these. Each material sample shall have the same appearance and surface treatment, if any, as intended for use in the headlamp to be approved.**
  - 2.2.5.2. The UV-resistance testing of internal materials to light source radiation is not necessary:**
    - 2.2.5.2.1. if low-UV-type gas-discharge light sources are being applied as specified in Regulation No. 99, or;**
    - 2.2.5.2.2. if provisions are taken to shield the relevant headlamp components from UV radiation, e.g. by glass filters.**
- 2.3. The materials making up the lenses and coatings, if any, shall be accompanied by the test report of the characteristics of these materials and coatings if they have already been tested.
- 3. MARKINGS
  - 3.1. Headlamps submitted for approval shall bear the trade name or mark of the applicant.
  - 3.2. They shall comprise, on the lens and on the main body, 5/ spaces of sufficient size for the approval mark and the additional symbols referred to in paragraph 4.; these spaces shall be indicated on the drawings referred to in paragraph 2.2.1. above.
  - 3.3. On the back of the headlamp the indication of the category of filament lamp **or gas-discharge light source** used.
  - 3.4. Class E headlamps may bear on their light-emitting surface a centre of reference as shown in Annex 10.**

---

5/ If the lens cannot be detached from the main body of the headlamp, a unique marking as specified in paragraph 4.2.5. shall be sufficient.

**3.5. Class E headlamps shall bear the voltage markings as shown in Annex 11.**

4. APPROVAL

4.1. General

4.1.1. If all the samples of a type of headlamp submitted pursuant to paragraph 2. above satisfy the provisions of this Regulation, approval shall be granted.

4.1.2. Where grouped, combined or reciprocally incorporated lamps satisfy the requirements of more than one Regulation, a single international approval mark may be affixed provided that each of the grouped, combined or reciprocally incorporated lamps satisfies the provisions applicable to it.

4.1.3. An approval number shall be assigned to each type approved. Its first two digits (at present 00) shall indicate the series of amendments incorporating the most recent major technical amendments made to the Regulation at the time of issue of the approval. The same Contracting Party may not assign the same number to another type of headlamp covered by this Regulation.

4.1.4. Notice of approval or of extension or refusal or withdrawal of approval or production definitely discontinued of a type of headlamp pursuant to this Regulation shall be communicated to the Parties to the 1958 Agreement applying this Regulation, by means of a form conforming to the model in Annex 1 to this Regulation.

4.1.5. In addition to the mark prescribed in paragraph 3.1., an approval mark as described in paragraphs 4.2. and 4.3. below shall be affixed in the spaces referred to in paragraph 3.2. above to every headlamp conforming to a type approved under this Regulation.

4.2. Composition of the approval mark

The approval mark shall consist of:

4.2.1. An international approval marking, comprising:



- 4.2.1.1. a circle surrounding the letter "E" followed by the distinguishing number of the country which has granted approval; 6/
- 4.2.1.2. the approval number prescribed in paragraph 4.1.3. above;
- 4.2.2. the following additional symbol:
  - 4.2.2.1. a horizontal arrow with a head on each end, pointing to the left and to the right;
  - 4.2.2.2. on headlamps meeting the requirements of this Regulation in respect of the passing beam only, the letters "C-AS" for Class A headlamps or "C-BS" for Class B headlamps or "WC-CS" for Class C headlamp or "WC-DS" for Class D headlamp **or "WC-ES" for Class E headlamps;**
  - 4.2.2.3. on headlamps meeting the requirements of this Regulation in respect of the driving beam only, "R-BS" for Class B headlamps or "WR-CS" for Class C headlamp or "WR-DS" for Class D headlamp **or "WR-ES" for Class E headlamps;**
  - 4.2.2.4. on headlamps meeting the requirements of this Regulation in respect of both the passing beam and the driving beam, the letters "CR-BS" for Class B headlamps or "WCR-CS" for Class C headlamp or "WCR-DS" for Class D headlamp **or "WCR-ES" for Class E headlamps;**
  - 4.2.2.5. on headlamps incorporating a lens of plastic material, the group of letters "PL" to be affixed near the symbols prescribed in paragraphs 4.2.1. and 4.2.2. above.

---

6/ 1 for Germany, 2 for France, 3 for Italy, 4 for the Netherlands, 5 for Sweden, 6 for Belgium, 7 for Hungary, 8 for the Czech Republic, 9 for Spain, 10 for **Serbia**, 11 for the United Kingdom, 12 for Austria, 13 for Luxembourg, 14 for Switzerland, 15 (vacant), 16 for Norway, 17 for Finland, 18 for Denmark, 19 for Romania, 20 for Poland, 21 for Portugal, 22 for the Russian Federation, 23 for Greece, 24 for Ireland, 25 for Croatia, 26 for Slovenia, 27 for Slovakia, 28 for Belarus, 29 for Estonia, 30 (vacant), 31 for Bosnia and Herzegovina, 32 for Latvia, 33 (vacant), 34 for Bulgaria, 35 (vacant), 36 for Lithuania, 37 for Turkey, 38 (vacant), 39 for Azerbaijan, 40 for The former Yugoslav Republic of Macedonia, 41 (vacant), 42 for the European Community (Approvals are granted by its Member States using their respective ECE symbol), 43 for Japan, 44 (vacant), 45 for Australia, 46 for Ukraine, 47 for Republic of South Africa, 48 for New Zealand, 49 for Cyprus, 50 for Malta, 51 for the Republic of Korea, 52 for Malaysia, 53 for Thailand, **54 and 55 (vacant), 56 for Montenegro, 57 (vacant) and 58 for Tunisia.** Subsequent numbers shall be assigned to other countries in the chronological order in which they ratify or accede to the Agreement Concerning the Adoption of Uniform Technical Prescriptions for Wheeled Vehicles, Equipment and Parts which can be Fitted and/or be Used on Wheeled Vehicles and the Conditions for Reciprocal Recognition of Approvals Granted on the Basis of these Prescriptions, and the numbers thus assigned shall be communicated by the Secretary-General of the United Nations to the Contracting Parties to the Agreement.

4.2.2.6. on headlamps, other than Class A, meeting the requirements of this Regulation in respect of the driving beam, an indication of the maximum luminous intensity expressed by a reference mark, as defined in paragraph 6.3.2.1.2. below, placed near the circle surrounding the letter "E";

4.2.3. In every case the relevant operating mode used during the test procedure according to paragraph 1.1.1.1. of Annex 4 and the permitted voltage(s) according to paragraph 1.1.1.2. of Annex 4 shall be stipulated on the approval forms and on the communication forms transmitted to the countries which are Contracting Parties to the Agreement and which apply this Regulation.

In the corresponding cases the device shall be marked as follows:

4.2.3.1. on headlamps meeting the requirements of this Regulation which are so designed that the filament **and/or gas-discharge light source** of the passing beam shall not be lit simultaneously with that of any other lighting function with which it may be reciprocally incorporated: an oblique stroke (/) shall be placed behind the passing lamp symbol in the approval mark.

4.2.4. The two digits of the approval number (at present 00) which indicate the series of amendments incorporating the most recent major technical amendments made to the Regulation at the time of issue of the approval and the arrow defined in paragraph 4.2.2.1. may be marked close to the above additional symbols.

4.2.5. The marks and symbols referred to in paragraphs 4.2.1. to 4.2.3. above shall be clearly legible and be indelible. They may be placed on an inner or outer part (transparent or not) of the headlamp, which cannot be separated from the transparent part of the headlamp emitting the light. In any case they shall be visible when the headlamp is fitted on the vehicle or when a movable part is opened.

4.3. Arrangement of the approval mark

4.3.1. Annex 2, figures 1 to 12, to this Regulation gives examples of arrangements of the approval mark with the above-mentioned additional symbols.

4.3.2. Grouped, combined or reciprocally incorporated lamps:

4.3.2.1. Where grouped, combined or reciprocally incorporated lamps have been found to comply with the requirements of several Regulations, a single international approval mark may be affixed, consisting of a circle surrounding the letter "E" followed by the distinguishing number of the country which has granted the approval, and an approval number. This approval mark may be located anywhere on the grouped, combined or reciprocally incorporated lamps, provided that:

4.3.2.1.1. it is visible as specified in paragraph 4.2.5.;

- 4.3.2.1.2. no part of the grouped, combined or reciprocally incorporated lamps that transmits light can be removed without at the same time removing the approval mark.
- 4.3.2.2. The identification symbol for each lamp appropriate to each Regulation under which approval has been granted, together with the corresponding series of amendments incorporating the most recent major technical amendments to the Regulation at the time of issue of the approval, and if necessary, the required arrow shall be marked:
- 4.3.2.2.1. either on the appropriate light-emitting surface,
- 4.3.2.2.2. or in a group, in such a way that each of the grouped, combined or reciprocally incorporated lamps may be clearly identified.
- 4.3.2.3. The size of the components of a single approval mark shall not be less than the minimum size required for the smallest of the individual marks by the Regulation under which approval has been granted.
- 4.3.2.4. An approval number shall be assigned to each type approved. The same Contracting Party may not assign the same number to another type of grouped, combined or reciprocally incorporated lamps covered by this Regulation.
- 4.3.2.5. Annex 2, figure **13**, to this Regulation gives examples of arrangements of approval marks for grouped, combined or reciprocally incorporated lamps with all the abovementioned additional symbols.
- 4.3.3. Lamps, the lens of which are used for different types of headlamps and which may be reciprocally incorporated or grouped with other lamps:
- The provisions laid down in paragraph 4.3.2. above are applicable.
- 4.3.3.1. In addition, where the same lens is used, the latter may bear the different approval marks relating to the different types of headlamps or units of lamps, provided that the main body of the headlamp, even if it cannot be separated from the lens, also comprises the space described in paragraph 3.2. above and bears the approval marks of the actual functions. If different types of headlamps comprise the same main body, the latter may bear the different approval marks.
- 4.3.3.2. Annex 2, figure **14**, to this Regulation gives examples of arrangements of approval marks relating to the above case.

B. TECHNICAL REQUIREMENTS FOR HEADLAMPS 7/

5. GENERAL SPECIFICATIONS

5.1. Each sample shall conform to the specifications set forth in paragraphs 6. to 8. below.

5.2. Headlamps shall be so made as to retain their prescribed photometric characteristics and to remain in good working order when in normal use, in spite of the vibrations to which they may be subjected.

5.2.1. Headlamps shall be fitted with a device enabling them to be so adjusted on the vehicles as to comply with the rules applicable to them. Such a device may or may not provide horizontal adjustment, provided that the headlamps are so designed that they can maintain a proper horizontal aiming even after the vertical aiming adjustment. Such a device need not be fitted on units in which the reflector and the diffusing lens cannot be separated, provided the use of such units is confined to vehicles on which the headlamp setting can be adjusted by other means.

Where a headlamp providing a passing beam and a headlamp providing a driving beam, each equipped with its own filament lamp **or gas-discharge light source**, are assembled to form a composite unit the adjusting device shall enable each optical system individually to be duly adjusted.

5.2.2. However, these provisions shall not apply to headlamp assemblies whose reflectors are indivisible. For this type of assembly the requirements of paragraph 6.3. of this Regulation apply.

**5.3. For Class A or B or C or D**

**5.3.1.** The headlamp shall be equipped with filament lamp(s) approved according to Regulation No. 37. Any Regulation No. 37 filament lamp may be used, provided that:

- (a) no restriction on the use is made in Regulation No. 37 and its series of amendments in force at the time of application for type approval;
- (b) for Class A and B, its reference luminous flux for dipped-beam does not exceed 600 lm;
- (c) for Class C and D, its objective luminous flux for dipped-beam does not exceed 2,000 lm.

---

7/ Technical requirements for filament lamps: see Regulation No. 37. **Technical requirements for gas-discharge light sources: see Regulation No. 99.**

- 5.3.2.** The design of the device shall be such that the filament lamp can be fixed in no other position but the correct one. 8/
- 5.3.3.** The filament lamp holder shall conform to the characteristics given in IEC Publication 60061. The holder data sheet relevant to the category of filament lamp used, applies.
- 5.4. For Class E**
- 5.4.1. The headlamp shall be equipped with gas-discharge light source(s) approved according to Regulation No. 99.**
- 5.4.2. In the case of replaceable gas-discharge light sources the lamp holder shall conform to the dimensional characteristics as given on the data sheet of IEC Publication 60061-2, relevant to the category of gas-discharge light source used. The gas-discharge light source shall fit easily into the headlamp.**
- 5.5.** In addition, Class B or C or D **or E** headlamps shall be complementary tested according to the requirements of Annex 4 to ensure that in use there is no excessive change in photometric performance.
- 5.6.** If the lens of a Class B or C or D **or E** headlamp is of plastic material, tests shall be done according to the requirements of Annex 6.
- 5.7.** On headlamps designed to provide alternately a driving beam and a passing beam, any mechanical, electromechanical or other device incorporated in the headlamp for switching from one beam to the other shall be so constructed that:
- 5.7.1.** the device is strong enough to withstand 50,000 operations without suffering damage despite the vibrations to which it may be subjected in normal use;
- 5.7.2.** in the case of failure it shall automatically obtain the passing beam position;
- 5.7.3.** either the passing beam or the driving beam shall always be obtained without any possibility of the mechanism stopping in between the two positions;
- 5.7.4.** the user cannot, with ordinary tools, change the shape or position of the moving parts.

---

8/ A headlamp is regarded as satisfying the requirements of this paragraph if the filament lamp can be easily fitted into the headlamp and the positioning lugs can be correctly fitted into their slots even in darkness.

**5.8. For Class E, the headlamp and ballast system shall not generate radiated or power line disturbances to cause a malfunction of other electric/electronic systems of the vehicle. 9/**

6. ILLUMINATION

6.1. General provisions

6.1.1. Headlamps shall be so made that they give adequate illumination without dazzle when emitting the passing beam, and good illumination when emitting a driving beam.

6.1.2. The illumination produced by the headlamp shall be determined by means of a vertical screen set up 25 m forward of the headlamp and at right angles to its axes as shown in Annex 3 to this Regulation.

**6.1.3. For Class A or B or C or D**

**6.1.3.1.** Headlamps shall be checked by means of an uncoloured standard (étalon) filament lamp designed for a rated voltage as indicated in the relevant data sheet of Regulation No. 37. During the checking of the headlamp, the voltage at the terminals of the filament lamp shall be regulated so as to obtain the reference luminous flux as indicated at the relevant data sheet of Regulation No. 37.

**6.1.3.2.** The headlamp shall be considered acceptable if it meets the requirements of this paragraph 6. with at least one standard (étalon) filament lamp, which may be submitted with the headlamp.

**6.1.4. For Class E**

**6.1.4.1.** The headlamp shall be deemed satisfactory if the photometric requirements set in the present paragraph 6. are met with one light source, which has been aged during at least 15 cycles, in accordance with Annex 4, paragraph 4. of Regulation No. 99.

**Where the gas-discharge light source is approved according to Regulation No. 99 it shall be a standard (étalon) light-source and its luminous flux may differ from the objective luminous flux specified in Regulation No. 99. In this case, the illuminances shall be corrected accordingly.**

**The above correction does not apply to distributed lighting systems using a nonreplaceable gas-discharge light source or to headlamps with the ballast(s) totally or partially integrated.**

---

**9/ Compliance with the requirements for electromagnetic compatibility is relevant to the individual vehicle type.**

**Where the gas-discharge light source is not approved according to Regulation No. 99 it shall be a production non-replaceable light source.**

- 6.1.4.2. The dimensions determining the position of the arc inside the standard gas-discharge light source are shown in the relevant data sheet of Regulation No. 99.**
- 6.1.4.3. Four seconds after ignition of a headlamp which has not been operated for 30 minutes or more, 60 lux at least must be reached at point HV of a driving beam and 6 lux at point 2 (0.86D-V) of a passing beam for headlamps incorporating driving beam and passing beam functions, or 6 lux at point point 2 (0.86D-V) for headlamps having only a passing beam function. The power supply shall be sufficient to secure the quick rise of the high current pulse.**
- 6.2. Provisions concerning passing beams
- 6.2.1. For a correct aiming the passing beam shall produce a sufficiently sharp "cut-off" to permit a satisfactory visual adjustment with its aid as indicated in paragraph 6. below. **The "cut-off" must be substantially horizontal and shall be as straight as possible from at least 3° L to 3° R.** In case that visual aim leads to problems or ambiguous positions, the instrumental method as specified in Annex 9, paragraphs 2. and 4., shall be applied and the quality or rather the sharpness of the "cut-off" and the linearity shall be checked on performance.
- 6.2.2. The headlamp shall be so aimed that:
- 6.2.2.1. For horizontal adjustment: The beam is as symmetrical as possible with reference to line V-V;
- 6.2.2.2. For vertical adjustment: the horizontal part of the "cut-off" line is adjusted to its nominal position 1 per cent below the H-H line which is 10 cm below the headlamp axis on the screen at 10 m distance or which is 25 cm below the headlamp axis on the screen at 25 m distance.
- If, however, vertical adjustment cannot be performed repeatedly to the required position within the allowed tolerances, the instrumental method of Annex 9, paragraphs 4. and 5. shall be applied to test compliance with the required minimum quality of the "cut-off" line and to perform the beam vertical adjustment.
- 6.2.3. When so aimed, the headlamp need, if its approval is sought solely for provision of a passing beam, 10/ comply with the requirements set out in paragraphs 6.2.5. to **6.2.7.1.** below; if it is intended to provide both a passing beam and a driving

---

10/ Such a special "passing beam" headlamp may incorporate a driving beam not subject to requirements.

beam, it shall comply with the requirements set out in paragraphs 6.2.5., 6.2.6. and 6.3.

6.2.4. Where a headlamp so aimed does not meet the requirements set out in paragraphs 6.2.5., 6.2.6. and 6.3., its alignment may be changed, except for headlamps that have no mechanism to adjust horizontal aim, on condition that the axis of the beam is not displaced laterally by more than 1 degree (= 44 cm) to the right or left 11/. To facilitate alignment by means of the "cut-off", the headlamp may be partially occulted in order to sharpen the "cut-off". However, the "cut-off" should not extend beyond the line H-H.

6.2.5. The illumination produced by the passing beam on the screens in Annex 3 shall meet the following illumination requirements:

6.2.5.1. For Class A headlamps:

Any point on and above the line H-H:	$\leq 0.32$ lux
Any point on line 25L-25R	$\geq 1.28$ lux
Any point on line 12.5L-12.5R	$\geq 0.64$ lux

6.2.5.2. For Class B headlamps:

Any point on and above the line H-H:	$\leq 0.7$ lux
Any point on line 50L-50R except 50V <u>*/</u>	$\geq 1.5$ lux
Point 50V	$\geq 3$ lux
Any point on line 25L-25R	$\geq 3$ lux
Any point in zone IV	$\geq 1.5$ lux

\*/ ratio of intensities  $\frac{50R}{50L} \geq 0.25$

---

11/ The limit of realignment of 1° towards the right or left is not incompatible with upward or downward vertical realignment. The latter is limited only by the requirements of paragraph 6.3. (the provisions of paragraph 6.3. are not applicable to passing beam headlamps).



6.2.5.3. For Class C or D headlamp:

Test point/ line/ zone	Position in B-β grid in angular degrees Vertical β <u>**</u> / Horizontal B <u>**</u> /		Required illumination in lux at 25 m			
			Minimum		Maximum	
			Class D	Class C	Class D	Class C
			> 125cc	≤ 125cc	> 125cc	≤ 125cc
1	0.86 D	3.5 R	2.3		15.4	
2	0.86 D	0	5.8	2.9	-	
3	0.86 D	3.5 L	2.3		15.4	
4	0.50 U	1.50L and 1.50R	-		1.08	
6	2.00 D	15 L and 15 R	1.28	0.64	-	
7	4.00 D	20 L and 20 R	0.38	0.19	-	
8	0	0	-		1.92	
Line 11	2.00 D	9 L to 9 R	1.6		-	
Line 12	7.00 U	10 L to 10 R	-		0.3; but 0.96 if within 2° cone	
Line 13	10.00 U	10 L to 10 R	-		0.15; but 0.64 if within 2° cone	
Line 14	10 U to 90 U	0	-		0.15; but 0.64 if within 2° cone	
15 <u>*/</u>	4.00 U	8.0 L	0.1 <u>*/</u>		1.08	
16 <u>*/</u>	4.00 U	0	0.1 <u>*/</u>		1.08	
17 <u>*/</u>	4.00 U	8.0 R	0.1 <u>*/</u>		1.08	
18 <u>*/</u>	2.00 U	4.0 L	0.2 <u>*/</u>		1.08	
19 <u>*/</u>	2.00 U	0	0.2 <u>*/</u>		1.08	
20 <u>*/</u>	2.00 U	4.0 R	0.2 <u>*/</u>		1.08	
21 <u>*/</u>	0	8.0 L and 8.0 R	0.1 <u>*/</u>		-	
22 <u>*/</u>	0	4.0 L and 4.0 R	0.2 <u>*/</u>		1.08	
Zone 1	1U/8L-4U/8L-4U/8R-1U/8R- 0/4R-0/1R-0.6U/0-0/1L-0/4L- 1U/8L		-		1.08	
Zone 2	>4U to <10 U	10 L to 10 R	-		0.3; but 0.96 if within 2° cone	
Zone 3	10 U to 90 U	10 L to 10 R	-		0.15; but 0.64 if within 2° cone	

Notes:

"D" means under the H-H line.  
"R" means right of the V-V line.

"U" means above the H-H line.  
"L" means left of the V-V line.

\*/ During measurement of these points, the front position lamp approved to ECE Regulation No. 50; if combined, grouped, or reciprocally incorporated shall be switched on.

\*\*/ 0.25° tolerance allowed independently at each test point for photometry unless indicated otherwise.

Other general text:

ECE type approval at reference luminous flux according to Regulation No. 37.

Nominal aim for photometry:

Vertical: 1 per cent D (0.57°D)                      Horizontal: 0°

Allowed tolerances for photometry:

Vertical: 0.3°D to 0.8°D                      Horizontal: ± 0.5°D L-R

6.2.6. The light shall be as evenly distributed as possible within zones 1, 2, and 3 for Class C or D headlamps.

**6.2.7. For Class E headlamp (gas-discharge headlamp for motorcycles):**

Test point/ line/ zone	Position in B-β grid in angular degrees		Required illumination in Lux at 25 m	
	Vertical β <u>**/</u>	Horizontal β <u>**/</u>	Minimum	Maximum
<b>1</b>	<b>0.86 D</b>	<b>3.5 R</b>	<b>4</b>	<b>20</b>
<b>2</b>	<b>0.86 D</b>	<b>0</b>	<b>8</b>	<b>-</b>
<b>3</b>	<b>0.86 D</b>	<b>3.5 L</b>	<b>4</b>	<b>20</b>
<b>4</b>	<b>0.50 U</b>	<b>1.50 L and 1.50 R</b>	<b>-</b>	<b>1.08</b>
<b>6</b>	<b>2.00 D</b>	<b>15 L and 15 R</b>	<b>2</b>	<b>-</b>
<b>7</b>	<b>4.00 D</b>	<b>20 L and 20 R</b>	<b>1</b>	<b>-</b>
<b>8</b>	<b>0</b>	<b>0</b>	<b>-</b>	<b>1.92</b>
<b>Line 11</b>	<b>2.00 D</b>	<b>9 L to 9 R</b>	<b>3</b>	<b>-</b>
<b>Line 12</b>	<b>7.00 U</b>	<b>10 L to 10 R</b>	<b>-</b>	<b>1.08</b>
<b>Line 13</b>	<b>10.00 U</b>	<b>10 L to 10 R</b>	<b>-</b>	<b>1.08</b>
<b>Line 14</b>	<b>10 U to 90 U</b>	<b>0</b>	<b>-</b>	<b>1.08</b>
<b>15 <u>*/</u></b>	<b>4.00 U</b>	<b>8.0 L</b>	<b>0.1 <u>*/</u></b>	<b>1.08</b>
<b>16 <u>*/</u></b>	<b>4.00 U</b>	<b>0</b>	<b>0.1 <u>*/</u></b>	<b>1.08</b>
<b>17 <u>*/</u></b>	<b>4.00 U</b>	<b>8.0 R</b>	<b>0.1 <u>*/</u></b>	<b>1.08</b>
<b>18 <u>*/</u></b>	<b>2.00 U</b>	<b>4.0 L</b>	<b>0.2 <u>*/</u></b>	<b>1.08</b>
<b>19 <u>*/</u></b>	<b>2.00 U</b>	<b>0</b>	<b>0.2 <u>*/</u></b>	<b>1.08</b>
<b>20 <u>*/</u></b>	<b>2.00 U</b>	<b>4.0 R</b>	<b>0.2 <u>*/</u></b>	<b>1.08</b>
<b>21 <u>*/</u></b>	<b>0</b>	<b>8.0 L and 8.0 R</b>	<b>0.1 <u>*/</u></b>	<b>-</b>
<b>22 <u>*/</u></b>	<b>0</b>	<b>4.0 L and 4.0 R</b>	<b>0.2 <u>*/</u></b>	<b>1.08</b>

<b>Zone 1</b>	<b>1U/8L-4U/8L-4U/8R-1U/8R-0/4R-0/1R-0.6U/0-0/1L-0/4L-1U/8L</b>		-	<b>1.08</b>
<b>Zone 2</b>	<b>&gt;4U to &lt;10 U</b>	<b>10 L to 10 R</b>	-	<b>1.08</b>
<b>Zone 3</b>	<b>10 U to 90 U</b>	<b>10 L to 10 R</b>	-	<b>1.08</b>

**Notes:**

"D" means under the H-H line. "U" means above the H-H line.

"R" means right of the V-V line. "L" means left of the V-V line.

**\*/** During measurement of these points, the front position lamp approved to Regulation No. 50, if combined, grouped, or reciprocally incorporated, shall be switched on.

**\*\*/** A 0.25° photometry tolerance is allowed independently at each test point, unless indicated otherwise.

**6.2.7.1.** The voltage applied to the terminals of the ballast(s) is: either: **13.5 V ± 0.1 V for 12 V systems or: otherwise specified (see Annex 11)**

**6.3.** Provisions concerning driving beams

**6.3.1.** In the case of a headlamp designed to provide a driving beam and a passing beam, measurements of the illumination produced on the screen by the driving beam shall be taken with the same headlamp alignment as applied to the condition of paragraphs 6.2. above; in the case of a headlamp providing a driving beam only, it shall be so adjusted that the area of maximum illumination is centred on the point of intersection of lines H-H and V-V; such a headlamp need meet only the requirements referred to in paragraph 6.3.

**6.3.2.** Except for Class A headlamp, the illumination produced on the screen by the driving beam shall meet the following requirements:

**6.3.2.1.** The point of intersection (HV) of lines H-H and V-V shall be situated within the isolux 80 per cent of maximum illumination. This maximum value ( $E_M$ ) shall not be less than 32 lux for Class B or C headlamps, **51.2 lux for Class D headlamps and 70 lux for Class E headlamps.** The maximum value shall in no circumstances exceed 240 lux in the case of Class B headlamps and 180 lux in the case of Class C, **D and E** headlamps.

**6.3.2.1.1.** The maximum intensity ( $I_M$ ) of the driving beam expressed in thousands of candelas shall be calculated by the formula:

$$I_M = 0.625 E_M$$

**6.3.2.1.2.** The reference mark ( $I'_M$ ) of this maximum intensity, referred to in paragraph 4.2.2.6. above, shall be obtained by the ratio:

$$I_M = \frac{IM}{3} = 0.280EM$$

This value shall be rounded off to the value 7.5 - 10 - 12.5 - 17.5 - 20 - 25 - 27.5 - 30 - 37.5 - 40 - 45 - 50.

- 6.3.2.2. Starting from point HV, horizontally to the right and left, the illumination shall be not less than 12 lux for Class B headlamp to a distance of 1,125 mm and not less than 3 lux for Class B headlamp to a distance of 2,250 mm.

In the case of a Class C, **D or E** headlamp, the intensities shall conform to the tables A or B in Annex 3. Table A applies in the case where a primary driving beam is being produced with a single light source. Table B applies in the case where the driving beam is being produced by a secondary driving beam headlamp operated with a harmonized passing beam headlamp or a primary driving beam headlamp.

- 6.4. In the case of headlamps with an adjustable reflector, additional tests shall be made after the reflector has been moved vertically  $\pm 2^\circ$  or at least into the maximum position, if less than  $2^\circ$ , from its initial position by means of the headlamp adjusting device. The whole headlamp shall then be re-positioned (for example by means of the goniometer) by moving it through the same number of degrees in the opposite direction to the movement of the reflector. The following measurements shall be made and the points shall be within the required limits:

passing beam:            points HV and 0.86 D-V  
driving beam:             $I_M$  and point HV (percentage of  $I_M$ ).

- 6.5. The screen illumination values mentioned in paragraphs 6.2. and 6.3. above shall be measured by means of a photoreceptor, the effective area of which shall be contained within a square of 65 mm side.

## 7. COLOUR

- 7.1. The colour of the light emitted shall be white. Expressed in CIE trichromatic coordinates, the light of the beams shall be within the following boundaries:

limit towards blue	$x \geq 0.310$
limit towards yellow	$x \leq 0.500$
limit towards green	$y \leq 0.150 + 0.640 x$
limit towards green	$y \leq 0.440$
limit towards purple	$y \geq 0.050 + 0.750 x$
limit towards red	$y \geq 0.382$

## C. FURTHER ADMINISTRATIVE PROVISIONS

## 8. MODIFICATION OF THE HEADLAMP TYPE AND EXTENSION OF APPROVAL

- 8.1. Every modification of the headlamp type shall be notified to the administrative department which approved the headlamp type. The said department may then either:
- 8.1.1. consider that the modifications made are unlikely to have appreciable adverse effects and that in any event the headlamp still complies with the requirements; or
  - 8.1.2. require a further test report from the technical service responsible for conducting the tests.
- 8.2. Confirmation or refusal of approval, specifying the alterations, shall be communicated by the procedure specified in paragraph 4.1.4. above to the Parties to the Agreement which apply this Regulation.
- 8.3. The competent authority issuing the extension of approval shall assign a series number to each communication form drawn up for such an extension and inform thereof the other Parties to the 1958 Agreement applying this Regulation by means of a communication form conforming to the model in Annex 1 to this Regulation.

## 9. CONFORMITY OF PRODUCTION

The conformity of production procedures shall comply with those set out in the Agreement, Appendix 2 (E/ECE/324-E/ECE/TRANS/505/Rev.2) with the following requirements:

- 9.1. Headlamps approved under this Regulation shall be so manufactured as to conform to the type approved by meeting the requirements set forth in paragraphs 6. and 7.
- 9.2. The minimum requirements for conformity of production control procedures set forth in Annex 5 to this Regulation shall be complied with.
- 9.3. The minimum requirements for sampling by an inspector set forth in Annex 7 to this Regulation shall be complied with.
- 9.4. The authority which has granted type approval may at any time verify the conformity control methods applied in each production facility. The normal frequency of these verifications shall be once every two years.
- 9.5. Headlamps with apparent defects are disregarded.

10. PENALTIES FOR NON-CONFORMITY OF PRODUCTION

10.1. The approval granted in respect of a type of headlamp pursuant to this Regulation may be withdrawn if the requirements are not complied with or if a headlamp bearing the approval mark does not conform to the type approved.

10.2. If a Contracting Party to the Agreement applying this Regulation withdraws an approval it has previously granted, it shall forthwith so notify the other Contracting Parties applying this Regulation by means of a communication form conforming to the model in Annex 1 to this Regulation.

11. PRODUCTION DEFINITELY DISCONTINUED

If the holder of the approval completely ceases to manufacture a type of headlamp approved in accordance with this Regulation, he shall so inform the authority which granted the approval. Upon receiving the relevant communication, that authority shall inform thereof the other Parties to the 1958 Agreement applying this Regulation by means of a communication form conforming to the model in Annex 1 to this Regulation.

12. NAMES AND ADDRESSES OF TECHNICAL SERVICES RESPONSIBLE FOR CONDUCTING APPROVAL TESTS, AND OF ADMINISTRATIVE DEPARTMENTS

The Parties to the 1958 Agreement applying this Regulation shall communicate to the United Nations Secretariat the names and addresses of the technical services responsible for conducting approval tests and of the administrative departments which grant approval and to which forms certifying approval or extension or refusal or withdrawal of approval, or production definitely discontinued, issued in other countries, are to be sent.

Annex 1

COMMUNICATION

(Maximum format: A4 (210 x 297 mm))

issued by :

Name of administration:

.....  
.....  
.....



concerning: 2/

- APPROVAL GRANTED
- APPROVAL EXTENDED
- APPROVAL REFUSED
- APPROVAL WITHDRAWN
- PRODUCTION DEFINITELY DISCONTINUED

of a type of headlamp pursuant to Regulation No. 113

Approval No.: .....

Extension No.: .....

1. Trade name or mark of the vehicle: .....
2. Manufacturer's name for the type of vehicle: .....
3. Manufacturer's name and address: .....
4. If applicable, name and address of manufacturer's representative:.....  
.....
5. Submitted for approval on: .....
6. Technical service responsible for conducting approval tests: .....
7. Date of report issued by that service: .....
8. Number of report issued by that service: .....
9. Brief description:  
Category as described by the relevant marking 3/: .....
- .....  
Number and category(ies) of filament lamp(s) or **gas-discharge light source**: .....

.....

The determination of "cut-off" sharpness yes / no 2/

If yes, it was carried out at 10 m / 25 m 2/ .....

**Trade name and identification number of separate ballast(s) or part(s) of ballast(s):** .....

**The passing beam light source may/may not 2/ be lit simultaneously with the driving beam light source and/or another reciprocally incorporated headlamp.**

- 10. Approval mark position: .....
- 11. Reason(s) for extension of approval: .....
- 12. Approval granted/extended/refused/withdrawn 2/: .....
- 13. Place: .....
- 14. Date: .....
- 15. Signature: .....
- 16. The list of documents deposited with the Administrative Service which has granted approval is annexed to this communication and may be obtained on request.

\_\_\_\_\_

1/ Distinguishing number of the country which has granted/extended/refused/withdrawn approval (see the provisions of the Regulation concerning approval).

2/ Strike out which does not apply.

3/ Indicate the appropriate marking selected from the list below:

- |                  |                   |                   |                   |                 |                  |
|------------------|-------------------|-------------------|-------------------|-----------------|------------------|
| C-AS,            | C-BS,             | R-BS,             | CR-BS,            | C/ -BS,         | C/R-BS,          |
|                  | C-BS PL,          | R-BS PL,          | CR-BS PL,         | C/ -BS PL,      | C/R-BS PL,       |
| WC-CS,           | WC-DS,            | WR-CS,            | WR-DS,            | WCR-CS,         | WCR-DS,          |
| WC/-CS,          | WC/-DS,           | WC/R-CS,          | WC/R-DS,          | WC-CS PL,       |                  |
| WC-DS PL,        | WR-CS PL,         | WR-DS PL,         | WCR-CS PL,        | WCR-DS PL,      |                  |
| WC/-CS PL,       | WC/-DS PL,        | WC/R-CS PL,       | WC/R-DS PL,       |                 |                  |
| WC+-CS,          | WC+-DS,           | WC+R-CS,          | WC+R-DS,          | C+-BS,          | C+R-BS,          |
| WC+-CS PL,       | WC+-DS PL,        | WC+R-CS PL,       | WC+R-DS PL,       | C+-BS PL,       | C+R-BS PL        |
| <b>WC-ES,</b>    | <b>WR-ES,</b>     | <b>WCR-ES,</b>    | <b>WC/-ES,</b>    | <b>WC/R-ES,</b> | <b>WC-ES PL,</b> |
| <b>WR-ES PL,</b> | <b>WCR-ES PL,</b> | <b>WC/-ES PL,</b> | <b>WC/R-ES PL</b> |                 |                  |
| <b>WC+-ES,</b>   | <b>WC+R-ES,</b>   | <b>WC+-ES PL,</b> | <b>WC+R-ES PL</b> |                 |                  |



Annex 2

EXAMPLES OF ARRANGEMENT OF APPROVAL MARKS

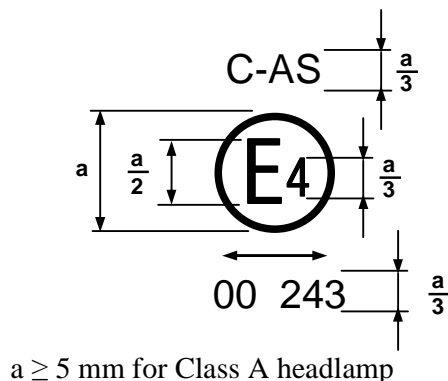

Figure 1

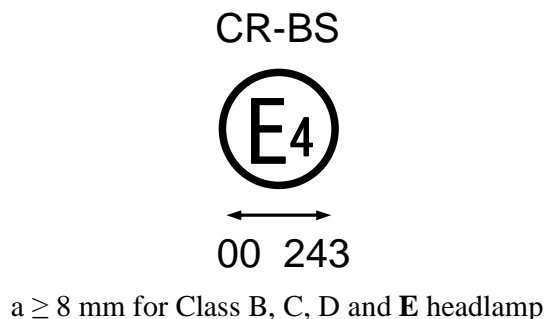

Figure 2

The headlamp bearing one of the above approval marks has been approved in the Netherlands (E 4) pursuant to Regulation No. 113 under approval number 243, meeting the requirements of this Regulation in its original form (00). The letters C-AS (figure 1) indicate that it concerns a Class A passing beam headlamp and the letters CR-BS (figure 2) indicate that it concerns a Class B passing and driving beam headlamp.

Note: The approval number and additional symbols shall be placed close to the circle and either above or below the letter "E", or to the right or left of that letter. The digits of the approval number shall be on the same side of the letter "E" and face in the same direction.

The use of Roman numerals as approval numbers should be avoided so as to prevent any confusion with other symbols.

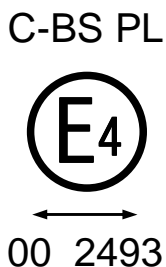

Figure 3

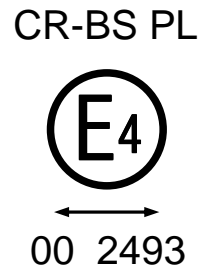

Figure 4

The headlamp bearing the above approval mark is a headlamp incorporating a lens of plastic material meeting the requirements of this Regulation and is designed:

Figure 3: Class B in respect of the passing beam only.

Figure 4: Class B in respect of the passing beam and driving beam.

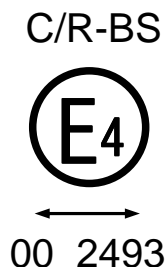

Figure 5

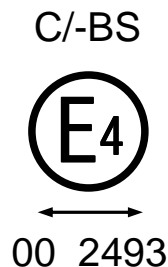

Figure 6

The headlamp bearing the above approval mark is a headlamp meeting the requirements of this Regulation:

Figure 5: Class B in respect of the passing beam and driving beam.

Figure 6: Class B in respect of the passing beam only.

The passing beam shall not be operated simultaneously with the driving beam and/or another reciprocally incorporated headlamp.

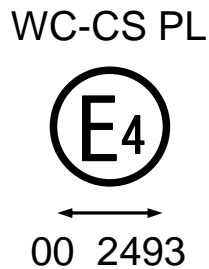

Figure 7

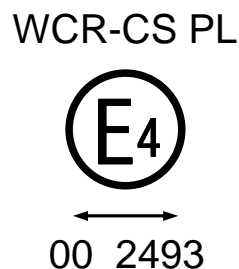

Figure 8

The headlamp bearing the above approval mark is a headlamp incorporating a lens of plastic material meeting the requirements of this Regulation and is designed:

Figure 7: Class C in respect of the passing beam only.

Figure 8: Class C in respect of the passing beam and driving beam.

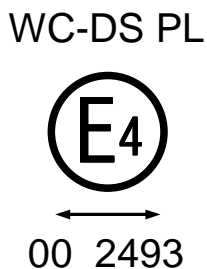

Figure 9

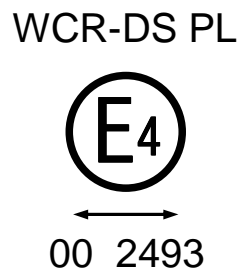

Figure 10

The headlamp bearing the above approval mark is a headlamp meeting the requirements of this Regulation:

*Figure 9: Class D in respect of the passing beam only.*

*Figure 10: Class D in respect of the passing beam and driving beam.*

The passing beam shall not be operated simultaneously with the driving beam and/or another reciprocally incorporated headlamp.

**WC-ES PL**



Figure 11

**WCR-ES**

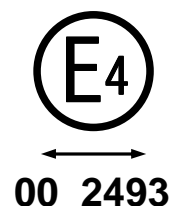

Figure 12

The headlamp bearing the above approval mark is a headlamp meeting the requirements of this Regulation:

**Figure 11: Class E in respect of the passing beam only.**

**Figure 12: Class E in respect of the passing beam and driving beam.**

Simplified marking for grouped, combined or reciprocally incorporated lamps

Figure 13

(The vertical and horizontal lines schematize the shape of the light-signalling device. They are not part of the approval mark).

Model A

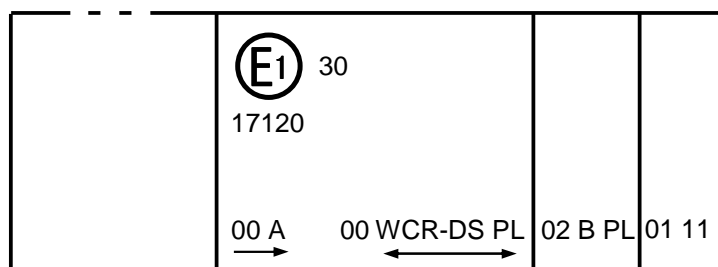

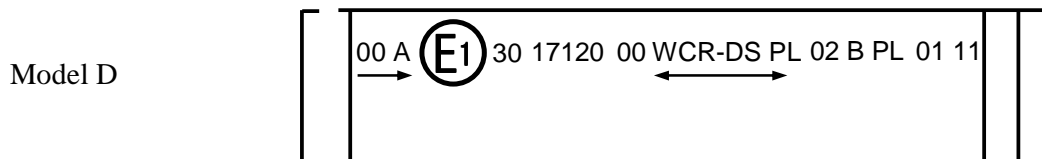
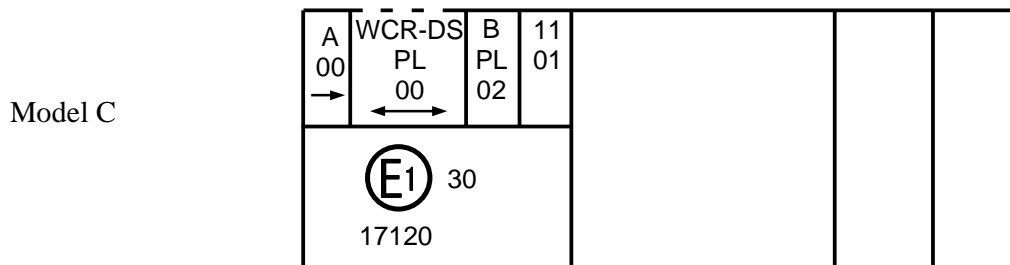
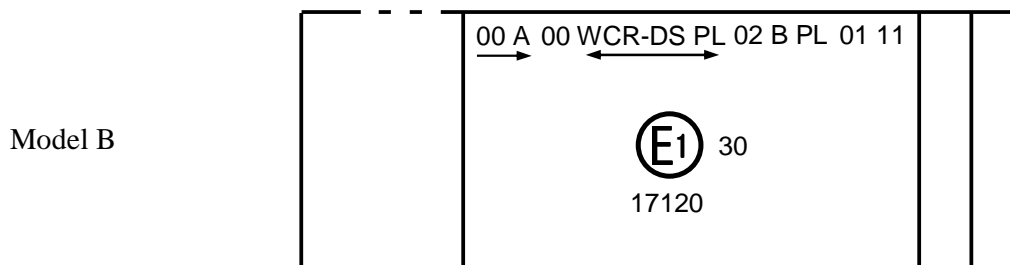

Note: The four examples above correspond to a lighting device bearing an approval mark comprising:

A front position lamp approved in accordance with Regulation No. 50 in its original form (00),

A headlamp, Class D, with a passing beam and a driving beam with a maximum intensity comprised between 86,250 and 101,250 candelas (as indicated by the number 30), approved in accordance with the requirements of this Regulation in its original form (00) and incorporating a lens of plastic material,

A front fog lamp approved in accordance with the 02 series of amendments to Regulation No. 19 and incorporating a lens of plastic material,

A front direction indicator lamp of Category 11 approved in accordance with the 01 series of amendments to Regulation No. 50.

**Figure 14**

Lamp reciprocally incorporated with a headlamp

Example 1



The above example corresponds to the marking of a lens of plastic material intended to be used in different types of headlamps, namely:

either

a headlamp, Class D, with a passing and a driving beam with a maximum luminous intensity comprised between 86,250 and 101,250 candelas (as indicated by the number 30), approved in Germany (E1) in accordance with the requirements of this Regulation in its original form (00), which is reciprocally incorporated with a front position lamp approved in accordance with Regulation No. 50 in its original form (00);

or

a headlamp, Class C, with a passing beam and a driving beam with a maximum luminous intensity comprised between 33,750 cd and 45,000 cd (as indicated by the number 12.5), approved in Germany (E1) in accordance with the requirements of this Regulation in its original form (00), which is reciprocally incorporated with the same front position lamp as above;

Annex 3

**MEASURING SCREEN**  
 for Class A headlamps  
 (Dimensions in mm with screen at 25 m distance)

Figure A

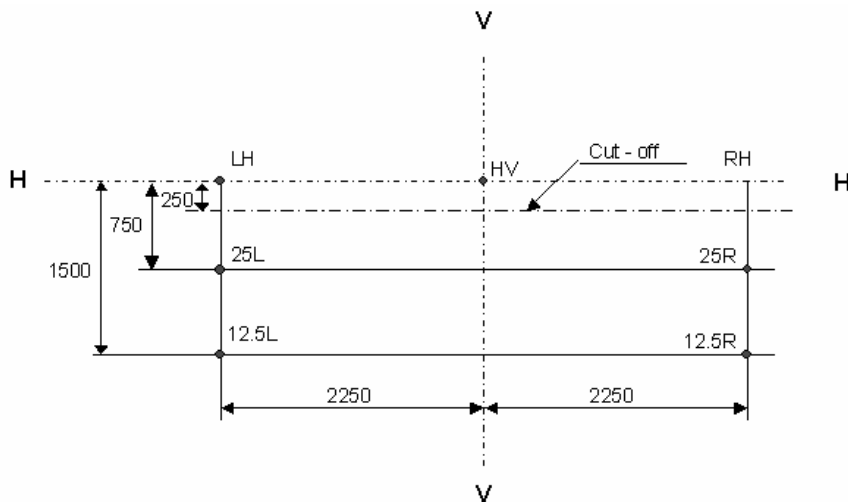

H-H: horizontal plane ) passing through  
 V-V: vertical plane ) focus of headlamp

**MEASURING SCREEN**  
 for Class B headlamps  
 (Dimensions in mm with screen at 25 m distance)

Figure B

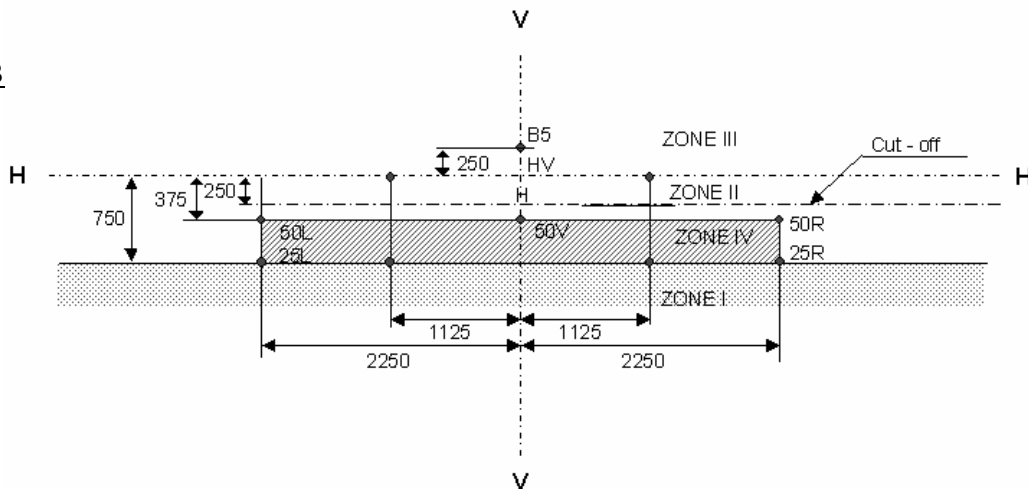

H-H: horizontal plane ) passing through  
 V-V: vertical plane ) focus of headlamp

MEASURING SCREEN  
for Class C, **D** and **E** headlamps  
(Dimensions in mm with screen at 25 m distance)

Figure C

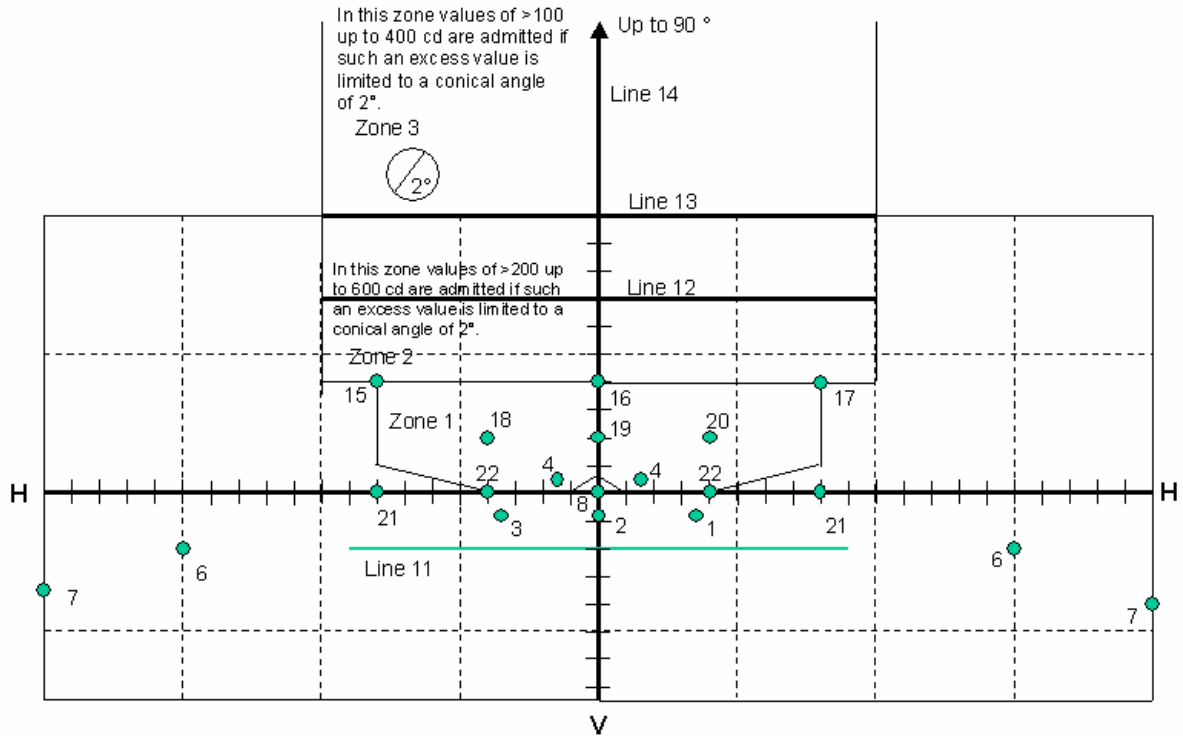

**Note:** The luminous intensity of zones 2 and 3 above are not applied to Class E.

Table A - Primary high beam headlamp

(Refer to figure D for details of test point positions)

Test point number	Test point location	Required illumination in lux					
		Class D		Class C		Class E	
		> 125cc		≤ 125cc			
		MIN	MAX	MIN	MAX	MIN	MAX
1	H-V <u>1/</u>	<u>1/</u>	---	<u>1/</u>	---	<u>1/</u>	---
2	H-3R and 3L	19.2	---	12.8	---	<b>30</b>	---
3	H-6R and 6L	6.4	---	4.16	---	<b>10</b>	---
4	H-9R and 9L	3.84	---	2.56	---	<b>6</b>	---
5	H-12R and 12L	1.28	---	0.8	---	<b>2</b>	---
6	2U-V	1.92	---	1.28	---	<b>3</b>	---
7	4D-V	---	<u>2/</u>	---	<u>2/</u>	---	<u>2/</u>
	MIN luminous intensity of the maximum	51.2	---	32	---	<b>70</b>	---
	MAX luminous intensity	---	180.0	---	180.0	---	<b>180.0</b>

1/ Intensity at H-V shall be equal to or greater than 80 per cent of the maximum intensity in the beam pattern.

2/ Intensity at **4D-V** shall be equal to or less than 30 per cent of the maximum intensity in the beam pattern.

Table B - Secondary high beam headlamp operated with a harmonized passing beam headlamp or a primary driving beam headlamp

(Refer to figure E for details of test point positions)

Test point number	Test point location	Required illumination in lux					
		Class D		Class C		Class E	
		> 125cc		≤ 125cc			
		MIN	MAX	MIN	MAX	MIN	MAX
1	H-V <u>1/</u>	<u>1/</u>	---	<u>1/</u>	---	<u>1/</u>	---
2	H-3R and 3L	19.2	---	12.8	---	<b>30</b>	---
3	H-6R and 6L	6.4	---	4.16	---	<b>10</b>	---
6	2U-V	1.92	---	1.28	---	<b>3</b>	---
7	4D-V	---	<u>2/</u>	---	<u>2/</u>	---	<u>2/</u>
	MIN luminous intensity of the maximum	51.2	---	32	---	<b>70</b>	---
	MAX luminous intensity	---	180.0	---	180.0	---	<b>180.0</b>

1/ Intensity at H-V shall be equal to or greater than 80 per cent of the maximum intensity in the beam pattern.

2/ Intensity at 4D-V shall be equal to or less than 30 per cent of the maximum intensity in the beam pattern.



Figure D  
Primary driving beam

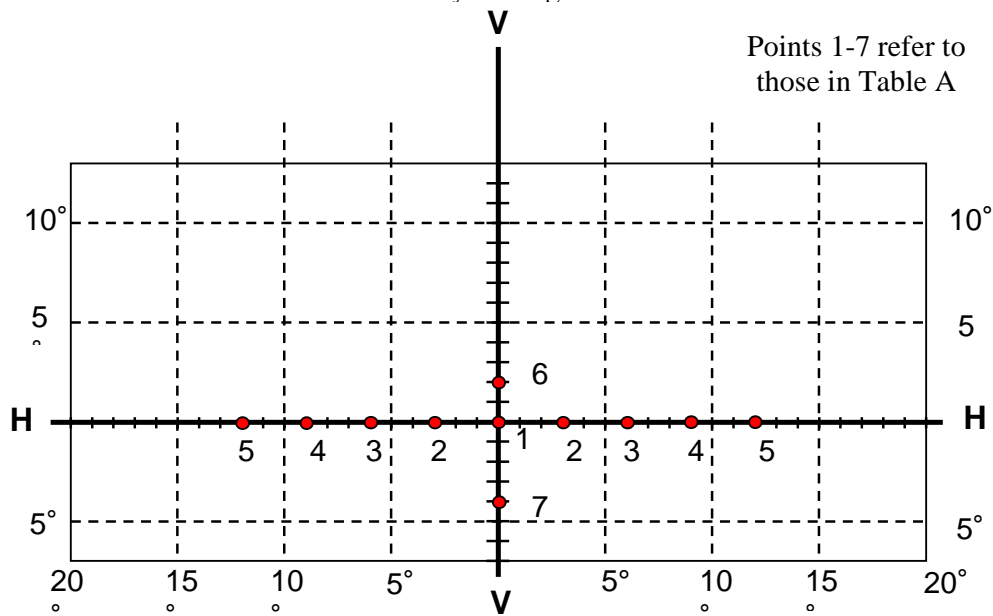
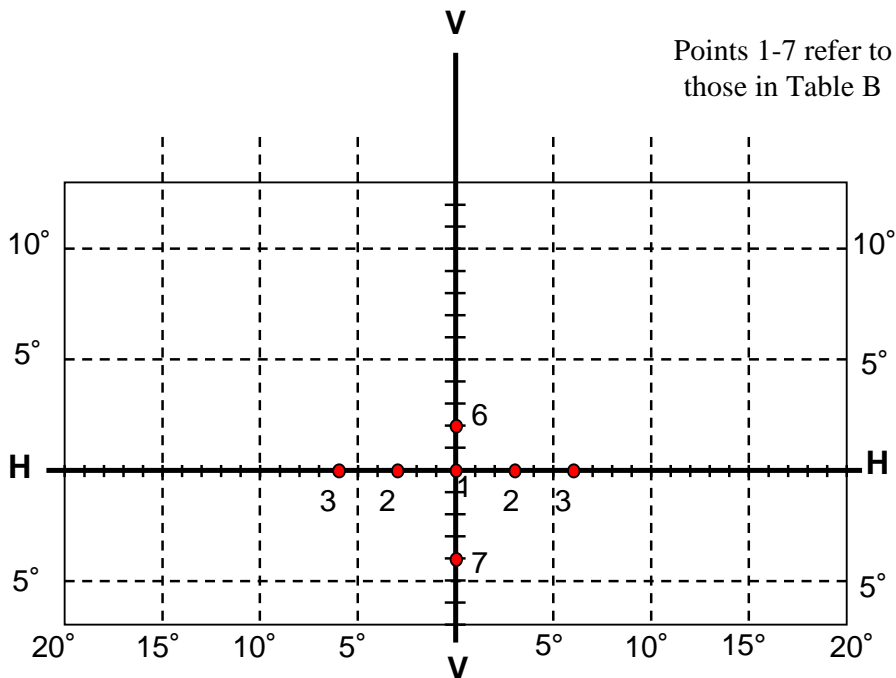

Figure E  
Secondary driving beam



Annex 4

TESTS FOR STABILITY OF PHOTOMETRIC PERFORMANCE OF HEADLAMPS IN OPERATION

TESTS ON COMPLETE CLASS B, C, **D AND E** HEADLAMPS

Once the photometric values have been measured according to the prescriptions of this Regulation, in the point for  $E_{max}$  for driving beam and in points HV, 50R, 50L and B50 **for Class B passing beam and in points 0.86D-3.5R, 0.86D-3.5L, 0.50U-1.5L, 0.50U-1.5R and HV for Class C, D and E**, for passing beam a complete headlamp sample shall be tested for stability of photometric performance in operation. "Complete headlamp" shall be understood to mean the complete lamp itself including those surrounding body parts and lamps which could influence its thermal dissipation.

1. TEST FOR STABILITY OF PHOTOMETRIC PERFORMANCE

The tests shall be carried out in a dry and still atmosphere at an ambient temperature of  $23^{\circ}\text{C} \pm 5^{\circ}\text{C}$ , the complete headlamp being mounted on a base representing the correct installation on the vehicle.

1.1. Clean headlamp

The headlamp shall be operated for 12 hours as described in paragraph 1.1.1. and checked as prescribed in paragraph 1.1.2.

1.1.1. Test procedure 1/

The headlamp shall be operated for a period according to the specified time, so that:

- 1.1.1.1. (a) In the case where only one lighting function (driving or passing beam or front fog lamp) is to be approved, the corresponding **light source** is lit for the prescribed time, 2/
- (b) In the case of a headlamp with a passing beam and one or more driving beams or in case of a headlamp with a passing beam and a front fog lamp:
- (i) the headlamp shall be subjected to the following cycle until the time specified is reached:
- a 15 minutes, **passing-beam** lit;
  - b 5 minutes, all **functions** lit.

---

1/ For the test schedule see Annex 8 to this Regulation.

2/ When the tested headlamp includes signalling lamps, the latter shall be lit for the duration of the test. In the case of a direction indicator lamp, it shall be lit in flashing mode with an on/off time of approximately one to one.

- (ii) if the applicant declares that the headlamp is to be used with only the passing beam lit or only the driving beam(s) lit 3/ at a time, the test shall be carried out in accordance with this condition, activating 2/ successively the passing beam half of the time and the driving beam(s) (simultaneously) for half the time specified in paragraph 1.1. above.
- (c) in the case of a headlamp with a front fog lamp and one or more driving beams:
  - (i) the headlamp shall be subjected to the following cycle until the time specified is reached:
    - a 15 minutes, front fog lamp lit;
    - b 5 minutes, all **functions** lit.
  - (ii) if the applicant declares that the headlamp is to be used with only the front fog lamp lit or only the driving beam(s) lit 3/ at a time, the test shall be carried out in accordance with this condition, activating 2/ successively the front fog lamp half of the time and the driving beam(s) (simultaneously) for half the time specified in paragraph 1.1. above.
- (d) In the case of headlamp with a passing beam, one or more driving beams and a front fog lamp:
  - (i) the headlamp shall be subjected to the following cycle until the time specified is reached:
    - a 15 minutes, **passing-beam** lit;
    - b 5 minutes, all **functions** lit.
  - (ii) if the applicant declares that the headlamp is to be used with only the passing beam lit or only the driving beam(s) 3/ lit at a time, the test shall be carried out in accordance with this condition, activating 2/ successively the passing beam half of the time and the driving beam(s) for half the time specified in paragraph 1.1. above, while the front fog lamp is subjected to a cycle of 15 minutes off and 5 minutes lit for half of the time and during the operation of the driving beam;
  - (iii) if the applicant declares that the headlamp is to be used with only the passing beam lit or only the front fog lamp 3/ lit at a time, the test shall be carried out in accordance with this condition, activating 2/ successively the passing beam half of the time and the front fog lamp for half of the time specified in paragraph 1.1. above, while the driving beam(s) is(are) subjected to a cycle of 15 minutes off and 5 minutes lit for half of the time and during the operation of the passing beam;

---

3/ Should two or more lamp **light source** be simultaneously lit when headlamp flashing is used, this shall not be considered as being normal use of the **light source** simultaneously.

- (iv) if the applicant declares that the headlamp is to be used with only the passing beam lit or only the driving beam(s) 3/ lit or only the front fog lamp 3/ lit at a time, the test shall be carried out in accordance with this condition, activating 2/ successively the passing beam one third of the time, the driving beam(s) one third of the time and the front fog lamp for one third of the time specified in paragraph 1.1. above.

1.1.1.2. Test voltage

**In the case of a Class B, C and D headlamp, the voltage shall be adjusted so as to supply 90 per cent of the maximum wattage specified in Regulation No. 37 for the filament lamp(s) used.**

The applied wattage shall in all cases comply with the corresponding value of a filament lamp of 12 V rated voltage, except if the applicant for approval specifies that the headlamp may be used at a different voltage.

**In the case of a Class E headlamp, the test voltage for the ballast is  $13.5 \pm 0.1$  Volts for 12 V network system, or otherwise specified in the application for approval. If there are reciprocally incorporated filament lamps, the voltage producing the reference flux shall be used.**

1.1.2. Test results

1.1.2.1. Visual inspection

Once the headlamp has been stabilized to the ambient temperature, the headlamp lens and the external lens, if any, shall be cleaned with a clean, damp cotton cloth. It shall then be inspected visually; no distortion, deformation, cracking or change in colour of either the headlamp lens or the external lens, if any, shall be noticeable.

1.1.2.2. Photometric test

To comply with the requirements of this Regulation, the photometric values shall be verified in the following points:

For Class B headlamp:

Passing beam: 50R - 50L - B50 - HV.

Driving beam: Point of  $E_{\max}$

For Class C, **D and E** headlamp:

Passing beam: 0.86D/3.5R - 0.86D/3.5L - 0.50U/1.5L and 1.5R - HV.

Driving beam: Point of  $E_{\max}$

Another aiming may be carried out to allow for any deformation of the headlamp base due to heat (the change of the position of the "cut-off" line is covered in paragraph 2. of this annex).

A 10 per cent discrepancy between the photometric characteristics and the values measured prior to the test is permissible including the tolerances of the photometric procedure.

## 1.2. Dirty headlamp

After being tested as specified in paragraph 1.1. above, the headlamp shall be operated for one hour as described in paragraph 1.1.1., after being prepared as prescribed in paragraph 1.2.1., and checked as prescribed in paragraph 1.1.2.

### 1.2.1. Preparations of the headlamp

#### 1.2.1.1. Test mixture

##### 1.2.1.1.1. For headlamp with the outside lens in glass:

The mixture of water and a polluting agent to be applied to the headlamp shall be composed of:

- (a) 9 parts by weight of silica sand with a particle size of 0-100  $\mu\text{m}$ ,
- (b) 1 part by weight of vegetal carbon dust (beechwood) with a particle size of 0-100  $\mu\text{m}$ ,
- (c) 0.2 parts by weight of NaCMC 4/, and
- (d) an appropriate quantity of distilled water, with a conductivity of  $\leq 1$  mS/m.

The mixture must not be more than 14 days old.

##### 1.2.1.1.2. For headlamp with outside lens in plastic material:

The mixture of water and polluting agent to be applied to the headlamp shall be composed of:

- (a) 9 parts by weight of silica sand with a particle size of 0-100  $\mu\text{m}$ ,
- (b) 1 part by weight of vegetal carbon dust (beechwood) with a particle size of 0-100  $\mu\text{m}$ ,
- (c) 0.2 part by weight of NaCMC 4/,
- (d) 13 parts by weight of distilled water with a conductivity of  $\leq 1$  mS/m, and
- (e)  $2 \pm 1$  parts by weight of surface-actant 5/.

---

4/ NaCMC represents the sodium salt of carboxymethylcellulose, customarily referred to as CMC. The NaCMC used in the dirt mixture shall have a degree of substitution (DS) of 0.6 - 0.7 and a viscosity of 0.2 – 0.3 Pa · s for a 2 per cent solution at 20 °C.

5/ The tolerance on quantity is due to the necessity of obtaining a dirt that correctly spreads out on all the plastic lens.

The mixture must not be more than 14 days old.

1.2.1.2. Application of the test mixture to the headlamp

The test mixture shall be uniformly applied to the entire light-emitting surface of the headlamp and then left to dry.

This procedure shall be repeated until the illumination value has dropped to 15-20 per cent of the values measured for each following point under the conditions described in this annex:

For Class B headlamp:

Passing beam/driving beam and driving beam only: Point of  $E_{\max}$

Passing beam only: B 50 and 50 V

For Class C, **D and E** headlamp:

Passing beam/driving beam and driving beam only: Point of  $E_{\max}$

Passing beam only: 0.50U/1.5L and 1.5R and 0.86D/V

1.2.1.3. Measuring equipment

The measuring equipment shall be equivalent to that used during headlamp approval tests. A standard (étalon) filament lamp **or gas-discharge light source supplied by the applicant** shall be used for the photometric verification.

2. TEST FOR CHANGE IN VERTICAL POSITION OF THE "CUT-OFF" LINE UNDER THE INFLUENCE OF HEAT

This test consists of verifying that the vertical drift of the "cut-off" line under the influence of heat does not exceed a specified value for an operating passing lamp.

The headlamp tested in accordance with paragraph 1., shall be subjected to the test described in paragraph 2.1., without being removed from or readjusted in relation to its test fixture.

2.1. Test

The test shall be carried out in a dry and still atmosphere at an ambient temperature of  $23^{\circ}\text{C} \pm 5^{\circ}\text{C}$ .

Using a mass production filament lamp which has been aged for at least one hour **or a mass production gas-discharge light source which has been aged for at least 15 hours**, the headlamp shall be operated on passing beam without being dismantled from or readjusted in relation to its test fixture. (For the purpose of this test, the voltage shall be adjusted as specified in paragraph 1.1.1.2.). The position of

the "cut-off" line in its horizontal part (between the vertical lines passing through point 50 L and 50 R for Class B headlamp, 3.5 L and 3.5 R for Class C, **D and E** headlamp) shall be verified 3 minutes ( $r_3$ ) and 60 minutes ( $r_{60}$ ) respectively after operation.

The measurement of the variation in the "cut-off" line position as described above shall be carried out by any method giving acceptable accuracy and reproducible results.

## 2.2. Test results

2.2.1. The result in milliradians (mrad) shall be considered as acceptable for a passing lamp, only when the absolute value  $\Delta r_I = |r_3 - r_{60}|$  recorded on the headlamp is not more than 1.0 mrad ( $\Delta r_I \leq 1.0$  mrad).

2.2.2. However, if this value is more than 1.0 mrad but not more than 1.5 mrad ( $1.0 \text{ mrad} < \Delta r_I \leq 1.5 \text{ mrad}$ ) a second headlamp shall be tested as described in paragraph 2.1. after being subjected three consecutive times to the cycle as described below, in order to stabilize the position of mechanical parts of the headlamp on a base representative of the correct installation on the vehicle:

Operation of the passing beam for one hour, (the voltage shall be adjusted as specified in paragraph 1.1.1.2.),

Period of rest for one hour.

The headlamp type shall be considered as acceptable if the mean value of the absolute values  $\Delta r_I$  measured on the first sample and  $\Delta r_{II}$  measured on the second sample is not more than 1.0 mrad.

Annex 5

MINIMUM REQUIREMENTS FOR CONFORMITY OF PRODUCTION CONTROL  
PROCEDURES

1. GENERAL
  - 1.1. The conformity requirements shall be considered satisfied from a mechanical and a geometrical standpoint, if the differences do not exceed inevitable manufacturing deviations within the requirements of this Regulation. This condition also applies to colour.
  - 1.2. **For Class A, B, C and D headlamp:**
    - 1.2.1. With respect to photometric performances, the conformity of mass-produced headlamps shall not be contested if, when testing photometric performances of any headlamp chosen at random and equipped with a standard filament lamp.
    - 1.2.2. Class A headlamp: no measured value deviates unfavourably by more than 20 per cent from the value prescribed in this Regulation.
    - 1.2.3. Class B, C and D headlamp:
      - 1.2.3.1. no measured value deviates unfavourably by more than 20 per cent from the value prescribed in this Regulation. For values in zone III, for Class B headlamp, zone 1 for Class C and D headlamp, the maximum unfavourable deviation may be respectively:  
  
0.3 lux equivalent 20 per cent  
0.45 lux equivalent 30 per cent
      - 1.2.3.2. and if, for the driving beam, HV being situated within the isolux  $0.75 E_{\max}$ , a tolerance of + 20 per cent for maximum values and - 20 per cent for minimum values is observed for the photometric values at any measuring point specified in paragraphs 6.2.3.2. and 6.3.2.2. of this Regulation.
    - 1.2.4. If the results of the tests described above do not meet the requirements, tests shall be repeated using another standard filament lamp.
  - 1.3. **For Class E headlamp:**
    - 1.3.1. **With respect to photometric performance, the conformity of mass-produced headlamps shall not be contested when testing photometric performance of any headlamp chosen at random and measured at  $13.5 \text{ V} \pm 0.1 \text{ V}$  or as otherwise specified if**



either equipped with a removable standard gas-discharge light source. The luminous flux of this gas-discharge light source may differ from the reference luminous flux specified in Regulation No. 99. In this case, the illuminances shall be corrected accordingly; or

equipped with the serial production gas-discharge light source and the serial ballast. The luminous flux of this light source may deviate from the nominal luminous flux due to light source and ballast tolerances as specified in Regulation No. 99; accordingly the measured illuminances may be corrected by 20 per cent in the favourable direction.

- 1.3.2. no measured value deviates unfavourably by more than 20 per cent from the value prescribed in this Regulation. For values in zone 1, the maximum unfavourable deviation may be respectively:

0.3 lux equivalent 20 per cent

0.45 lux equivalent 30 per cent

- 1.3.3. and if, for the driving beam, HV being situated within the isolux  $0.75 E_{\max}$ , a tolerance of + 20 per cent for maximum values and - 20 per cent for minimum values is observed for the photometric values at any measuring point specified in paragraphs 6.3.2.1. and 6.3.2.2. of this Regulation

- 1.3.4. If the results of the tests described above do not meet the requirements, the alignment of the headlamp may be changed, provided that the axis of the beam is not displaced laterally by more than 0.5 degrees to the right or left and not by more than 0.2 degrees up or down.

- 1.3.5. If the results of the tests described above do not meet the requirements, tests on the headlamp shall be repeated using another standard gas-discharge light source or gas-discharge light source and ballast, whatever is applicable according to paragraph 1.3.1. above.

- 1.4. With respect to the verification of the change in vertical position of the "cut-off" line under the influence of heat, the following procedure shall be applied (Class B, C, D and E headlamps only):

One of the sampled headlamps shall be tested according to the procedure described in paragraph 2.1. of Annex 4 after being subjected three consecutive times to the cycle described in paragraph 2.2.2. of Annex 4.

The headlamp shall be considered as acceptable if  $\Delta r$  does not exceed 1.5 mrad.

If this value exceeds 1.5 mrad but is not more than 2.0 mrad, a second sample shall be subjected to the test after which the mean of the absolute values recorded on both samples shall not exceed 1.5 mrad.

**1.5.** Headlamps with apparent defects are disregarded.

**1.6.** If, however, for a series of samples vertical adjustment cannot be performed repeatedly to the required position within the allowed tolerances, the quality of "cut-off" shall be tested on one of the headlamps from the series of samples, according to the procedure described in Annex 9, paragraphs 2. and 4.

## **2. MINIMUM REQUIREMENTS FOR VERIFICATION OF CONFORMITY BY THE MANUFACTURER**

For each type of headlamp the holder of the approval mark shall carry out at least the following tests, at appropriate intervals. The tests shall be carried out in accordance with the provision of this Regulation.

If any sampling shows non-conformity with regard to the type of test concerned, further samples shall be taken and tested. The manufacturer shall take steps to ensure the conformity of the production concerned.

### **2.1. Nature of tests**

Tests of conformity in this Regulation shall cover the photometric characteristics and for Class B, C, **D and E** headlamps the verification of the change in vertical position of the "cut-off" line under influence of heat.

### **2.2. Methods used in tests**

**2.2.1.** Tests shall generally be carried out in accordance with the methods set out in this Regulation.

**2.2.2.** In any test of conformity carried out by the manufacturer, equivalent methods may be used with the consent of the competent authority responsible for approval tests. The manufacturer is responsible for proving that the applied methods are equivalent to those laid down in this Regulation.

**2.2.3.** The application of paragraphs 2.2.1. and 2.2.2. requires regular calibration of test apparatus and its correlation with measurement made by a competent authority.

**2.2.4.** In all cases the reference methods shall be those of this Regulation, particular for the purpose of administrative verification and sampling.

2.3. Nature of sampling

Samples of headlamps shall be selected at random from the production of a uniform batch. A uniform batch means a set of headlamps of the same type, defined according to the production methods of the manufacturer.

The assessment shall in general cover series production from individual factories. However, a manufacturer may group together records concerning the same type from several factories provided these operate under the same quality system and quality management.

2.4. Measured and recorded photometric characteristics

The sampled headlamps shall be subjected to photometric measurements at the points provided for in the Regulation, the reading being limited at the points:

2.4.1. For Class A headlamps: HV, LH, RH, 12.5L and 12.5R

2.4.2. For Class B headlamps:  $E_{\max}$ , HV 1/, in the case of the driving beam, and to the points HV, 50R, 50L, in the case of the passing beam.

2.4.3. For Class C, **D and E** headlamps:  $E_{\max}$ , HV 1/, in the case of the driving beam, and to the points HV, 0.86D/3.5R, 0.86D/3.5L, in the case of the passing beam.

2.5. Criteria governing acceptability

The manufacturer is responsible for carrying out a statistical study of the test results and for defining, in agreement with the competent authority, criteria governing acceptability of his products in order to meet the specification laid down for verification of conformity of products in paragraph 9.1. of this Regulation.

The criteria governing acceptability shall be such that, with a confidence level of 95 per cent, the minimum probability of passing a spot check in accordance with Annex 7 (first sampling) would be 0.95.

---

1/ When the driving beam is reciprocally incorporated with the passing beam, HV in the case of the driving beam shall be the same measuring point as in the case of the passing beam.

Annex 6

REQUIREMENTS FOR LAMPS INCORPORATING LENSES OF PLASTIC MATERIAL -  
TESTING OF LENS OR MATERIAL SAMPLES AND OF COMPLETE LAMPS

1. GENERAL SPECIFICATIONS

- 1.1. The samples supplied pursuant to paragraph 2.2.4. of this Regulation shall satisfy the specifications indicated in paragraphs 2.1. to 2.5. below.
- 1.2. The two samples of complete lamps supplied pursuant to paragraph 2.2.3. of this Regulation and incorporating lenses of plastic material shall, with regard to the lens material, satisfy the specifications indicated in paragraph 2.6. below.
- 1.3. The samples of lenses of plastic material or samples of material shall be subjected, with the reflector to which they are intended to be fitted (where applicable), to approval tests in the chronological order indicated in table A reproduced in Appendix 1 to this annex.
- 1.4. However, if the lamp manufacturer can prove that the product has already passed the tests prescribed in paragraphs 2.1. to 2.5. below, or the equivalent tests pursuant to another Regulation, those tests need not be repeated; only the tests prescribed in Appendix 1, table B, shall be mandatory.

2. TESTS

2.1. Resistance to temperature changes

2.1.1. Tests

Three new samples (lenses) shall be subjected to five cycles of temperature and humidity (RH = relative humidity) change in accordance with the following programme:

- (a) 3 hours at  $40\text{ °C} \pm 2\text{ °C}$  and 85-95 per cent RH;
- (b) 1 hour at  $23\text{ °C} \pm 5\text{ °C}$  and 60-75 per cent RH;
- (c) 15 hours at  $-30\text{ °C} \pm 2\text{ °C}$ ;
- (d) 1 hour at  $23\text{ °C} \pm 5\text{ °C}$  and 60-75 per cent RH;
- (e) 3 hours at  $80\text{ °C} \pm 2\text{ °C}$ ;
- (f) 1 hour at  $23\text{ °C} \pm 5\text{ °C}$  and 60-75 per cent RH;

Before this test, the samples shall be kept at  $23\text{ °C} \pm 5\text{ °C}$  and 60-75 per cent RH for at least four hours.

Note: The periods of one hour at  $23\text{ °C} \pm 5\text{ °C}$  shall include the periods of transition from one temperature to another which are needed in order to avoid thermal shock effects.

2.1.2. Photometric measurements

2.1.2.1. Method

Photometric measurements shall be carried out on the samples before and after the test.

These measurements shall be made using a standard (étalon) lamp, **or standard gas-discharge light source**, at the following points:

B 50, 50L and 50R for Class B headlamp, 0.86D/3.5R, 0.86D/3.5L, 0.50U/1.5L and 1.5R for Class C, **D and E** headlamp for the passing beam or a passing/driving lamp;

$E_{\max}$  for the driving beam of a driving lamp or a passing/driving lamp;

2.1.2.2. Results

The variation between the photometric values measured on each sample before and after the test shall not exceed 10 per cent including the tolerances of the photometric procedure.

2.2. Resistance to atmospheric and chemical agents

2.2.1. Resistance to atmospheric agents

Three new samples (lenses or samples of material) shall be exposed to radiation from a source having a spectral energy distribution similar to that of a black body at a temperature between 5,500 K and 6,000 K. Appropriate filters shall be placed between the source and the samples so as to reduce as far as possible radiations with wave lengths smaller than 295 nm and greater than 2,500 nm. The samples shall be exposed to an energetic illumination of  $1,200\text{ W/m}^2 \pm 200\text{ W/m}^2$  for a period such that the luminous energy that they receive is equal to  $4,500\text{ MJ/m}^2 \pm 200\text{ MJ/m}^2$ . Within the enclosure, the temperature measured on the black panel placed on a level with the samples shall be  $50\text{ °C} \pm 5\text{ °C}$ . In order to ensure a regular exposure, the samples shall revolve around the source of radiation at a speed between 1 and  $5\text{ min}^{-1}$ .

The samples shall be sprayed with distilled water of conductivity lower than 1 mS/m at a temperature of  $23\text{ °C} \pm 5\text{ °C}$ , in accordance with the following cycle:

spraying: 5 minutes; drying: 25 minutes.

## 2.2.2. Resistance to chemical agents

After the test described in paragraph 2.2.1. above and the measurement described in paragraph 2.2.3.1. below have been carried out, the outer face of the said three samples shall be treated as described in paragraph 2.2.2.2. with the mixture defined in paragraph 2.2.2.1. below.

### 2.2.2.1 Test mixture

The test mixture shall be composed of 61.5 per cent n-heptane, 12.5 per cent toluene, 7.5 per cent ethyl tetrachloride, 2.5 per cent trichloroethylene and 6 per cent xylene (volume per cent).

### 2.2.2.2. Application of the test mixture

Soak a piece of cotton cloth (as specified in ISO 105) until saturation with the mixture defined in paragraph 2.2.2.1. above and, within 10 seconds, apply it for 10 minutes to the outer face of the sample at a pressure of  $50\text{ N/cm}^2$ , corresponding to an effort of 100 N applied on a test surface of 14 x 14 mm.

During this 10-minute period, the cloth pad shall be soaked again with the mixture so that the composition of the liquid applied is continuously identical with that of the test mixture prescribed.

During the period of application, it is permissible to compensate the pressure applied to the sample in order to prevent it from causing cracks.

### 2.2.2.3. Cleaning

At the end of the application of the test mixture, the samples shall be dried in the open air and then washed with the solution described in paragraph 2.3. (resistance to detergents)  $23\text{ °C} \pm 5\text{ °C}$ .

Afterwards the samples shall be carefully rinsed with distilled water containing not more than 0.2 per cent impurities at  $23\text{ °C} \pm 5\text{ °C}$  and then wiped off with a soft cloth.

2.2.3. Results

2.2.3.1. After the test of resistance to atmospheric agents, the outer face of the samples shall be free from cracks, scratches, chipping and deformation, and the mean variation in transmission  $\Delta t = \frac{T_2 - T_3}{T_2}$ , measured on the three samples according to the procedure described in Appendix 2 to this annex shall not exceed 0.020 ( $\Delta t_m < 0.020$ ).

2.2.3.2. After the test of resistance to chemical agents, the samples shall not bear any traces of chemical staining likely to cause a variation of flux diffusion, whose mean variation  $\Delta t = \frac{T_5 - T_4}{T_2}$ , measured on the three samples according to the procedure described in Appendix 2 to this annex shall not exceed 0.020 ( $\Delta t_m \leq 0.020$ ).

2.3. Resistance to detergents and hydrocarbons

2.3.1. Resistance to detergents

The outer face of three samples (lenses or samples of material) shall be heated to  $50\text{ °C} \pm 5\text{ °C}$  and then immersed for five minutes in a mixture maintained at  $23\text{ °C} \pm 5\text{ °C}$  and composed of 99 parts distilled water containing not more than 0.02 per cent impurities and one part alkylaryl sulphonate.

At the end of the test, the samples shall be dried at  $50\text{ °C} \pm 5\text{ °C}$ .

The surface of the samples shall be cleaned with a moist cloth.

2.3.2. Resistance to hydrocarbons

The outer face of these three samples shall then be lightly rubbed for one minute with a cotton cloth soaked in a mixture composed of 70 per cent n-heptane and 30 per cent toluene (volume per cent), and shall then be dried in the open air.

2.3.3. Results

After the above two tests have been performed successively, the mean value of the variation in transmission  $\Delta t = \frac{T_2 - T_3}{T_2}$ , measured on the three samples according to the procedure described in Appendix 2 to this annex shall not exceed 0.010 ( $\Delta t_m \leq 0.010$ ).

## 2.4. Resistance to mechanical deterioration

### 2.4.1. Mechanical deterioration method

The outer face of the three new samples (lenses) shall be subjected to the uniform mechanical deterioration test by the method described in Appendix 3 to this annex.

### 2.4.2. Results

After this test, the variations:

in transmission:  $\Delta t = \frac{T_2 - T_3}{T_2}$ ,

and in diffusion:  $\Delta t = \frac{T_5 - T_4}{T_2}$ ,

shall be measured according to the procedure described in Appendix 2 in the area specified in paragraph 2.2.4.1.1. of this Regulation. The mean value of the three samples shall be such that:

$$\Delta t_m \leq 0.100;$$

$$\Delta d_m \leq 0.050$$

## 2.5. Test of adherence of coatings, if any

### 2.5.1. Preparation of the sample

A surface of 20 mm x 20 mm in area of the coating of a lens shall be cut with a razor blade or a needle into a grid of squares approximately 2 mm x 2 mm. The pressure on the blade or needle shall be sufficient to cut at least the coating.

### 2.5.2. Description of the test

Use an adhesive tape with a force adhesion of 2 N/(cm of width)  $\pm$  20 per cent measured under the standardized conditions specified in Appendix 4 to this annex. This adhesive tape, which shall be at least 25 mm wide, shall be pressed for at least five minutes to the surface prepared as prescribed in paragraph 2.5.1.

Then the end of the adhesive tape shall be loaded in such a way that the force of adhesion to the surface considered is balanced by a force perpendicular to that surface. At this stage, the tape shall be torn off at a constant speed of 1.5 m/s  $\pm$  0.2 m/s.



2.5.3. Results

There shall be no appreciable impairment of the gridded area. Impairments at the intersections between squares or at the edges of the cuts shall be permitted, provided that the impaired area does not exceed 15 per cent of the gridded surface.

**2.5.4. Resistance to light source radiations for Class E**

**The following test shall be done:**

**Flat samples of each light transmitting plastic component of the headlamp are exposed to the light of the gas-discharge light source. The parameters such as angles and distances of these samples shall be the same as in the headlamp. These samples shall have the same colour and surface treatment, if any, as the parts of the headlamp.**

**After 1,500 hours of continuous exposure, the colorimetric specifications of the transmitted light must be met with a new standard gas-discharge light source, and the surfaces of the samples shall be free of cracks, scratches, scalings or deformation.**

2.6. Tests of the complete headlamp incorporating a lens of plastic material

2.6.1. Resistance to mechanical deterioration of the lens surface

2.6.1.1. Tests

The lens of lamp sample No. 1 shall be subjected to the test described in paragraph 2.4.1. above.

2.6.1.2. Results

After the test, the results of photometric measurements carried out on the headlamp in accordance with this Regulation shall not exceed by more than 30 per cent the maximum values prescribed at point HV and not be more than 10 per cent below the minimum values prescribed at point 50 L and 50 R for Class B headlamp, 0.86D/3.5R, 0.86D/3.5L for Class C, D and E headlamp.

2.6.2. Test of adherence of coatings, if any

The lens of lamp sample No. 2 shall be subjected to the test described in paragraph 2.5. above.

3. VERIFICATION OF THE CONFORMITY OF PRODUCTION

3.1. With regard to the materials used for the manufacture of lenses, the lamps of a series shall be recognized as complying with this Regulation if:

3.1.1. after the test for resistance to chemical agents and the test for resistance to detergents and hydrocarbons, the outer face of the samples exhibits no cracks, chipping or deformation visible to the naked eye (see paragraphs 2.2.2., 2.3.1. and 2.3.2.);

3.1.2. after the test described in paragraph 2.6.1.1., the photometric values at the points of measurement considered in paragraph 2.6.1.2. are within the limits prescribed for conformity of production by this Regulation.

3.2. If the test results fail to satisfy the requirements, the tests shall be repeated on another sample of headlamps selected at random.

Annex 6 - Appendix 1

CHRONOLOGICAL ORDER OF APPROVAL TESTS

A. Tests on plastic materials (lenses or samples of material supplied pursuant to paragraph 2.2.4. of this Regulation).

Tests \ Samples	Lenses or samples of material							Lenses						
	1	2	3	4	5	6	7	8	9	10	11	12	13	14
1.1. Limited photometry (para. 2.1.2.)											X	X	X	
1.1.1. Temperature change (para. 2.1.1.)											X	X	X	
1.1.2. Limited photometry (para. 2.1.2.)											X	X	X	
1.2.1. Transmission measurement	X	X	X	X	X	X		X	X	X				
1.2.2. Diffusion measurement	X	X	X					X	X	X				
1.3. Atmospheric agents (para. 2.2.1.)	X	X	X											
1.3.1. Transmission measurement	X	X	X											
1.4. Chemical agents (para. 2.2.2.)	X	X	X											
1.4.1. Diffusion measurement	X	X	X											
1.5. Detergents (para. 2.3.1.)				X	X	X								
1.6. Hydrocarbons (para. 2.3.2.)				X	X	X								
1.6.1. Transmission measurement				X	X	X								
1.7. Deterioration (para. 2.4.1.)								X	X	X				
1.7.1. Transmission measurement								X	X	X				
1.7.2. Diffusion measurement								X	X	X				
1.8. Adherence (para. 2.5.)														X
<b>1.9. Resistance to light source radiations (para. 2.5.4.)</b>							X							

B. Tests on complete headlamps (supplied pursuant to paragraph 2.2.3. of this Regulation).

Tests	Complete headlamp	
	Sample No.	
	1	2
2.1. Deterioration (para. 2.6.1.1.)	x	
2.2. Photometry (para. 2.6.1.2.)	x	
2.3. Adherence (para. 2.6.2.)		x

Annex 6 - Appendix 2

METHOD OF MEASUREMENT OF THE DIFFUSION AND TRANSMISSION OF LIGHT

1. EQUIPMENT (see figure)

The beam of a collimator K with a half divergence  $\beta/2 = 17.4 \times 10^4$  rd is limited by a diaphragm D $\tau$  with an opening of 6 mm against which the sample stand is placed.

A convergent achromatic lens L<sub>2</sub>, corrected for spherical aberrations links the diaphragm D $\tau$  with the receiver R; the diameter of the lens L<sub>2</sub> shall be such that it does not diaphragm the light diffused by the sample in a cone with a half top angle of  $\beta/2 = 14^\circ$ .

An annular diaphragm D<sub>D</sub>, with angles  $\alpha_o/2 = 1^\circ$  and  $\alpha_{max}/2 = 12^\circ$  is placed in an image focal plane of the lens L<sub>2</sub>.

The non-transparent central part of the diaphragm is necessary in order to eliminate the light arriving directly from the light source. It shall be possible to remove the central part of the diaphragm from the light beam in such a manner that it returns exactly to its original position.

The distance L<sub>2</sub> D $\tau$  and the focal length F<sub>2</sub> 1/ of the lens L<sub>2</sub> shall be so chosen that the image of D $\tau$  completely covers the receiver R.

When the initial incident flux is referred to 1,000 units, the absolute precision of each reading shall be better than 1 unit.

2. MEASUREMENTS

The following readings shall be taken:

Reading	With sample	With central part of D <sub>D</sub>	Quantity represented
T <sub>1</sub>	no	no	Incident flux in initial reading
T <sub>2</sub>	yes (before test)	no	Flux transmitted by the new material in a field of 24°
T <sub>3</sub>	yes (after test)	no	Flux transmitted by the tested material in a field of 24°
T <sub>4</sub>	yes (before test)	yes	Flux diffused by the new material
T <sub>5</sub>	yes (after test)	yes	Flux diffused by the tested material

1/ For L<sub>2</sub> it is recommended to use a focal distance of about 80 mm.

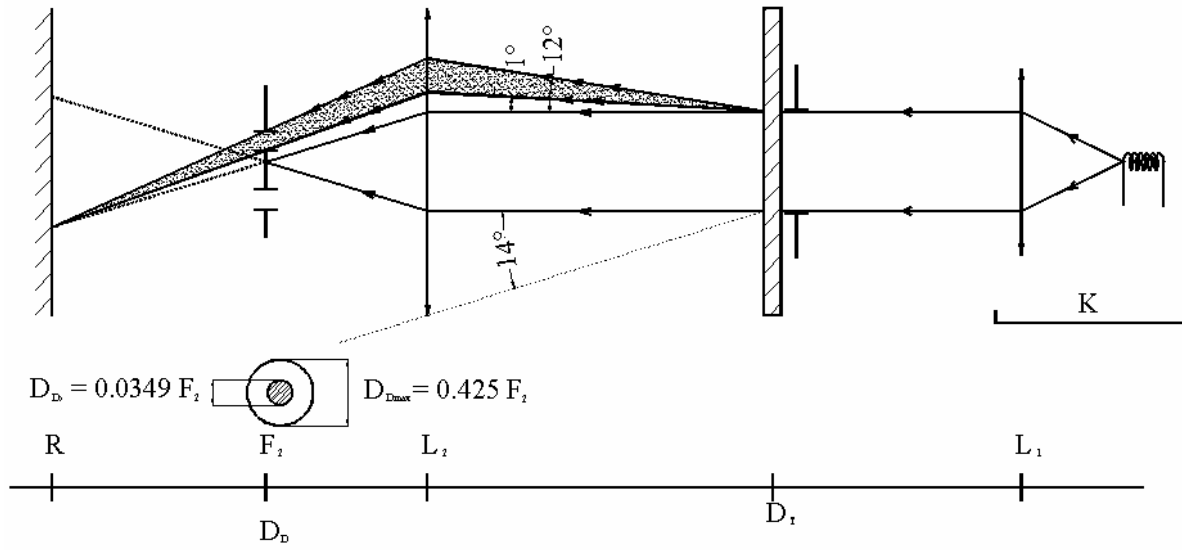

Annex 6 - Appendix 3

SPRAY TESTING METHOD

1. TEST EQUIPMENT

1.1. Spray gun

The spray gun used shall be equipped with a nozzle 1.3 mm in diameter allowing a liquid flow rate of  $0.24 \pm 0.02$  l/minute at an operating pressure of 6.0 bars  $-0/+0.5$  bar.

Under these operation conditions the fan pattern obtained shall be  $170 \text{ mm} \pm 50 \text{ mm}$  in diameter on the surface exposed to deterioration, at a distance of  $380 \text{ mm} \pm 10 \text{ mm}$  from the nozzle.

1.2. Test mixture

The test mixture shall be composed of:

Silica sand of hardness 7 on the Mohr scale, with a grain size between 0 and 0.2 mm and an almost normal distribution, with an angular factor of 1.8 to 2;

Water of hardness not exceeding  $205 \text{ g/m}^3$  for a mixture comprising 25 g of sand per litre of water.

2. TEST

The outer surface of the lamp lenses shall be subjected once or more than once to the action of the sand jet produced as described above. The jet shall be sprayed almost perpendicular to the surface to be tested.

The deterioration shall be checked by means of one or more samples of glass placed as a reference near the lenses to be tested. The mixture shall be sprayed until the variation in the diffusion of light on the sample or samples measured by the method described in Appendix 2, is such that:

$$\Delta d = \frac{T_5 - T_4}{T_2} = 0.0250 \pm 0.0025$$

Several reference samples may be used to check that the whole surface to be tested has deteriorated homogeneously.

Annex 6 - Appendix 4

ADHESIVE TAPE ADHERENCE TEST

1. PURPOSE

This method allows to determine under standard conditions the linear force of adhesion of an adhesive tape to a glass plate.

2. PRINCIPLE

Measurement of the force necessary to unstick an adhesive tape from a glass plate at an angle of 90°.

3. SPECIFIED ATMOSPHERIC CONDITIONS

The ambient conditions shall be at  $23\text{ °C} \pm 5\text{ °C}$  and  $65 \pm 15$  per cent RH.

4. TEST PIECES

Before the test, the sample roll of adhesive tape shall be conditioned for 24 hours in the specified atmosphere (see paragraph 3. above).

Five test pieces each 400 mm long shall be tested from each roll. These test pieces shall be taken from the roll after the first three turns were discarded.

5. PROCEDURE

The test shall be under the ambient conditions specified in paragraph 3.

Take the five test pieces while unrolling the tape radially at a speed of approximately 300 mm/s, then apply them within 15 seconds in the following manner:

Apply the tape to the glass plate progressively with a slight length-wise rubbing movement of the finger, without excessive pressure, in such a manner as to leave no air bubble between the tape and the glass plate.

Leave the assembly in the specified atmospheric conditions for 10 minutes.

Unstick about 25 mm of the test piece from the plate in a plane perpendicular to the axis of the test piece. Fix the plate and fold back the free end of the tape at 90°. Apply force in such a manner that the separation line between the tape and the plate is perpendicular to this force and perpendicular to the plate.

Pull to unstick at a speed of  $300\text{ mm/s} \pm 30\text{ mm/s}$  and record the force required.



## 6. RESULTS

The five values obtained shall be arranged in order and the median value taken as a result of the measurement. This value shall be expressed in Newtons per centimetre of width of the tape.

### Annex 7

## MINIMUM REQUIREMENTS FOR SAMPLING BY AN INSPECTOR

### 1. GENERAL

1.1. The conformity requirements shall be considered satisfied from a mechanical and a geometrical standpoint in accordance with the requirements of this Regulation, if any, if the differences do not exceed inevitable manufacturing deviations. This condition also applies to colour.

### 1.2. For Class A, B, C and D headlamp:

1.2.1. With respect to photometric performances, the conformity of mass-produced headlamps shall not be contested if, when testing photometric performances of any headlamp chosen at random and equipped with a standard filament lamp:

1.2.2. Class A headlamps: no measured value deviates unfavourably by more than 20 per cent from the value prescribed in this Regulation.

1.2.3. Class B, C and D headlamps:

1.2.3.1. no measured value deviates unfavourably by more than 20 per cent from the value prescribed in this Regulation. For values in zone III for Class B headlamp, zone I for Class C and D headlamp, the maximum unfavourable deviation may be respectively:

0.3 lux equivalent 20 per cent  
0.45 lux equivalent 30 per cent

1.2.3.2. and if for the driving beam, HV being situated within the isolux  $0.75 E_{\max}$ , a tolerance of + 20 per cent for maximum values and - 20 per cent for minimum values is observed for the photometric values at any measuring point specified in paragraphs 6.2.3.2. and 6.3.2.2. of this Regulation.

1.2.4. If the results of the tests described above do not meet the requirements, tests shall be repeated using another standard filament lamp.

### 1.3. For Class E headlamp:

1.3.1. **With respect to photometric performance, the conformity of mass-produced headlamps shall not be contested when testing photometric performance of any**

**headlamp chosen at random and measured at  $13.5\text{ V} \pm 0.1\text{ V}$  or as otherwise specified if**

**either equipped with a removable standard gas-discharge light source. The luminous flux of this gas-discharge light source may differ from the reference luminous flux specified in Regulation No. 99. In this case, the illuminances shall be corrected accordingly; or**

**equipped with the serial production gas-discharge light source and the serial ballast. The luminous flux of this light source may deviate from the nominal luminous flux due to light source and ballast tolerances as specified in Regulation No. 99; accordingly the measured illuminances may be corrected by 20 per cent in the favourable direction.**

**1.3.2. no measured value deviates unfavourably by more than 20 per cent from the value prescribed in this Regulation. For values in zone 1, the maximum unfavourable deviation may be respectively:**

**0.3 lux equivalent 20 per cent**

**0.45 lux equivalent 30 per cent**

**1.3.3. and if, for the driving beam, HV being situated within the isolux  $0.75 E_{\max}$ , a tolerance of + 20 per cent for maximum values and - 20 per cent for minimum values is observed for the photometric values at any measuring point specified in paragraphs 6.3.2.1. and 6.3.2.2. of this Regulation**

**1.3.4. If the results of the tests described above do not meet the requirements, the alignment of the headlamp may be changed, provided that the axis of the beam is not displaced laterally by more than 0.5 degrees to the right or left and not by more than 0.2 degrees up or down.**

**1.3.5. If the results of the tests described above do not meet the requirements, tests on the headlamp shall be repeated using another standard gas-discharge light source or gas-discharge light source and ballast, whatever is applicable according to paragraph 1.3.1. above.**

**1.4. Headlamps with apparent defects are disregarded.**

**1.5. If, however, for a series of samples vertical adjustment cannot be performed repeatedly to the required position within the allowed tolerances, the quality of "cut-off" shall be tested on one of the headlamps from the series of samples, according to the procedure described in Annex 9, paragraphs 2. and 4.**

## **2. FIRST SAMPLING**

**In the first sampling four headlamps are selected at random. The first sample of two is marked A, the second sample of two is marked B.**

2.1. The conformity is not contested

2.1.1. Following the sampling procedure shown in figure 1 of this annex the conformity of mass-produced headlamps shall not be contested if the deviations of the measured values of the headlamps in the unfavourable directions are:

2.1.1.1. sample A

A1:	one headlamp one headlamp	not more than	0 per cent 20 per cent
A2:	both headlamps but go to sample B	more than not more than	0 per cent 20 per cent

2.1.1.2. sample B

B1:	both headlamps		0 per cent
-----	----------------	--	------------

2.2. The conformity is contested

2.2.1. Following the sampling procedure shown in figure 1 of this annex the conformity of mass-produced headlamps shall be contested and the manufacturer requested to make his production meet the requirements (alignment) if the deviations of the measured values of the headlamps are:

2.2.1.1. sample A

A3:	one headlamp one headlamp but	not more than more than not more than	20 per cent 20 per cent 30 per cent
-----	-------------------------------------	---	---

2.2.1.2. sample B

B2:	in the case of A2 one headlamp but one headlamp	more than not more than not more than	0 per cent 20 per cent 20 per cent
B3:	in the case of A2 one headlamp one headlamp but	more than not more than	0 per cent 20 per cent 30 per cent

## 2.3. Approval withdrawn

Conformity shall be contested and paragraph 11. applied if, following the sampling procedure shown in figure 1 of this annex, the deviations of the measured values of the headlamps are:

## 2.3.1. sample A

A4:	one headlamp	not more than	20 per cent
	one headlamp	more than	30 per cent

A5:	both headlamps	more than	20 per cent
-----	----------------	-----------	-------------

## 2.3.2. sample B

B4:	in the case of A2		
	one headlamp	more than	0 per cent
	but	not more than	20 per cent
	one headlamp	more than	20 per cent

B5:	in the case of A2		
	both headlamps	more than	20 per cent

B6:	in the case of A2		
	one headlamp		0 per cent
	one headlamp	more than	30 per cent

## 3. REPEATED SAMPLING

In the case of A3, B2, B3 a repeated sampling, third sample C of two headlamps, selected from stock manufactured after alignment, is necessary within two months' time after the notification.

## 3.1. The conformity is not contested

## 3.1.1. Following the sampling procedure shown in figure 1 of this annex the conformity of mass-produced headlamps shall not be contested if the deviations of the measured values of the headlamps are:

## 3.1.1.1. sample C

C1:	one headlamp		0 per cent
	one headlamp	not more than	20 per cent

C2:	both headlamps	more than	0 per cent
	but	not more than	20 per cent

go to sample D

3.1.1.2. sample D

D1: in the case of C2  
both headlamps 0 per cent

3.2. The conformity is contested

3.2.1. Following the sampling procedure shown in figure 1 of this annex the conformity of mass-produced headlamps shall be contested and the manufacturer requested to make his production meet the requirements (alignment) if the deviations of the measured values of the headlamps are:

3.2.1.1. sample D

D2:	in the case of C2		
	one headlamp	more than	0 per cent
	but	not more than	20 per cent
	one headlamp	not more than	20 per cent

3.3. Approval withdrawn

Conformity shall be contested and paragraph 11. applied if, following the sampling procedure shown in figure 1 of this annex, the deviations of the measured values of the headlamps are:

3.3.1. sample C

C3:	one headlamp	not more than	20 per cent
	one headlamp	more than	20 per cent
C4:	both headlamps	more than	20 per cent

3.3.2. sample D

D3:	in the case of C2		
	one headlamp	0 or	more than
	one headlamp	more than	0 per cent
			20 per cent

Figure 1

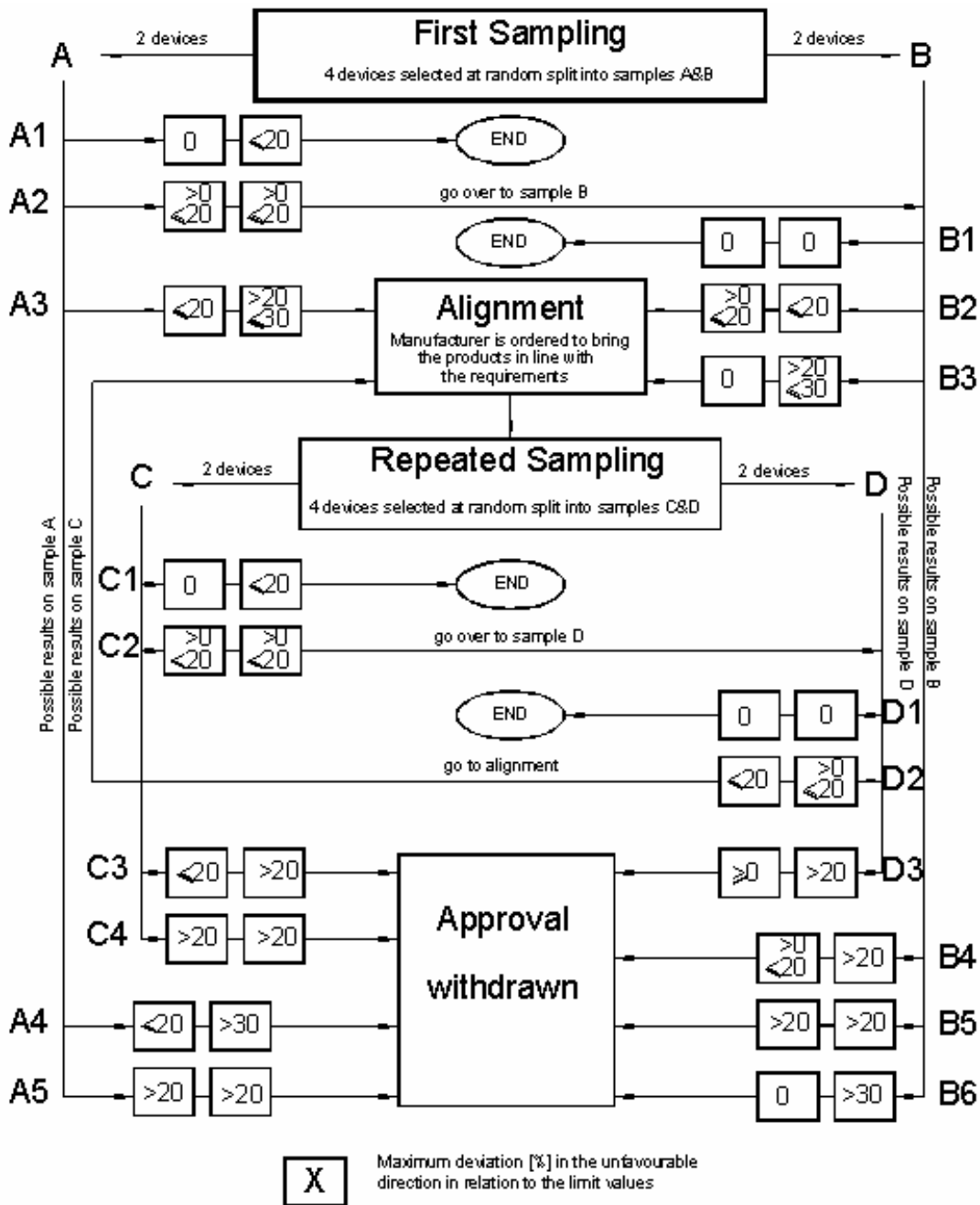

Annex 8

OVERVIEW OF OPERATIONAL PERIODS CONCERNING TEST FOR STABILITY OF  
PHOTOMETRIC PERFORMANCE

- Abbreviations: P: passing beam lamp  
D: driving beam lamp (D<sub>1</sub> + D<sub>2</sub> means two driving beams)  
F: front fog lamp  
- - - - - : means a cycle of 15 minutes off and 5 minutes lit.

All following grouped headlamps and front fog lamps together with the added class B marking symbols are given as examples and are not exhaustive.

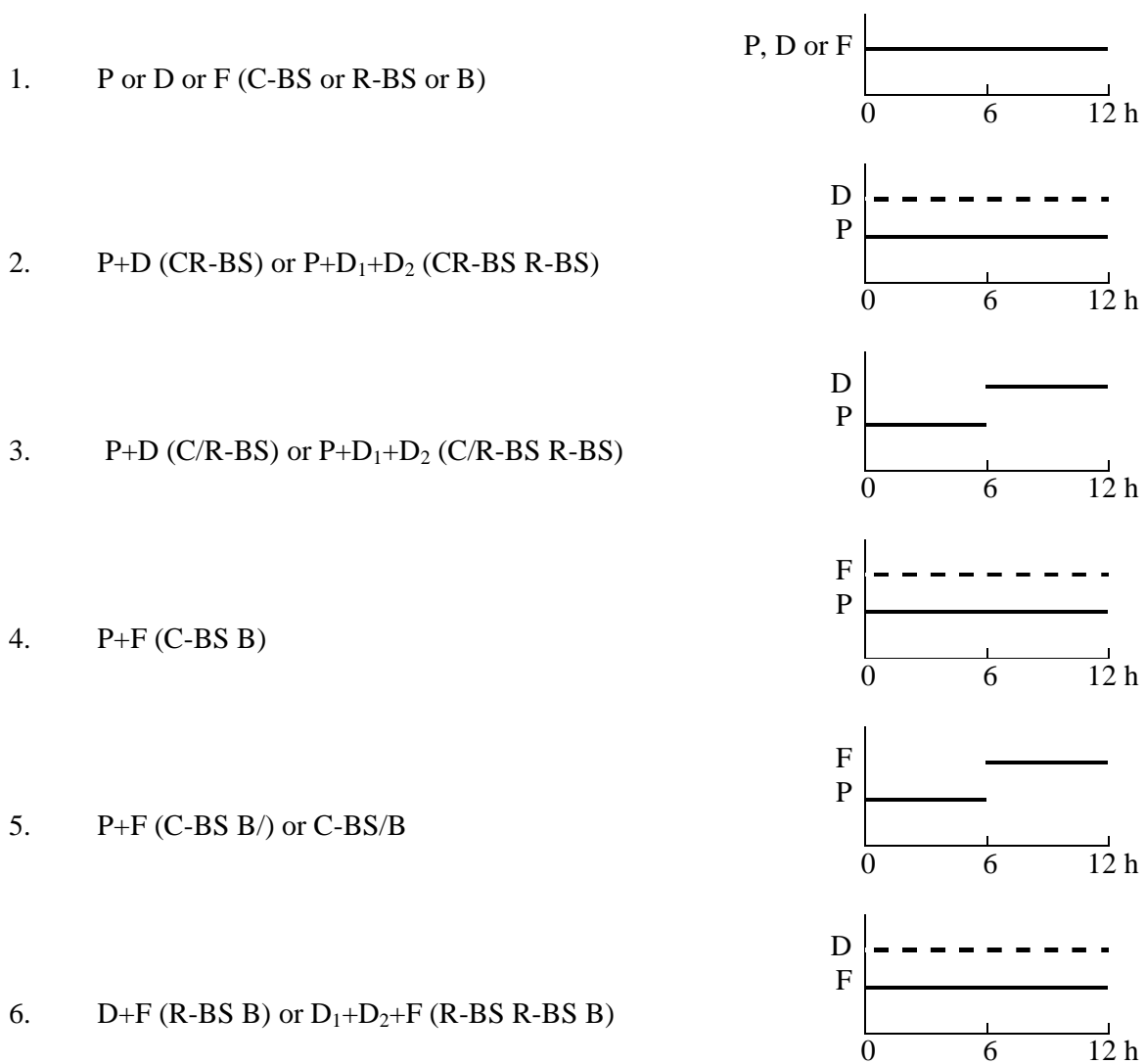

7. D+F (R-BS B/) or  $D_1+D_2+F$  (R-BS R-BS B/)

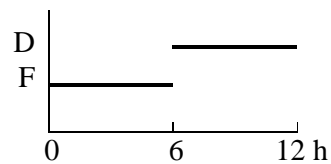

8. P+D+F (CR-BS B) or  $P+D_1+D_2+F$  (CR-BS R-BS B)

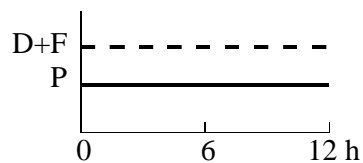

9. P+D+F (C/R-BS B) or  $P+D_1+D_2+F$  (C/R-BS R-BS B)

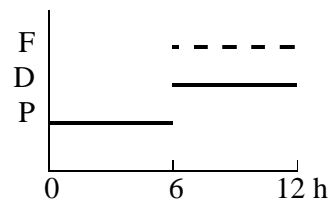

10. P+D+F (CR-BS B/) or  $P+D_1+D_2+F$  (CR-BS R-BS B/)

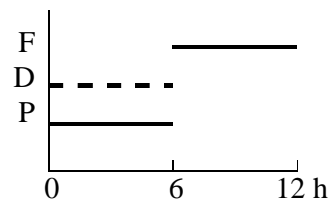

11. P+D+F (C/R-BS B/) or  $P+D_1+D_2+F$  (C/R-BS R-

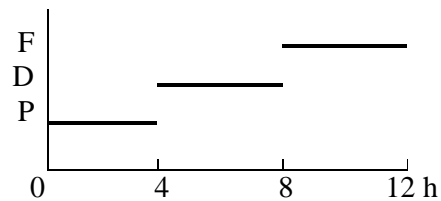



Annex 9

DEFINITION AND SHARPNESS OF THE "CUT-OFF" LINE FOR SYMMETRICAL PASSING-BEAM HEADLAMPS AND AIMING PROCEDURE BY MEANS OF THIS "CUT-OFF" LINE

1. GENERAL

1.1. The luminous intensity distribution of the symmetrical passing-beam headlamps shall incorporate a "cut-off" line which enables the symmetrical passing-beam headlamp to be adjusted correctly for the photometric measurements and for the aiming on the vehicle. The characteristics of the "cut-off" line shall comply with the requirements set out in paragraphs 2. to 4. below:

2. SHAPE OF THE "CUT-OFF" LINE

2.1. For visual adjustment of the symmetrical passing-beam headlamp the "cut-off" line shall provide a horizontal line for vertical adjustment of the symmetrical passing-beam headlamp extending to either side of the V-V line (see figure 1) as specified in paragraph 6.2.1. of this Regulation.

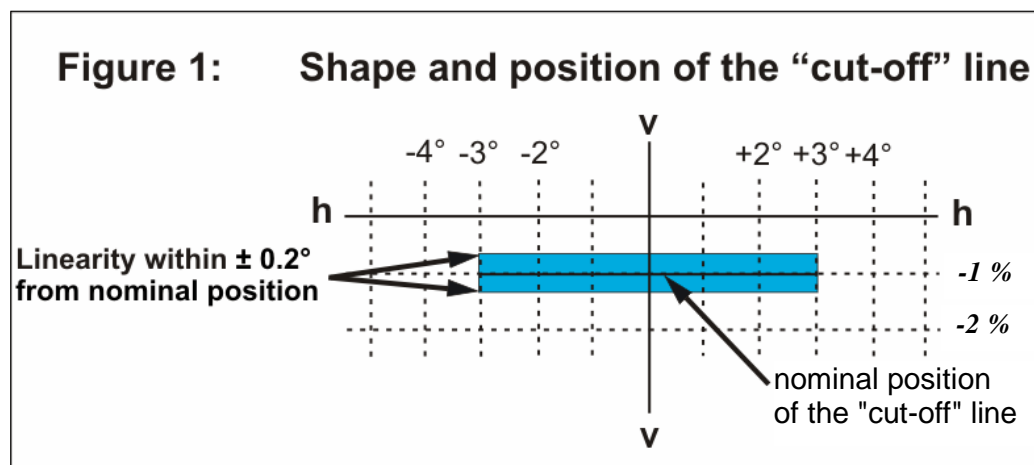

3. ADJUSTMENT OF THE SYMMETRICAL PASSING-BEAM HEADLAMP

3.1. Horizontal adjustment: the beam with the "cut-off" line shall be so positioned that the projected beam pattern appears approximately symmetrical to the V-V line.

3.2. Vertical adjustment: after horizontal adjustment of the symmetrical passing-beam headlamp according to paragraph 3.1. above, the vertical adjustment shall be performed in such a way that the beam with its "cut-off" line is moved upwards from the lower position until the "cut-off" line is situated at nominal vertical position. For nominal vertical adjustment the "cut-off" line is positioned on the V-V line at *1 per cent* below the h-h line.

If the horizontal part is not straight but slightly curved or inclined, the "cut-off" line shall not exceed the vertical range formed by two horizontal lines which are situated from 3° left to 3° right of the V-V line at 0.2° for Class B and 0.3° for Class A, C, **D and E** headlamps above and below the nominal position of the "cut-off" (see figure 1).

- 3.3. When the vertical adjustments of three different individuals differs by more than 0.2° for Class B and 0.3° for Class A, C, **D and E** head lamps, the horizontal part of the "cut-off" line is assumed not to provide sufficient linearity or sharpness for performing visual adjustment. In this case the quality of "cut-off" shall be tested instrumentally for compliance with requirements as follows.

#### 4. MEASUREMENT OF THE QUALITY OF "CUT-OFF"

- 4.1. Measurements shall be performed by vertically scanning through the horizontal part of the "cut-off" line in angular steps not exceeding 0.05°
- (a) at either a measurement distance of 10 m and a detector with a diameter of approximately 10 mm.
  - (b) or at a measurement distance of 25 m and a detector with a diameter of approximately 30 mm.

The measurement of the "cut-off" quality shall be considered acceptable if the requirements of the paragraph 4.1.2. of this annex shall comply with at least one measurement at 10 m or 25 m.

The measuring distance at which the test was determined shall be noted down in paragraph 9., Annex 1 "Communication form" of this Regulation.

The scanning is performed from its lower position upwards through the "cut-off" line along the vertical lines at **-3° to -1.5° and +1.5° to +3°** from the V-V line. When so measured, the quality of the "cut-off" line shall meet the following requirements:

- 4.1.1. Not more than one "cut-off" line shall be visible. 1/
- 4.1.2. Sharpness of "cut-off": if scanned vertically through the horizontal part of the "cut-off" line along the ± 2.5 -lines, the maximum value measured for:

$$G = (\log E_V - \log E_{(V+0.1^\circ)})$$

is called the sharpness factor G of the "cut-off" line. The value of G shall not be less than 0.13 for Class B and 0.08 for Classes A, C, **D and E**.

- 4.1.3. Linearity: the part of the "cut-off" line which serves for vertical adjustment shall be horizontal from 3°L to 3°R of the V-V line. This requirement is deemed to be met if the vertical positions of the inflection points according to paragraph 3.2. above at 3° left

---

1/ This paragraph will be amended, if an objective test method is available.

and right of the V-V line do not differ by more than  $0.2^\circ$  for Class B and  $0.3^\circ$  for Class A, C, **D and E** head lamps from the nominal position at the V-V line.

5. INSTRUMENTAL VERTICAL ADJUSTMENT

If the "cut-off" line complies with the above quality requirements, the vertical beam adjustment can be performed instrumentally. For this purpose the inflection point where  $d^2(\log E) / dv^2 = 0$  is positioned on the V-V line in its nominal position below the h-h-line. The movement for measuring and adjusting the "cut-off" line shall be upwards from below the nominal position.

Annex 10

**CENTRE OF REFERENCE**

**Diameter = a**

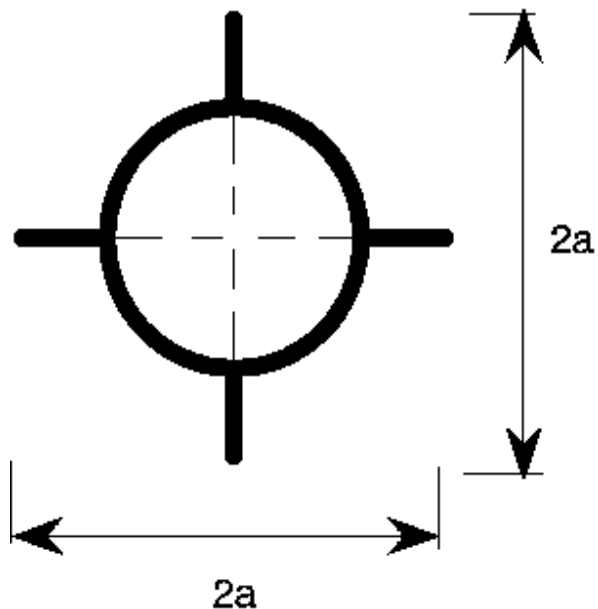

**a = 2 mm min.**

**This optional mark of the centre of reference shall be positioned on the lens at its intersection with the reference axis of the passing beam, and also on the lenses of the driving beams when they are neither grouped nor combined nor reciprocally incorporated with a passing beam.**

**The above drawing represents the mark of the centre of reference as projected on a plane substantially tangent to the lens about the centre of the circle. The lines constituting this mark may either be solid or dotted.**

**Annex 11**

**VOLTAGE MARKINGS**



**This marking must be placed on the main body of each headlamp containing only gas discharge light sources and ballast, and on each external part of the ballast.**

**The ballast(s) is(are) designed for a \*\* Volts network system.**

**This marking must be placed on the main body of each headlamp containing at least one gas discharge light source and ballast.**

**The ballast(s) is(are) designed for a \*\* Volts network system.**

**None of the filament lamps which the headlamp contains is designed for a 24 Volts network system.**

-----